

High temperature 30 A, 600 V TO220 thyristor SCRs

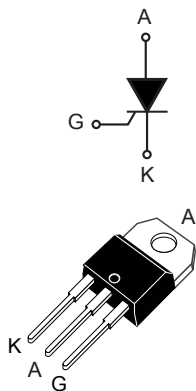

TO-220AB

Features

- High junction temperature: $T_j = 150\text{ °C}$
- High noise immunity $dV/dt = 1000\text{ V}/\mu\text{s}$ up to 150 °C
- Gate triggering current $I_{GT} = 15\text{ mA}$
- Peak off-state voltage $V_{DRM}/V_{RRM} = 600\text{ V}$
- High turn-on current rise $dI/dt = 100\text{ A}/\mu\text{s}$
- ECOPACK2 compliant

Applications

- General purpose AC line load switching
- Motorbike voltage regulator circuits
- Inrush current limiting circuits
- Motor control circuits and starters
- Heating resistor control, solid state relays
- Lighting

Description

Thanks to a junction temperature T_j up to 150 °C and a non-isolated TO-220 package, the TN3015H-6T offers high thermal performance operation up to 30 A rms.

The trade-off between the device's noise immunity ($dV/dt = 1000\text{ V}/\mu\text{s}$), its gate triggering current ($I_{GT} = 15\text{ mA}$) and its turn-on current rise ($dI/dt = 100\text{ A}/\mu\text{s}$) allows the design of robust and compact control circuits for voltage regulators in motorbikes and industrial drives, overvoltage crowbar protection, motor control circuits in power tools and kitchen appliances and inrush current limiting circuits.

Product status	
TN3015H-6T	
Product summary	
Order code	TN3015H-6T
Package	TO-220AB
V_{DRM}/V_{RRM}	600 V
T_j	150 °C
I_{GT}	15 mA

1 Characteristics

Table 1. Absolute maximum ratings (limiting values)

Symbol	Parameter		Value	Unit
$I_{T(RMS)}$	RMS on-state current (180 ° conduction angle)		$T_c = 127\text{ °C}$ 30	A
$I_{T(AV)}$	Average on-state current (180 ° conduction angle)		$T_c = 127\text{ °C}$ 19	A
			$T_c = 134\text{ °C}$ 15	
			$T_c = 141\text{ °C}$ 10	
I_{TSM}	Non repetitive surge peak on-state current (T_j initial = 25 °C)		$t_p = 8.3\text{ ms}$ 295	A
			$t_p = 10\text{ ms}$ 270	
I^2t	I^2t value for fusing, (T_j initial = 25 °C)		$t_p = 10\text{ ms}$ 364	A ² s
di/dt	$I_G = 2 \times I_{GT}$, $tr \leq 100\text{ ns}$ Critical rate of rise of on-state current	$f = 60\text{ Hz}$	$T_j = 25\text{ °C}$ 100	A/ μ s
V_{DRM}/V_{RRM}	Repetitive peak off-state voltage		600	V
V_{DSM}/V_{RSM}	Non Repetitive peak off-state voltage	$t_p = 10\text{ ms}$	$T_j = 25\text{ °C}$ $V_{DRM}/V_{RRM} + 100$	V
I_{GM}	Peak gate current	$t_p = 20\text{ }\mu\text{s}$	$T_j = 150\text{ °C}$ 4	A
$P_{G(AV)}$	Average gate power dissipation		$T_j = 150\text{ °C}$ 1	W
V_{RGM}	Maximum peak reverse gate voltage		$T_j = 25\text{ °C}$ 5	V
T_{stg}	Storage junction temperature range		-40 to +150	°C
T_j	Maximum operating junction temperature		-40 to +150	°C
T_l	Maximum lead temperature soldering during 10 s		260	°C

Table 2. Electrical characteristics ($T_j = 25\text{ °C}$ unless otherwise specified)

Symbol	Test conditions		Value	Unit	
I_{GT}	$V_D = 12\text{ V}$, $R_L = 33\text{ }\Omega$		Typ.	6	mA
			Max.	15	
V_{GT}			Max.	1.3	V
V_{GD}	$V_D = V_{DRM}$, $R_L = 3.3\text{ k}\Omega$	$T_j = 150\text{ °C}$	Min.	0.15	V
I_H	$I_T = 500\text{ mA}$, gate open		Max.	60	mA
I_L	$I_G = 1.2 \times I_{GT}$		Max.	75	mA
dV/dt	$V_D = 402\text{ V}$, gate open	$T_j = 150\text{ °C}$	Min.	1000	V/ μ s
t_{gt}	$I_T = 60\text{ A}$, $V_D = 600\text{ V}$, $I_G = 100\text{ mA}$, $(di_G/dt)_{max} = 0.2\text{ A}/\mu\text{s}$		Typ.	1.9	μ s
t_q	$I_T = 30\text{ A}$, $V_D = 402\text{ V}$, $(di/dt)_{off} = 30\text{ A}/\mu\text{s}$, $V_R = 25\text{ V}$, $dV_D/dt = 50\text{ V}/\mu\text{s}$	$T_j = 150\text{ °C}$	Typ.	80	μ s

Table 3. Static characteristics

Symbol	Test conditions			Value	Unit
V_{TM}	$I_{TM} = 60\text{ A}$, $t_p = 380\ \mu\text{s}$	$T_j = 25\text{ }^\circ\text{C}$	Max.	1.6	V
V_{TO}	Threshold voltage	$T_j = 150\text{ }^\circ\text{C}$	Max.	0.84	
R_D	Dynamic resistance	$T_j = 150\text{ }^\circ\text{C}$	Max.	14	m Ω
I_{DRM} , I_{RRM}	$V_D = V_{DRM}$; $V_R = V_{RRM}$	$T_j = 25\text{ }^\circ\text{C}$	Max.	10	μA
		$T_j = 150\text{ }^\circ\text{C}$		5	mA

Table 4. Thermal parameters

Symbol	Parameter		Value	Unit
$R_{th(j-c)}$	Junction to case (DC)	Max.	0.85	$^\circ\text{C/W}$
$R_{th(j-a)}$	Junction to ambient	Typ.	60	

1.1 Characteristics curves

Figure 1. Maximum power dissipation versus average on-state current

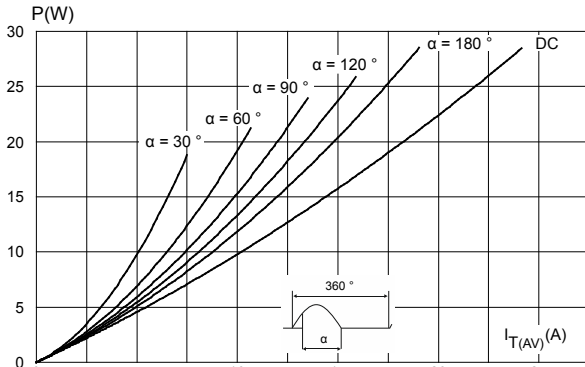

Figure 2. Average and DC on-state current versus case temperature

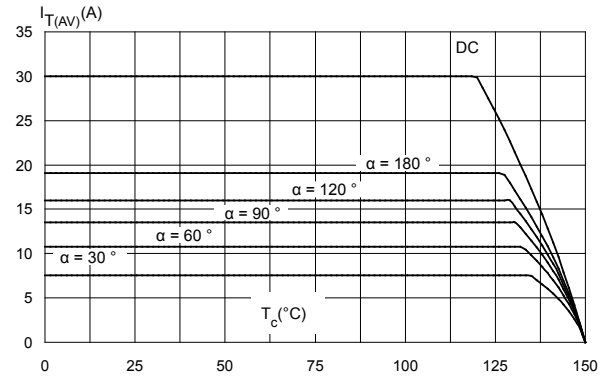

Figure 3. Average and D.C. on state current versus ambient temperature

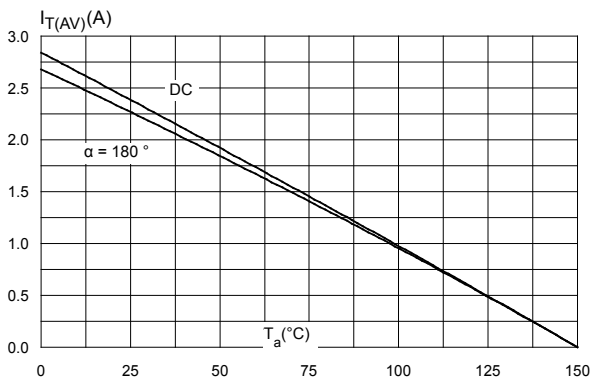

Figure 4. On-state characteristics (maximum values)

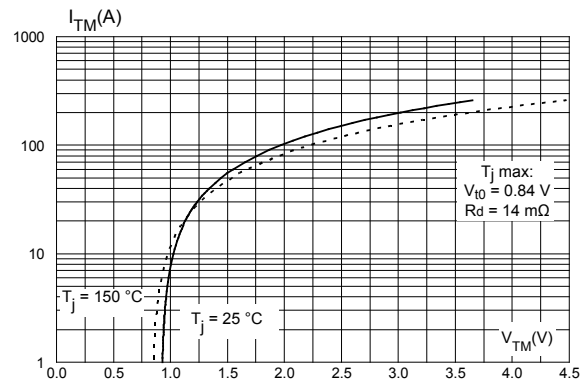

Figure 5. Relative variation of thermal impedance junction to case and junction to ambient versus pulse duration

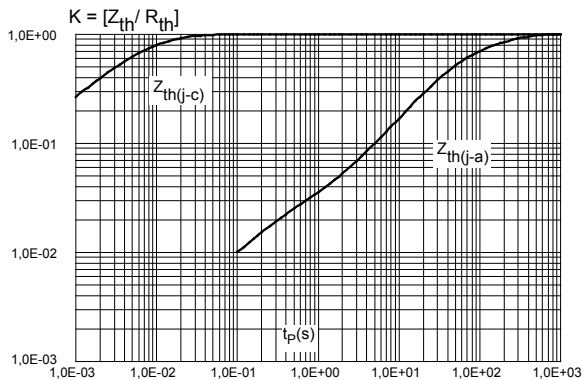

Figure 6. Relative variation of gate trigger current and gate voltage versus junction temperature (typical values)

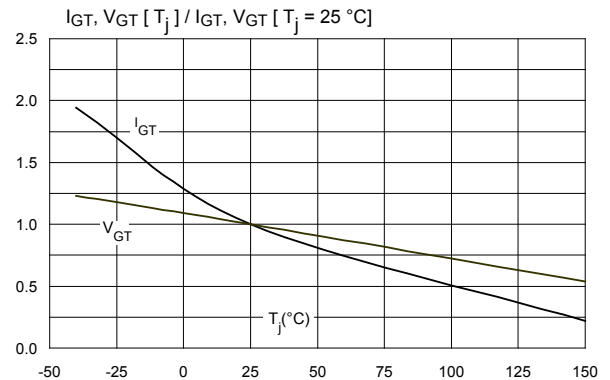

Figure 7. Relative variation of holding and latching current versus junction temperature (typical values)

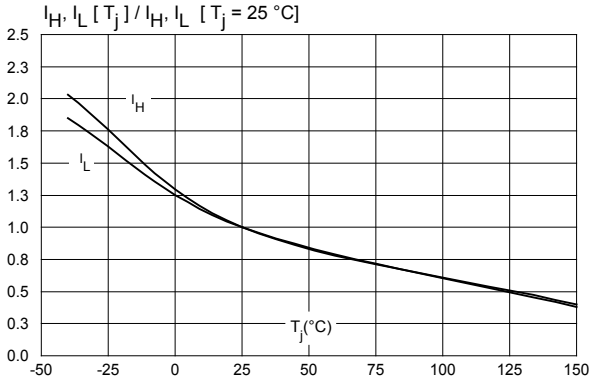

Figure 8. Relative variation of static dV/dt immunity versus junction temperature (typical values)

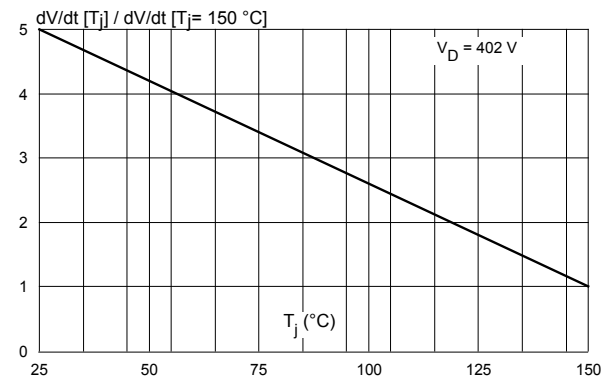

Figure 9. Surge peak on-state current versus number of cycles

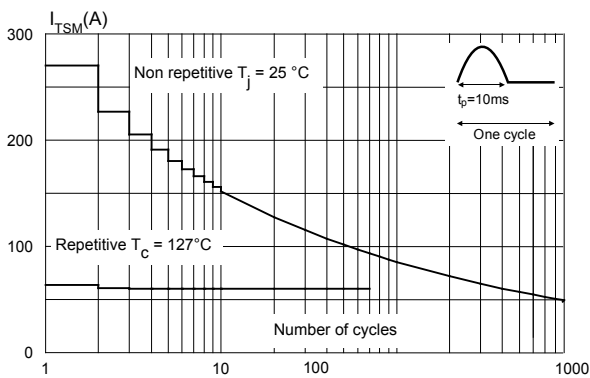

Figure 10. Non repetitive surge peak on-state current for a sinusoidal pulse with width $t_p < 10\text{ ms}$

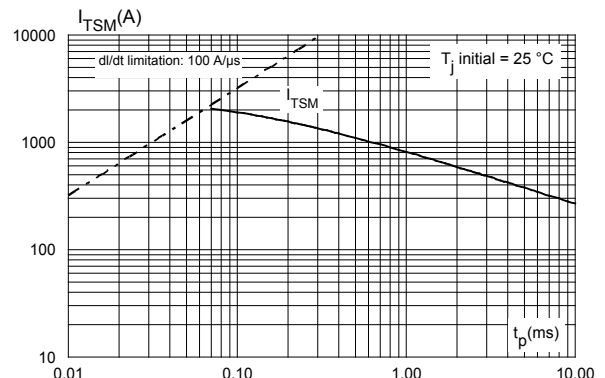
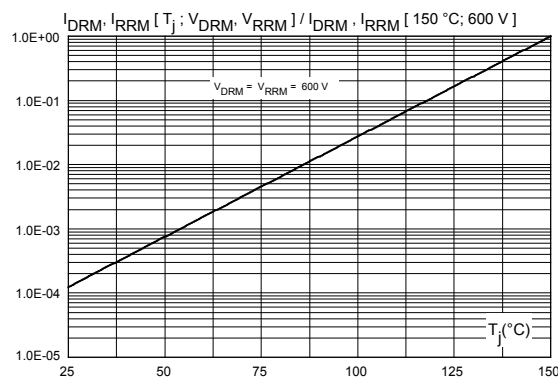

Figure 11. Relative variation of leakage current versus junction temperature



2 Package information

In order to meet environmental requirements, ST offers these devices in different grades of **ECOPACK** packages, depending on their level of environmental compliance. ECOPACK specifications, grade definitions and product status are available at: www.st.com. ECOPACK is an ST trademark.

2.1 TO-220AB package information

- Molding compound resin is halogen-free and meets flammability standard UL94 level 0
- Lead-free package leads finishing
- **ECOPACK2** compliant
- Recommended torque: 0.4 to 0.6 N.m

Figure 12. TO-220AB package outline

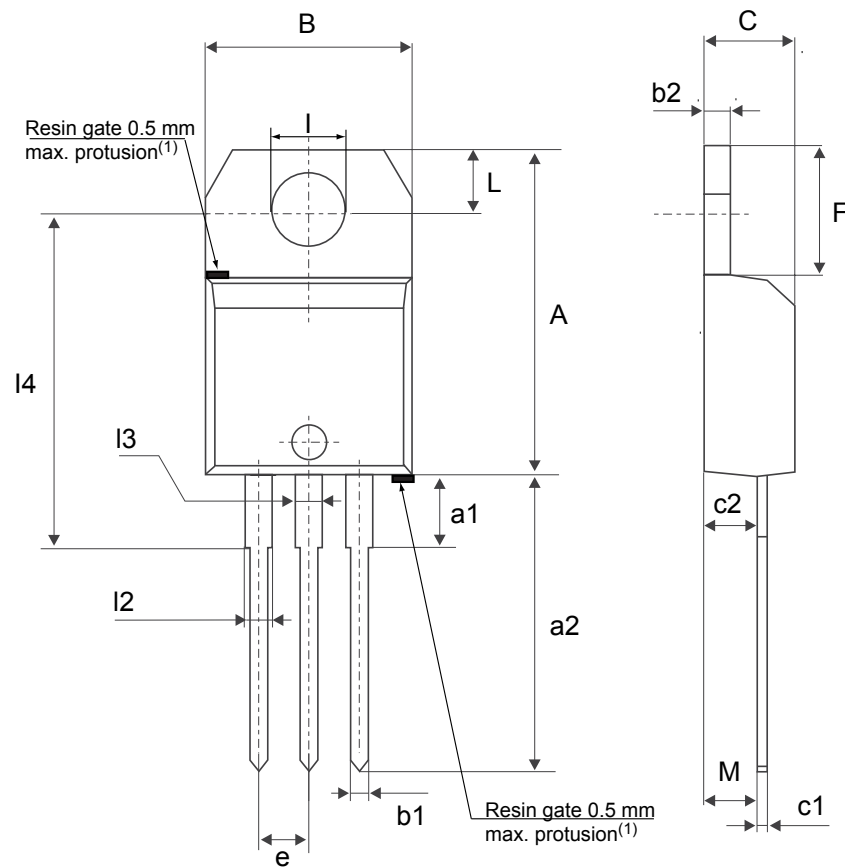

(1) Resin gate position accepted in one of the two positions or in the symmetrical opposites.

Table 5. TO-220AB package mechanical data

Ref.	Dimensions					
	Millimeters			Inches ⁽¹⁾		
	Min.	Typ.	Max.	Min.	Typ.	Max.
A	15.20		15.90	0.5984		0.6260
a1		3.75			0.1476	
a2	13.00		14.00	0.5118		0.5512
B	10.00		10.40	0.3937		0.4094
b1	0.61		0.88	0.0240		0.0346
b2	1.23		1.32	0.0484		0.0520
C	4.40		4.60	0.1732		0.1811
c1	0.49		0.70	0.0193		0.0276
c2	2.40		2.72	0.0945		0.1071
e	2.40		2.70	0.0945		0.1063
F	6.20		6.60	0.2441		0.2598
l	3.73		3.88	0.1469		0.1528
L	2.65		2.95	0.1043		0.1161
l2	1.14		1.70	0.0449		0.0669
l3	1.14		1.70	0.0449		0.0669
l4	15.80	16.40	16.80	0.6220	0.6457	0.6614
M		2.6			0.1024	

1. Inch dimensions are for reference only.

3 Ordering information

Figure 13. Ordering information scheme

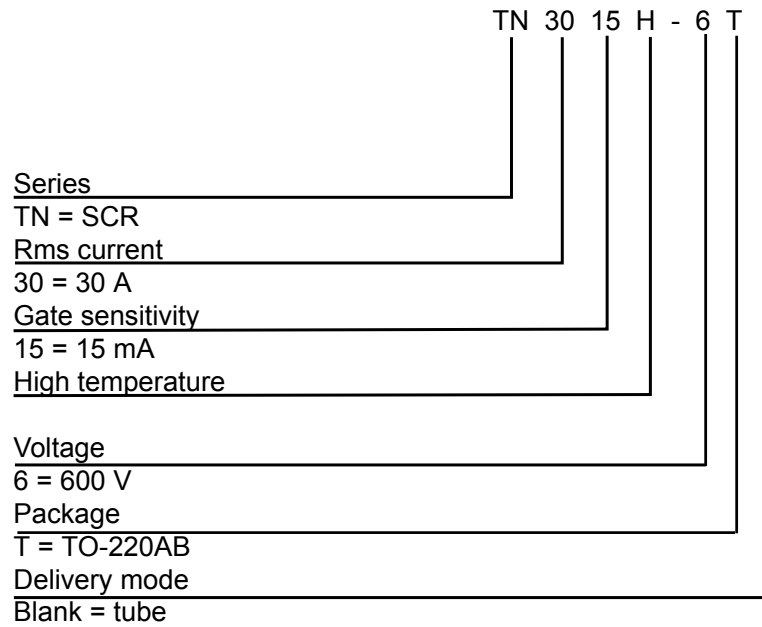

Table 6. Ordering information

Order code	Marking	Package	Weight	Base qty.	Delivery mode
TN3015H-6T	TN3015H6	TO-220AB	2.3 g	50	Tube

Revision history

Table 7. Document revision history

Date	Revision	Changes
22-May-2019	1	Initial release.
08-Jul-2019	2	Updated cover image.

IMPORTANT NOTICE – PLEASE READ CAREFULLY

STMicroelectronics NV and its subsidiaries (“ST”) reserve the right to make changes, corrections, enhancements, modifications, and improvements to ST products and/or to this document at any time without notice. Purchasers should obtain the latest relevant information on ST products before placing orders. ST products are sold pursuant to ST’s terms and conditions of sale in place at the time of order acknowledgement.

Purchasers are solely responsible for the choice, selection, and use of ST products and ST assumes no liability for application assistance or the design of Purchasers’ products.

No license, express or implied, to any intellectual property right is granted by ST herein.

Resale of ST products with provisions different from the information set forth herein shall void any warranty granted by ST for such product.

ST and the ST logo are trademarks of ST. For additional information about ST trademarks, please refer to www.st.com/trademarks. All other product or service names are the property of their respective owners.

Information in this document supersedes and replaces information previously supplied in any prior versions of this document.

© 2019 STMicroelectronics – All rights reserved

X-ON Electronics

Largest Supplier of Electrical and Electronic Components

Click to view similar products for [SCRs](#) category:

Click to view products by [STMicroelectronics](#) manufacturer:

Other Similar products are found below :

[NTE5428](#) [T1500N16TOF VT](#) [T880N16TOF](#) [TT162N16KOF-A](#) [TT162N16KOF-K](#) [TT330N16AOF](#) [VS-22RIA20](#) [VS-2N685](#) [057219R](#)
[T1190N16TOF VT](#) [T1220N22TOF VT](#) [T201N70TOH](#) [T700N22TOF](#) [T830N18TOF](#) [TT250N12KOF-K](#) [VS-110RKI40](#) [NTE5427](#) [NTE5442](#)
[T2160N28TOF VT](#) [TT251N16KOF-K](#) [VS-22RIA100](#) [VS-16RIA40](#) [TD250N16KOF-A](#) [VS-ST110S16P0](#) [T930N36TOF VT](#) [T2160N24TOF](#)
[VT](#) [T1190N18TOF VT](#) [T1590N28TOF VT](#) [2N1776A](#) [T590N14TOF](#) [NTE5375](#) [NTE5460](#) [NTE5481](#) [NTE5512](#) [NTE5514](#) [NTE5518](#)
[NTE5519](#) [NTE5529](#) [NTE5553](#) [NTE5555](#) [NTE5557](#) [NTE5567](#) [NTE5570](#) [NTE5572](#) [NTE5574](#) [NTE5576](#) [NTE5578](#) [NTE5579](#) [NTE5589](#)
[NTE5592](#)