

## Rail-to-rail 1.1 V dual and quad nanopower comparators

Datasheet - production data

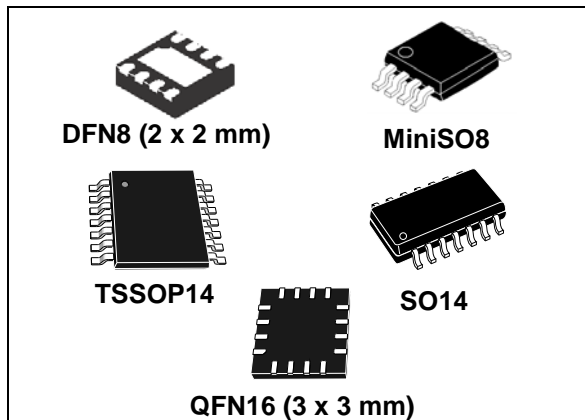

### Related product

- See the TS881 datasheet for single operator with smaller package.

### Applications

- Portable systems
- Signal conditioning
- Medical
- Automotive

### Description

The TS882 is a dual and the TS884 device a quad comparator featuring ultra-low supply current (220 nA typical per operator with output high,  $V_{CC} = 1.2$  V, no load) with rail-to-rail input and output capability. The performance of these comparators allows them to be used in a wide range of portable applications. The TS882 and TS884 devices minimize battery supply leakage and therefore enhance battery lifetime.

Operating from 1.1 to 5.5 V supply voltage, these comparators can be used over a wide temperature range (-40 to +125 °C) keeping the current consumption at an ultra-low level.

### Features

- Ultra-low current consumption: 220 nA typ./op.
- Propagation delay: 2  $\mu$ s typ.
- Rail-to-rail inputs
- Push-pull outputs
- Supply operation from 1.1 V to 5.5 V
- Wide temperature range: -40 to +125 °C
- ESD tolerance: 8 kV HBM / 300 V MM
- Dual version available in MiniSO8 and DFN8 (2 x 2 mm) package
- Quad version available in SO14, TSSOP14 and QFN16 3 x 3 mm package

**Table 1. Device summary**

Order code	Temperature range	Package	Packaging	Marking
TS882IST	-40 to +125 °C	MiniSO8	Tape and reel	K514
TS882IYST <sup>(1)</sup>		MiniSO8 (Automotive grade)		K524
TS882IQ2T		DFN8 2 x 2 mm		K56
TS884IDT	-40 to +125 °C	SO14	Tape and reel	S884I
TS884IPT		TSSOP14		S884I
TS884IQ4T		QFN16 3 x 3 mm		K514

1. Qualified and characterized according to AEC Q100 and Q003 or equivalent, advanced screening according to AEC Q001 & Q002 or equivalent

# Contents

<b>1</b>	<b>Pin description</b> .....	<b>3</b>
<b>2</b>	<b>Absolute maximum ratings and operating conditions</b> .....	<b>4</b>
<b>3</b>	<b>Electrical characteristics</b> . . . . .	<b>5</b>
<b>4</b>	<b>Package information</b> .....	<b>15</b>
4.1	DFN8 2 x 2 mm package information .....	16
4.2	MiniSO8 package information .....	18
4.3	SO14 package information .....	19
4.4	QFN16 3 x 3 package information .....	20
4.5	TSSOP14 package information .....	23
<b>5</b>	<b>Revision history</b> .....	<b>24</b>

# 1 Pin description

Figure 1. Pin connections TS882 (top view)

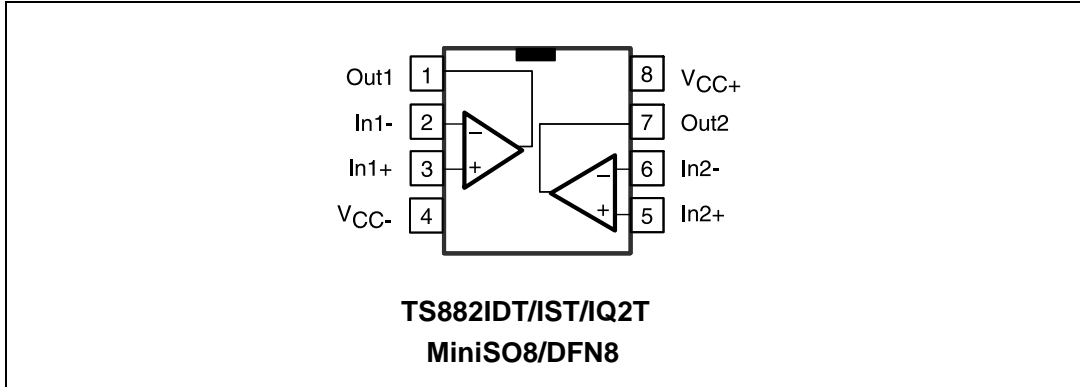
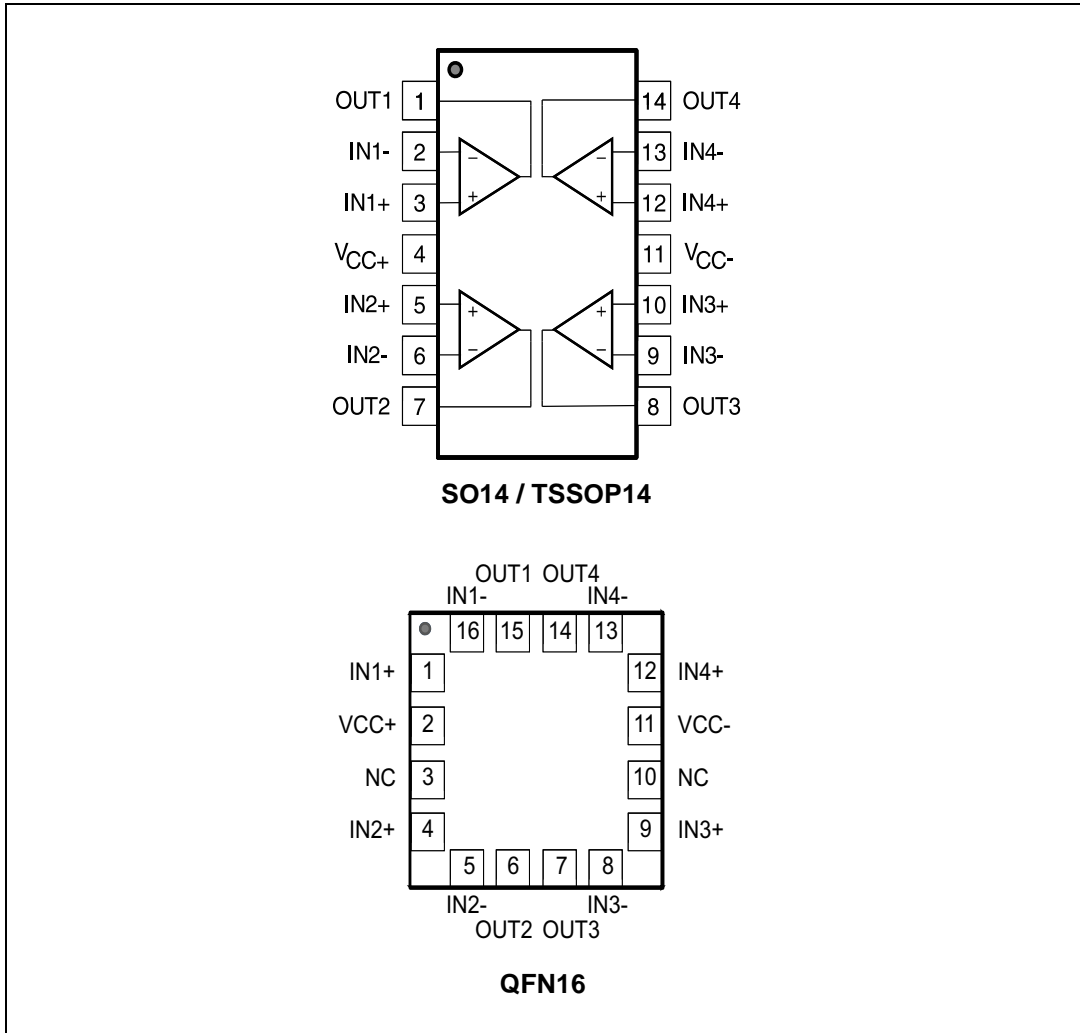

Figure 2. Pin connections TS884 (top view)



## 2 Absolute maximum ratings and operating conditions

**Table 2. Absolute maximum ratings**

Symbol	Parameter	Value	Unit
$V_{CC}$	Supply voltage <sup>(1)</sup>	6	V
$V_{ID}$	Differential input voltage <sup>(2)</sup>	±6	V
$V_{IN}$	Input voltage range	$(V_{CC-}) - 0.3$ to $(V_{CC+}) + 0.3$	V
$R_{THJA}$	Thermal resistance junction to ambient (TS882) <sup>(3)</sup> MiniSO8	190	°C/W
	DFN8 2 x 2 mm	57	
	Thermal resistance junction to ambient (TS884) <sup>(3)</sup> SO14	105	
	TSSOP14	100	
	QFN16 3 x 3 mm	45	
$T_{STG}$	Storage temperature	-65 to +150	°C
$T_J$	Junction temperature	150	°C
$T_{LEAD}$	Lead temperature (soldering 10 seconds)	260	°C
ESD	Human body model (HBM) <sup>(4)</sup>	8	kV
	Machine model (MM) <sup>(5)</sup>	300	V
	Charged device model (CDM) <sup>(6)</sup>	1300	
	Latch-up immunity	200	mA

1. All voltage values, except differential voltages, are referenced to  $V_{CC-}$ .  $V_{CC}$  is defined as the difference between  $V_{CC+}$  and  $V_{CC-}$ .
2. The magnitude of input and output voltages must never exceed the supply rail ±0.3 V.
3. Short-circuits can cause excessive heating. These values are typical.
4. According to JEDEC standard JESD22-A114F.
5. According to JEDEC standard JESD22-A115A.
6. According to ANSI/ESD STM5.3.1.

**Table 3. Operating conditions**

Symbol	Parameter	Value	Unit
$T_{oper}$	Operating temperature range	-40 to +125	°C
$V_{CC}$	Supply voltage -40 °C < $T_{amb}$ < +125 °C	1.1 to 5.5	V
$V_{ICM}$	Common mode input voltage range -40 °C < $T_{amb}$ < +85 °C -40 °C < $T_{amb}$ < +125 °C	$(V_{CC-}) - 0.2$ to $(V_{CC+}) + 0.2$ $(V_{CC-})$ to $(V_{CC+}) + 0.2$	V

### 3 Electrical characteristics

Table 4.  $V_{CC} = +1.2\text{ V}$ ,  $T_{amb} = +25\text{ °C}$ ,  $V_{ICM} = V_{CC}/2$  (unless otherwise specified)<sup>(1)</sup>

Symbol	Parameter	Test conditions	Min.	Typ.	Max.	Unit
$V_{IO}$	Input offset voltage <sup>(2)</sup>	$T_{amb} = +25\text{ °C}$ $-40\text{ °C} < T_{amb} < +125\text{ °C}$	-6	1	6	mV
$\Delta V_{IO}$	Input offset voltage drift	$-40\text{ °C} < T_{amb} < +125\text{ °C}$		3		$\mu\text{V}/\text{°C}$
$V_{HYST}$	Input hysteresis voltage <sup>(3)</sup>	$T_{amb} = +25\text{ °C}$ $-40\text{ °C} < T_{amb} < +125\text{ °C}$	1.5	2.4	4.2	mV
$I_{IO}$	Input offset current <sup>(4)</sup>	$T_{amb} = +25\text{ °C}$ $-40\text{ °C} < T_{amb} < +125\text{ °C}$			10 100	pA
$I_{IB}$	Input bias current <sup>(4)</sup>	$T_{amb} = +25\text{ °C}$ $-40\text{ °C} < T_{amb} < +125\text{ °C}$		1	10 100	pA
$I_{CC}$	Supply current per operator	No load, output low, $V_{ID} = -0.1\text{ V}$ $-40\text{ °C} < T_{amb} < +125\text{ °C}$  No load, output high, $V_{ID} = +0.1\text{ V}$ $-40\text{ °C} < T_{amb} < +125\text{ °C}$		300 220	450 350	nA
$I_{SC}$	Short-circuit current	Source Sink		1.0 1.7		mA
$V_{OH}$	Output voltage high	$I_{source} = 0.2\text{ mA}$ $-40\text{ °C} < T_{amb} < +85\text{ °C}$ $-40\text{ °C} < T_{amb} < +125\text{ °C}$	1.13 1.10 1.00	1.15		V
$V_{OL}$	Output voltage low	$I_{sink} = 0.2\text{ mA}$ $-40\text{ °C} < T_{amb} < +85\text{ °C}$ $-40\text{ °C} < T_{amb} < +125\text{ °C}$		35	50 60 70	mV
CMRR	Common mode rejection ratio	$0 < V_{ICM} < V_{CC}$ $-40\text{ °C} < T_{amb} < +125\text{ °C}$	50	68		dB
$T_{PLH}$	Propagation delay (low to high)	$f = 1\text{ kHz}$ , $C_L = 30\text{ pF}$ , $R_L = 1\text{ M}\Omega$ Overdrive = 10 mV $-40\text{ °C} < T_{amb} < +125\text{ °C}$  Overdrive = 100 mV $-40\text{ °C} < T_{amb} < +125\text{ °C}$		5.5 2.1	11 13 3.1 3.4	$\mu\text{s}$
$T_{PHL}$	Propagation delay (high to low)	$f = 1\text{ kHz}$ , $C_L = 30\text{ pF}$ , $R_L = 1\text{ M}\Omega$ Overdrive = 10 mV $-40\text{ °C} < T_{amb} < +125\text{ °C}$  Overdrive = 100 mV $-40\text{ °C} < T_{amb} < +125\text{ °C}$		5.1 1.9	8 10 2.6 3.1	$\mu\text{s}$
$T_R$	Rise time (10% to 90%)	$C_L = 30\text{ pF}$ , $R_L = 1\text{ M}\Omega$		100		ns

Table 4.  $V_{CC} = +1.2\text{ V}$ ,  $T_{amb} = +25\text{ }^{\circ}\text{C}$ ,  $V_{ICM} = V_{CC}/2$  (unless otherwise specified)<sup>(1)</sup> (continued)

Symbol	Parameter	Test conditions	Min.	Typ.	Max.	Unit
$T_F$	Fall time (90% to 10%)	$C_L = 30\text{ pF}$ , $R_L = 1\text{ M}\Omega$		110		ns
$T_{ON}$	Power-up time			1.1	1.7	ms

1. All values over the temperature range are guaranteed through correlation and simulation. No production test is performed at the temperature range limits.
2. The offset is defined as the average value of positive and negative trip points (input voltage differences requested to change the output state in each direction).
3. The hysteresis is a built-in feature of the TS882 device. It is defined as the voltage difference between the trip points.
4. Maximum values include unavoidable inaccuracies of the industrial tests.

Table 5.  $V_{CC} = +2.7\text{ V}$ ,  $T_{amb} = +25\text{ }^{\circ}\text{C}$ ,  $V_{ICM} = V_{CC}/2$  (unless otherwise specified)<sup>(1)</sup>

Symbol	Parameter	Test conditions	Min.	Typ.	Max.	Unit
$V_{IO}$	Input offset voltage <sup>(2)</sup>	$T_{amb} = +25\text{ }^{\circ}\text{C}$ $-40\text{ }^{\circ}\text{C} < T_{amb} < +125\text{ }^{\circ}\text{C}$	-6	1	6	mV
$\Delta V_{IO}$	Input offset voltage drift	$-40\text{ }^{\circ}\text{C} < T_{amb} < +125\text{ }^{\circ}\text{C}$		3		$\mu\text{V}/^{\circ}\text{C}$
$V_{HYST}$	Input hysteresis voltage <sup>(3)</sup>	$T_{amb} = +25\text{ }^{\circ}\text{C}$ $-40\text{ }^{\circ}\text{C} < T_{amb} < +125\text{ }^{\circ}\text{C}$	1.6	2.7	4.2	mV
$I_{IO}$	Input offset current <sup>(4)</sup>	$T_{amb} = +25\text{ }^{\circ}\text{C}$ $-40\text{ }^{\circ}\text{C} < T_{amb} < +125\text{ }^{\circ}\text{C}$			10 100	pA
$I_{IB}$	Input bias current <sup>(4)</sup>	$T_{amb} = +25\text{ }^{\circ}\text{C}$ $-40\text{ }^{\circ}\text{C} < T_{amb} < +125\text{ }^{\circ}\text{C}$		1	10 100	pA
$I_{CC}$	Supply current per operator	No load, output low, $V_{ID} = -0.1\text{ V}$ $-40\text{ }^{\circ}\text{C} < T_{amb} < +125\text{ }^{\circ}\text{C}$  No load, output high, $V_{ID} = +0.1\text{ V}$ $-40\text{ }^{\circ}\text{C} < T_{amb} < +125\text{ }^{\circ}\text{C}$		310 220	450 350	nA
$I_{SC}$	Short-circuit current	Source Sink		10 13		mA
$V_{OH}$	Output voltage high	$I_{source} = 2\text{ mA}$ $-40\text{ }^{\circ}\text{C} < T_{amb} < +85\text{ }^{\circ}\text{C}$ $-40\text{ }^{\circ}\text{C} < T_{amb} < +125\text{ }^{\circ}\text{C}$	2.48 2.40 2.10	2.51		V
$V_{OL}$	Output voltage low	$I_{sink} = 2\text{ mA}$ $-40\text{ }^{\circ}\text{C} < T_{amb} < +85\text{ }^{\circ}\text{C}$ $-40\text{ }^{\circ}\text{C} < T_{amb} < +125\text{ }^{\circ}\text{C}$		130	210 230 310	mV
CMRR	Common mode rejection ratio	$0 < V_{ICM} < V_{CC}$ $-40\text{ }^{\circ}\text{C} < T_{amb} < +125\text{ }^{\circ}\text{C}$	55	74		dB
$T_{PLH}$	Propagation delay (low to high)	$f = 1\text{ kHz}$ , $C_L = 30\text{ pF}$ , $R_L = 1\text{ M}\Omega$ Overdrive = 10 mV $-40\text{ }^{\circ}\text{C} < T_{amb} < +125\text{ }^{\circ}\text{C}$  Overdrive = 100 mV $-40\text{ }^{\circ}\text{C} < T_{amb} < +125\text{ }^{\circ}\text{C}$		6.4 2.3	12 14 3.0 3.7	$\mu\text{s}$

Table 5.  $V_{CC} = +2.7\text{ V}$ ,  $T_{amb} = +25\text{ °C}$ ,  $V_{ICM} = V_{CC}/2$  (unless otherwise specified)<sup>(1)</sup> (continued)

Symbol	Parameter	Test conditions	Min.	Typ.	Max.	Unit
$T_{PHL}$	Propagation delay (high to low)	$f = 1\text{ kHz}$ , $C_L = 30\text{ pF}$ , $R_L = 1\text{ M}\Omega$ Overdrive = 10 mV $-40\text{ °C} < T_{amb} < +125\text{ °C}$		6.4	12 14	$\mu\text{s}$
		Overdrive = 100 mV $-40\text{ °C} < T_{amb} < +125\text{ °C}$		2.2	3.0 3.7	
$T_R$	Rise time (10% to 90%)	$C_L = 30\text{ pF}$ , $R_L = 1\text{ M}\Omega$		120		ns
$T_F$	Fall time (90% to 10%)	$C_L = 30\text{ pF}$ , $R_L = 1\text{ M}\Omega$		130		ns
$T_{ON}$	Power-up time			1.1	1.7	ms

1. All values over the temperature range are guaranteed through correlation and simulation. No production test is performed at the temperature range limits.
2. The offset is defined as the average value of positive and negative trip points (input voltage differences requested to change the output state in each direction).
3. The hysteresis is a built-in feature of the TS882. It is defined as the voltage difference between the trip points.
4. Maximum values include unavoidable inaccuracies of the industrial tests.

Table 6.  $V_{CC} = +5\text{ V}$ ,  $T_{amb} = +25\text{ °C}$ ,  $V_{ICM} = V_{CC}/2$  (unless otherwise specified)<sup>(1)</sup>

Symbol	Parameter	Test conditions	Min.	Typ.	Max.	Unit
$V_{IO}$	Input offset voltage <sup>(2)</sup>	$T_{amb} = +25\text{ °C}$ $-40\text{ °C} < T_{amb} < +125\text{ °C}$	-6	1	6	mV
$\Delta V_{IO}$	Input offset voltage drift	$-40\text{ °C} < T_{amb} < +125\text{ °C}$		3		$\mu\text{V}/\text{°C}$
$V_{HYST}$	Input hysteresis voltage <sup>(3)</sup>	$T_{amb} = +25\text{ °C}$ $-40\text{ °C} < T_{amb} < +125\text{ °C}$	1.6	3.1	4.2	mV
$I_{IO}$	Input offset current <sup>(4)</sup>	$T_{amb} = +25\text{ °C}$ $-40\text{ °C} < T_{amb} < +125\text{ °C}$			10 100	pA
$I_{IB}$	Input bias current <sup>(4)</sup>	$T_{amb} = +25\text{ °C}$ $-40\text{ °C} < T_{amb} < +125\text{ °C}$		1	10 100	pA
$I_{CC}$	Supply current per operator	No load, output low, $V_{ID} = -0.1\text{ V}$ $-40\text{ °C} < T_{amb} < +125\text{ °C}$		350	500	nA
		No load, output high, $V_{ID} = +0.1\text{ V}$ $-40\text{ °C} < T_{amb} < +125\text{ °C}$		250	400	
$I_{SC}$	Short-circuit current	Source Sink		32 32		mA
$V_{OH}$	Output voltage high	$I_{source} = 2\text{ mA}$ $-40\text{ °C} < T_{amb} < +85\text{ °C}$ $-40\text{ °C} < T_{amb} < +125\text{ °C}$	4.86 4.75 4.60	4.88		V
$V_{OL}$	Output voltage low	$I_{sink} = 2\text{ mA}$ $-40\text{ °C} < T_{amb} < +85\text{ °C}$ $-40\text{ °C} < T_{amb} < +125\text{ °C}$		90	130 170 280	mV
CMRR	Common mode rejection ratio	$0 < V_{ICM} < V_{CC}$ $-40\text{ °C} < T_{amb} < +125\text{ °C}$	55	78		dB

Table 6.  $V_{CC} = +5\text{ V}$ ,  $T_{amb} = +25\text{ °C}$ ,  $V_{ICM} = V_{CC}/2$  (unless otherwise specified)<sup>(1)</sup> (continued)

Symbol	Parameter	Test conditions	Min.	Typ.	Max.	Unit
SVR	Supply voltage rejection	$\Delta V_{CC} = 1.2\text{ V to }5\text{ V}$ $-40\text{ °C} < T_{amb} < +125\text{ °C}$	65	80		dB
$T_{PLH}$	Propagation delay (low to high)	$f = 1\text{ kHz}$ , $C_L = 30\text{ pF}$ , $R_L = 1\text{ M}\Omega$ Overdrive = 10 mV $-40\text{ °C} < T_{amb} < +125\text{ °C}$		8.3	13 22	$\mu\text{s}$
		Overdrive = 100 mV $-40\text{ °C} < T_{amb} < +125\text{ °C}$		2.5	3.4 4.1	
$T_{PHL}$	Propagation delay (high to low)	$f = 1\text{ kHz}$ , $C_L = 30\text{ pF}$ , $R_L = 1\text{ M}\Omega$ Overdrive = 10 mV $-40\text{ °C} < T_{amb} < +125\text{ °C}$		9.0	16 19	$\mu\text{s}$
		Overdrive = 100 mV $-40\text{ °C} < T_{amb} < +125\text{ °C}$		2.6	3.5 4.2	
$T_R$	Rise time (10% to 90%)	$C_L = 30\text{ pF}$ , $R_L = 1\text{ M}\Omega$		160		ns
$T_F$	Fall time (90% to 10%)	$C_L = 30\text{ pF}$ , $R_L = 1\text{ M}\Omega$		150		ns
$T_{ON}$	Power-up time			1.1	1.7	ms

1. All values over the temperature range are guaranteed through correlation and simulation. No production test is performed at the temperature range limits.
2. The offset is defined as the average value of positive and negative trip points (input voltage differences requested to change the output state in each direction).
3. The hysteresis is a built-in feature of the TS882 device. It is defined as the voltage difference between the trip points.
4. Maximum values include unavoidable inaccuracies of the industrial tests.



Figure 3. Current consumption per operator vs. supply voltage - output low

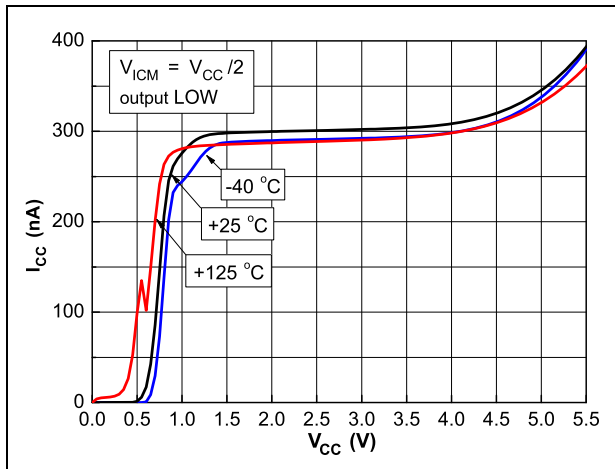

Figure 4. Current consumption per operator vs. supply voltage - output high

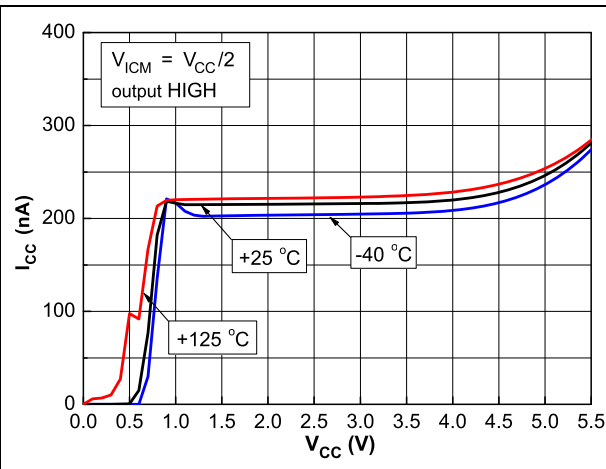

Figure 5. Current consumption per operator vs. input common mode voltage at V<sub>CC</sub> = 1.2 V

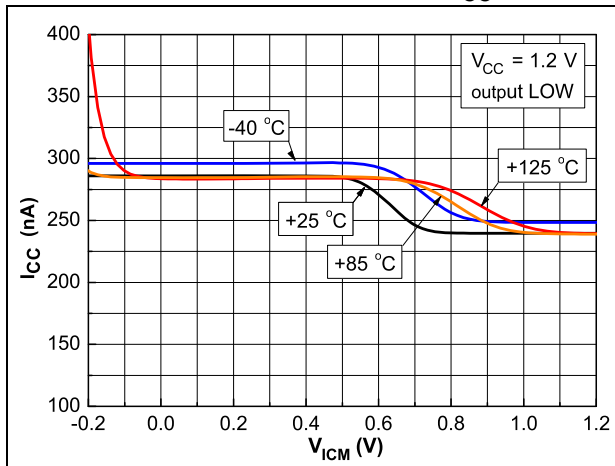

Figure 6. Current consumption per operator vs. input common mode voltage at V<sub>CC</sub> = 5 V

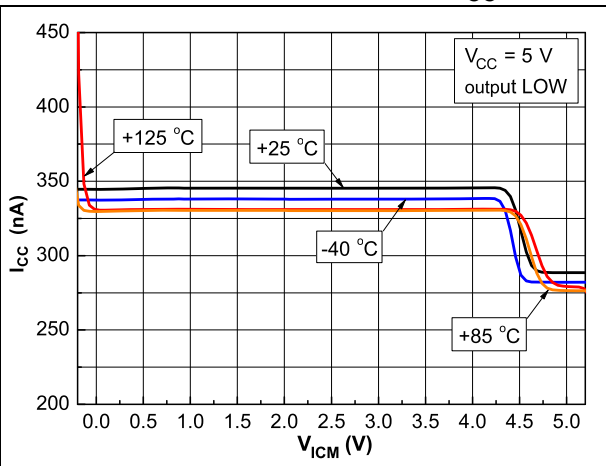

Figure 7. Current consumption per operator vs. temperature

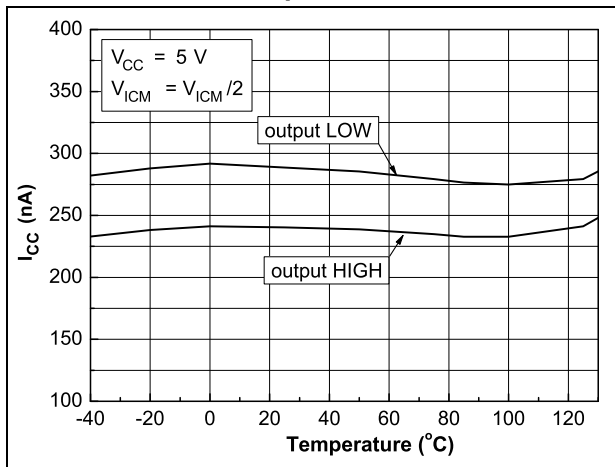

Figure 8. Current consumption per operator vs. toggle frequency

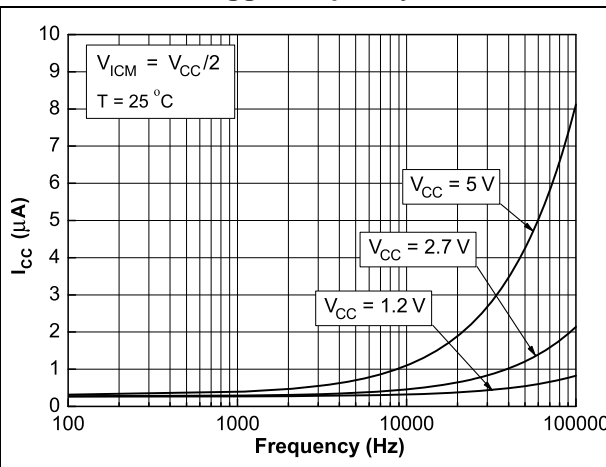

Figure 9. Input offset voltage vs. input common mode voltage at  $V_{CC} = 1.2\text{ V}$

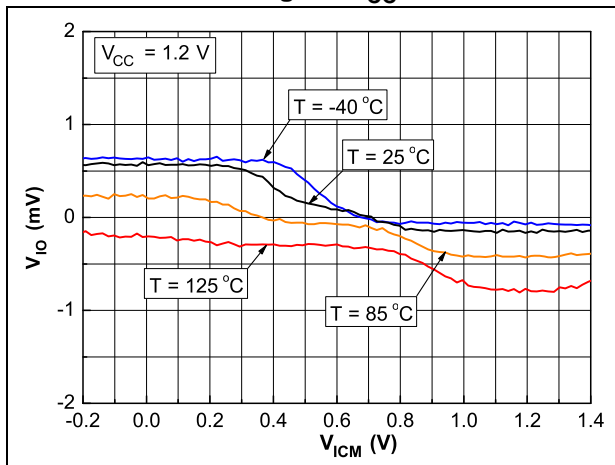

Figure 10. Input hysteresis voltage vs. input common mode voltage at  $V_{CC} = 1.2\text{ V}$

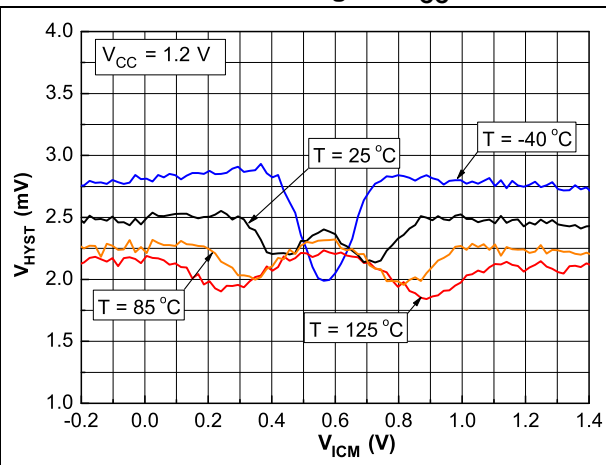

Figure 11. Input offset voltage vs. input common mode voltage at  $V_{CC} = 5\text{ V}$

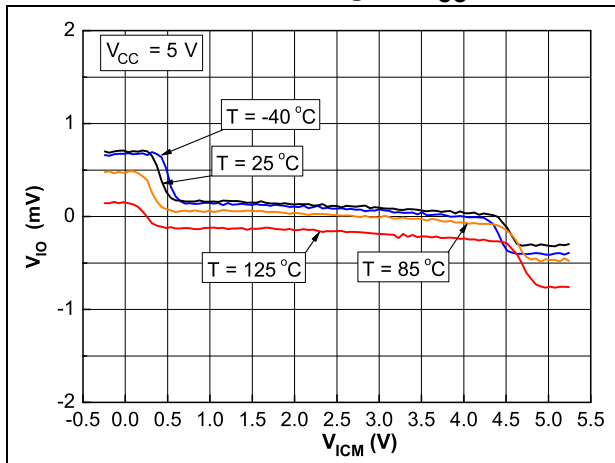

Figure 12. Input hysteresis voltage vs. input common mode voltage at  $V_{CC} = 5\text{ V}$

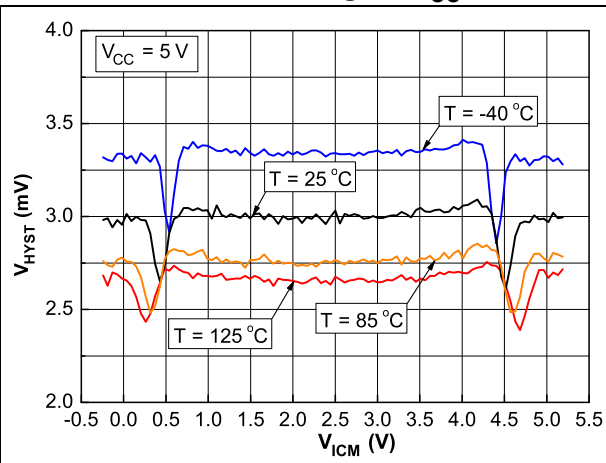

Figure 13. Input offset voltage vs. temperature

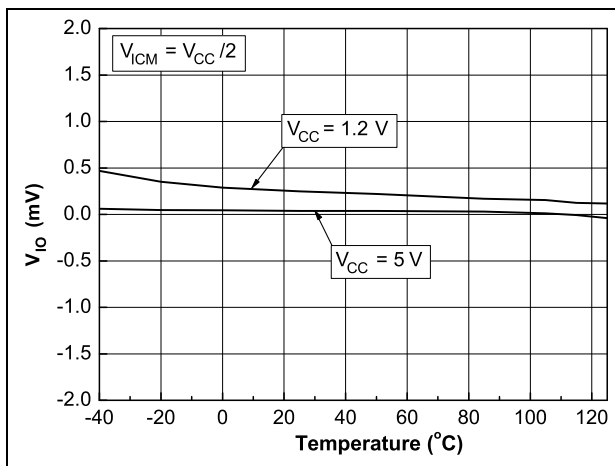

Figure 14. Input hysteresis voltage vs. temperature

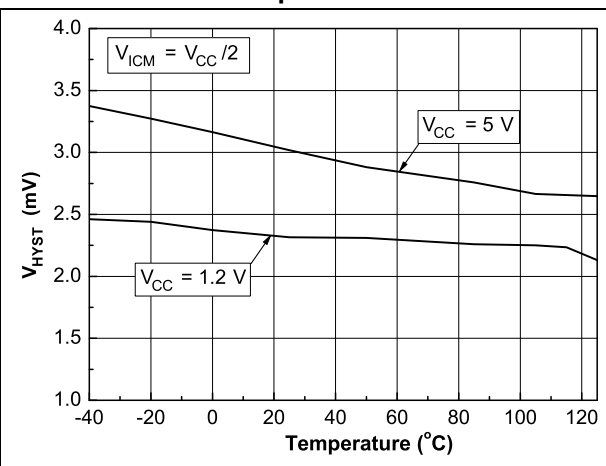

Figure 15. Output voltage drop vs. sink current at  $V_{CC} = 1.2\text{ V}$

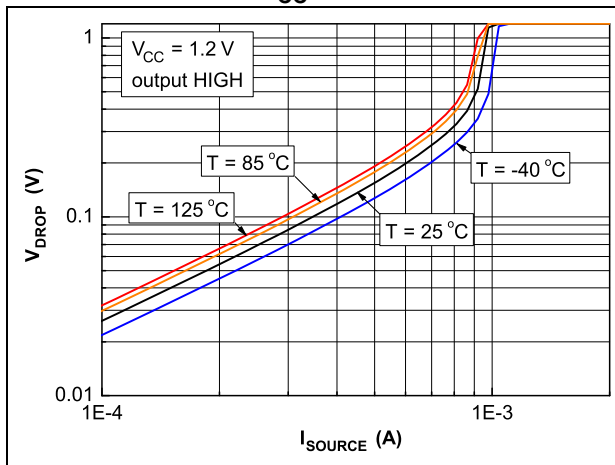

Figure 16. Output voltage drop vs. source current at  $V_{CC} = 1.2\text{ V}$

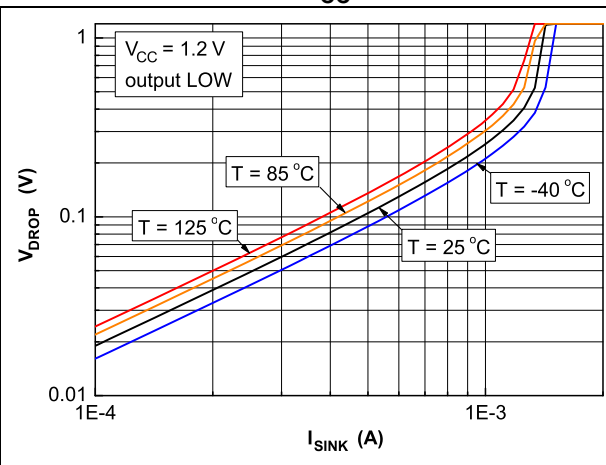

Figure 17. Output voltage drop vs. sink current at  $V_{CC} = 2.7\text{ V}$

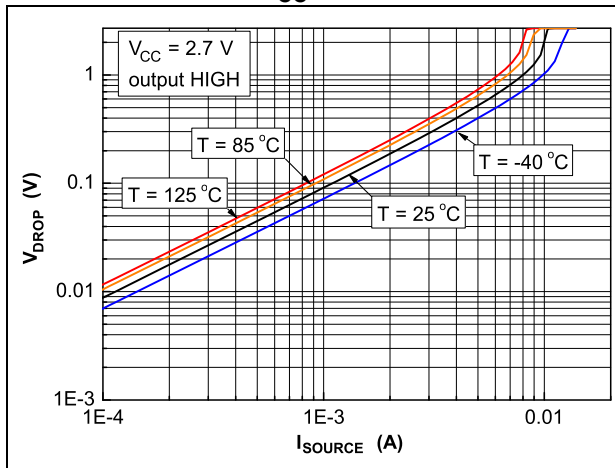

Figure 18. Output voltage drop vs. source current at  $V_{CC} = 2.7\text{ V}$

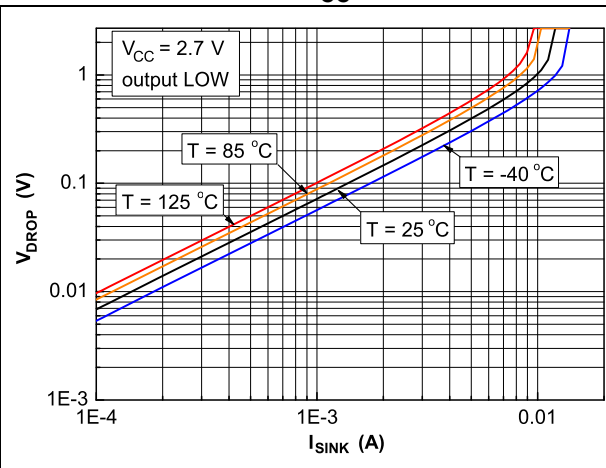

Figure 19. Output voltage drop vs. sink current at  $V_{CC} = 5\text{ V}$

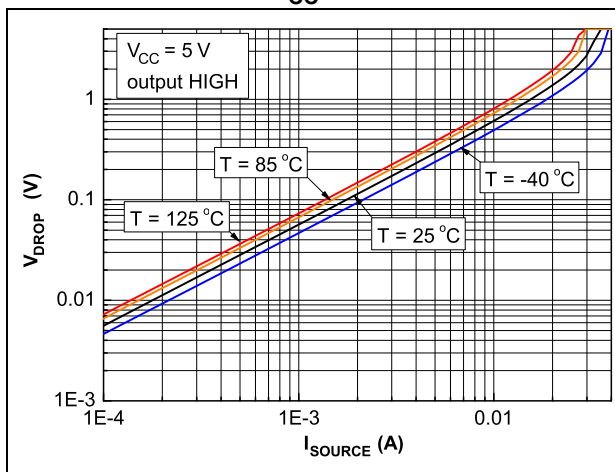

Figure 20. Output voltage drop vs. source current at  $V_{CC} = 5\text{ V}$

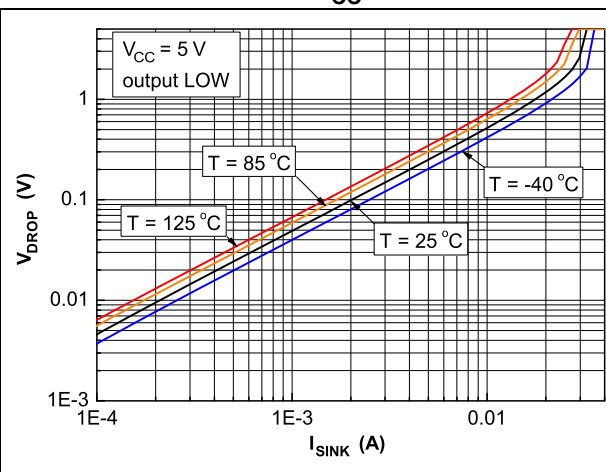

Figure 21. Propagation delay  $T_{PLH}$  vs. input common mode voltage at  $V_{CC} = 1.2 V$

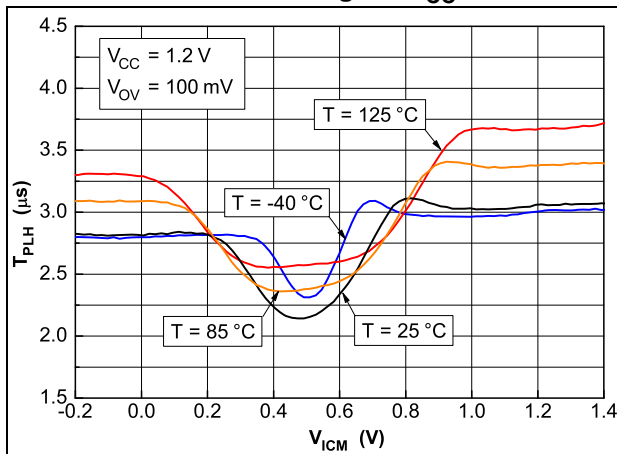

Figure 22. Propagation delay  $T_{PHL}$  vs. input common mode voltage at  $V_{CC} = 1.2 V$

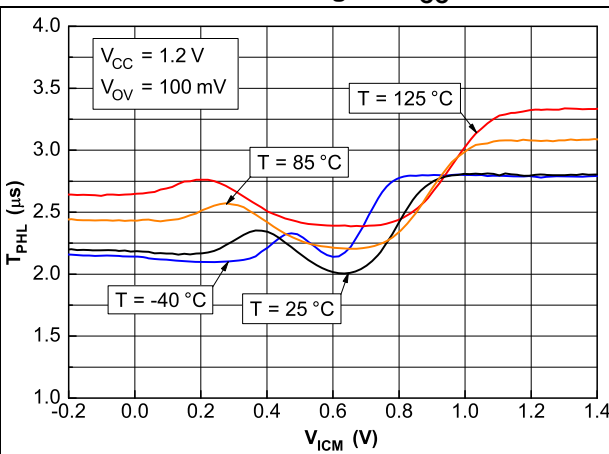

Figure 23. Propagation delay  $T_{PLH}$  vs. input common mode voltage at  $V_{CC} = 5 V$

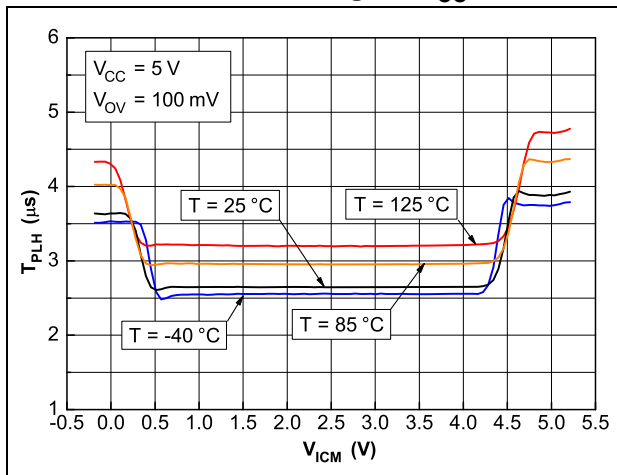

Figure 24. Propagation delay  $T_{PHL}$  vs. input common mode voltage at  $V_{CC} = 5 V$

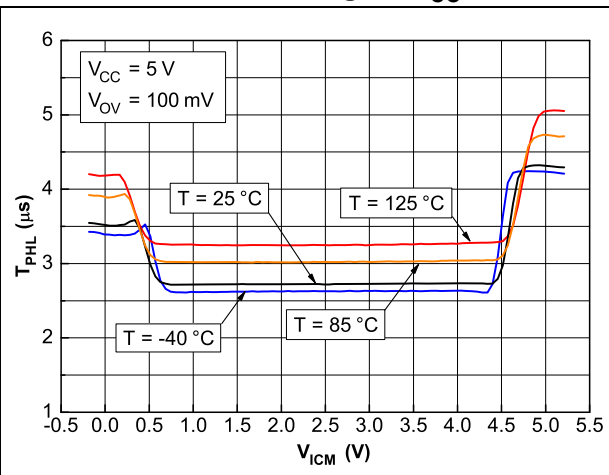

Figure 25. Propagation delay  $T_{PLH}$  vs. input signal overdrive at  $V_{CC} = 1.2 V$

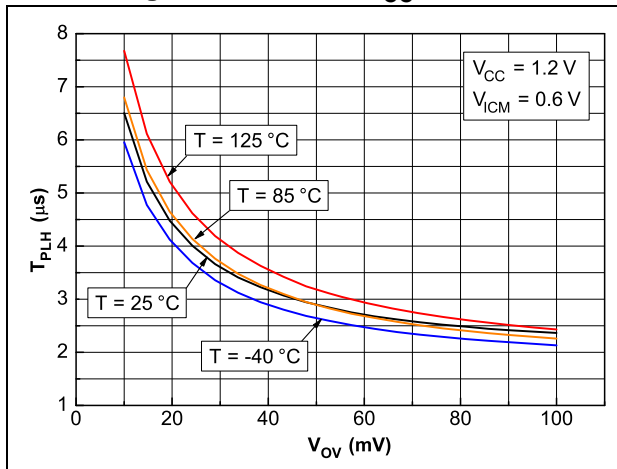

Figure 26. Propagation delay  $T_{PHL}$  vs. input signal overdrive at  $V_{CC} = 1.2 V$

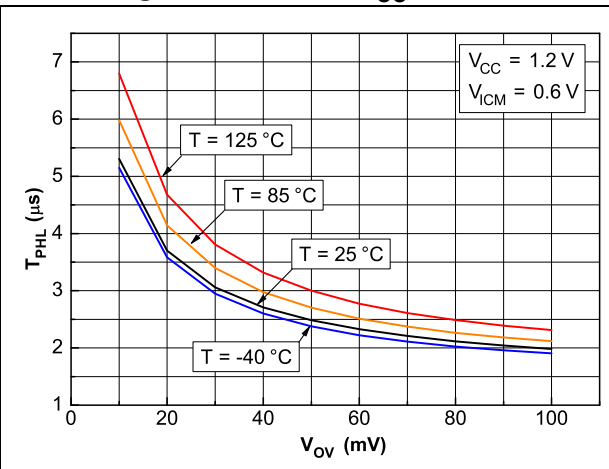

Figure 27. Propagation delay  $T_{PLH}$  vs. input signal overdrive at  $V_{CC} = 5\text{ V}$

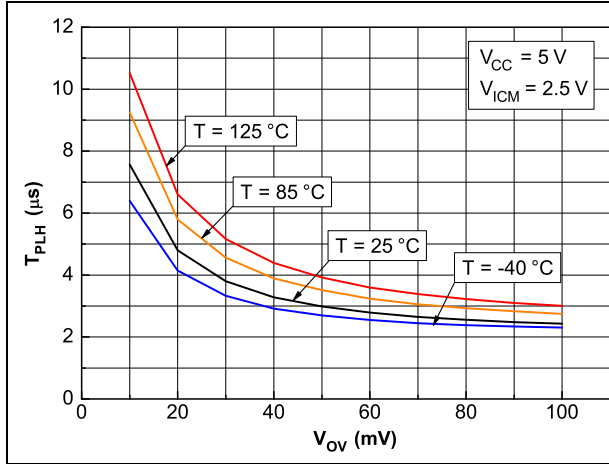

Figure 28. Propagation delay  $T_{PHL}$  vs. input signal overdrive at  $V_{CC} = 5\text{ V}$

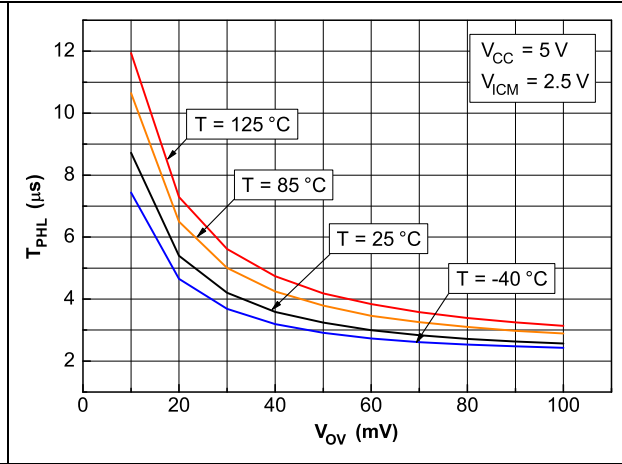

Figure 29. Propagation delay  $T_{PLH}$  vs. supply voltage for signal overdrive 10 mV

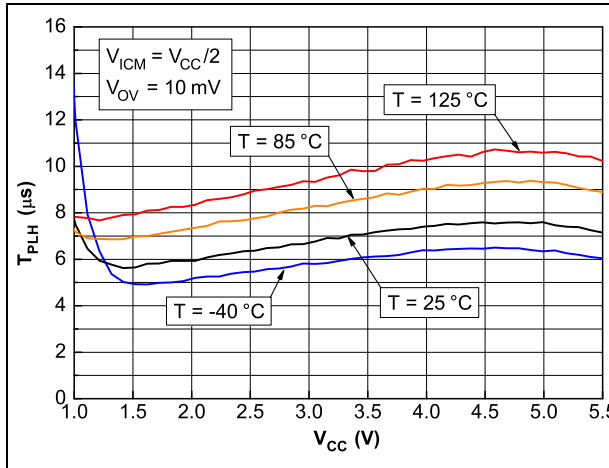

Figure 30. Propagation delay  $T_{PHL}$  vs. supply voltage for signal overdrive 10 mV

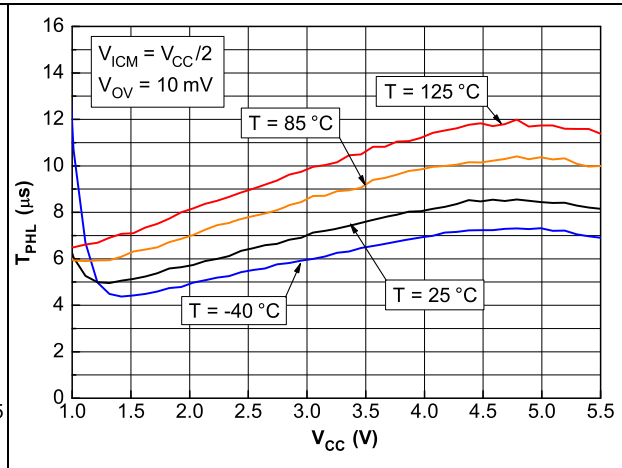

Figure 31. Propagation delay  $T_{PLH}$  vs. supply voltage for signal overdrive 100 mV

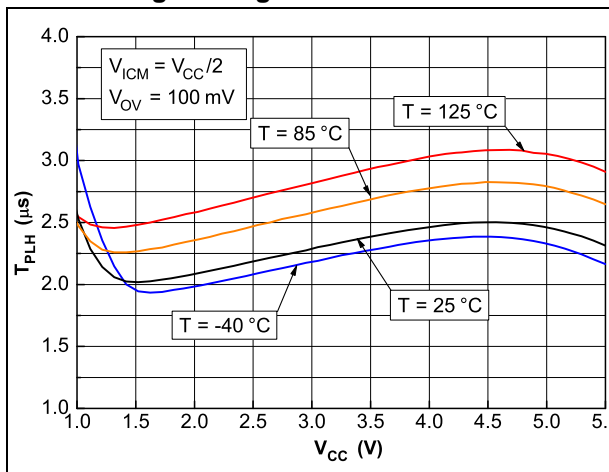

Figure 32. Propagation delay  $T_{PHL}$  vs. supply voltage for signal overdrive 100 mV

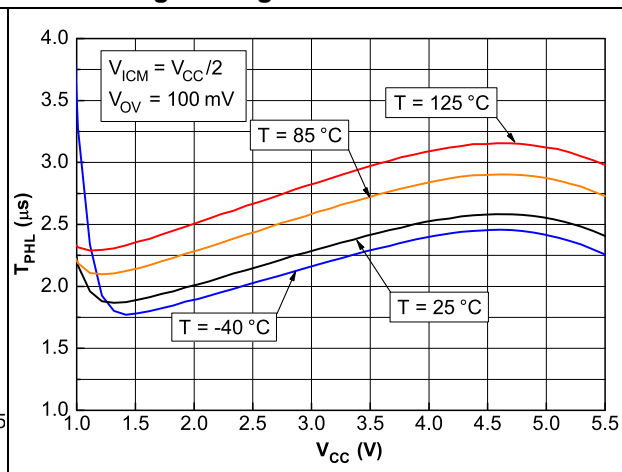

Figure 33. Propagation delay vs. temperature for signal overdrive 10 mV

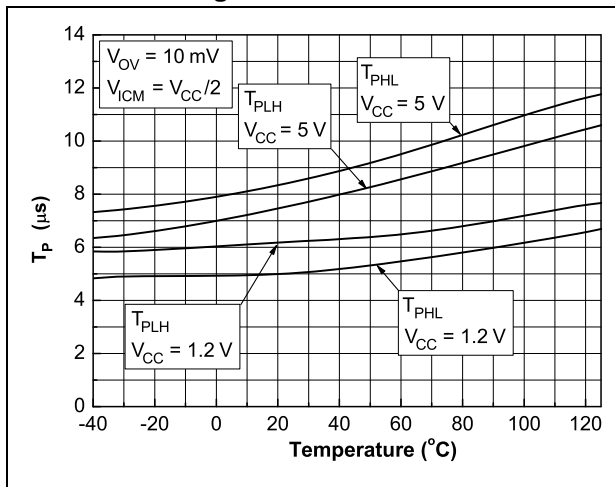
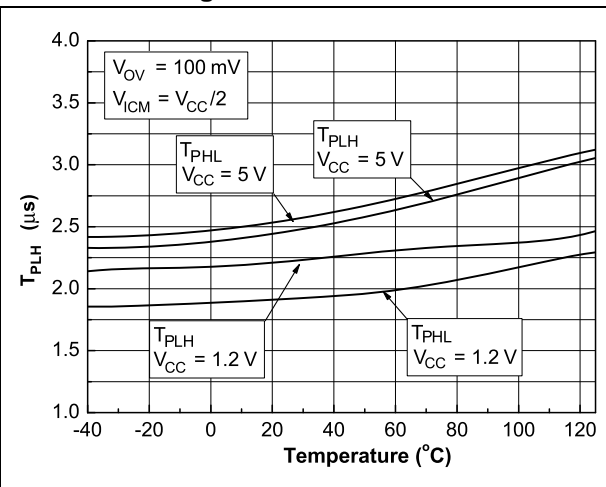

Figure 34. Propagation delay vs. temperature for signal overdrive 100 mV



## 4 Package information

In order to meet environmental requirements, ST offers these devices in different grades of ECOPACK<sup>®</sup> packages, depending on their level of environmental compliance. ECOPACK specifications, grade definitions and product status are available at: [www.st.com](http://www.st.com). ECOPACK is an ST trademark.

### 4.1 DFN8 2 x 2 mm package information

Figure 35. DFN8 2 x 2 mm package outline

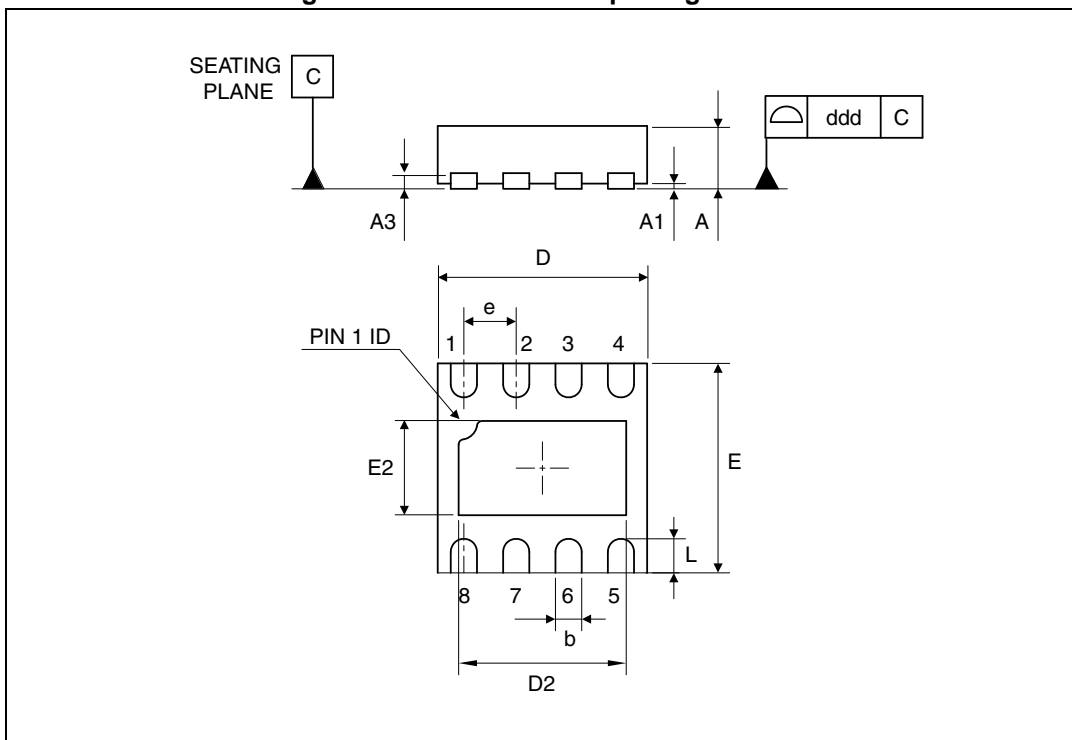
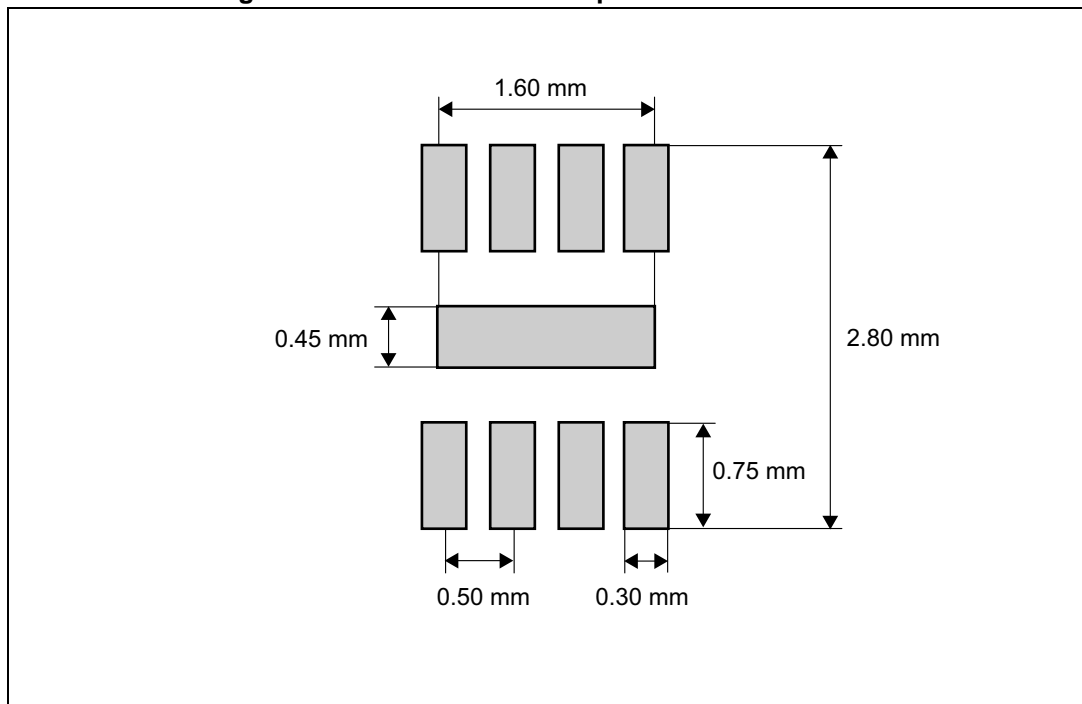

Table 7. DFN8 2 x 2 mm package mechanical data (pitch 0.5 mm)

Symbol	Dimensions					
	Millimeters			Inches		
	Min.	Typ.	Max.	Min.	Typ.	Max.
A	0.51	0.55	0.60	0.020	0.022	0.024
A1			0.05			0.002
A3		0.15			0.006	
b	0.18	0.25	0.30	0.007	0.010	0.012
D	1.85	2.00	2.15	0.073	0.079	0.085
D2	1.45	1.60	1.70	0.057	0.063	0.067
E	1.85	2.00	2.15	0.073	0.079	0.085
E2	0.75	0.90	1.00	0.030	0.035	0.039
e		0.50			0.020	
L			0.50			0.020
ddd			0.08			0.003



Figure 36. DFN8 2 x 2 mm footprint recommendation



## 4.2 MiniSO8 package information

Figure 37. MiniSO8 package outline

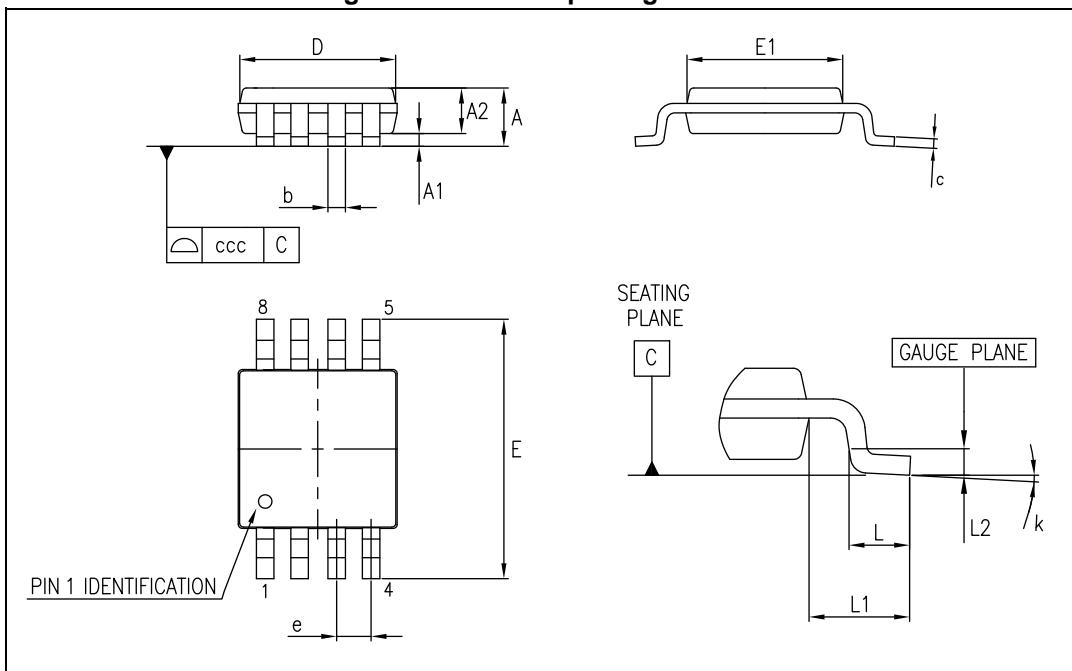

Table 8. MiniSO8 package mechanical data

Symbol	Dimensions					
	Millimeters			Inches		
	Min.	Typ.	Max.	Min.	Typ.	Max.
A			1.10			0.043
A1	0		0.15	0		0.006
A2	0.75	0.85	0.95	0.030	0.033	0.037
b	0.22		0.40	0.009		0.016
c	0.08		0.23	0.003		0.009
D	2.80	3.00	3.20	0.11	0.118	0.126
E	4.65	4.90	5.15	0.183	0.193	0.203
E1	2.80	3.00	3.10	0.11	0.118	0.122
e		0.65			0.026	
L	0.40	0.60	0.80	0.016	0.024	0.031
L1		0.95			0.037	
L2		0.25			0.010	
k	0°		8°	0°		8°
ccc			0.10			0.004

### 4.3 SO14 package information

Figure 38. SO14 package outline

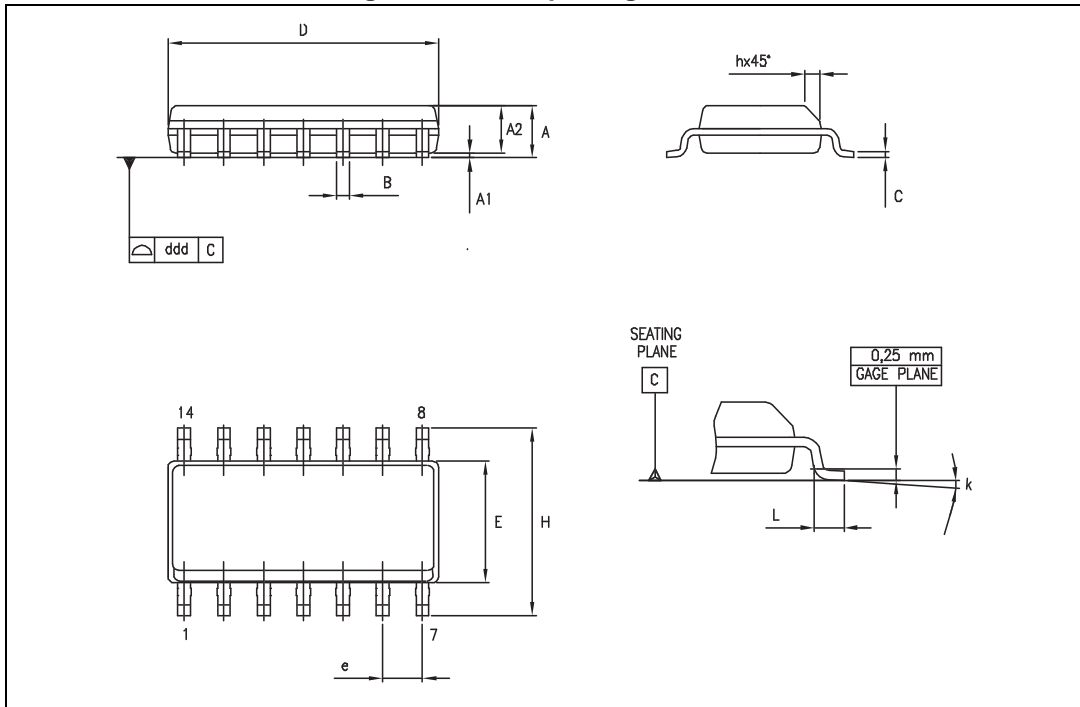

Table 9. SO14 package mechanical data

Dimensions <sup>(1)</sup>							
Symbol	Millimeters			Inches			Note
	Min.	Typ.	Max.	Min.	Typ.	Max.	
A	1.35		1.75	0.05		0.068	
A1	0.10		0.25	0.004		0.009	
A2	1.10		1.65	0.04		0.06	
B	0.33		0.51	0.01		0.02	
C	0.19		0.25	0.007		0.009	
D	8.55		8.75	0.33		0.34	(2)
E	3.80		4.0	0.15		0.15	
e		1.27			0.05		
H	5.80		6.20	0.22		0.24	
L	0.40		1.27	0.015		0.05	
k	0°		8°	0°		8°	
ddd			0.10			0.004	

1. Drawing dimensions include "Single" and "Matrix" versions.
2. Dimension "D" does not include mold flash, protrusions or gate burrs. Mold flash, protrusions or gate burrs shall not exceed 0.15 mm per side.

### 4.4 QFN16 3 x 3 package information

Figure 39. QFN16 3 x 3 mm (pitch 0.5 mm) package outline

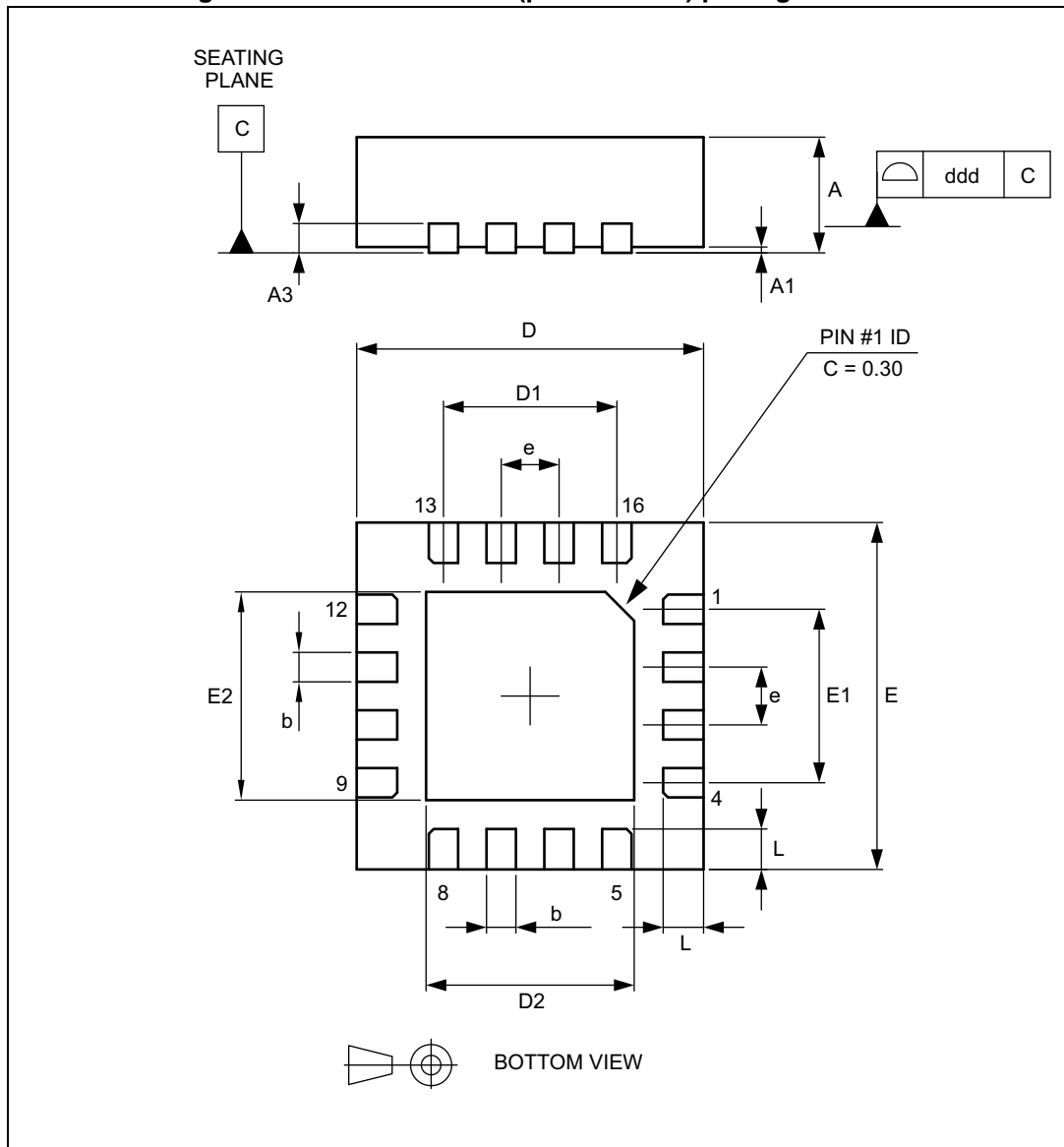
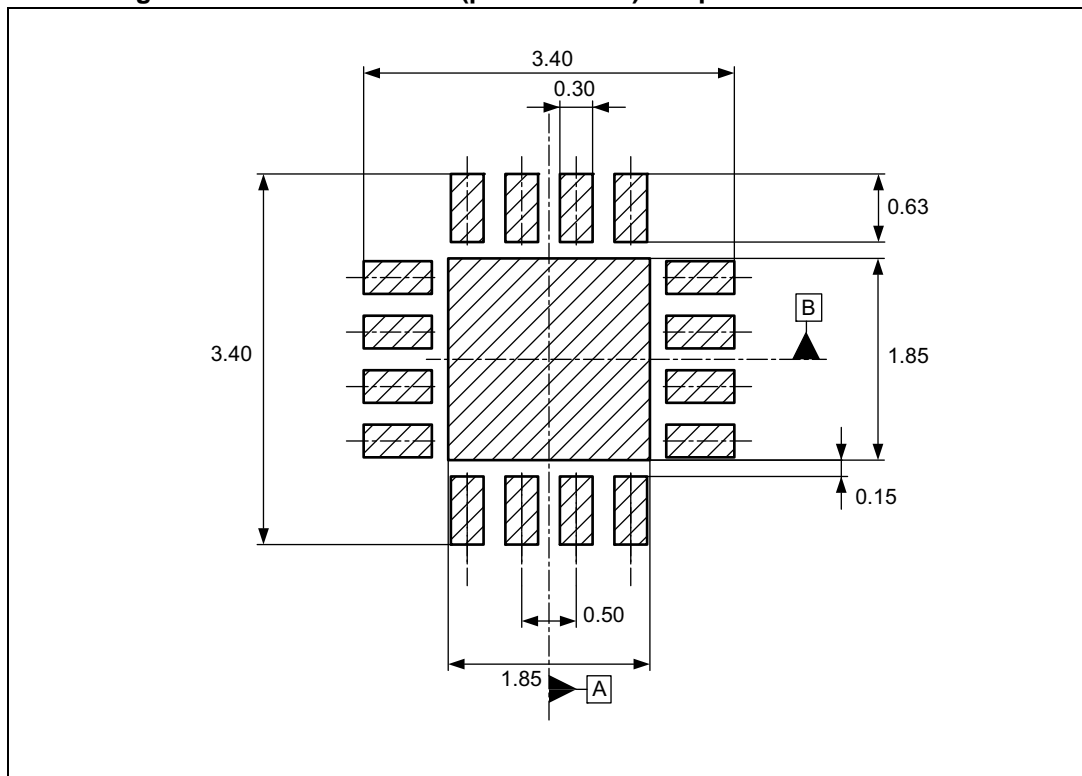

Table 10. QFN16 3 x 3 mm (pitch 0.5 mm) package mechanical data

Symbol	Dimensions					
	Millimeters			Inches		
	Min.	Typ.	Max.	Min.	Typ.	Max.
A	0.80	0.90	1.00	0.031	0.035	0.039
A1		0.02	0.05		0.001	0.002
A3		0.20			0.008	
b	0.18	0.25	0.30	0.007	0.010	0.012
D	2.85	3.00	3.15	0.112	0.118	0.124
D1		1.50			0.059	
D2	See exposed pad variation			See exposed pad variation		
E	2.85	3.00	3.15	0.112	0.118	0.124
E1		1.50			0.059	
E2	See exposed pad variation			See exposed pad variation		
e	0.45	0.50	0.55	0.018	0.020	0.022
L	0.30	0.40	0.50	0.012	0.016	0.020
ddd			0.08			0.003

Figure 40. QFN16 3 x 3 mm (pitch 0.5 mm) footprint recommendation



### 4.5 TSSOP14 package information

Figure 41. TSSOP14 package outline

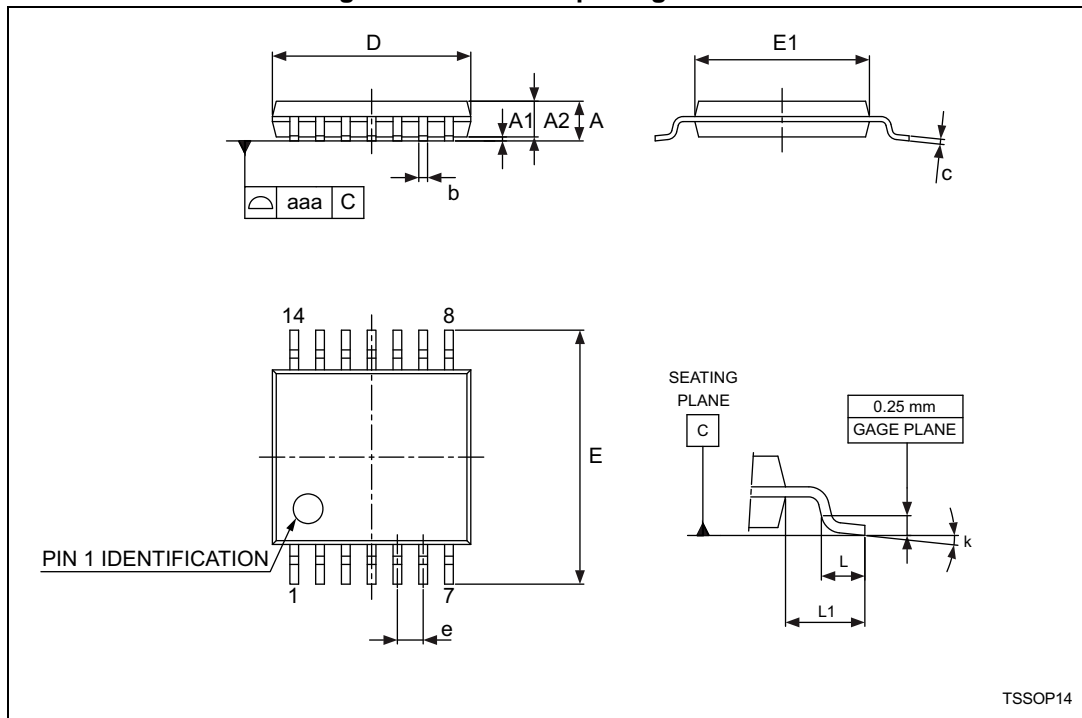

Table 11. TSSOP14 package mechanical data

Symbol	Dimensions					
	Millimeters			Inches		
	Min.	Typ.	Max.	Min.	Typ.	Max.
A			1.20			0.047
A1	0.05		0.15	0.002	0.004	0.006
A2	0.80	1.00	1.05	0.031	0.039	0.041
b	0.19		0.30	0.007		0.012
c	0.09		0.20	0.004		0.0089
D	4.90	5.00	5.10	0.193	0.197	0.201
E	6.20	6.40	6.60	0.244	0.252	0.260
E1	4.30	4.40	4.50	0.169	0.173	0.176
e		0.65			0.0256	
L	0.45	0.60	0.75	0.018	0.024	0.030
L1		1.00			0.039	
k	0°		8°	0°		8°
aaa			0.10			0.004

## 5 Revision history

**Table 12. Document revision history**

Date	Revision	Changes
18-Jan-2013	1	Initial release.
02-May-2013	2	<p>Added TS884 device to header, Description, and Table 1: Device summary.</p> <p>Updated title (added “quad” comparator).</p> <p>Updated Features and Table 2 (ESD tolerance: “6 kV” HBM replaced by “8 kV” HBM).</p> <p>Updated Description in accordance with added TS884 device.</p> <p>Added SO14, TSSOP14 and QFN16 3 x 3 mm package to Features, figure on page 1, Section 4: Package information. and Table 1: Device summary.</p> <p>Moved Figure 1: Pin connections TS882 (top view) to page 3.</p> <p>Added Figure 2: Pin connections TS884 (top view).</p> <p>Updated Table 2: Absolute maximum ratings (added TS884 device RTHJA values).</p> <p>Minor corrections throughout document.</p>
14-Jul-2014	3	Updated Table 1: Device summary on page 1.
06-Jul-2017	4	Added order code TS882IYST in <a href="#">Table 1: Device summary</a> and “Automotive” in <a href="#">Applications</a> .



**IMPORTANT NOTICE – PLEASE READ CAREFULLY**

STMicroelectronics NV and its subsidiaries ("ST") reserve the right to make changes, corrections, enhancements, modifications, and improvements to ST products and/or to this document at any time without notice. Purchasers should obtain the latest relevant information on ST products before placing orders. ST products are sold pursuant to ST's terms and conditions of sale in place at the time of order acknowledgement.

Purchasers are solely responsible for the choice, selection, and use of ST products and ST assumes no liability for application assistance or the design of Purchasers' products.

No license, express or implied, to any intellectual property right is granted by ST herein.

Resale of ST products with provisions different from the information set forth herein shall void any warranty granted by ST for such product.

ST and the ST logo are trademarks of ST. All other product or service names are the property of their respective owners.

Information in this document supersedes and replaces information previously supplied in any prior versions of this document.

© 2017 STMicroelectronics – All rights reserved



## X-ON Electronics

Largest Supplier of Electrical and Electronic Components

*Click to view similar products for [Analog Comparators](#) category:*

*Click to view products by [STMicroelectronics](#) manufacturer:*

Other Similar products are found below :

[SC2903VDR2G](#) [LM2901SNG](#) [LM339SNG](#) [55122](#) [5962-8757203IA](#) [NTE911](#) [5962-8751601DA](#) [LM339EDR2G](#) [NTE922](#) [SC2901DR2G](#)  
[LM2903M/TR](#) [LM2903F-E2](#) [MCP6544-EP](#) [LM2901EDR2G](#) [TS391SN2T1G](#) [LM111JG](#) [LM239APT](#) [HMC675LC3CTR](#) [5962-8765801PA](#)  
[MAX9024AUD+](#) [LT6700HVIS6-2#TRMPBF](#) [5962-8765902CA](#) [ADCMP394ARZ-RL7](#) [LM339AMX](#) [LTC1440IMS8#PBF](#) [AZV331KSTR-](#)  
[G1](#) [LTC1841IS8#PBF](#) [LTC1440CN8#PBF](#) [LTC1542CS8#PBF](#) [LTC1445CS#PBF](#) [TL331VSN4T3G](#) [LT6700IDCB-1#TRMPBF](#)  
[LTC1042CN8#PBF](#) [LTC1540CMS8#PBF](#) [LT6703CDC-2#TRMPBF](#) [ADCMP607BCPZ-R7](#) [LT1720CDD#PBF](#) [LTC1040CN#PBF](#)  
[LT6700MPDCB-1#TRMPBF](#) [LT6700IDCB-3#TRMPBF](#) [LTC1440IS8#PBF](#) [S-89431ACNC-HBVTFG](#) [CMP402GSZ-REEL](#) [NTE1718](#)  
[NTE943](#) [NTE943M](#) [NTE943SM](#) [TA75S393F,LF\(T](#) [ALD2301APAL](#) [ALD2302APAL](#)