

Low power, 1.7 MHz, rail-to-rail output, 36 V operational amplifier

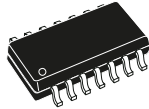

TSSOP14



SO14



MiniSO8

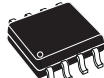

SO8



SOT23-5

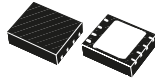

DFN8 (3 x 3 mm)

Features

- Low offset voltage: 1 mV max. @ 25 °C
- Low current consumption: 375 μ A max. / operator @ 36 V
- Wide supply voltage: 2.7 to 36 V
- Gain bandwidth product: 1.7 MHz
- Unity gain stable
- Rail-to-rail output
- Input common mode voltage includes ground
- High ESD tolerance: 4 kV HBM
- EMI hardened
- Extended temperature range: -40 to 125 °C
- Automotive qualification

Applications

- Industrial
- Power supplies
- Automotive

Maturity status link

[TSB621, TSB622, TSB624](#)

Related products

TSB611, TSB612	For lower power consumption
TSB571, TSB572, TSB514	For higher speed and rail-to-rail inputs
TSB711, TSB712	For a higher precision and speed

Description

The **TSB621, TSB622, TSB624** are general purpose operational amplifiers featuring an extended supply voltage operating range and rail-to-rail output. They also offer an excellent speed/power consumption ratio with 1.7 MHz gain bandwidth product while consuming less than 375 μ A per operator at 36 V supply voltage.

The **TSB621, TSB622, TSB624** operate over a wide temperature range from -40 °C to 125 °C making these devices ideal for industrial and automotive applications with the associated qualification.

Thanks to the small package size, the **TSB621, TSB622, TSB624** can be used in applications where space on the board is limited. It can thus reduce the overall cost of the PCB.

1 Pin connections

Figure 1. TSB621 pin connections (top view)

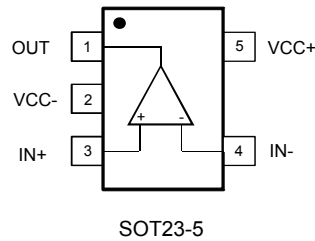
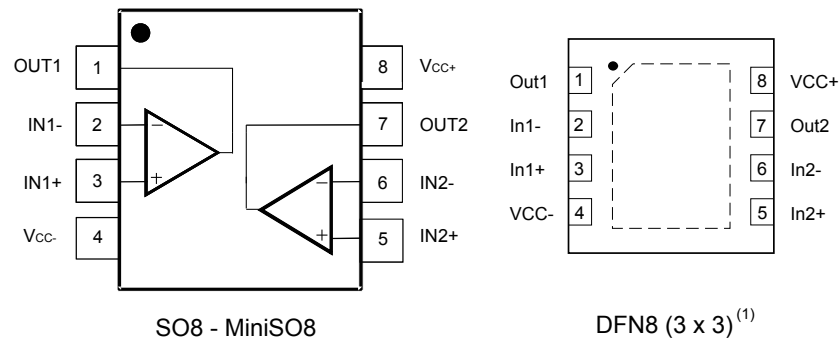

Table 1. TSB621 pin description

Pin n°	Pin name	Description
1	OUT1	Output
2	VCC -	Negative supply voltage
3	IN +	Positive input voltage
4	IN -	Negative input voltage
5	VCC	Positive supply voltage

Figure 2. TSB622 pin connections (top view)



(1) Exposed pad can be left floating or connected to ground.

Table 2. TSB622 pin description

Pin n°	Pin name	Description
1	OUT1	Output
2	IN1 -	Negative input voltage
3	IN1 +	Positive input voltage
4	VCC -	Negative supply voltage
5	IN2 +	Positive input voltage
6	IN2 -	Negative input voltage
7	OUT2	Output
8	VCC +	Positive supply voltage

Figure 3. TSB624 pin connections (top view)

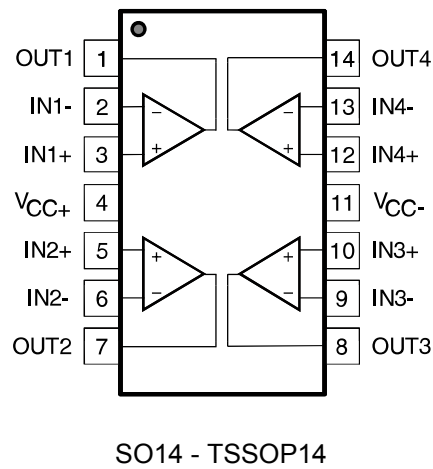

Table 3. TSB624 pin description

Pin n°	Pin name	Description
1	OUT1	Output
2	IN1 -	Negative input voltage
3	IN1 +	Positive input voltage
4	VCC +	Positive supply voltage
5	IN2 +	Positive input voltage
6	IN2 -	Negative input voltage
7	OUT2	Output
8	OUT3	Output
9	IN3 -	Negative input voltage
10	IN3 +	Positive input voltage
11	VCC -	Negative supply voltage
12	IN4 +	Positive input voltage
13	IN4 -	Negative input voltage
14	OUT4	Output

2 Absolute maximum ratings and operating conditions

Table 4. Absolute maximum ratings

Symbol	Parameter	Value	Unit
V_{CC}	Supply voltage ⁽¹⁾	40	V
V_{id}	Differential input voltage ⁽²⁾	$\pm V_{CC}$	V
V_{in}	Input voltage	$(V_{CC-}) - 0.2$ to $(V_{CC+}) + 0.2$	V
I_{in}	Input current ⁽³⁾	10	mA
T_{stg}	Storage temperature	-65 to 150	°C
T_j	Junction temperature	150	°C
R_{th-ja}	Thermal resistance junction to ambient ^{(4) (5)}		
	SO8	125	°C/W
	MiniSO8	190	
	DFN8 3x3 WF	40	
	SOT23-5	250	
	SO14	105	
TSSOP14	100		
ESD	Human Body Model (HBM TSB621, TSB622) ⁽⁶⁾	4000	V
	Human Body Model (HBM TSB624) ⁽⁶⁾	3000	
	Charged Device Model (CDM) ⁽⁷⁾	1500	

1. All voltage values, except differential voltage, are with respect to network ground terminal.
2. The differential voltage is the non-inverting input terminal with respect to the inverting input terminal.
3. Input current must be limited by a resistor in series with the inputs.
4. R_{th} are typical values.
5. Short-circuits can cause excessive heating and destructive dissipation.
6. According to JEDEC standard JESD22-A114F.
7. According to ANSI/ESD STM5.3.1.

Table 5. Operating conditions

Symbol	Parameter	Value	Unit
V_{CC}	Supply voltage	2.7 to 36	V
V_{icm}	Common mode voltage on input pins	$(V_{CC-}) - 0.1$ to $(V_{CC+}) - 1$	V
T	Operating free-air temperature range	-40 to 125	°C

3 Electrical characteristics

Table 6. Electrical characteristics $V_{CC+} = 2.7\text{ V}$, $V_{CC-} = 0\text{ V}$, $V_{icm} = V_{CC}/2$, $T = 25\text{ °C}$, $R_L = 10\text{ k}\Omega$ connected to $V_{CC}/2$ (unless otherwise specified)

Symbol	Parameter	Conditions	Min.	Typ.	Max.	Unit
DC performance						
V_{IO}	Input offset voltage	$T = 25\text{ °C}$	-1		1	mV
		$T_{min} < T < T_{max}$	-1.6		1.6	
$ \Delta V_{IO}/\Delta T $	Input offset voltage drift	$T_{min} < T < T_{max}$		2		$\mu\text{V}/\text{°C}$
I_{IB}	Input bias current	$T = 25\text{ °C}$		15	30	nA
		$T_{min} < T < T_{max}$			45	
I_{IO}	Input offset current	$T = 25\text{ °C}$		3	10	
		$T_{min} < T < T_{max}$			15	
CMR	Common mode rejection ratio: $20 \log (\Delta V_{icm}/\Delta V_{io})$	$V_{icm} = -0.1\text{ to }V_{CC} - 1\text{ V}$, $V_{OUT} = V_{CC}/2$	90	115		dB
		$T_{min} < T < T_{max}$	85			
A_{VD}	Large signal voltage gain	$V_{OUT} = 0.5\text{ V to } (V_{CC} - 0.5\text{ V})$	90	105		dB
		$T_{min} < T < T_{max}$	82			
V_{OH}	High-level output voltage, $V_{OH} = V_{CC} - V_{OUT}$	$T = 25\text{ °C}$		35	46	mV
		$T_{min} < T < T_{max}$			55	
V_{OL}	Low-level output voltage	$T = 25\text{ °C}$		50	60	
		$T_{min} < T < T_{max}$			75	
I_{OUT}	I_{sink}	$V_{OUT} = V_{CC}$	20	27		mA
		$T_{min} < T < T_{max}$	10			
	I_{source}	$V_{OUT} = 0\text{ V}$	20	28		
		$T_{min} < T < T_{max}$	8			
I_{CC}	Supply current (per channel)	No load, $V_{OUT} = V_{CC}/2$		280	330	μA
		$T_{min} < T < T_{max}$			400	
AC performance						
GBP	Gain bandwidth product	$R_L = 10\text{ k}\Omega$, $C_L = 100\text{ pF}$	1	1.45		MHz
		$T_{min} < T < T_{max}$	0.7			
Φ_m	Phase margin	$R_L = 10\text{ k}\Omega$, $C_L = 100\text{ pF}$		45		degrees
G_m	Gain margin			18		dB
SR	Slew rate	$T = 25\text{ °C}$	0.30	0.53		$\text{V}/\mu\text{s}$
		$T_{min} < T < T_{max}$	0.20			
E_N	Equivalent input noise voltage	$f = 1\text{ kHz}$		30		$\text{nV}/\sqrt{\text{Hz}}$
THD+N	Total harmonic distortion + noise	$f_{in} = 1\text{ kHz}$, Gain = 1, $R_L = 100\text{ k}\Omega$, $V_{icm} = (V_{CC} - 1\text{ V}) / 2$, BW = 22 kHz, $V_{OUT} = 1\text{ Vpp}$		0.005		%
C_S	Channel separation	$f = 1\text{ kHz}$		120		dB
t_{rec}	Overload recovery time			2		μs

Table 7. Electrical characteristics $V_{CC+} = 12\text{ V}$, $V_{CC-} = 0\text{ V}$, $V_{icm} = V_{CC}/2$, $T = 25\text{ }^{\circ}\text{C}$, $R_L = 10\text{ k}\Omega$ connected to $V_{CC}/2$ (unless otherwise specified)

Symbol	Parameter	Conditions	Min.	Typ.	Max.	Unit
DC performance						
V_{IO}	Input offset voltage	$T = 25\text{ }^{\circ}\text{C}$	-1		1	mV
		$T_{min} < T < T_{max}$	-1.6		1.6	
$ \Delta V_{IO}/\Delta T $	Input offset voltage drift	$T_{min} < T < T_{max}$		2		$\mu\text{V}/^{\circ}\text{C}$
I_{IB}	Input bias current	$T = 25\text{ }^{\circ}\text{C}$		15	30	nA
		$T_{min} < T < T_{max}$			45	
I_{IO}	Input offset current	$T = 25\text{ }^{\circ}\text{C}$		3	10	
		$T_{min} < T < T_{max}$			15	
CMR	Common mode rejection ratio: $20 \log (\Delta V_{icm}/\Delta V_{io})$	$V_{icm} = -0.1 \text{ to } V_{CC} - 1\text{ V}$, $V_{OUT} = V_{CC}/2$	100	130		dB
		$T_{min} < T < T_{max}$	95			
A_{VD}	Large signal voltage gain	$V_{OUT} = 0.5\text{ V to } (V_{CC} - 0.5\text{ V})$	98	115		dB
		$T_{min} < T < T_{max}$	90			
V_{OH}	High-level output voltage, $V_{OH} = V_{CC} - V_{OUT}$	$T = 25\text{ }^{\circ}\text{C}$		68	80	mV
		$T_{min} < T < T_{max}$			95	
V_{OL}	Low-level output voltage	$T = 25\text{ }^{\circ}\text{C}$		86	100	mV
		$T_{min} < T < T_{max}$			125	
I_{OUT}	I_{sink}	$V_{OUT} = V_{CC}$	25	35		mA
		$T_{min} < T < T_{max}$	10			
	I_{source}	$V_{OUT} = 0\text{ V}$	30	37		
		$T_{min} < T < T_{max}$	15			
I_{CC}	Supply current (per channel)	No load, $V_{OUT} = V_{CC}/2$		295	345	μA
		$T_{min} < T < T_{max}$			420	
AC performance						
GBP	Gain bandwidth product	$R_L = 10\text{ k}\Omega$, $C_L = 100\text{ pF}$	1.1	1.55		MHz
		$T_{min} < T < T_{max}$	0.8			
Φ_m	Phase margin	$R_L = 10\text{ k}\Omega$, $C_L = 100\text{ pF}$		45		degrees
G_m	Gain margin			18		dB
SR	Slew rate	$T = 25\text{ }^{\circ}\text{C}$	0.35	0.58		$\text{V}/\mu\text{s}$
		$T_{min} < T < T_{max}$	0.20			
E_N	Equivalent input noise voltage	$f = 1\text{ kHz}$		30		$\text{nV}/\sqrt{\text{Hz}}$
THD+N	Total harmonic distortion + noise	$f_{in} = 1\text{ kHz}$, Gain = 1, $R_L = 100\text{ k}\Omega$, $V_{icm} = (V_{CC} - 1\text{ V}) / 2$, BW = 22 kHz, $V_{OUT} = 1\text{ Vpp}$		0.005		%
C_S	Channel separation	$f = 1\text{ kHz}$		120		dB
t_{rec}	Overload recovery time			2		μs

Table 8. Electrical characteristics $V_{CC+} = 36\text{ V}$, $V_{CC-} = 0\text{ V}$, $V_{icm} = V_{CC}/2$, $T = 25\text{ }^{\circ}\text{C}$, $R_L = 10\text{ k}\Omega$ connected to $V_{CC}/2$ (unless otherwise specified)

Symbol	Parameter	Conditions	Min.	Typ.	Max.	Unit
DC performance						
V_{IO}	Input offset voltage	$T = 25\text{ }^{\circ}\text{C}$	-1		1	mV
		$T_{min} < T < T_{max}$	-1.6		1.6	
$ \Delta V_{IO}/\Delta T $	Input offset voltage drift	$T_{min} < T < T_{max}$		2		$\mu\text{V}/^{\circ}\text{C}$
I_{IB}	Input bias current	$T = 25\text{ }^{\circ}\text{C}$		15	30	nA
		$T_{min} < T < T_{max}$			45	
I_{IO}	Input offset current	$T = 25\text{ }^{\circ}\text{C}$		3	10	
		$T_{min} < T < T_{max}$			15	
CMR	Common mode rejection ratio: $20 \log (\Delta V_{icm}/\Delta V_{io})$	$V_{icm} = -0.1 \text{ to } V_{CC} - 1\text{ V}$, $V_{OUT} = V_{CC}/2$	105	135		dB
		$T_{min} < T < T_{max}$	100			
SVR	Supply voltage rejection ratio: $20 \log (\Delta V_{CC}/\Delta V_{io})$	$V_{CC} = 4.5 \text{ to } 36\text{ V}$, $V_{icm} = 0\text{ V}$	100	124		dB
		$T_{min} < T < T_{max}$	95			
A_{VD}	Large signal voltage gain	$V_{OUT} = 0.5\text{ V to } (V_{CC} - 0.5\text{ V})$	105	120		dB
		$T_{min} < T < T_{max}$	100			
V_{OH}	High-level output voltage, $V_{OH} = V_{CC} - V_{OUT}$	$T = 25\text{ }^{\circ}\text{C}$		110	140	mV
		$T_{min} < T < T_{max}$			180	
V_{OL}	Low-level output voltage	$T = 25\text{ }^{\circ}\text{C}$		125	150	
		$T_{min} < T < T_{max}$			195	
I_{OUT}	I_{sink}	$V_{OUT} = V_{CC}$	35	45		mA
		$T_{min} < T < T_{max}$	15			
	I_{source}	$V_{OUT} = 0\text{ V}$	35	45		
		$T_{min} < T < T_{max}$	25			
I_{CC}	Supply current (per channel)	No load, $V_{OUT} = V_{CC}/2$		310	375	μA
		$T_{min} < T < T_{max}$			420	
AC performance						
GBP	Gain bandwidth product	$R_L = 10\text{ k}\Omega$, $C_L = 100\text{ pF}$	1.2	1.7		MHz
		$T_{min} < T < T_{max}$	0.95			
Φ_m	Phase margin	$R_L = 10\text{ k}\Omega$, $C_L = 100\text{ pF}$		45		degrees
G_m	Gain margin			18		dB
SR	Slew rate	$T = 25\text{ }^{\circ}\text{C}$	0.35	0.60		$\text{V}/\mu\text{s}$
		$T_{min} < T < T_{max}$	0.25			
E_N	Equivalent input noise voltage	$f = 1\text{ kHz}$		25		$\text{nV}/\sqrt{\text{Hz}}$
THD+N	Total harmonic distortion + noise	$f_{in} = 1\text{ kHz}$, Gain = 1, $R_L = 100\text{ k}\Omega$, $V_{icm} = (V_{CC} - 1\text{ V}) / 2$, BW = 22 kHz, $V_{OUT} = 1\text{ Vpp}$		0.005		%
C_S	Channel separation	$f = 1\text{ kHz}$		120		dB
t_{rec}	Overload recovery time			2		μs

4 Typical performance characteristics

Figure 4. Supply current vs. supply voltage

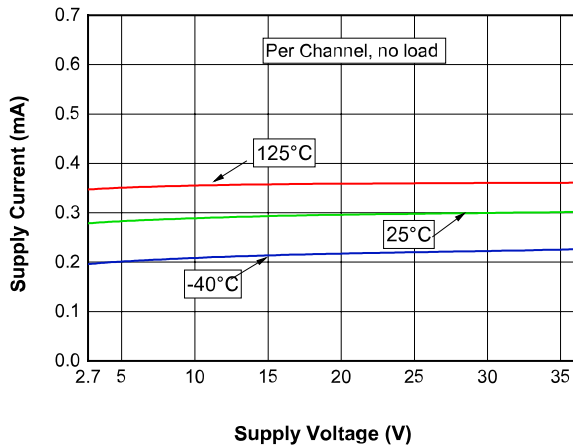

Figure 5. Input offset voltage distribution at $V_{CC} = 2.7\text{ V}$

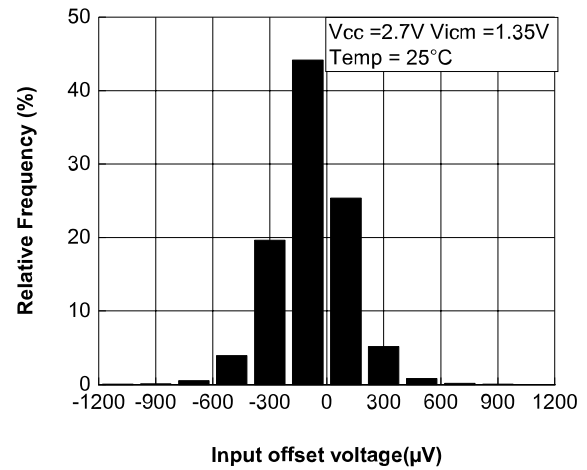

Figure 6. Input offset voltage distribution at $V_{CC} = 12\text{ V}$

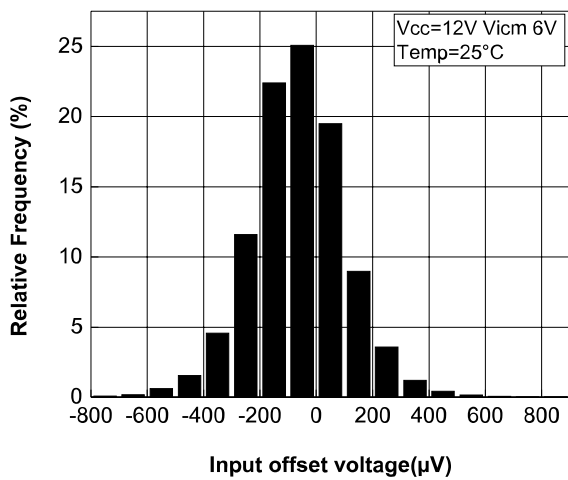

Figure 7. Input offset voltage distribution at $V_{CC} = 36\text{ V}$

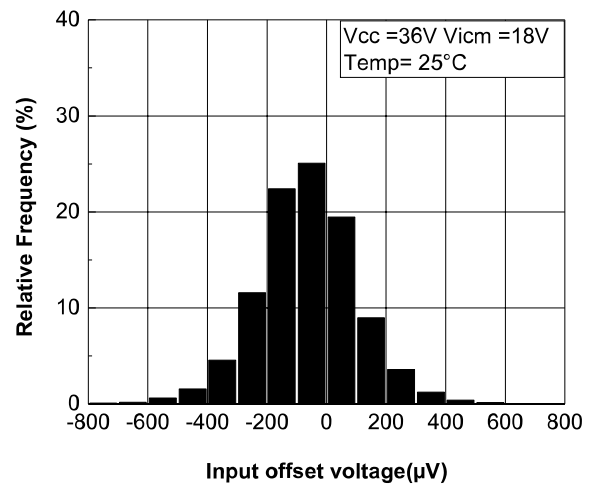

Figure 8. Input offset voltage vs. temperature at $V_{CC} = 36\text{ V}$

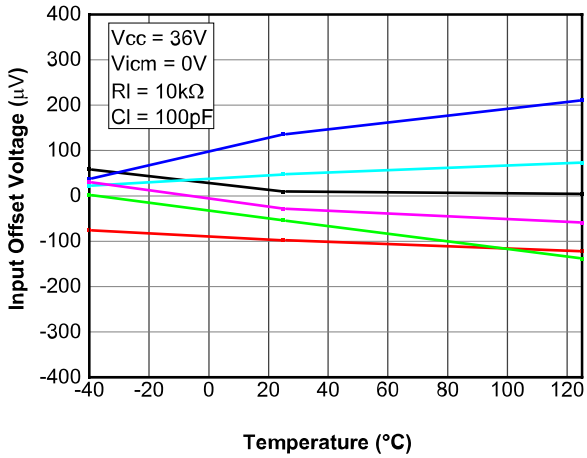

Figure 9. Input offset voltage temperature variation distribution at $V_{CC} = 36\text{ V}$

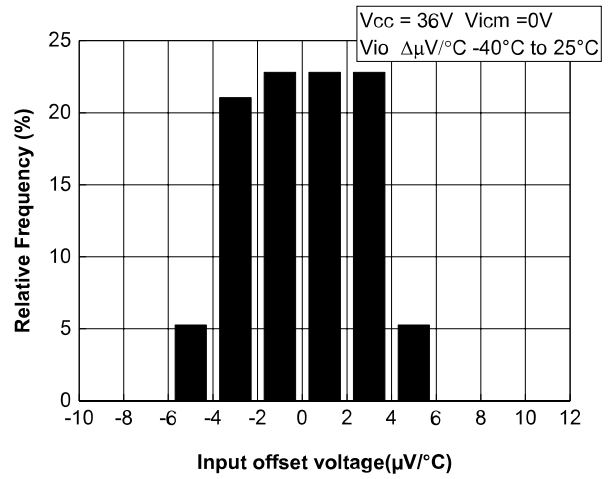

Figure 10. Input offset voltage temperature variation distribution at $V_{CC} = 36\text{ V}$

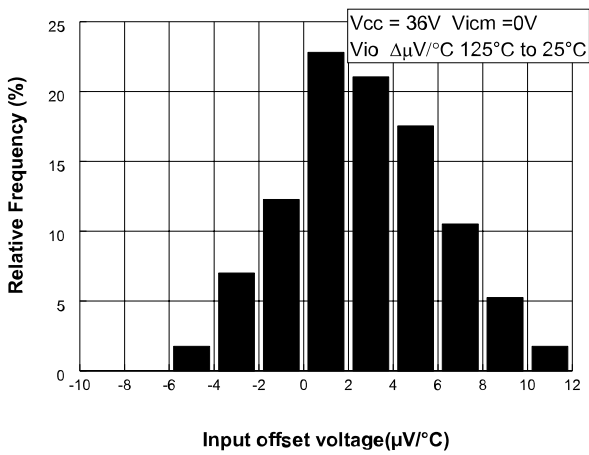

Figure 11. Input offset voltage vs. common-mode voltage at $V_{CC} = 36\text{ V}$

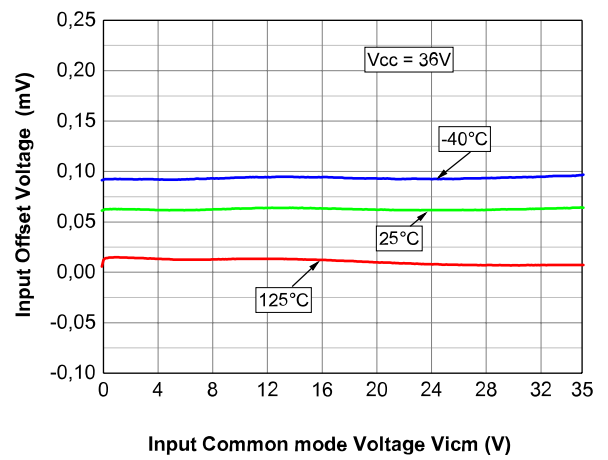

Figure 12. Common-mode reject. ratio CMR at $V_{CC} = 5\text{ V}$

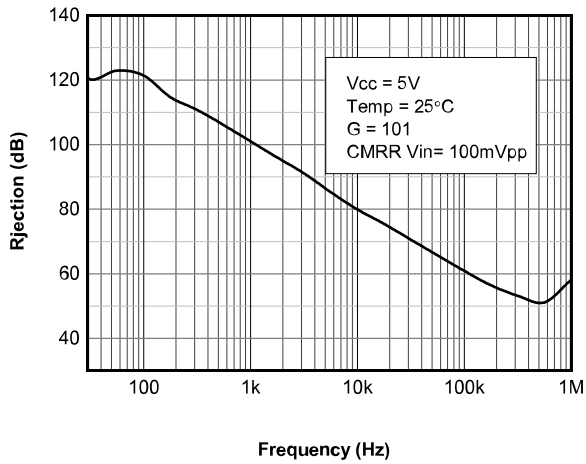

Figure 13. Supply voltage rejection ratio SVR at $V_{CC} = 5\text{ V}$

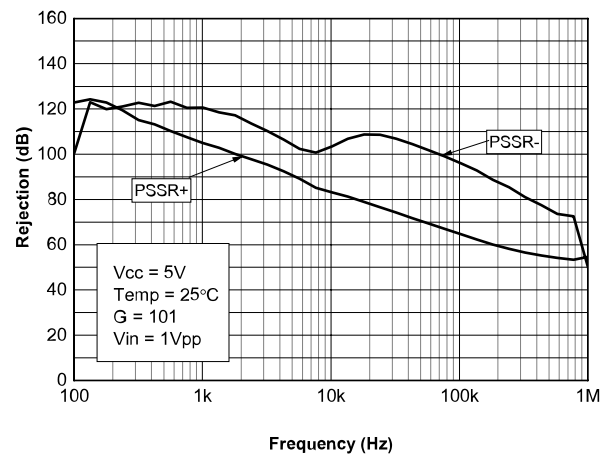

Figure 14. Input bias current vs. temperature

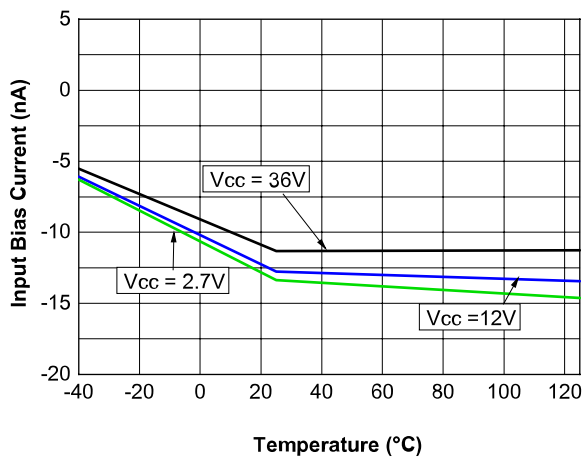

Figure 15. Bode diagram at $V_{CC} = 2.7\text{ V}$

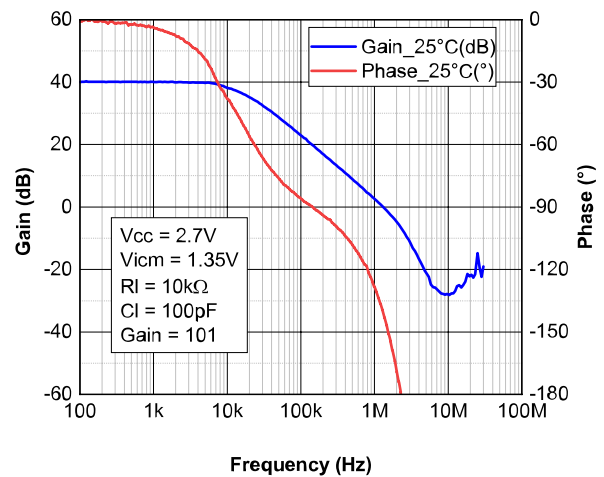

Figure 16. Bode diagram at $V_{CC} = 12\text{ V}$

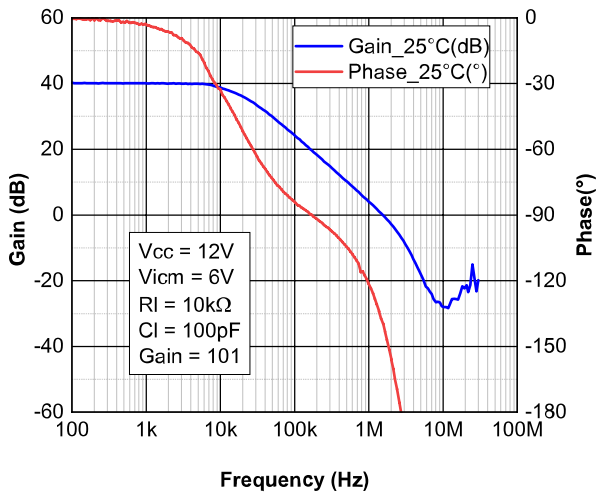

Figure 17. Bode diagram at $V_{CC} = 36\text{ V}$

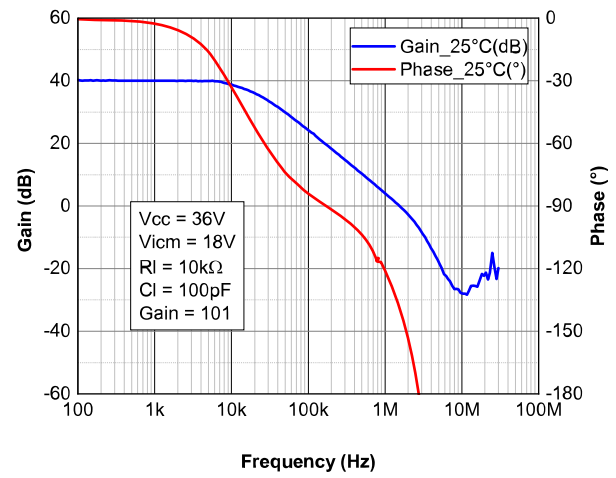

Figure 18. Overshoot vs. capacitive load at $V_{CC} = 36\text{ V}$

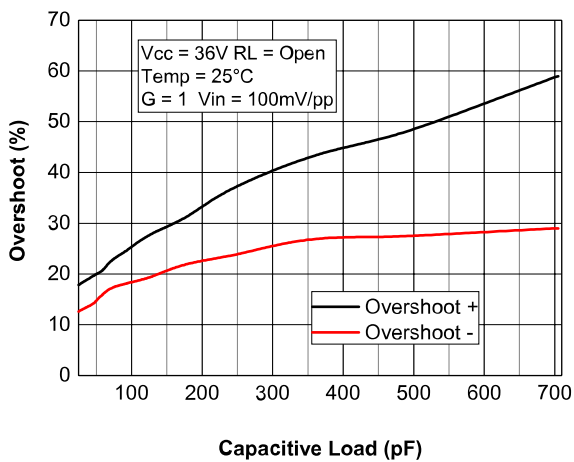

Figure 19. Phase margin vs. capacitive load at $V_{CC} = 2.7\text{ V}$

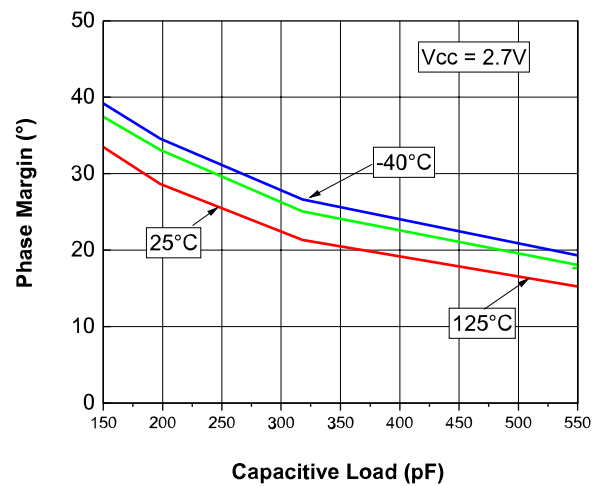

Figure 20. Phase margin vs. capacitive load at $V_{CC} = 12\text{ V}$

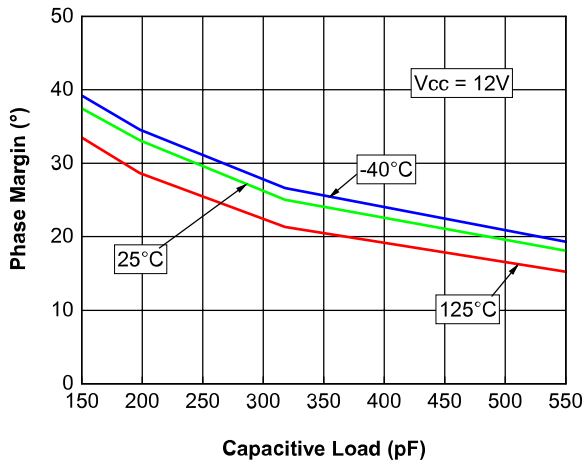

Figure 21. Phase margin vs. capacitive load at $V_{CC} = 36\text{ V}$

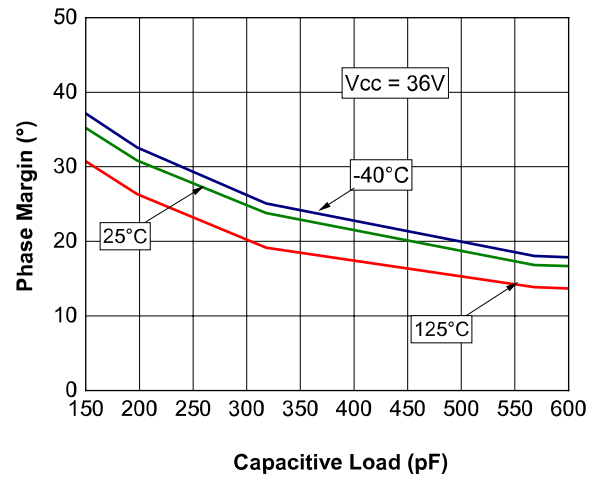

Figure 22. Short-circuit current vs. temperature

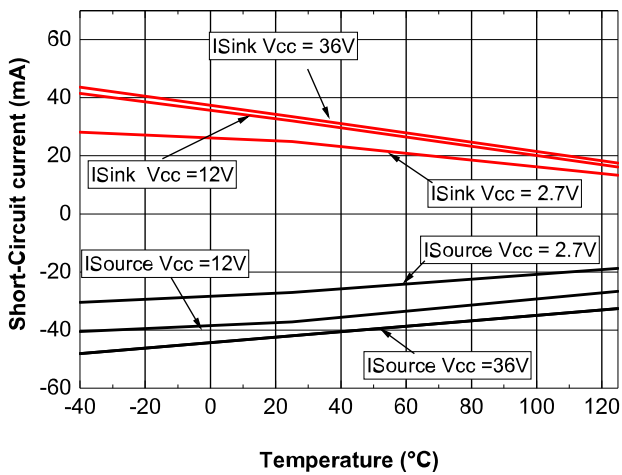

Figure 23. Output source current vs. output voltage at $V_{CC} = 2.7\text{ V}$

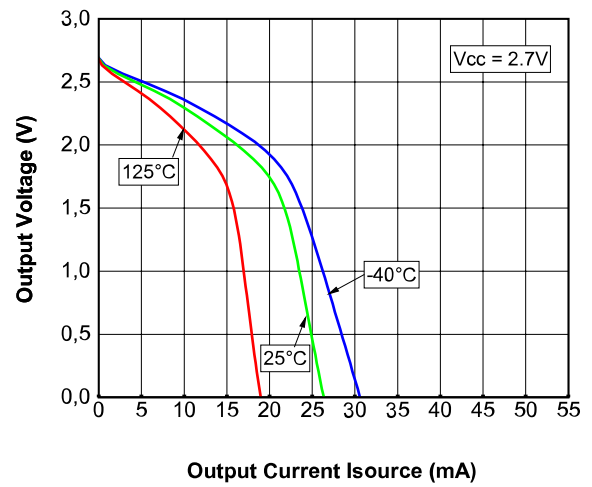

Figure 24. Output source current vs. output voltage at $V_{CC} = 12\text{ V}$

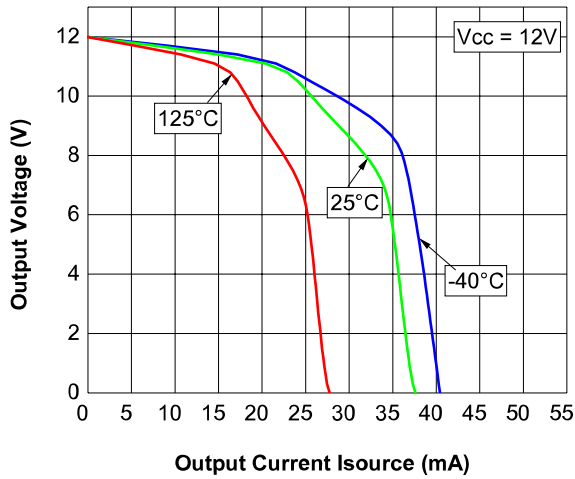

Figure 25. Output source current vs. output voltage at $V_{CC} = 36\text{ V}$

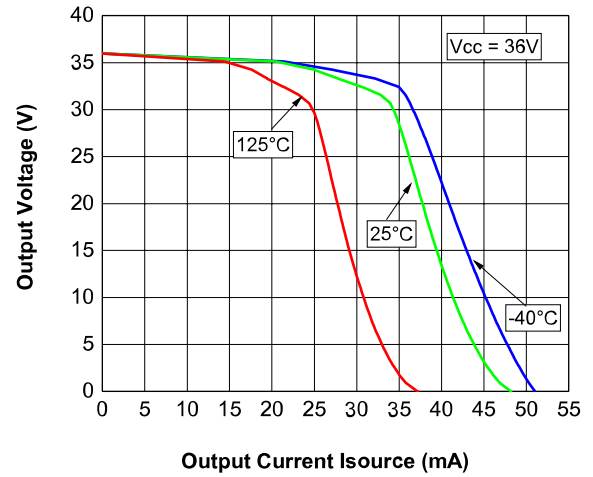

Figure 26. Output sink current vs. output voltage at $V_{CC} = 2.7\text{ V}$

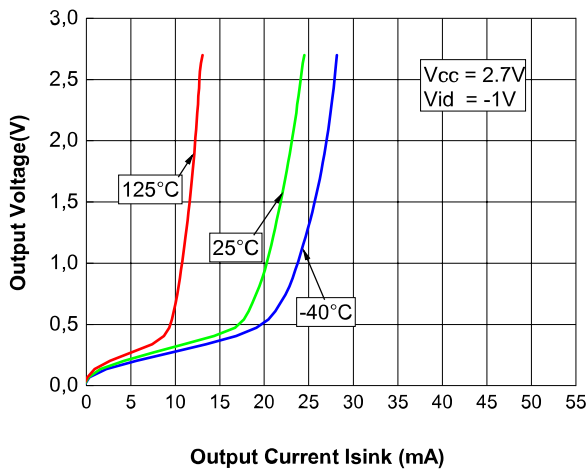

Figure 27. Output sink current vs. output voltage at $V_{CC} = 12\text{ V}$

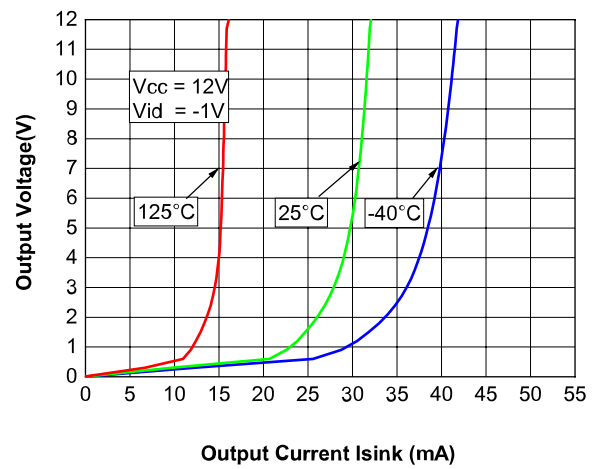

Figure 28. Output sink current vs. output voltage at $V_{CC} = 36\text{ V}$

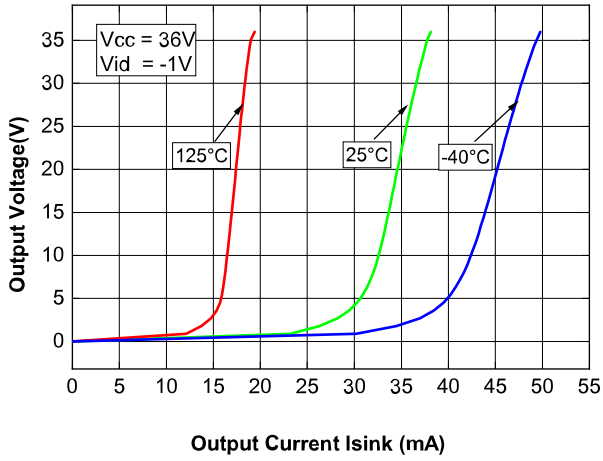

Figure 29. Slew rate at $V_{CC} = 2.7\text{ V}$

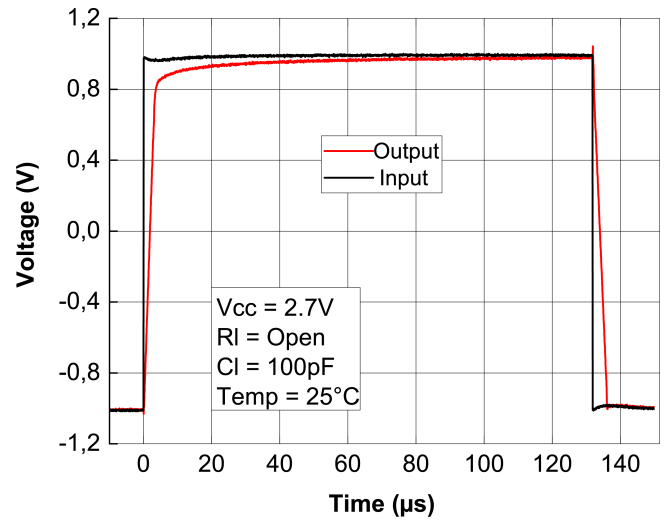

Figure 30. Slew rate at $V_{CC} = 12\text{ V}$

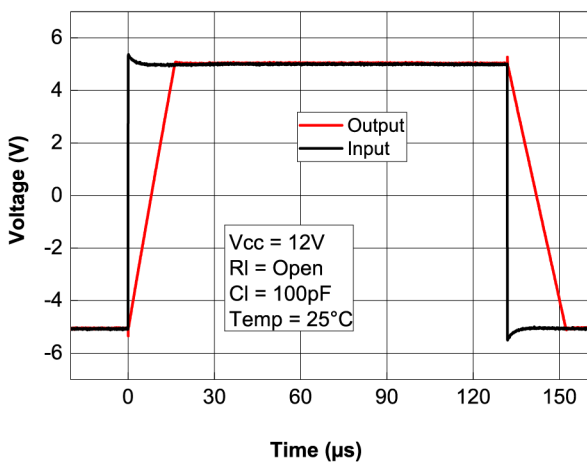

Figure 31. Slew rate at $V_{CC} = 36\text{ V}$

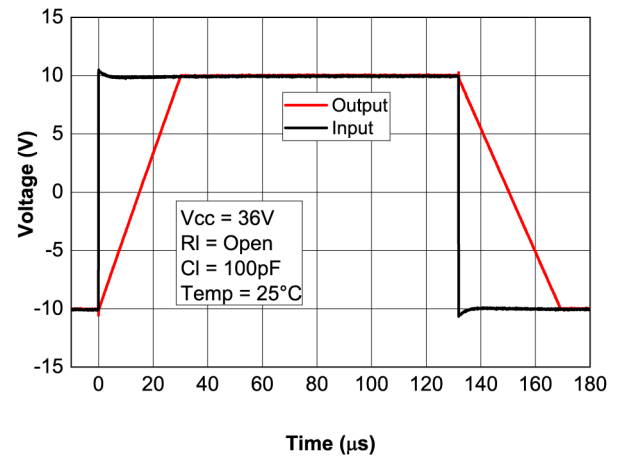

Figure 32. Slew rate vs. temperature at $V_{CC} = 36\text{ V}$

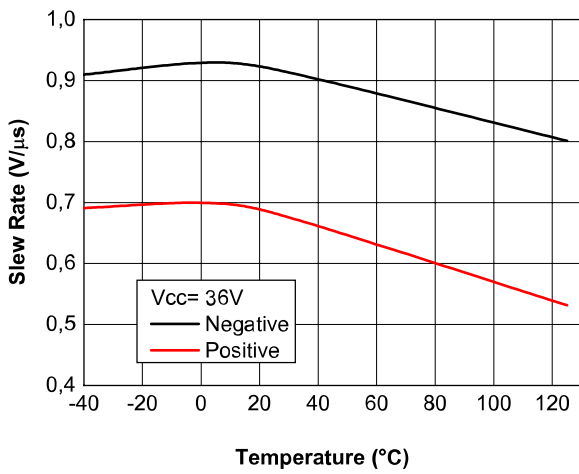

Figure 33. Small signal step response

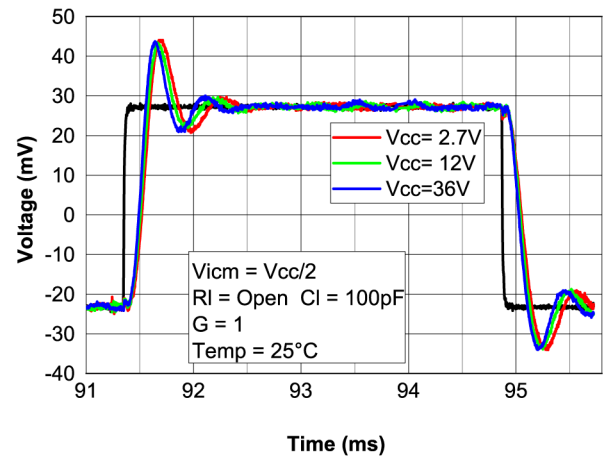

Figure 34. Maximum output voltage vs. frequency

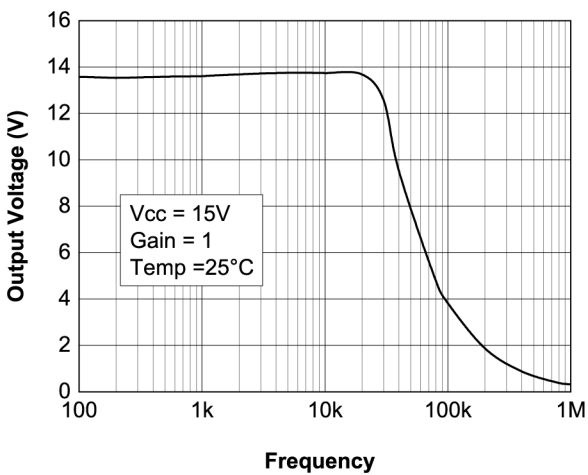

Figure 35. THD+Noise vs. frequency

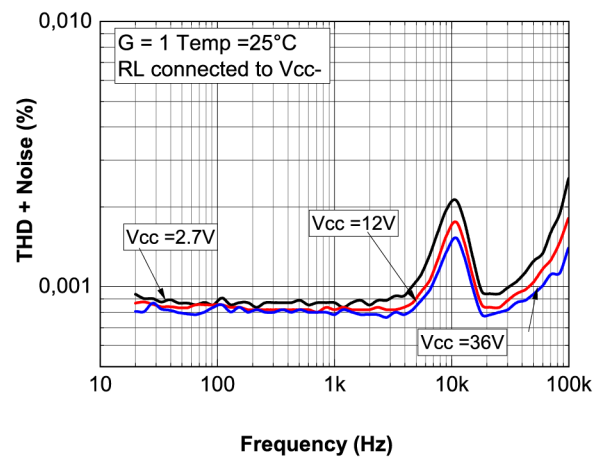

Figure 36. THD+Noise vs. output voltage

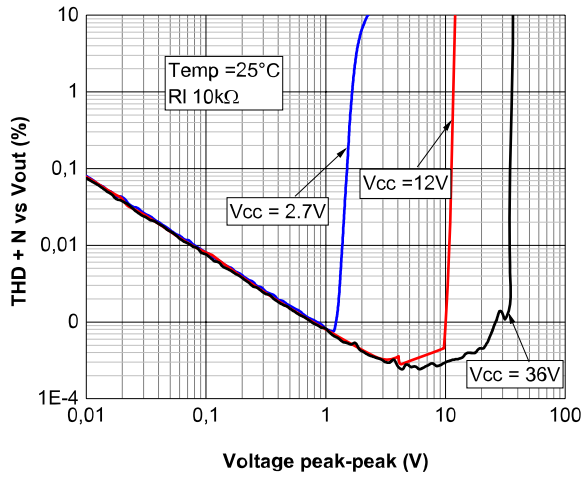

Figure 37. Cross talk vs. frequency

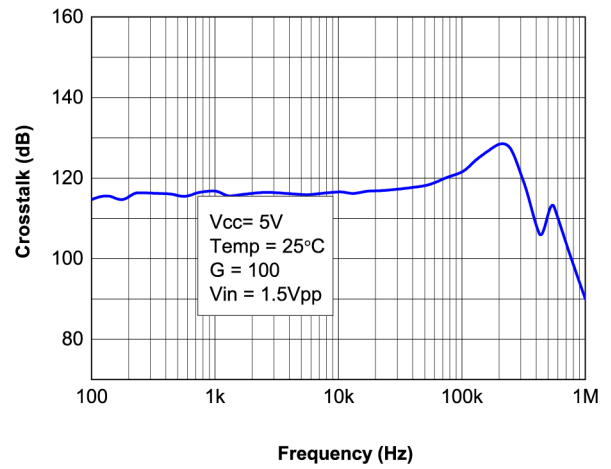
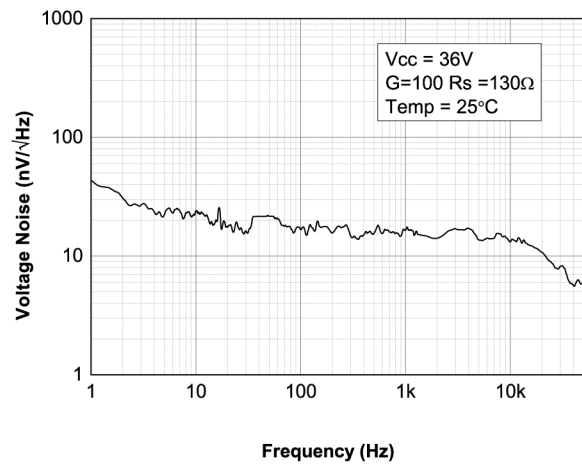

Figure 38. Equivalent input noise voltage vs. frequency



5 Package information

In order to meet environmental requirements, ST offers these devices in different grades of **ECOPACK** packages, depending on their level of environmental compliance. ECOPACK specifications, grade definitions and product status are available at: www.st.com. ECOPACK is an ST trademark.

5.1 SOT23-5 package information

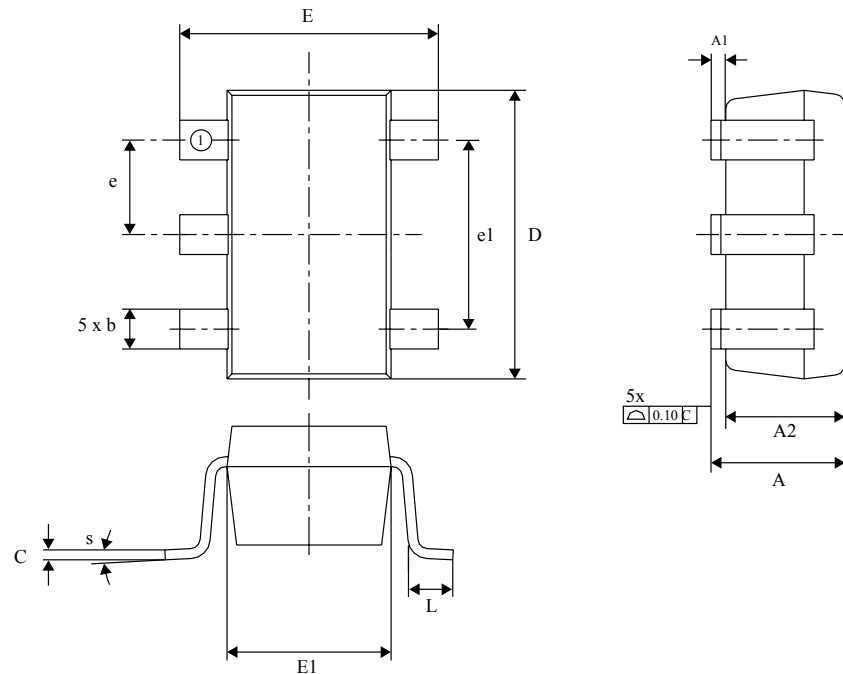
Figure 39. SOT23-5 package outline

SOT23-5

Table 9. SOT23-5 mechanical data

Symbol	Millimeters			Inches ⁽¹⁾		
	Min.	Typ.	Max.	Min.	Typ.	Max.
A			1.45			0.057
A1	0.00		0.15	0.000		0.006
A2	0.90	1.15	1.30	0.035	0.045	0.051
b	0.30		0.50	0.012		0.020
c	0.08		0.22	0.003		0.009
D		2.90			0.114	
E		2.80			0.110	
E1		1.60			0.063	
e		0.95			0.037	
e1		1.90			0.075	
L	0.30	0.45	0.60	0.012	0.018	0.024
θ	0	4	8	0	4	8

1. Values in inches are converted from mm and rounded to 4 decimal digits.

Figure 40. SOT23-5 recommended footprint

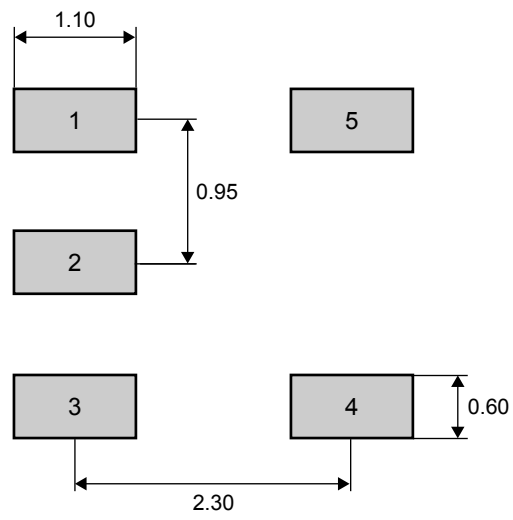

5.2 SO8 package information

Figure 41. SO8 package outline

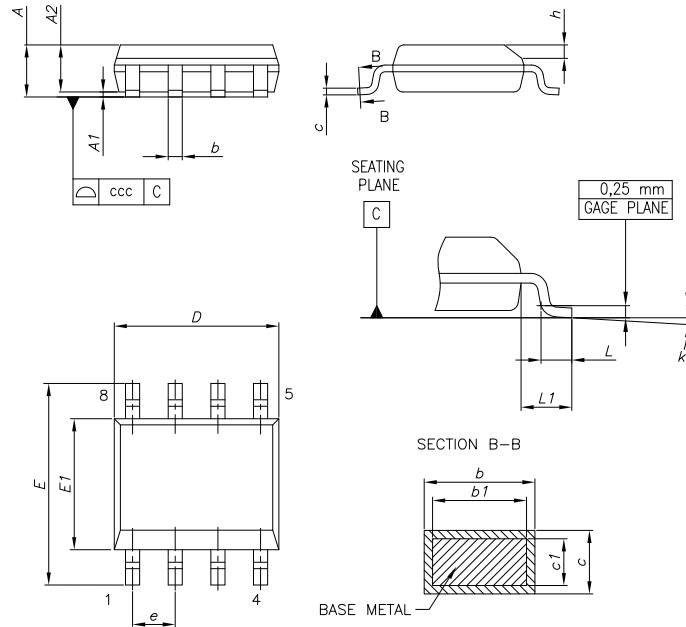

0016023_So-807_fig2_Rev10

Table 10. SO8 mechanical data

Dim.	mm		
	Min.	Typ.	Max.
A			1.75
A1	0.10		0.25
A2	1.25		
b	0.31		0.51
b1	0.28		0.48
c	0.10		0.25
c1	0.10		0.23
D	4.80	4.90	5.00
E	5.80	6.00	6.20
E1	3.80	3.90	4.00
e		1.27	
h	0.25		0.50
L	0.40		1.27
L1		1.04	
L2		0.25	
k	0°		8°
ccc			0.10

Figure 42. SO8 recommended footprint

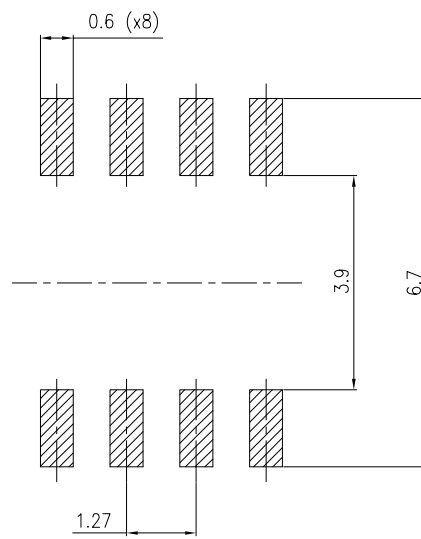

5.3 MiniSO8 package information

Figure 43. MiniSO8 package outline

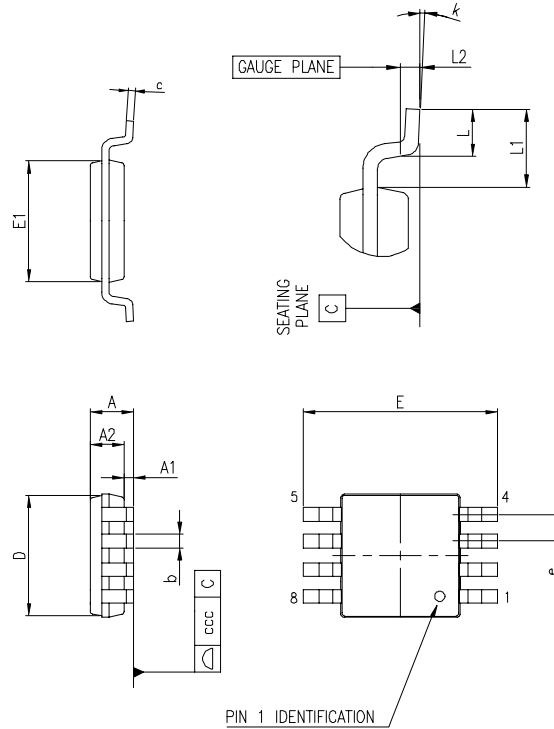
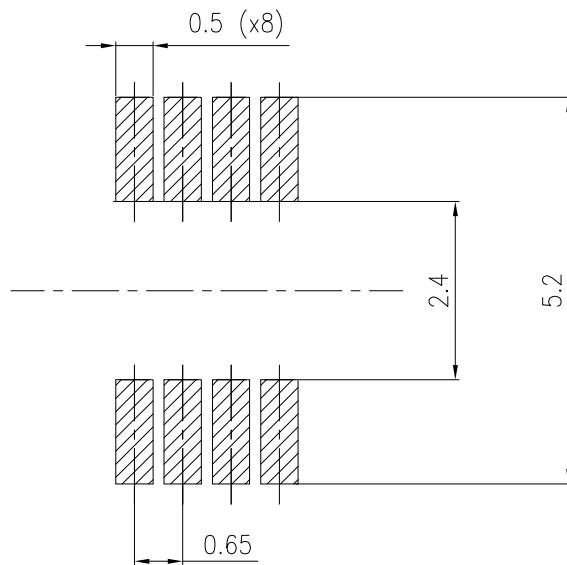
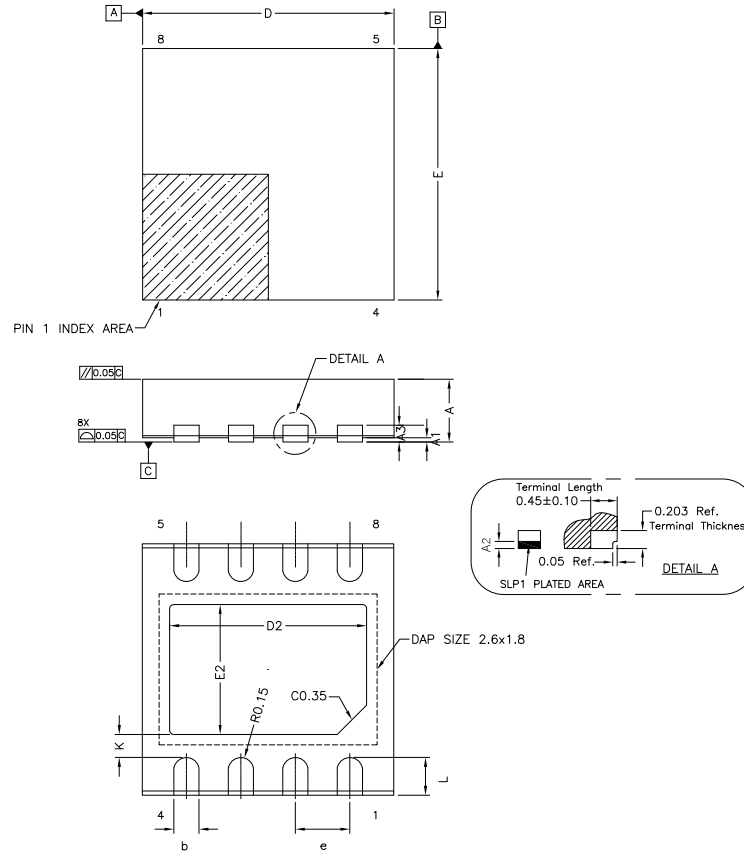

Table 11. MiniSO8 mechanical data

Dim.	Millimeters			Inches		
	Min.	Typ.	Max.	Min.	Typ.	Max.
A			1.1			0.043
A1	0		0.15	0		0.006
A2	0.75	0.85	0.95	0.03	0.033	0.037
b	0.22		0.4	0.009		0.016
c	0.08		0.23	0.003		0.009
D	2.8	3	3.2	0.11	0.118	0.126
E	4.65	4.9	5.15	0.183	0.193	0.203
E1	2.8	3	3.1	0.11	0.118	0.122
e		0.65			0.026	
L	0.4	0.6	0.8	0.016	0.024	0.031
L1		0.95			0.037	
L2		0.25			0.01	
k	0°		8°	0°		8°
ccc			0.1			0.004

Figure 44. MiniSO8 recommended footprint



5.4 DFN8 3x3 wettable flanks package information (package code: A03Y)
Figure 45. DFN8 3x3 package outline and mechanical data

Table 12. DFN8 3x3 mechanical data

Symbol	mm		
	Min.	Typ.	Max.
A	0.70	0.75	0.80
A1	0.0		0.05
A2	0.10		
A3		0.20 Ref.	
b	0.25	0.30	0.35
D	2.95	3.00	3.05
D2	2.25	2.35	2.45
e		0.65 BSC	
E	2.95	3.00	3.05
E2	1.45	1.55	1.65
L	0.35	0.45	0.55
K		0.275 Ref.	

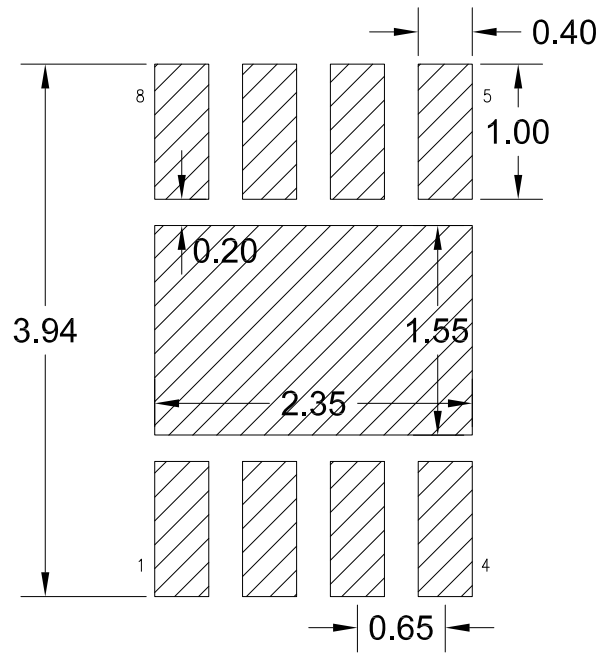
Figure 46. DFN8 3x3 footprint data



5.5 SO14 package information

Figure 47. SO14 package outline

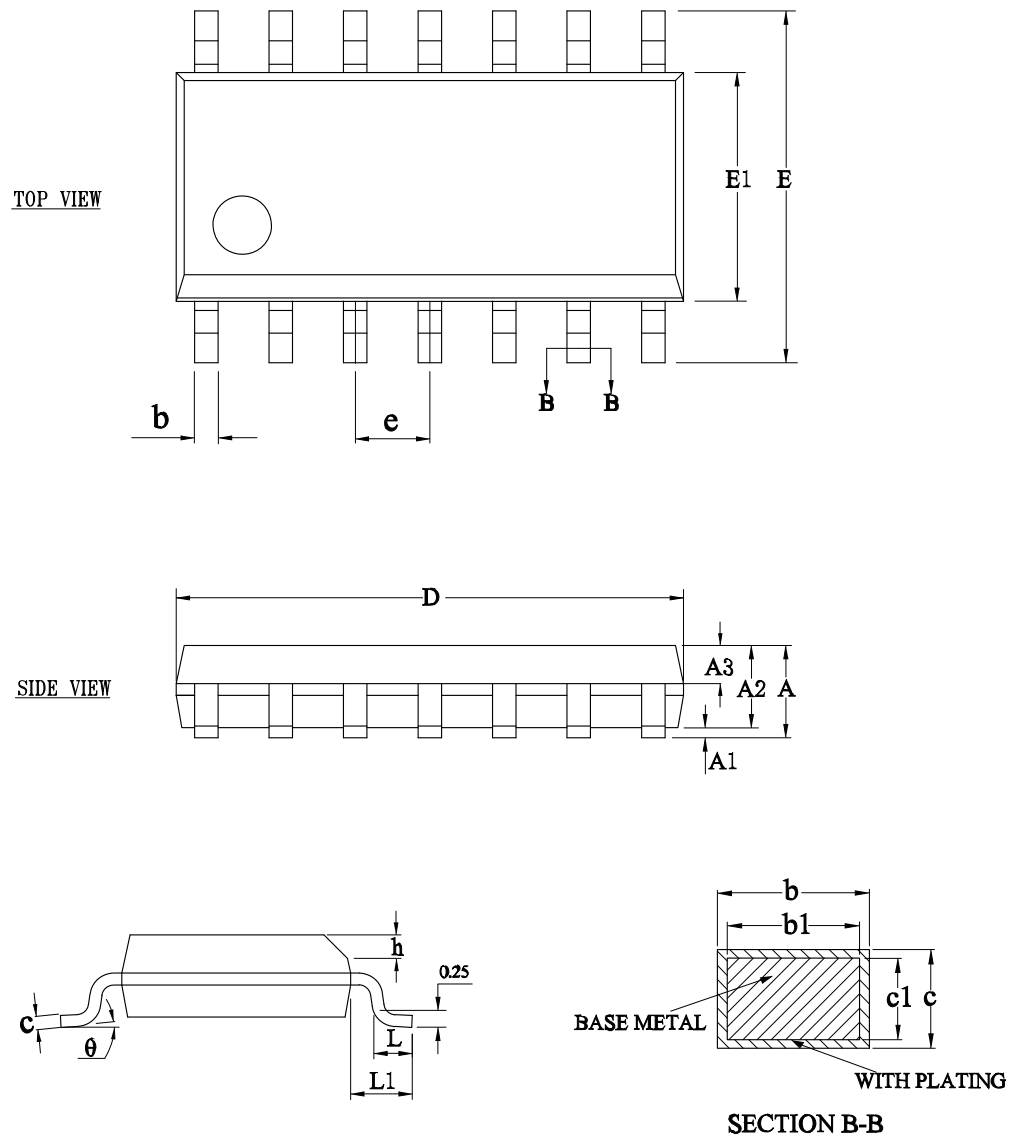
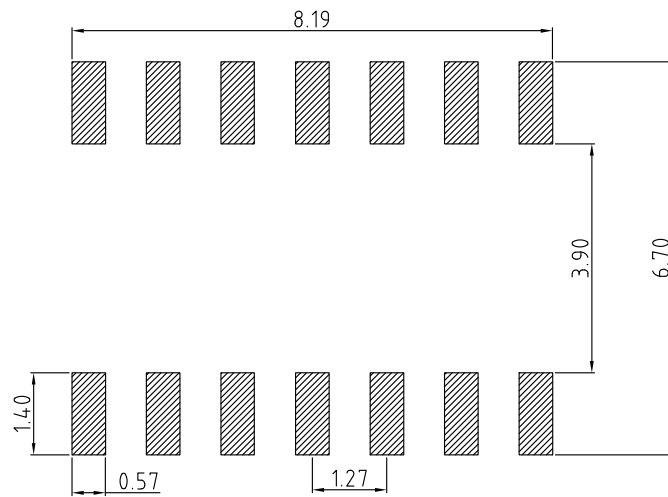

Table 13. SO14 package mechanical data

Dim.	mm		
	Min.	Typ.	Max.
A			1.75
A1	0.10		0.225
A2	1.30	1.40	1.50
A3	0.60	0.65	0.70
b	0.39		0.47
b1	0.38	0.41	0.44
c	0.20		0.24
c1	0.19	0.20	0.21
D	8.55	8.65	8.75
E	5.80	6.00	6.20
E1	3.80	3.90	4.00
e	1.27 BSC		
h	0.25		0.50
L	0.50		0.80
L1	1.05 REF		
	0		8°

Figure 48. SO14 recommended footprint

5.6 TSSOP14 package information

Figure 49. TSSOP14 package outline

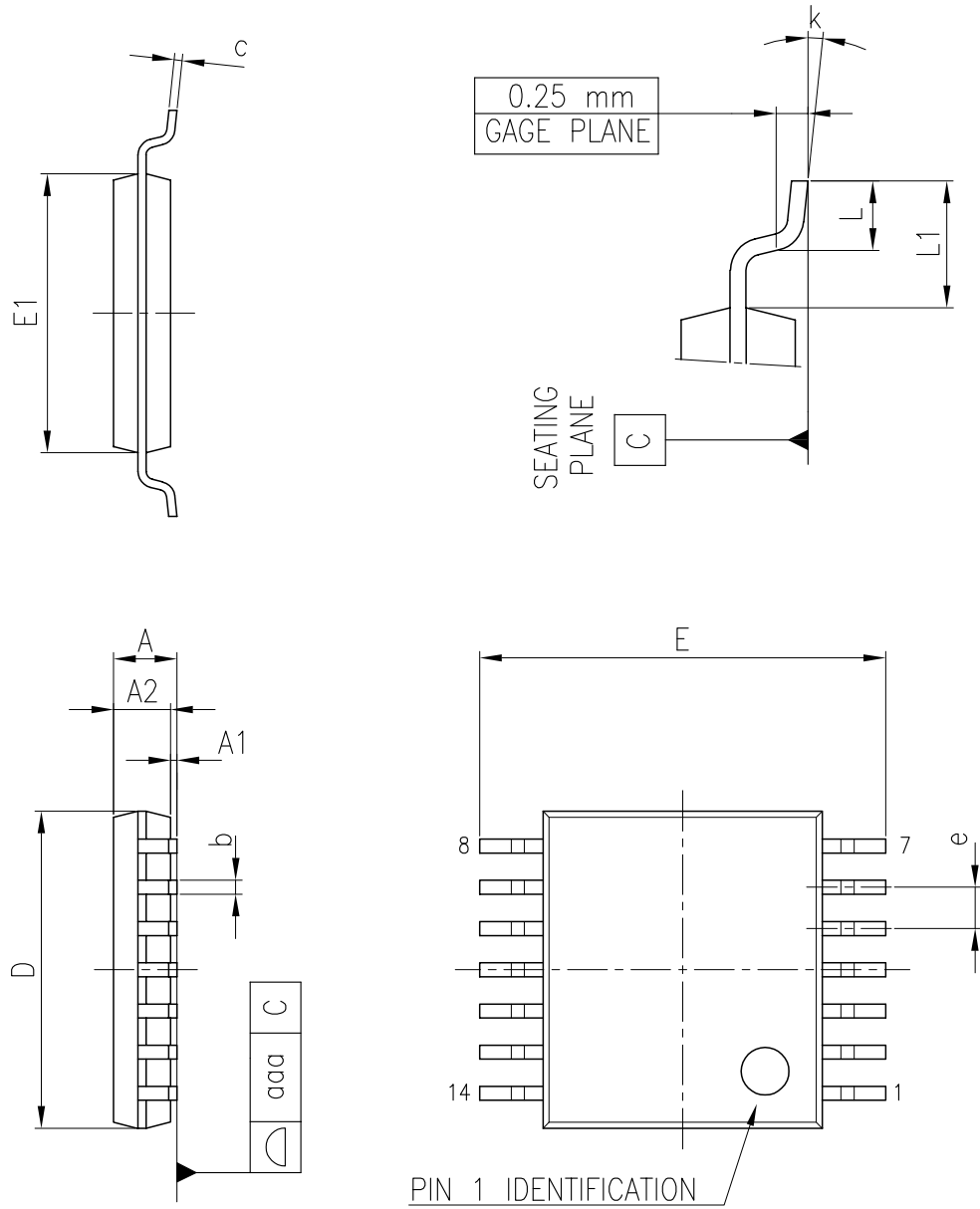

Table 14. TSSOP14 package mechanical data

Dim.	mm		
	Min.	Typ.	Max.
A			1.20
A1	0.05		0.15
A2	0.80	1.00	1.05
b	0.19		0.30
c	0.09		0.20
D	4.90	5.00	5.10
E	6.20	6.40	6.60
E1	4.30	4.40	4.50
e		0.65	
L	0.45	0.60	0.75
L1		1.00	
k	0°		8°
aaa			0.10

6 Ordering information

Table 15. Order code

Order code	Package	Packaging	Marking
TSB621ILT	SOT23-5	Tape & Reel	K2K
TSB621IYLT ⁽¹⁾			K2L
TSB622IDT	SO8		TSB622I
TSB622IYDT ⁽¹⁾			TSB622IY
TSB622IST	MiniSO8		K2K
TSB622IYST ⁽¹⁾			K2L
TSB622IQ3T	DFN8 3x3 WF		K2K
TSB622IYQ3T ⁽¹⁾			K2L
TSB624IDT	SO14		TSB624I
TSB624IYDT ⁽¹⁾			TSB624IY
TSB624IPT	TSSOP14		TSB624I
TSB624IYPT ⁽¹⁾			TSB624IY

1. Qualified and characterized according to AEC Q100 and Q003 or equivalent, advanced screening according to AEC Q001 & Q002 or equivalent.

Revision history

Table 16. Document revision history

Date	Revision	Changes
03-Nov-2021	1	Initial release.
15-Feb-2022	2	Updated Figure 2.
01-Dec-2022	3	Added new TSSOP14, SO14 and SOT23-5 packages in Section 5 Package information . Updated Section 1 Pin connections , Table 4. Absolute maximum ratings , phase margin typical value in Table 6 , Table 7 , Table 8 and Section 6 Ordering information .

Contents

1	Pin connections	2
2	Absolute maximum ratings and operating conditions	4
3	Electrical characteristics	5
4	Typical performance characteristics	8
5	Package information	17
5.1	SOT23-5 package information	18
5.2	SO8 package information	20
5.3	MiniSO8 package information	22
5.4	DFN8 3x3 wettable flanks package information (package code: A03Y)	24
5.5	SO14 package information	26
5.6	TSSOP14 package information	28
6	Ordering information	30
	Revision history	31

List of tables

Table 1.	TSB621 pin description.	2
Table 2.	TSB622 pin description.	2
Table 3.	TSB624 pin description.	3
Table 4.	Absolute maximum ratings	4
Table 5.	Operating conditions	4
Table 6.	Electrical characteristics $V_{CC+} = 2.7\text{ V}$, $V_{CC-} = 0\text{ V}$, $V_{icm} = V_{CC}/2$, $T = 25\text{ °C}$, $R_L = 10\text{ k}\Omega$ connected to $V_{CC}/2$ (unless otherwise specified)	5
Table 7.	Electrical characteristics $V_{CC+} = 12\text{ V}$, $V_{CC-} = 0\text{ V}$, $V_{icm} = V_{CC}/2$, $T = 25\text{ °C}$, $R_L = 10\text{ k}\Omega$ connected to $V_{CC}/2$ (unless otherwise specified)	6
Table 8.	Electrical characteristics $V_{CC+} = 36\text{ V}$, $V_{CC-} = 0\text{ V}$, $V_{icm} = V_{CC}/2$, $T = 25\text{ °C}$, $R_L = 10\text{ k}\Omega$ connected to $V_{CC}/2$ (unless otherwise specified)	7
Table 9.	SOT23-5 mechanical data	18
Table 10.	SO8 mechanical data	20
Table 11.	MiniSO8 mechanical data	22
Table 12.	DFN8 3x3 mechanical data	24
Table 13.	SO14 package mechanical data	27
Table 14.	TSSOP14 package mechanical data	29
Table 15.	Order code	30
Table 16.	Document revision history	31

List of figures

Figure 1.	TSB621 pin connections (top view)	2
Figure 2.	TSB622 pin connections (top view)	2
Figure 3.	TSB624 pin connections (top view)	3
Figure 4.	Supply current vs. supply voltage	8
Figure 5.	Input offset voltage distribution at $V_{CC} = 2.7\text{ V}$	8
Figure 6.	Input offset voltage distribution at $V_{CC} = 12\text{ V}$	8
Figure 7.	Input offset voltage distribution at $V_{CC} = 36\text{ V}$	8
Figure 8.	Input offset voltage vs. temperature at $V_{CC} = 36\text{ V}$	9
Figure 9.	Input offset voltage temperature variation distribution at $V_{CC} = 36\text{ V}$	9
Figure 10.	Input offset voltage temperature variation distribution at $V_{CC} = 36\text{ V}$	9
Figure 11.	Input offset voltage vs. common-mode voltage at $V_{CC} = 36\text{ V}$	9
Figure 12.	Common-mode reject. ratio CMR at $V_{CC} = 5\text{ V}$	10
Figure 13.	Supply voltage rejection ratio SVR at $V_{CC} = 5\text{ V}$	10
Figure 14.	Input bias current vs. temperature	10
Figure 15.	Bode diagram at $V_{CC} = 2.7\text{ V}$	10
Figure 16.	Bode diagram at $V_{CC} = 12\text{ V}$	11
Figure 17.	Bode diagram at $V_{CC} = 36\text{ V}$	11
Figure 18.	Overshoot vs. capacitive load at $V_{CC} = 36\text{ V}$	11
Figure 19.	Phase margin vs. capacitive load at $V_{CC} = 2.7\text{ V}$	11
Figure 20.	Phase margin vs. capacitive load at $V_{CC} = 12\text{ V}$	12
Figure 21.	Phase margin vs. capacitive load at $V_{CC} = 36\text{ V}$	12
Figure 22.	Short-circuit current vs. temperature	12
Figure 23.	Output source current vs. output voltage at $V_{CC} = 2.7\text{ V}$	12
Figure 24.	Output source current vs. output voltage at $V_{CC} = 12\text{ V}$	13
Figure 25.	Output source current vs. output voltage at $V_{CC} = 36\text{ V}$	13
Figure 26.	Output sink current vs. output voltage at $V_{CC} = 2.7\text{ V}$	13
Figure 27.	Output sink current vs. output voltage at $V_{CC} = 12\text{ V}$	13
Figure 28.	Output sink current vs. output voltage at $V_{CC} = 36\text{ V}$	14
Figure 29.	Slew rate at $V_{CC} = 2.7\text{ V}$	14
Figure 30.	Slew rate at $V_{CC} = 12\text{ V}$	14
Figure 31.	Slew rate at $V_{CC} = 36\text{ V}$	14
Figure 32.	Slew rate vs. temperature at $V_{CC} = 36\text{ V}$	15
Figure 33.	Small signal step response	15
Figure 34.	Maximum output voltage vs. frequency	15
Figure 35.	THD+Noise vs. frequency	15
Figure 36.	THD+Noise vs. output voltage	16
Figure 37.	Cross talk vs. frequency	16
Figure 38.	Equivalent input noise voltage vs. frequency	16
Figure 39.	SOT23-5 package outline	18
Figure 40.	SOT23-5 recommended footprint	19
Figure 41.	SO8 package outline	20
Figure 42.	SO8 recommended footprint	21
Figure 43.	MiniSO8 package outline	22
Figure 44.	MiniSO8 recommended footprint	23
Figure 45.	DFN8 3x3 package outline and mechanical data	24
Figure 46.	DFN8 3x3 footprint data	25
Figure 47.	SO14 package outline	26
Figure 48.	SO14 recommended footprint	27
Figure 49.	TSSOP14 package outline	28

IMPORTANT NOTICE – READ CAREFULLY

STMicroelectronics NV and its subsidiaries (“ST”) reserve the right to make changes, corrections, enhancements, modifications, and improvements to ST products and/or to this document at any time without notice. Purchasers should obtain the latest relevant information on ST products before placing orders. ST products are sold pursuant to ST’s terms and conditions of sale in place at the time of order acknowledgment.

Purchasers are solely responsible for the choice, selection, and use of ST products and ST assumes no liability for application assistance or the design of purchasers’ products.

No license, express or implied, to any intellectual property right is granted by ST herein.

Resale of ST products with provisions different from the information set forth herein shall void any warranty granted by ST for such product.

ST and the ST logo are trademarks of ST. For additional information about ST trademarks, refer to www.st.com/trademarks. All other product or service names are the property of their respective owners.

Information in this document supersedes and replaces information previously supplied in any prior versions of this document.

© 2022 STMicroelectronics – All rights reserved

X-ON Electronics

Largest Supplier of Electrical and Electronic Components

Click to view similar products for [Operational Amplifiers - Op Amps](#) category:

Click to view products by [STMicroelectronics](#) manufacturer:

Other Similar products are found below :

[430227FB](#) [LT1678IS8](#) [NCV33202DMR2G](#) [NJM324E](#) [M38510/13101BPA](#) [NTE925](#) [AZV358MTR-G1](#) [AP4310AUMTR-AG1](#)
[AZV358MMTR-G1](#) [SCY33178DR2G](#) [NCV20034DR2G](#) [NTE778S](#) [NTE871](#) [NTE937](#) [NJU7057RB1-TE2](#) [SCY6358ADR2G](#)
[NJM2904CRB1-TE1](#) [UPC4570G2-E1-A](#) [UPC4741G2-E1-A](#) [UPC4574GR-9LG-E1-A](#) [NJM8532RB1-TE1](#) [EL2250CS](#) [EL5100IS](#) [EL5104IS](#)
[EL5127CY](#) [EL5127CYZ](#) [EL5133IW](#) [EL5152IS](#) [EL5156IS](#) [EL5162IS](#) [EL5202IY](#) [EL5203IY](#) [EL5204IY](#) [EL5210CS](#) [EL5210CYZ](#)
[EL5211IYE](#) [EL5220CY](#) [EL5223CLZ](#) [EL5223CR](#) [EL5224ILZ](#) [EL5227CLZ](#) [EL5227CRZ](#) [EL5244CS](#) [EL5246CS](#) [EL5246CSZ](#) [EL5250IY](#)
[EL5251IS](#) [EL5257IS](#) [EL5260IY](#) [EL5261IS](#)