

## Time-of-Flight ranging sensor with multi target detection

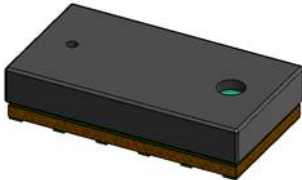

### Features

- Fully integrated miniature module
  - Emitter: 940 nm invisible laser (VCSEL) and its analog driver
  - Low-power microcontroller running advanced digital firmware
  - Size: 4.4 x 2.4 x 1 mm
- Fast, accurate distance ranging
  - Histogram based technology
  - Up to 300 cm+ detection with full field of view (FoV)
  - Immune to cover glass cross-talk and fingerprint smudge at long distance with patented algorithms (direct ToF)
  - Dynamic fingerprint smudge compensation
  - Short distance, high accuracy linearity
  - Multi target detection and distance measurement
- Typical full FoV: 25 °
- Easy integration
  - Reflowable component
  - Part-to-part or generic shape crosstalk calibration available
  - Single power supply
  - Works with many types of cover glass materials
  - I<sup>2</sup>C interface (up to 1 MHz)
  - Xshutdown (reset) and interrupt GPIO to optimize ranging operation
  - C and Linux full set of software drivers for turnkey ranging

### Application

- Service robots and vacuum cleaners (wall following and fast obstacle detection)
- Sanitary (robust user detection whatever the target reflectance)
- Smart buildings and smart lighting (user detection to wake up devices)
- IoT (user and object detection)
- Laser assisted autofocus (AF): enhances the camera AF system speed and robustness, especially in difficult scenes (low light and low contrast); ideal companion for phase-detection autofocus (PDAF) sensors.
- Video focus tracking assistance

## Description

The VL53L3CX is the latest Time-of-Flight (ToF) product from STMicroelectronics and embeds ST's third generation FlightSense patented technology. It combines a high performance proximity and ranging sensor, with multi target distance measurements and automatic smudge correction. The miniature reflowable package integrates a single photon avalanche diode (SPAD) array and physical infrared filters to achieve the best ranging performance in various ambient lighting conditions, with a wide range of cover glass windows.

The VL53L3CX combines the benefits of a high-performance proximity sensor, with excellent short distance linearity, together with ranging capability up to 3 m.

With patented algorithms and ingenious module construction, the VL53L3CX is also able to detect different objects within the field of view (FoV) with depth understanding. The ST histogram algorithms allow cover glass crosstalk immunity beyond 80 cm, and dynamic smudge compensation.

# 1 Product overview

## 1.1 Technical specification

**Table 1. Technical specification**

Feature	Detail
Package	Optical LGA12
Size	4.4 x 2.4 x 1 mm
Operating voltage	2.6 to 3.5 V
Operating temperature	-20 to 85 °C
Infrared emitter	940 nm
I2C	Up to 1 MHz (Fast mode plus) serial bus Address: 0x52

## 1.2 System block diagram

**Figure 1. VL53L3CX block diagram**

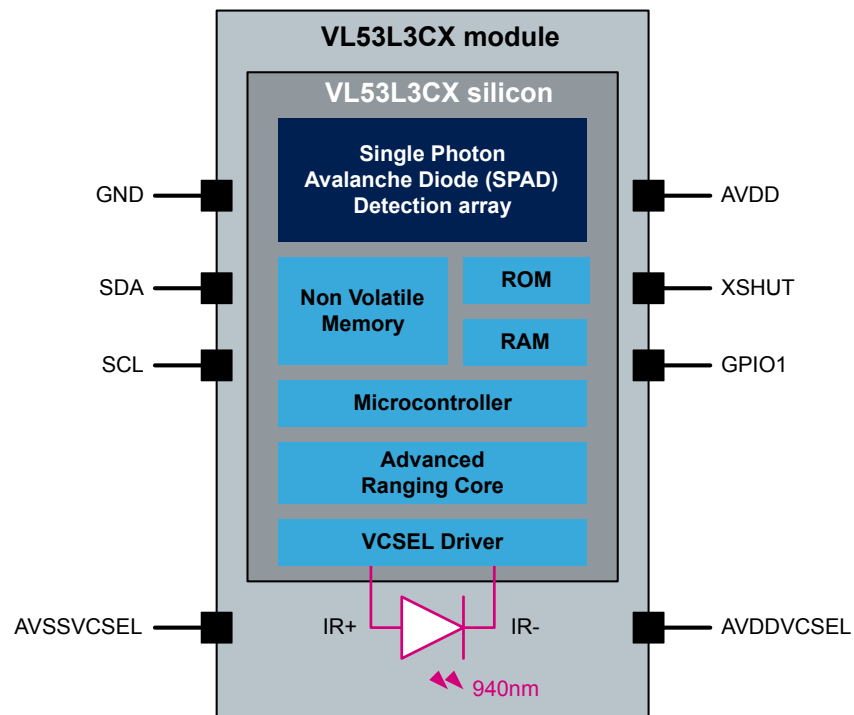

### 1.3 Device pinout

The figure below shows the pinout of the device.

**Figure 2. Device pinout (bottom view)**

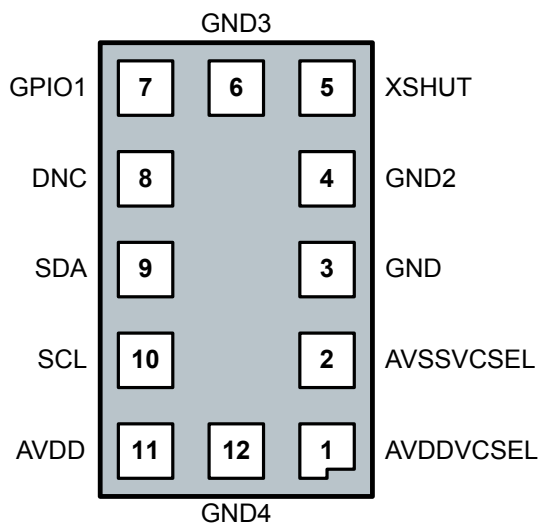

**Table 2. Device pin description**

Pin number	Signal name	Signal type	Signal description
1	AVDDVCSEL	Supply	VCSEL supply, to be connected to main supply
2	AVSSVCSEL	Ground	VCSEL ground, to be connected to main ground
3	GND		To be connected to main ground
4	GND2		To be connected to main ground
5	XSHUT	Digital input	Xshutdown pin, active low
6	GND3	Ground	To be connected to main ground
7	GPIO1	Digital output	Interrupt output. Open drain output
8	DNC	Digital input	Do not connect, must be left floating
9	SDA	Digital input/output	I2C serial data
10	SCL	Digital input	I2C serial clock input
11	AVDD	Supply	Supply, to be connected to main supply
12	GND4	Ground	To be connected to main ground

**Note:** AVSSVCSEL and GND are ground pins and can be connected together in the application schematics.

**Note:** GND2, GND3, and GND4 are standard pins that we force to the ground domain in the application schematics to avoid possible instabilities if set to other states.

## 1.4 Application schematic

The figure below shows the application schematic of the device.

**Figure 3. VL53L3CX schematic**

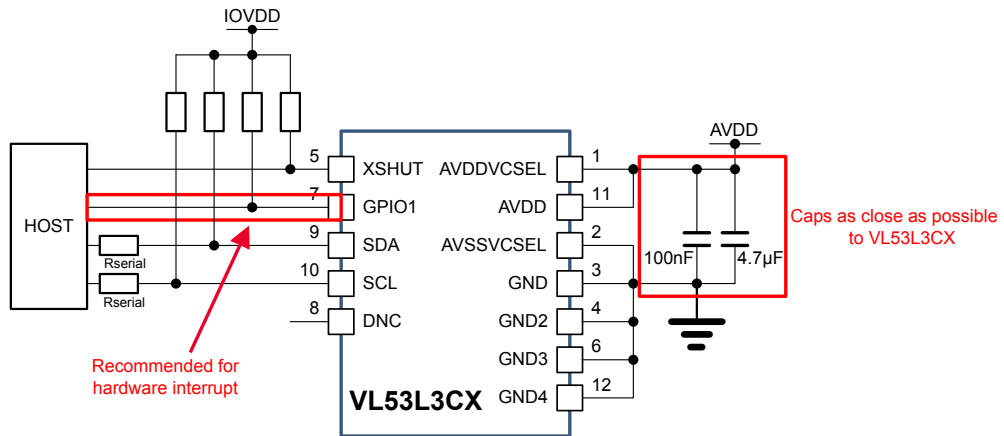

**Note:** Capacitors on the external supply AVDD should be placed as close as possible to the AVDDVCSEL and AVSSVCSEL module pins.

**Note:** External pull-up resistor values can be found in I2C-bus specification. Pull-ups are typically fitted only once per bus, near the host. For suggested values see tables below.

**Note:** XSHUT pin must always be driven to avoid leakage current. A pullup is needed if the host state is not known. XSHUT is needed to use HW standby mode (no I2C communication).

**Note:** XSHUT and GPIO1 pull up recommended values are 10 kOhms. GPIO1 should be left unconnected if not used. The tables below show recommended values for pull-up and series resistors for an AVDD of 1.8 V to 2.8 V in I2C Fast mode (up to 400 kHz) and Fast mode plus (up to 1 MHz).

**Table 3. Suggested pull-up and series resistors for I2C Fast mode**

I2C load capacitance ( $C_L$ )	Pull-up resistor (Ohms)	Series resistor (Ohms)
$C_L \leq 90$ pF	3.6 k	0
$90$ pF < $C_L \leq 140$ pF	2.4 k	0
$140$ pF < $C_L \leq 270$ pF	1.2 k	0
$270$ pF < $C_L \leq 400$ pF	0.8 k	0

**Table 4. Suggested pull-up and series resistors for I2C Fast mode plus**

I2C load capacitance ( $C_L$ )	Pull up resistor (Ohms)	Series resistor (Ohms)
$C_L \leq 90$ pF	1.5 k	100
$90$ pF < $C_L \leq 140$ pF	1 k	50
$140$ pF < $C_L \leq 270$ pF	0.5 k	50
$270$ pF < $C_L \leq 400$ pF	0.3 k	50

**Note:** For each bus line,  $C_L$  is measured in the application PCB by the customer.

## 2 Functional description

### 2.1 System functional description

The figure below shows the system level functional description. The host customer application controls the device using an API (application programming interface). The API implementation is delivered to the customer as a driver (Bare C code, or Linux driver).

The driver shares with the customer application a set of high level functions that allow control of the device Firmware (FW) like initialization, ranging start/stop, setting the system accuracy.

The driver is a turnkey solution consisting of a set of “C” functions that enable fast development of end user applications without the complication of direct multiple register access. The driver is structured in a way that it can be compiled on any kind of platform through a well abstracted platform layer. The driver package allows the user to take full advantage of the device capabilities.

A detailed description of the driver is available in the device driver user manual.

The device FW fully manages the hardware (HW) register accesses.

Section 2.2 State machine description details the Firmware state machine.

Figure 4. VL53L3CX system functional description

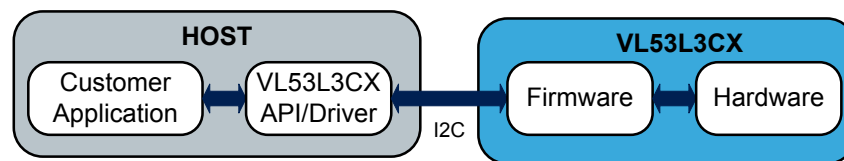

## 2.2 State machine description

The figure below shows the device state machine.

Figure 5. Device state machine

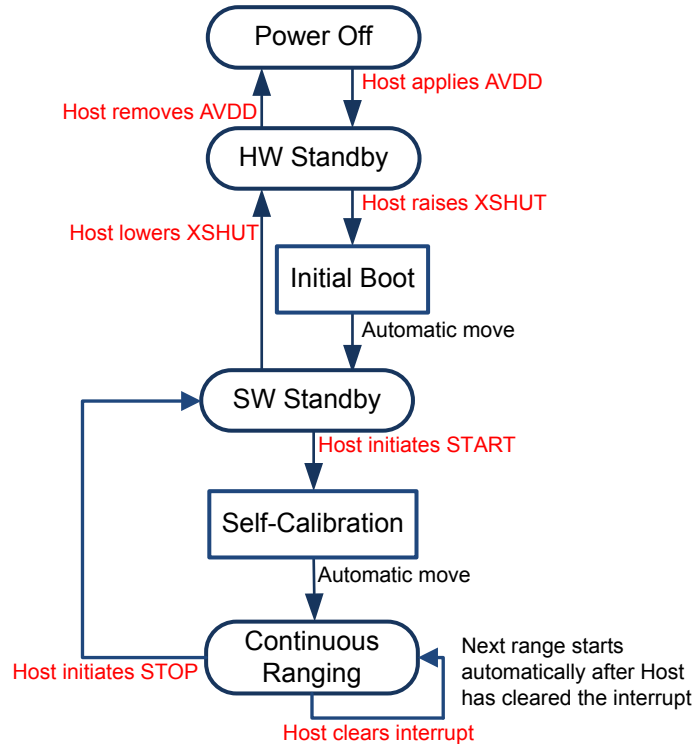

## 2.3 Customer manufacturing calibration flow

Up to three calibrations are needed to guarantee the best sensor performances. Offset and RefSpad calibration are needed in all applications. If a cover glass is used, the crosstalk calibration is needed also.

“Generic shape” crosstalk calibration is also available. In this case, part-to-part calibration is not needed and a standard set of calibration values is loaded.

The detailed procedure is provided in the device driver user manual.

## 2.4 Device programming and control

The VL53L3CX physical control interface is I2C, described in [Section 3 Control interface](#).

A software layer (driver) is provided to control the device. This avoids complex I2C register operations with turnkey functions to start, stop and read the ranging values.

The driver structure and functions are described in the device driver user manual.

## 2.5 Ranging mode description

The VL53L3CX dedicated operating mode (called “preset”) is “ranging mode”. In this mode, the software driver proposes turnkey to allow fast and easy ranging in all customer applications:

Ranging mode is the configuration to get the best of the VL53L3CX functionalities.

- Ranging mode is natively immune to cover glass crosstalk and smudge beyond 80 cm. With patented algorithms (direct ToF), a temporal filtering is possible to distinguish crosstalk from the object signal over long distances > 80 cm. A best-in-class ranging performance of 300 cm with the cover glass in place is now possible, and can be reached with any computation unlike other sensors on the market.
- Ranging mode can detect several objects concurrently within the FoV. Up to four ranges can be output simultaneously by the software driver, to indicate an object’s range. Check the latest software driver manual for further details.
- Ranging operation is performed by default at 30 Hz once the driver function is called (typical ranging operation lasts 33 ms). It includes internal housekeeping, ranging and post-processing.

*Note:* *Ranging mode requires a handshake between the host and the VL53L3CX, at each ranging operation. This handshake is mandatory to ensure the right result is read by the host to continue the ranging operation.*  
Please refer to [Section 2.10 Handshake management](#).

## 2.6 Digital processing

Digital processing is the final operation of the ranging sequence that computes, validates or rejects a ranging measurement. Part of this processing is performed by the VL53L3CX internal Firmware and completed on the host processor running the software driver.

At the end of digital processing, the ranging distance is computed by the VL53L3CX itself. If the distance cannot be measured (no target or weak signal), a corresponding status error code is generated and can be read by the host.

A full description of the status errors is provided inside the device driver user manual.

## 2.7 Reading the results

The VL53L3CX software driver provides turnkey functions to read output results after the measurement:

- Signal rate per object detected
- Ranging distance per object detected
- Min. and max. distances where object is located

A full description is provided inside the device driver user manual.



## 2.8 Power sequence

### 2.8.1 Power up and boot sequence

There are two options available for device power up/boot.

**Option 1:** The XSHUT pin is connected and controlled from the host.

This option optimizes power consumption as the device can be completely powered off when not used, and then woken up through the host GPIO (using the XSHUT pin).

HW Standby mode is defined as the period when AVDD is present and XSHUT is low

**Figure 6. Power up and boot sequence**

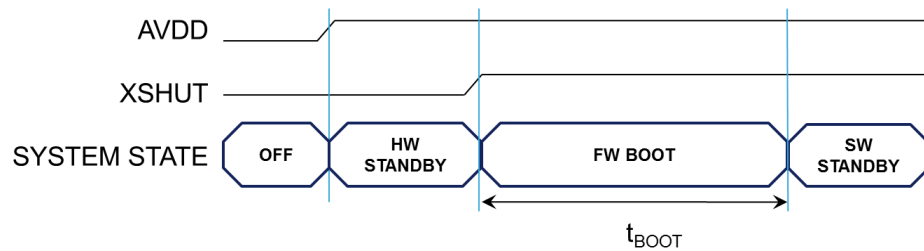

**Option 2:** The XSHUT pin is not controlled by the host, it is tied to AVDD through the pull-up resistor.

When the XSHUT pin is not controlled, the power-up sequence is presented in the figure below. In this case, the device goes automatically to SW STANDBY after FW BOOT, without entering HW STANDBY.

**Figure 7. Power up and boot sequence with XSHUT not controlled**

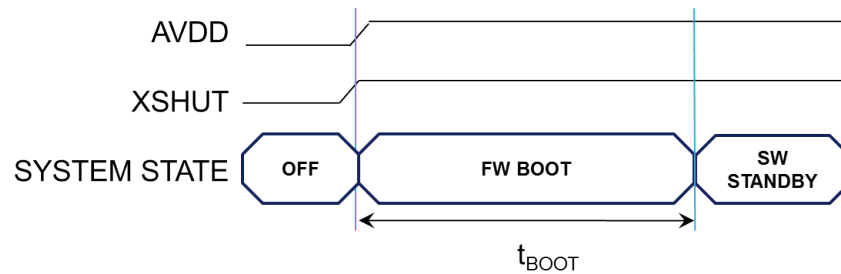

*Note:* In both cases,  $t_{BOOT}$  is 1.2 ms max.

*Note:* In both cases, XSHUT has to be raised only when AVDD is tied on.

*Note:* The VL53L3CX must only exit reset when there is no existing I2C transaction taking place on the bus i.e. do not raise the XSHUT when there is an existing I2C command in progress, wait until the current I2C command has completed.

## 2.9 Ranging sequence

Figure 8. Ranging sequence

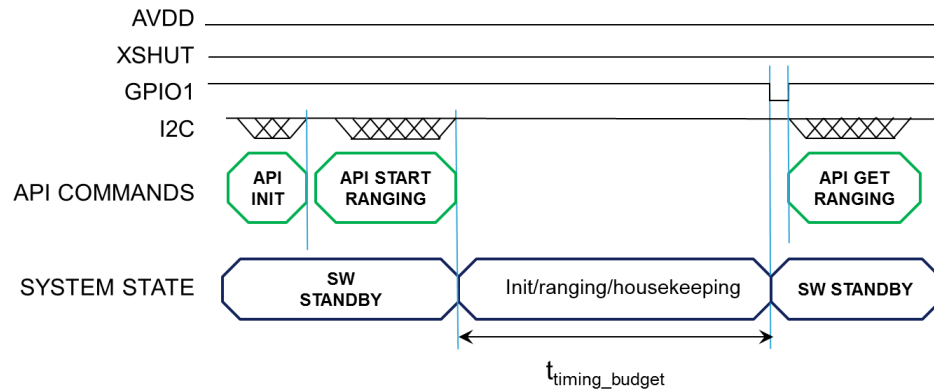

## 2.10 Handshake management

Once a ranging measurement is available, an interrupt is generated. This is communicated to the host as a physical signal on the GPIO1 pin, which is driven low, and the output of a driver function. The former operating method is called “hardware interrupt”, and the latter is referred as “polling mode”.

Once the host reads the result, the interrupt is cleared by the driver and the ranging sequence can repeat. If the interrupt is not cleared, the ranging operation inside the VL53L3CX is on hold. The interrupt behavior allows a good synchronization between the VL53L3CX and the host, avoids losing results if the host is not available to acquire or process the data.

It is strongly recommended to use the hardware interrupt pin to manage this handshake.

For more details please refer to the device driver user manual.

### 3 Control interface

This section specifies the control interface. The I2C interface uses two signals: serial data line (SDA) and serial clock line (SCL). Each device connected to the bus uses a unique address and a simple master / slave relationships exists.

Both SDA and SCL lines are connected to a positive supply voltage using pull-up resistors located on the host. Lines are only actively driven low. A high condition occurs when lines are floating and the pull-up resistors pull lines up. When no data is transmitted both lines are high.

Clock signal (SCL) generation is performed by the master device. The master device initiates data transfer. The I2C bus on the product device has a maximum speed of 1 Mbits/s and uses a default device address of 0x52.

**Figure 9. Data transfer protocol**

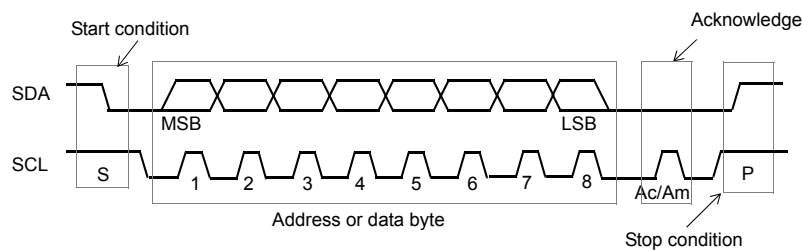

Information is packed in 8-bit packets (bytes) always followed by an acknowledge bit, Ac for VL53L3CX acknowledge and Am for master acknowledge (host bus master). The internal data is produced by sampling SDA at a rising edge of SCL. The external data must be stable during the high period of SCL. The exceptions to this are start (S) or stop (P) conditions when SDA falls or rises respectively, while SCL is high.

A message contains a series of bytes preceded by a start condition and followed by either a stop or repeated start (another start condition but without a preceding stop condition) followed by another message. The first byte contains the device address (0x52) and also specifies the data direction. If the least significant bit is low (that is, 0x52) the message is a master-write-to-the-slave. If the LSB is set (that is, 0x53) then the message is a master-read-from-the-slave.

**Figure 10. VL53L3CX I2C device address: 0x52**

MSBit						LSBit	
0	1	0	1	0	0	1	R/W

All serial interface communications with the Time-of-Flight sensor must begin with a start condition. The VL53L3CX module acknowledges the receipt of a valid address by driving the SDA wire low. The state of the read/write bit (LSB of the address byte) is stored and the next byte of data, sampled from SDA, can be interpreted. During a write sequence, the second byte received provides a 16-bit index which points to one of the internal 8-bit registers.

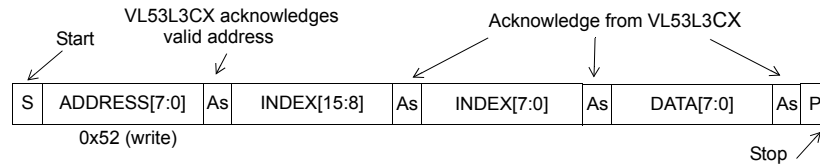
**Figure 11. VL53L3CX data format (write)**

As data are received by the slave, they are written bit by bit to a serial/parallel register. After each data byte has been received by the slave, an acknowledge is generated, the data are then stored in the internal register addressed by the current index

During a read message, the contents of the register addressed by the current index is read out in the byte following the device address byte. The contents of this register are parallel loaded into the serial/parallel register and clocked out of the device by the falling edge of SCL.

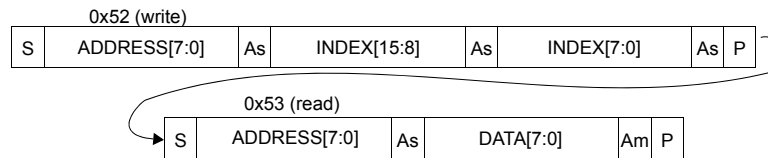
**Figure 12. VL53L3CX data format (read)**

At the end of each byte, in both read and write message sequences, an acknowledge is issued by the receiving device (that is, the VL53L3CX device for a write and the host for a read).

A message can only be terminated by the bus master, either by issuing a stop condition or by a negative acknowledge (that is, not pulling the SDA line low) after reading a complete byte during a read operation.

The interface also supports auto-increment indexing. After the first data byte has been transferred, the index is automatically incremented by 1. The master can therefore send data bytes continuously to the slave until the slave fails to provide an acknowledge or the master terminates the write communication with a stop condition. If the auto-increment feature is used the master does not have to send address indexes to accompany the data bytes.

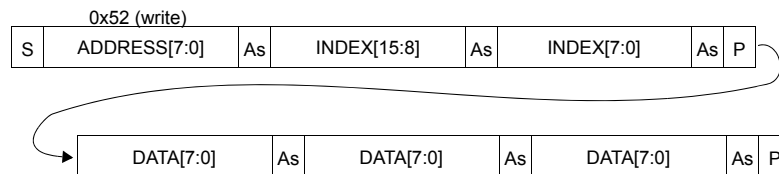
**Figure 13. VL53L3CX data format (sequential write)**

**Figure 14. VL53L3CX data format (sequential read)**

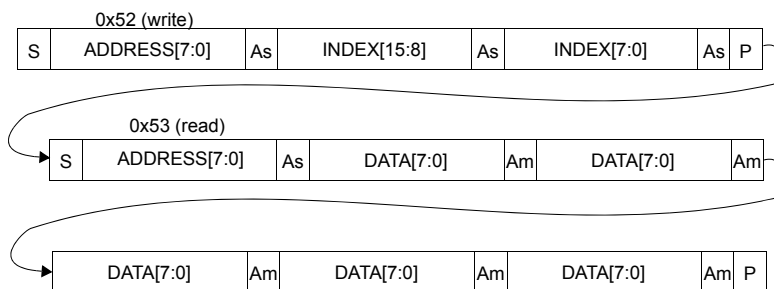

### 3.1 I2C interface - timing characteristics

Timing characteristics are shown in the tables below. Please refer to the figure below for an explanation of the parameters used.

Timings are given for all PVT conditions.

**Table 5. I2C interface - timing characteristics for Fast mode plus (1 MHz)**

Symbol	Parameter	Minimum	Typical	Maximum	Unit
$F_{I2C}$	Operating frequency	0	—	1000	kHz
$t_{LOW}$	Clock pulse width low	0.5		—	μs
$t_{HIGH}$	Clock pulse width high	0.26		—	
$t_{SP}$	Pulse width of spikes which are suppressed by the input filter	—		50	ns
$t_{BUF}$	Bus free time between transmissions	0.5		—	μs
$t_{HD.STA}$	Start hold time	0.26		—	
$t_{SU.STA}$	Start setup time	0.26		—	
$t_{HD.DAT}$	Data in hold time	0		0.9	ns
$t_{SU.DAT}$	Data in setup time	50		—	
$t_R$	SCL/SDA rise time	—		120	ns
$t_F$	SCL/SDA fall time	—		120	
$t_{SU.STO}$	Stop setup time	0.26		—	μs
$C_{i/o}$	Input/output capacitance (SDA)	—		10	pF
$C_{in}$	Input capacitance (SCL)	—		4	
$C_L$	Load capacitance	—		140	

**Table 6. I2C interface - timing characteristics for Fast mode (400 kHz)**

Symbol	Parameter	Minimum	Typical	Maximum	Unit
$F_{I2C}$	Operating frequency	0		400	kHz
$t_{LOW}$	Clock pulse width low	1.3		—	$\mu s$
$t_{HIGH}$	Clock pulse width high	0.6		—	
$t_{SP}$	Pulse width of spikes which are suppressed by the input filter	—		50	
$t_{BUF}$	Bus free time between transmissions	1.3		—	$\mu s$
$t_{HD.STA}$	Start hold time	0.26		—	
$t_{SU.STA}$	Start setup time	0.26	—	—	
$t_{HD.DAT}$	Data in hold time	0		0.9	
$t_{SU.DAT}$	Data in setup time	50		—	ns
$t_R$	SCL/SDA rise time	—		300	
$t_F$	SCL/SDA fall time	—		300	
$t_{SU.STO}$	Stop setup time	0.6		—	$\mu s$
$C_{i/o}$	Input/output capacitance (SDA)	—		10	pF
$C_{in}$	Input capacitance (SCL)	—		4	
$C_L$	Load capacitance	—	125	400	

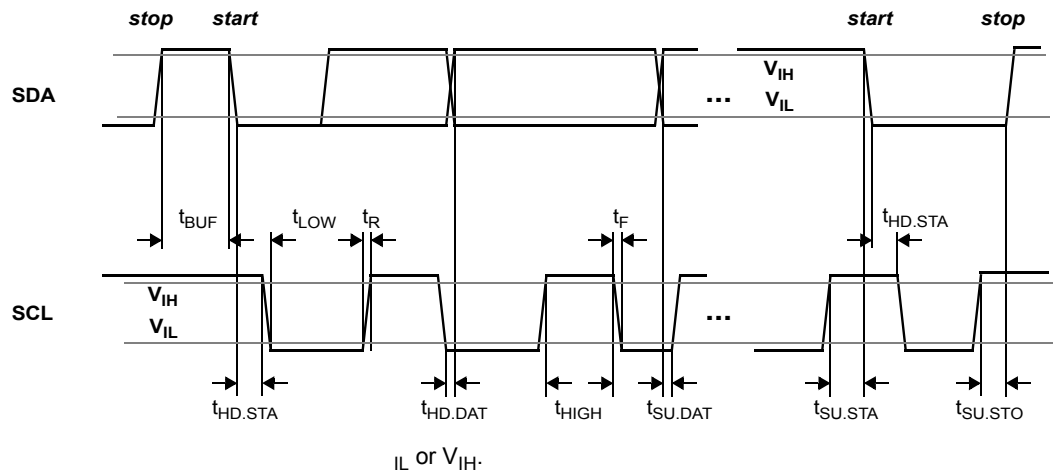
**Figure 15. I2C timing characteristics**

### 3.2 I2C interface - reference registers

The registers shown in the table below can be used to validate the user I2C interface.

**Table 7. Reference registers**

Register name	Index	Value
Model_ID	0x010F	0xEA
Module_Type	0x0110	0xAA

*Note:*

*The I2C read/writes can be 8, 16 or 32-bit. Multi-byte reads/writes are always addressed in ascending order with MSB first as shown in the table below. The customer must use the device software driver for easy and efficient ranging operations to match performance and accuracy criteria. Hence full register details are not exposed. The customer should refer to the device user manual.*

**Table 8. 32-bit register example**

Register address	Byte
Address	MSB
Address + 1	..
Address + 2	..
Address + 3	LSB

## 4 Electrical characteristics

### 4.1 Absolute maximum ratings

**Table 9. Absolute maximum ratings**

Parameter	Min.	Typ.	Max.	Unit
AVDD	-0.5	—	3.6	V
SCL, SDA, XSHUT, and GPIO1	-0.5	—	3.6	

**Note:** Stresses above those listed as "Absolute maximum ratings" may cause permanent damage to the device. This is a stress rating only and functional operation of the device at these or any other conditions above those indicated in the operational sections of the specification is not implied. Exposure to maximum rating conditions for extended periods may effect device reliability.

### 4.2 Recommended operating conditions

**Table 10. Recommended operating conditions**

There are no power supply sequencing requirements. The I/Os may be high, low or floating when AVDD is applied. The I/Os are internally failsafe with no diode connecting them to AVDD

Parameter	Min.	Typ.	Max.	Unit	
Voltage (AVDD)	2.6	2.8	3.5	V	
IO (IOVDD) <sup>(1)</sup>	Standard mode	1.6	1.8		1.9
	2V8 mode <sup>(2)</sup>	2.6	2.8		3.5
Ambient operating temperature range without damage <sup>(3)</sup>	-20		85	°C	

- XSHUT should be high level only when AVDD is on.*
- SDA, SCL, XSHUT and GPIO1 high levels have to be equal to AVDD in 2V8 mode.*
- performances described in the datasheet are given in 23 ° ambient temperature*

### 4.3 Electrostatic discharge

The device is compliant with electrostatic discharge (ESD) values presented in the table below.

**Table 11. ESD performances**

Parameter	Specification	Condition
Human body model	JS-001-2012	± 2 kV, 1500 Ohms, 100 pF
Charged device model	JESD22-C101	± 500 V



## 4.4 Current consumption

**Table 12. Power consumption at ambient temperature**

All current consumption values include silicon process variations. Temperature and voltage are nominal conditions (23 °C and 2v8). All values include AVDD and AVDDVCSEL.

Parameter	Min.	Typ.	Max.	Unit
HW STANDBY	3	5	7	μA
SW STANDBY (2V8 mode) <sup>(1)</sup>	4	6	9	
Active ranging average consumption (including VCSEL) <sup>(2) (3)</sup>		16	18	mA

1. In Standard mode (1v8), pullups have to be modified, then SW STANDBY consumption is increased by 0.6 μA.
2. Active ranging is an average value, measured using default driver settings. Ranging mode is with default settings.
3. Peak current (including VCSEL) can reach 40 mA.

## 4.5 Digital input and output

Symbol	Parameter	Min.	Typ.	Max.	Unit
<b>Interrupt pin (GPIO1)</b>					
V <sub>IL</sub>	Low level input voltage	—	—	0.3 IOVDD	V
V <sub>IH</sub>	High level input voltage	0.7 IOVDD		—	
V <sub>OL</sub>	Low level output voltage (I <sub>OUT</sub> = 4 mA)	—		0.4	
V <sub>OH</sub>	High level output voltage (I <sub>OUT</sub> = 4 mA)	IOVDD-0.4		—	
F <sub>GPIO</sub>	Operating frequency (C <sub>LOAD</sub> = 20 pF)	0		108	MHz
<b>I2C interface (SDA/SCL)</b>					
V <sub>IL</sub>	Low level input voltage	-0.5	—	0.6	V
V <sub>IH</sub>	High level input voltage	1.12		IOVDD+0.5	
V <sub>OL</sub>	Low level output voltage (I <sub>OUT</sub> = 4 mA)	—		0.4	
I <sub>IL/IH</sub>	Leakage current <sup>(1)</sup>	—		10	μA
	Leakage current <sup>(2)</sup>	—		0.15	

1. AVDD = 0 V
2. AVDD = 2.85 V; I/O voltage = 1.8 V

## 5 Ranging performances

### 5.1 Measurement conditions

In all measurement tables of the document, it is considered that:

1. The full field of view (FoV) is covered (typically 25 ° is covered)
2. Charts used as targets are: grey (17 % reflectance, N4.74 Munsell) and white (88 % reflectance N9.5 Munsell)
3. Nominal voltage (2.8 V) and temperature (23 °C)
4. The device is controlled through the driver using the default settings (refer to the user manual for driver settings description).
5. Indoor (no IR) means there is no contribution of light in the band 940 nm ± 30 nm. Outdoor overcast conditions means an illumination level of 0.7 W/m<sup>2</sup> back on the sensor, in the band 940 nm ± 30 nm.
6. No coverglass is present
7. Typical samples used

### 5.2 Minimum ranging distance

A target can be detected down to 10 mm.

### 5.3 Maximum ranging distance

The table below shows the ranging specification for the typical device bare module, without cover glass, at room temperature (23 °C), with nominal voltage (2.8 V), and full FoV covered.

**Table 13. Maximum ranging capabilities with 30 ms timing budget**

Target reflectance level, full FoV (reflectance %)	Indoor (detection rate %)	Outdoor overcast (detection rate %)
White target (88 %)	Typical: 310 cm @ 94 % min. Minimum: 310 cm @ 50 % min.	Typical: 100 cm @ 94 % min. Minimum: 110 cm @ 50 % min.
Light gray target (54 %)	Typical: 290 cm @ 94 % min. Minimum: 290 cm @ 50 % min.	Typical: 70 cm @ 94 % min. Minimum: 90 cm @ 50 % min.
Gray target (17 %)	Typical: 170 cm @ 94 % min. Minimum: 200 cm @ 50 % min.	Typical: 70 cm @ 94 % min. Minimum: 90 cm @ 50 % min.

*Note:*

*In the table above:*

- "Indoor" corresponds to no infrared
- "Outdoor overcast" corresponds to a parasitic noise of 10 kcps/SPAD for the device module. For reference, this corresponds to a 1.2 W/m<sup>2</sup> at 940 nm and is equivalent to 5 kLux daylight while ranging on a grey 17 % chart at 40 cm.
- Detection rate is the worst case percentage of measurements that return a valid measurement.
- The ranging distances reported are the ones reported by the driver by the parameter called RangeMilliMeter.

## 5.4 Ranging accuracy

Ranging accuracy is defined as follows:

$$RangingAccuracy = \frac{RangeMilliMeter - TargetDistance}{TargetDistance} \times 100$$

The ranging accuracy is a direct evaluation of the measurement, including offset errors and output noise.

At least 94 % of the ranging values are within the declared ranges. This quality indicator includes measure-to-measure and part-to-part dispersion.

**Table 14. Ranging accuracy with 30 ms timing budget**

Target reflectance level, full FoV	Distance (mm)	Indoor (no infrared)	Outdoor overcast
White target (88 %)	25-90	±10 mm	±10 mm
	90-110	±5 %	±9 %
	>110	±2.5 %	±7 %
Light gray target (54.5 %)	25-90	±9 mm	±9 mm
	90-110	±5 %	±7 %
	>110	±3 %	±8 %
Gray target (17 %)	25-90	±7 mm	±7 mm
	90-110	±5 %	±8 %
	>110	±5 %	±10 %

Measurement conditions:

- Offset correction made at 10 cm from sensor
- Indoor: no infrared
- Outdoor: eq. 5 kLux equivalent sunlight (10 kcps/SPAD)
- Nominal voltage (2v8) and temperature (23 °C)
- All distances are for a complete FoV covered
- Measurement is made on typical device bare modules

## 5.5 Ranging drift with temperature

When the temperature increases, the ranging value is affected by an offset of 1.3 mm per degree Celsius change.

This value is an offset and not a gain, and it does not depend on the target distance.

The VL53L3CX device embeds a feature that allows the temperature variation effect to be compensated, while ranging.

When the ranging is started, the self-calibration is performed once and this allows to remove the ranging drift.

In order to get the best accuracy performances, it is recommended to perform a self-calibration when temperature varies. This operation is realized calling in sequence the functions “stop” and “start”.

## 6 Outline drawings

ST delivers any of the two alternative dual source cap assemblies as detailed in the drawings below. Both versions are transparent for the customer, since the pad and substrate design are identical for both versions and have no impact on customer PCB design. Ranging performances, reflow, and technical parameters are identical for both module designs presented in the second figure below.

Figure 16. Outline drawing 1/4

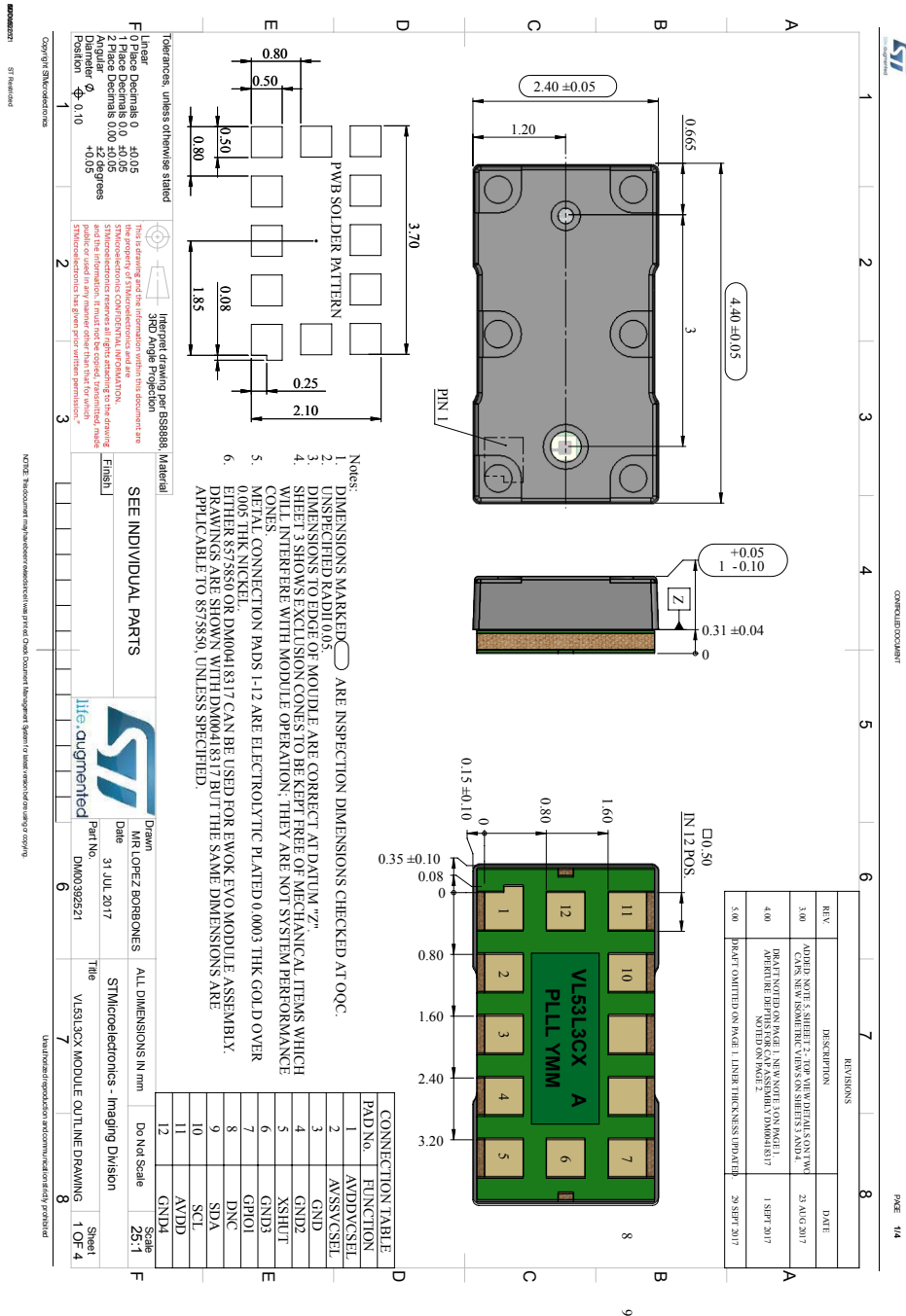

**Figure 17. Outline drawing 2/4**

Figure 18. Outline drawing 3/4



Tolerances, unless otherwise stated		Interpret drawing per BS8888		Material	
Linear	40.05	3RD Angle Projection	SEE INDIVIDUAL PARTS	Finish	Drawn
0 Place Decimals 0.0	40.05				
1 Place Decimals 0.0	40.05	3D Angle Projection			Date
2 Place Decimals 0.00	42.05	Interpret drawing per BS8888			31 JULY 2017
Angular	42.05	This is drawing and the information within this document are the property of STMicroelectronics and are not to be reproduced, stored in a retrieval system, or transmitted, in any form or by any means, electronic, mechanical, photocopying, recording, or by any information storage and retrieval system, without the prior written permission of STMicroelectronics.			Part No.
Position	40.05	STMicroelectronics reserves all rights pertaining to the drawing and the information. It must not be copied, transmitted, made public or used in any manner other than that for which STMicroelectronics has given prior written permission.			DM00392521
Position	40.10	3D Angle Projection			Title
Position	40.10	Interpret drawing per BS8888			VL53L3CX MODULE OUTLINE DRAWING
Copyright STMicroelectronics		3D Angle Projection			Sheet
STMicroelectronics		Interpret drawing per BS8888			3 OF 4
STMicroelectronics		Interpret drawing per BS8888			Scale
STMicroelectronics		Interpret drawing per BS8888			25:1
STMicroelectronics		Interpret drawing per BS8888			Do Not Scale
STMicroelectronics		Interpret drawing per BS8888			ALL DIMENSIONS IN mm
STMicroelectronics		Interpret drawing per BS8888			STMicroelectronics - Imaging Division
STMicroelectronics		Interpret drawing per BS8888			Unauthorized production and communication strictly prohibited
STMicroelectronics		Interpret drawing per BS8888			NOTE: This document may have been modified since it was printed. Check Document Management System for latest version before using or copying.

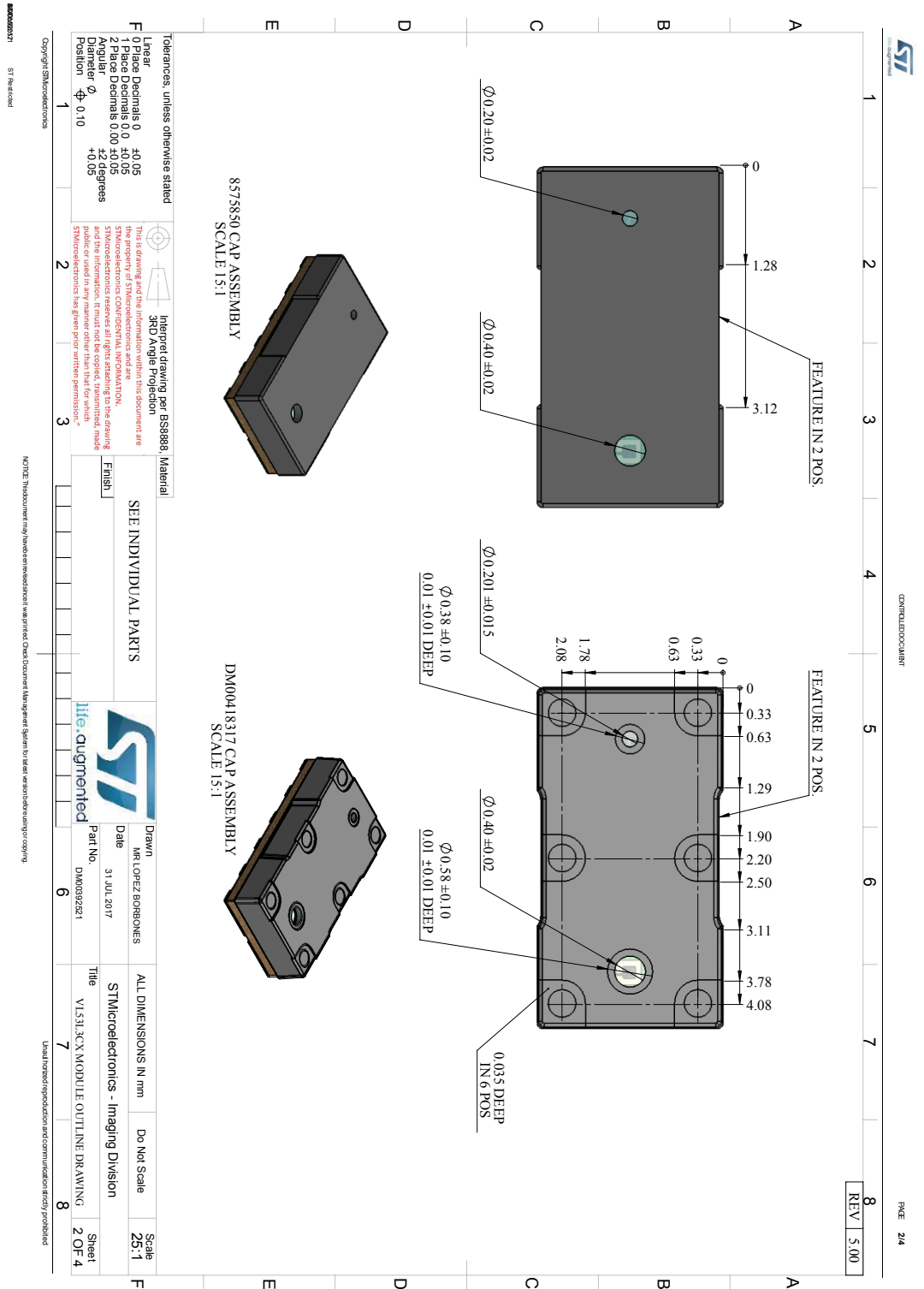
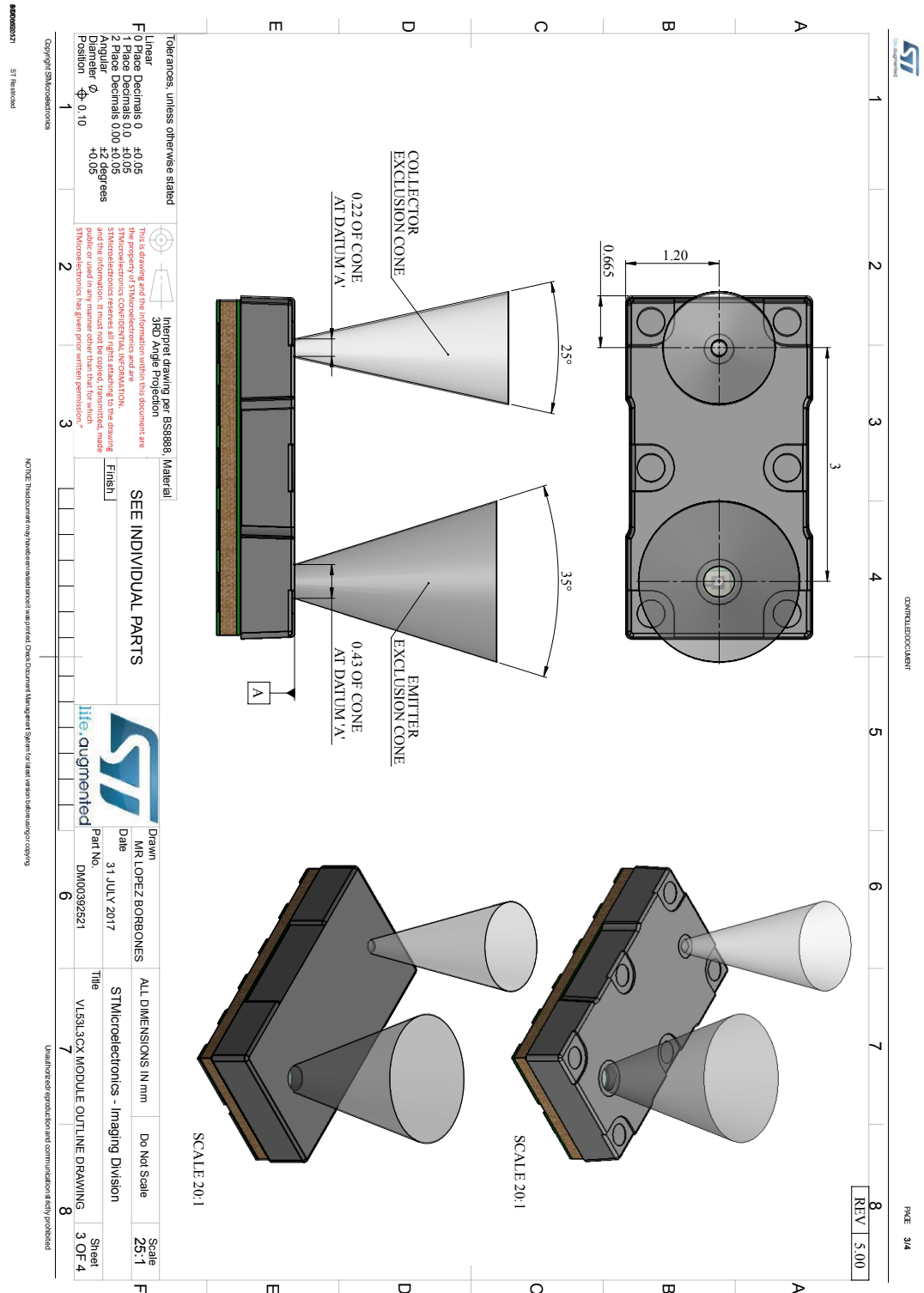

Figure 19. Outline drawing 4/4

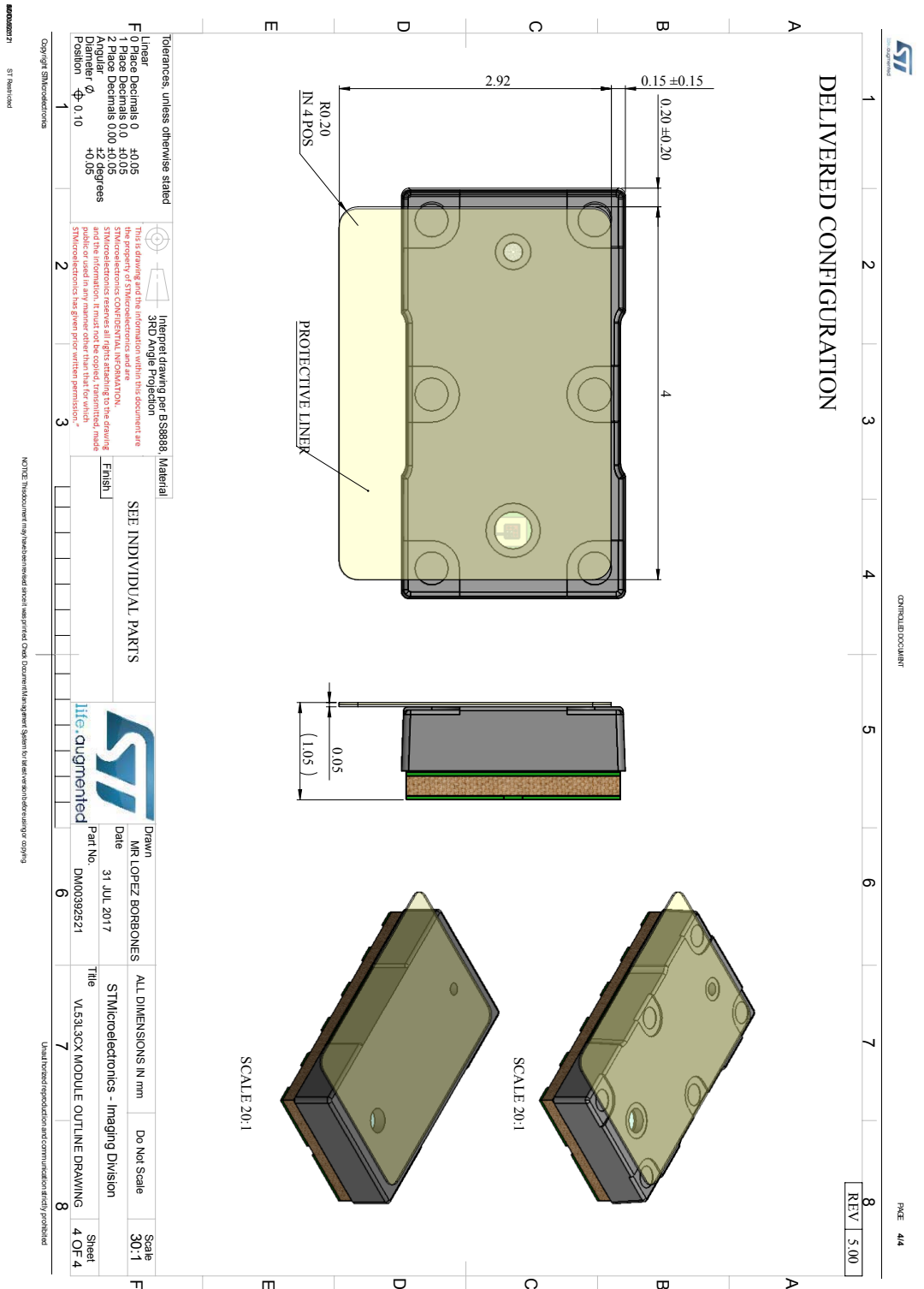

## 7 Laser safety considerations

The device contains a laser emitter and corresponding drive circuitry. The laser output is designed to remain within Class 1 laser safety limits under all reasonably foreseeable conditions including single faults in compliance with IEC 60825-1:2014 (third edition).

The laser output remains within Class 1 limits as long as STMicroelectronics' recommended device settings are used and the operating conditions specified are respected (particularly the maximum timing budget, as described in the product user manual).

The laser output power must not be increased by any means and no optics should be used with the intention of focusing the laser beam.

**Caution:** Use of controls or adjustments or performance of procedures other than those specified herein may result in hazardous radiation exposure.

Figure 20. Class 1 laser product label





## 8 Packaging and labeling

### 8.1 Product marking

A two-line product marking is applied on the backside of the module (i.e. on the substrate). The first line is the silicon product code, and the second line, the internal tracking code (see figure below).

Figure 21. Example of prototype marking

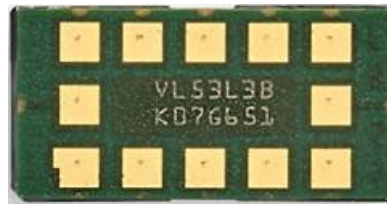

### 8.2 Inner box labeling

The labeling follows the ST standard packing acceptance specification.

The following information is written on the inner box label:

- Assembly site
- Sales type
- Quantity
- Trace code
- Marking
- Bulk ID number

### 8.3 Packing

At customer/subcontractor level, it is recommended to mount the device in a clean environment to avoid foreign material deposition.

To help avoid any foreign material contamination at phone assembly level the modules will be shipped in a tape and reel format, starting from production version (cut1.1). The tape is described in the [Figure 22. Tape outline drawing](#).

The packaging will be vacuum-sealed and include a desiccant.

## 8.4 Tape and outline drawing

**Figure 22. Tape outline drawing**

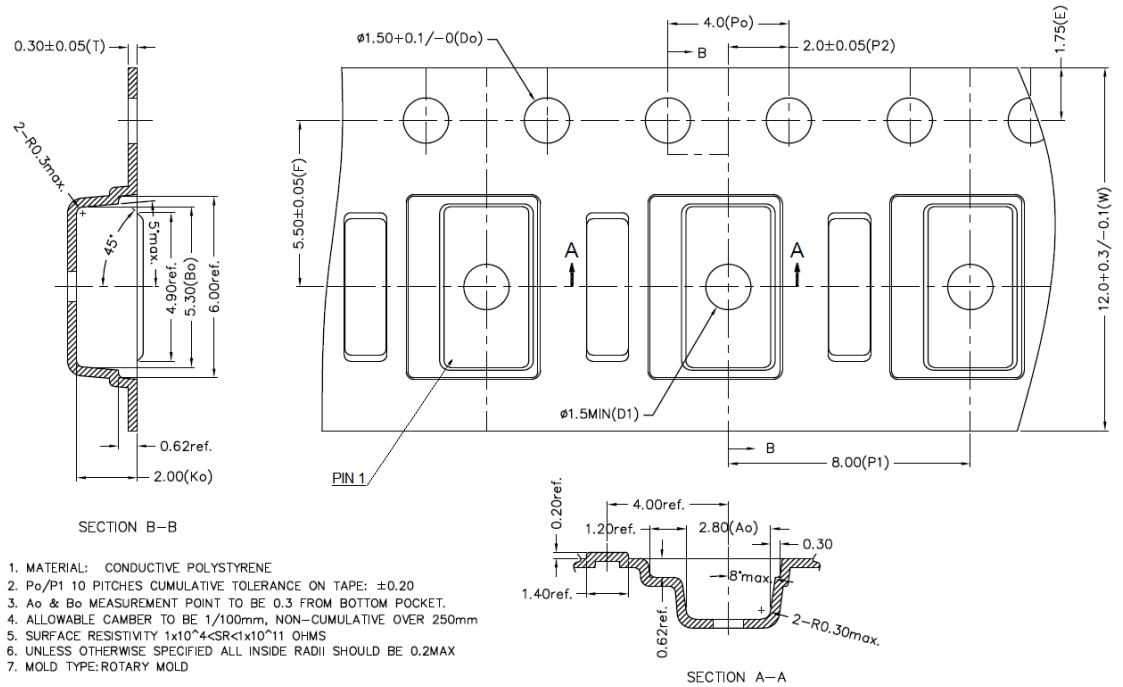

1. MATERIAL: CONDUCTIVE POLYSTYRENE
2.  $Po/P1$  10 PITCHES CUMULATIVE TOLERANCE ON TAPE:  $\pm 0.20$
3.  $Ao$  &  $Bo$  MEASUREMENT POINT TO BE 0.3 FROM BOTTOM POCKET.
4. ALLOWABLE CAMBER TO BE  $1/100mm$ , NON-CUMULATIVE OVER 250mm
5. SURFACE RESISTIVITY  $1 \times 10^4 < SR < 1 \times 10^{11}$  OHMS
6. UNLESS OTHERWISE SPECIFIED ALL INSIDE RADII SHOULD BE 0.2MAX
7. MOLD TYPE: ROTARY MOLD

## 8.5 Lead-free solder reflow process

The figure and table below show the recommended and maximum values for the solder profile.

Customers have to tune the reflow profile depending on the PCB, solder paste, and material used. We expect customers to follow the “recommended” reflow profile, which is specifically tuned for this specific device package.

If a customer must perform a reflow profile which is different from the “recommended” one (especially peak >240 °C), this new profile is qualified by the customer at their own risk. In any case, the profile has to be within the “maximum” profile limit described in the table below.

**Table 15. Recommended solder profile**

Parameters	Recommended	Maximum	Units
Minimum temperature ( $T_S$ min)	130	150	°C
Maximum temperature ( $T_S$ max)	200	200	°C
Time $t_S$ ( $T_S$ min to $T_S$ max)	90-110	60 - 120	s
Temperature ( $T_L$ )	217	217	°C
Time ( $t_L$ )	55-65	55 - 65	s
Ramp up	2	3	°C/s
Temperature ( $T_{p-10}$ )	—	250	°C
Time ( $t_{p-10}$ )	—	10	s
Ramp up	—	3	°C/s
Peak temperature ( $T_p$ )	240	260 max	°C
Time to peak	300	300	s
Ramp down (peak to $T_L$ )	-4	-6	°C/s

**Figure 23. Solder profile**

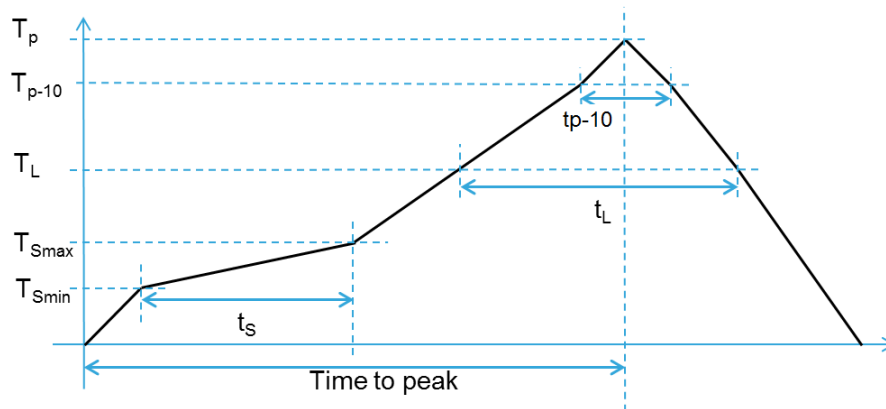

**Note:** The temperature mentioned in the above table is measured at the top of the device package.

**Note:** The component is limited to a maximum of three passes through this solder profile.

**Note:** As the device package is not sealed, only a dry re-flow process should be used (such as convection re-flow). Vapor phase re-flow is not suitable for this type of optical component.

**Note:** The device is an optical component and as such, it should be treated carefully. This would typically include using a ‘no-wash’ assembly process.

## 8.6 Handling and storage precautions

### 8.6.1 Shock precaution

Sensor modules house numerous internal components that are susceptible to shock damage. If a unit is subject to excessive shock, is dropped on the floor, or a tray/reel of units is dropped on the floor, it must be rejected, even if no apparent damage is visible.

### 8.6.2 Part handling

Handling must be done with non-marring ESD safe carbon, plastic, or teflon tweezers. Ranging modules are susceptible to damage or contamination. The customer is advised to use a clean assembly process after removing the tape from the parts, and until a protective cover glass is mounted.

The sensor apertures are protected by a liner. This liner must be removed to ensure proper performance in the final device. The liner should be removed at the latest possible step of the assembly process to help protect the sensor from foreign material during the assembly process.

### 8.6.3 Compression force

A maximum compressive load of 25 N should be applied on the module.

### 8.6.4 Moisture sensitivity level

Moisture sensitivity is level 3 (MSL) as described in IPC/JEDEC JSTD-020-C.

## 8.7 Storage temperature conditions

**Table 16. Recommended storage conditions**

Parameter	Min.	Typ.	Max.	Unit
Temperature (storage)	-40	23	85	°C

## **9** Package information

---

In order to meet environmental requirements, ST offers these devices in different grades of **ECOPACK** packages, depending on their level of environmental compliance. ECOPACK specifications, grade definitions and product status are available at: [www.st.com](http://www.st.com). ECOPACK is an ST trademark.

## 10 Ordering information

**Table 17. Order codes**

Order codes	Package	Packing	Minimum order quantity
VL53L3CXV0DH/1	Optical LGA12 with liner	Tape and reel	4500 pcs

## 11 Acronyms and abbreviations

Acronym/abbreviation	Definition
API	application programming interface
ESD	electrostatic discharge
FoV	field of view
FW	Firmware
I2C	inter-integrated circuit (serial bus)
NVM	non volatile memory
PDAF	phase-detection autofocus
SPAD	single photon avalanche diode
ToF	Time-of-Flight
VCSEL	vertical cavity surface emitting laser

## Revision history

**Table 18. Document revision history**

Date	Version	Changes
20-Dec-2019	1	Initial release
07-Feb-2020	2	Update "Application" and "Description" on first page and following sections: <a href="#">Section 5.2 Minimum ranging distance</a> , <a href="#">Section 5.3 Maximum ranging distance</a> , and <a href="#">Section 5.4 Ranging accuracy</a>
11-Mar-2021	3	Update <a href="#">Figure 21</a> . Example of prototype marking
13-Oct-2021	4	<a href="#">Section 3 Control interface</a> : replaced "camera module" with "Time-of-Flight" sensor.



## Contents

<b>1</b>	<b>Product overview</b>	<b>3</b>
1.1	Technical specification	3
1.2	System block diagram	3
1.3	Device pinout	4
1.4	Application schematic	5
<b>2</b>	<b>Functional description</b>	<b>6</b>
2.1	System functional description	6
2.2	State machine description	7
2.3	Customer manufacturing calibration flow	7
2.4	Device programming and control	7
2.5	Ranging mode description	8
2.6	Digital processing	8
2.7	Reading the results	8
2.8	Power sequence	9
2.8.1	Power up and boot sequence	9
2.9	Ranging sequence	10
2.10	Handshake management	10
<b>3</b>	<b>Control interface</b>	<b>11</b>
3.1	I2C interface - timing characteristics	13
3.2	I2C interface - reference registers	15
<b>4</b>	<b>Electrical characteristics</b>	<b>16</b>
4.1	Absolute maximum ratings	16
4.2	Recommended operating conditions	16
4.3	Electrostatic discharge	16
4.4	Current consumption	17
4.5	Digital input and output	17
<b>5</b>	<b>Ranging performances</b>	<b>18</b>
5.1	Measurement conditions	18
5.2	Minimum ranging distance	18

---

5.3	Maximum ranging distance .....	18
5.4	Ranging accuracy .....	19
5.5	Ranging drift with temperature.....	19
<b>6</b>	<b>Outline drawings .....</b>	<b>20</b>
<b>7</b>	<b>Laser safety considerations.....</b>	<b>24</b>
<b>8</b>	<b>Packaging and labeling .....</b>	<b>25</b>
8.1	Product marking .....	25
8.2	Inner box labeling .....	25
8.3	Packing.....	25
8.4	Tape and outline drawing .....	26
8.5	Lead-free solder reflow process .....	27
8.6	Handling and storage precautions .....	28
8.6.1	Shock precaution .....	28
8.6.2	Part handling .....	28
8.6.3	Compression force .....	28
8.6.4	Moisture sensitivity level .....	28
8.7	Storage temperature conditions .....	28
<b>9</b>	<b>Package information.....</b>	<b>29</b>
<b>10</b>	<b>Ordering information .....</b>	<b>30</b>
<b>11</b>	<b>Acronyms and abbreviations .....</b>	<b>31</b>
	<b>Revision history .....</b>	<b>32</b>
	<b>Contents .....</b>	<b>33</b>

**IMPORTANT NOTICE – PLEASE READ CAREFULLY**

STMicroelectronics NV and its subsidiaries (“ST”) reserve the right to make changes, corrections, enhancements, modifications, and improvements to ST products and/or to this document at any time without notice. Purchasers should obtain the latest relevant information on ST products before placing orders. ST products are sold pursuant to ST’s terms and conditions of sale in place at the time of order acknowledgement.

Purchasers are solely responsible for the choice, selection, and use of ST products and ST assumes no liability for application assistance or the design of Purchasers’ products.

No license, express or implied, to any intellectual property right is granted by ST herein.

Resale of ST products with provisions different from the information set forth herein shall void any warranty granted by ST for such product.

ST and the ST logo are trademarks of ST. For additional information about ST trademarks, please refer to [www.st.com/trademarks](http://www.st.com/trademarks). All other product or service names are the property of their respective owners.

Information in this document supersedes and replaces information previously supplied in any prior versions of this document.

© 2021 STMicroelectronics – All rights reserved

## X-ON Electronics

Largest Supplier of Electrical and Electronic Components

*Click to view similar products for [Proximity Sensors](#) category:*

*Click to view products by [STMicroelectronics](#) manufacturer:*

Other Similar products are found below :

[01.001.5653.1](#) [70.340.1028.0](#) [70.360.2428.0](#) [70.364.4828.0](#) [70.810.1053.0](#) [72.360.1628.0](#) [73.363.6428.0](#) [8027AL20NL2CPXX](#) [FYCC8E1-2](#)  
[9221350022](#) [922AA2W-A9P-L](#) [PLS2](#) [GL-12F-C2.5X10\(LOT3\)](#) [972AB2XM-A3N-L](#) [972AB3XM-A3P-L](#) [PS3251](#) [980659-1](#) [QT-12](#) [E2E2-](#)  
[X5M41-M4](#) [E2E-X14MD1-G](#) [E2E-X2D1-G](#) [E2EX2ME2N](#) [E2EX3D1SM1N](#) [E2E-X4MD1-G](#) [E2E-X5E1-5M-N](#) [E2E-X5Y2-N](#) [E2E-X7D1-](#)  
[M1J-T-0.3M-N](#) [E2FMX1R5D12M](#) [E2K-F10MC1](#) [5M](#) [EH-302](#) [EI3010TBOP](#) [EI5515NPAP](#) [MS605AU](#) [EP175-32000](#) [IFRM04N35B1/L](#)  
[IFRM04P1513/S35L](#) [IFRM06P1703/S35L](#) [IFRM08P1501/S35L](#) [IFRM12N17G3/L](#) [IFRM12P17G3/L](#) [IFRM12P3502/L](#) [IFRM12P37G1/S14L](#)  
[ILFK12E9189/I02](#) [ILFK12E9193/I02](#) [IMM2582C](#) [OISN-013](#) [25.161.3253.0](#) [25.332.0653.1](#) [25.352.0653.0](#) [25.352.0753.0](#)