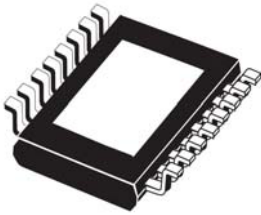


High-side driver with CurrentSense analog feedback for automotive applications



PowerSSO-16

Features

Max transient supply voltage	V_{CC}	40 V
Operating voltage range	V_{CC}	4 to 28 V
Typ. on-state resistance (per Ch)	R_{ON}	10.5 m Ω
Current limitation (typ)	I_{LIMH}	88 A
Standby current (max)	I_{STBY}	0.5 μ A
Minimum cranking supply voltage (V_{CC} decreasing)	$V_{USD_cranking}$	2.85 V



- AEC-Q100 qualified
- Extreme low voltage operation for deep cold cranking applications (compliant with LV124, revision 2013)
- General
 - Single channel smart high-side driver with CurrentSense analog feedback
 - Very low standby current
 - Compatible with 3 V and 5 V CMOS outputs
- CurrentSense diagnostic functions
 - Analog feedback of load current with high precision proportional current mirror
 - Overload and short to ground (power limitation) indication
 - Thermal shutdown indication
 - OFF-state open-load detection
 - Output short to V_{CC} detection
 - Sense enable/disable
- Protections
 - Undervoltage shutdown
 - Overvoltage clamp
 - Load current limitation
 - Self limiting of fast thermal transients
 - Configurable latch-off on overtemperature or power limitation
 - Loss of ground and loss of V_{CC}
 - Reverse battery with external components
 - Electrostatic discharge protection

Product status link

[VN7E010AJ](#)

Applications

- Automotive resistive, inductive and capacitive loads
- Protected supply for ADAS systems: radars and sensors
- Automotive headlamp

Description

The device is a single channel high-side driver manufactured with proprietary ST VIPower® M0-7 technology, in a PowerSSO-16 package. The device is designed to drive 12 V automotive grounded loads through a 3 V and 5 V CMOS-compatible interface, providing protection and diagnostics.

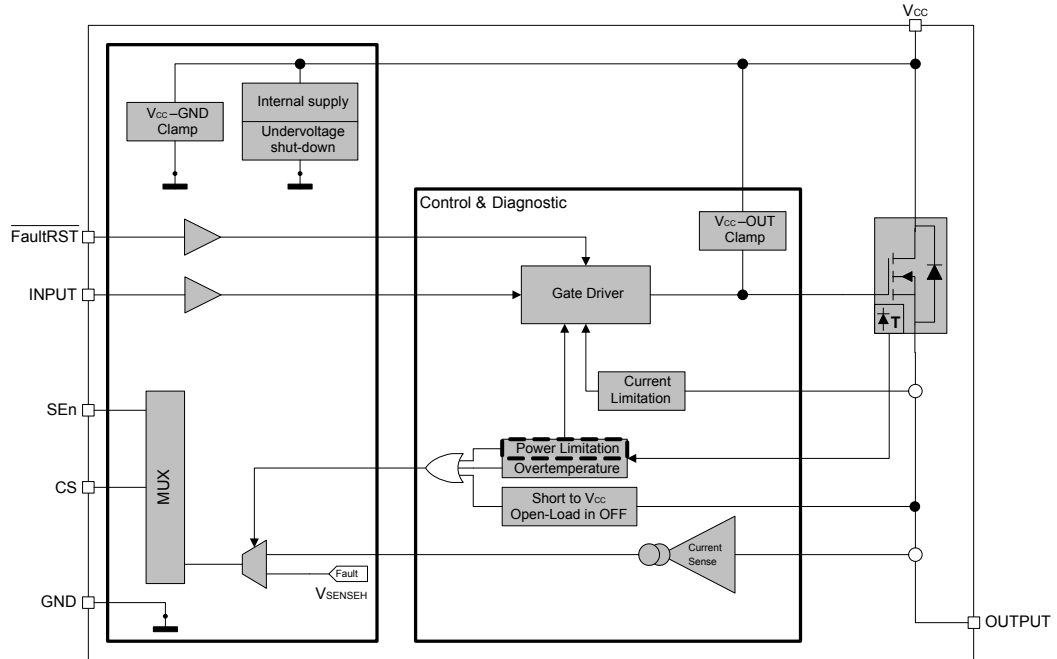
The device integrates advanced protective functions such as load current limitation, overload active management by power limitation and overtemperature shutdown with configurable latch-off.

A $\overline{\text{FaultRST}}$ pin unlatches the output in case of fault or disables the latch-off functionality.

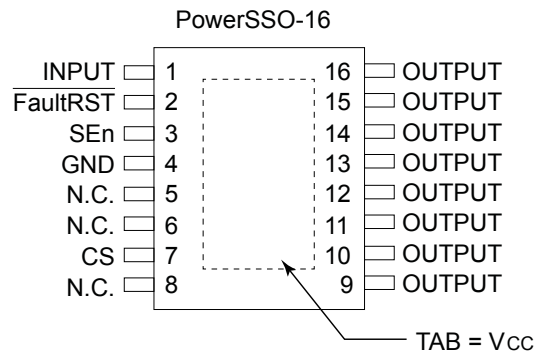
A current sense pin delivers high precision proportional load current sense in addition to the detection of overload and short circuit to ground, short to V_{CC} and OFF-state open-load.

A sense enable pin allows OFF-state diagnosis to be disabled during the module low-power mode as well as external sense resistor sharing among similar devices.

1 Block diagram and pin description

Figure 1. Block diagram

Table 1. Pin functions

Name	Function
V _{CC}	Battery connection.
OUTPUT	Power output; all the pins must be connected together.
GND	Ground connection; must be reverse battery protected by an external diode / resistor network.
INPUT	Voltage controlled input pin with hysteresis, compatible with 3 V and 5 V CMOS outputs; controls output switch state.
CS	Analog current sense output pin; delivers a current proportional to the selected load current.
SEn	Active high compatible with 3 V and 5 V CMOS outputs pin; enables the CS diagnostic pin.
FaultRST	Active low compatible with 3 V and 5 V CMOS outputs pin; it unlatches the output in case of fault - if kept low, sets the output to auto-restart mode.

Figure 2. Configuration diagram (top view)


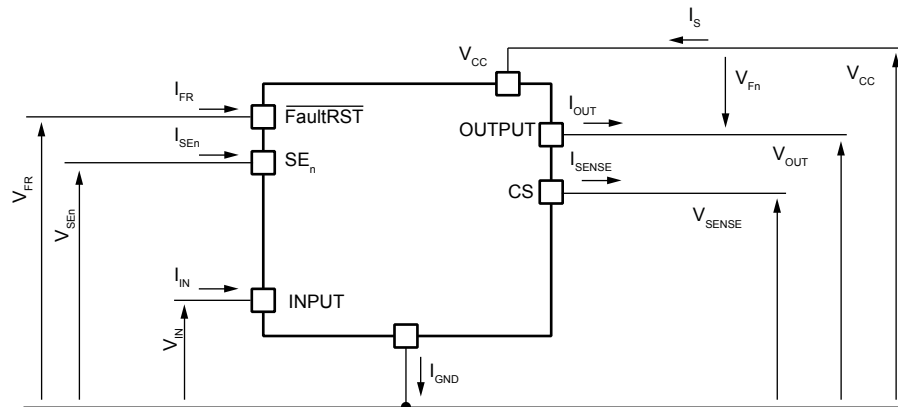
Note: Pins 9, 10, 11 and 12 are internally connected; Pins 13, 14, 15 and 16 are internally connected; all output pins must be connected together on PCB.

Table 2. Suggested connections for unused and not connected pins

Connection / pin	CS	N.C.	Output	Input	SEn, FaultRST
Floating	Not allowed	X ⁽¹⁾	X	X	X
To ground	Through 1 kΩ resistor	X	Not allowed	Through 15 kΩ resistor	Through 15 kΩ resistor

1. X: do not care.

2 Electrical specification

Figure 3. Current and voltage conventions


Note: $V_{FR} = V_{OUTn} - V_{CC}$ during reverse battery condition.

2.1 Absolute maximum ratings

Forcing the device to operate above absolute maximum ratings may cause permanent damage.

These are stress ratings only and operation of the device at these or any other conditions outside those indicated in the operating sections of this specification is not implied. Exposure to the conditions in table below for extended periods may affect device reliability.

Table 3. Absolute maximum ratings

Symbol	Parameter	Value	Unit
V_{CC}	DC supply voltage	38	V
$-V_{CC}$	Reverse DC supply voltage	0.3	
V_{CCPK}	Maximum transient supply voltage (ISO 16750-2:2010 Test B clamped to 40 V; $R_L = 4 \Omega$)	40	V
V_{CCJS}	Maximum jump start voltage for single pulse short circuit protection	28	V
$-I_{GND}$	DC reverse ground pin current	200	mA
I_{OUT}	OUTPUT DC output current	Internally limited	A
$-I_{OUT}$	Reverse DC output current	35	
I_{IN}	INPUT DC input current	-1 to 10	mA
I_{SEn}	SEn DC input current		
I_{FR}	FaultRST DC input current		
I_{SENSE}	CS pin DC output current ($V_{GND} = V_{CC}$ and $V_{SENSE} < 0$ V)	10	mA
	CS pin DC output current in reverse ($V_{CC} < 0$ V)	-20	
E_{MAX}	Maximum switching energy (single pulse) ($T_{DEMAG} = 0.4$ ms; $T_{jstart} = 150$ °C)	118	mJ

Symbol	Parameter	Value	Unit
V _{ESD}	Electrostatic discharge (JEDEC 22A-114F)		
	INPUT	4000	V
	CS, SEn	2000	
	$\overline{\text{FaultRST}}$	4000	
	OUTPUT	4000	
	V _{CC}	4000	
V _{ESD}	Charge device model (CDM-AEC-Q100-011)	750	V
T _j	Junction operating temperature	-40 to 150	°C
T _{stg}	Storage temperature	-55 to 150	

2.2 Thermal data

Table 4. Thermal data

Symbol	Parameter	Typ. value	Unit
R _{thj-board}	Thermal resistance junction-board (JEDEC JESD 51-5 / 51-8) ⁽¹⁾	4.2	°C/W
R _{thj-amb}	Thermal resistance junction-ambient (JEDEC JESD 51-5) ⁽²⁾	55	
R _{thj-amb}	Thermal resistance junction-ambient (JEDEC JESD 51-7) ⁽¹⁾	21.4	
R _{thj-top}	Thermal resistance junction-top (JEDEC JESD 51-7) ⁽¹⁾	12.1	

1. Device mounted on four-layer 2s2p PCB

2. Device mounted on two-layer 2s0p PCB with 2 cm² heatsink copper trace

2.3 Main electrical characteristics

7 V < V_{CC} < 28 V; -40°C < T_j < 150°C, unless otherwise specified.

All typical values refer to V_{CC} = 13 V; T_j = 25°C, unless otherwise specified.

Table 5. Electrical characteristics during cranking

Symbol	Parameter	Test conditions	Min.	Typ.	Max.	Unit
V _{USD_Cranking}	Minimum cranking supply voltage (V _{CC} decreasing)				2.85	V
R _{ON}	On-state resistance	I _{OUT} = 1 A; V _{CC} = 2.85 V; V _{CC} decreasing			31.5	mΩ
T _{TSD} ⁽¹⁾	Shutdown temperature (V _{CC} decreasing)	V _{CC} = 2.85 V	140			°C

1. Parameter guaranteed by design and characterization; not subject to production test

Table 6. Power section

Symbol	Parameter	Test conditions	Min.	Typ.	Max.	Unit
V _{CC}	Operating supply voltage		4	13	28	V
V _{USD}	Undervoltage shutdown				2.85	V
V _{USDReset}	Undervoltage shutdown reset				5	V

Symbol	Parameter	Test conditions	Min.	Typ.	Max.	Unit
$V_{USDhyst}$	Undervoltage shutdown hysteresis			0.3		V
R_{ON}	On-state resistance	$I_{OUT} = 5\text{ A}; T_j = 25^\circ\text{C}$		10.5		m Ω
		$I_{OUT} = 5\text{ A}; T_j = 150^\circ\text{C}$			22.5	
		$I_{OUT} = 5\text{ A}; V_{CC} = 4\text{ V}; T_j = 25^\circ\text{C}^{(1)}$			17	
V_{clamp}	Clamp voltage	$I_S = 20\text{ mA}; 25^\circ\text{C} < T_j < 150^\circ\text{C}$	41	46	52	V
		$I_S = 20\text{ mA}; T_j = -40^\circ\text{C}$	38			V
I_{STBY}	Supply current in standby at $V_{CC} = 13\text{ V}^{(2)}$	$V_{CC} = 13\text{ V};$ $V_{IN} = V_{OUT} = V_{FR} = V_{SEn} = 0\text{ V};$ $T_j = 25^\circ\text{C}$			0.5	μA
		$V_{CC} = 13\text{ V};$ $V_{IN} = V_{OUT} = V_{FR} = V_{SEn} = 0\text{ V};$ $T_j = 85^\circ\text{C}^{(3)}$			0.5	
		$V_{CC} = 13\text{ V};$ $V_{IN} = V_{OUT} = V_{FR} = V_{SEn} = 0\text{ V};$ $T_j = 125^\circ\text{C}$			3	
t_{D_STBY}	Standby mode blanking time	$V_{CC} = 13\text{ V};$ $V_{IN} = 5; V_{SEn} = V_{FR} = 0\text{ V}; I_{OUT} = 0\text{ A}$	60	300	550	μs
$I_{S(ON)}$	Supply current	$V_{CC} = 13\text{ V}; V_{SEn} = V_{FR} = 0\text{ V};$ $V_{IN} = 5\text{ V}; I_{OUT} = 0\text{ A}$		3	5	mA
$I_{GND(ON)}$	Control stage current consumption in ON state. All channels active.	$V_{CC} = 13\text{ V}; V_{SEn} = 5\text{ V}; V_{FR} = 0\text{ V};$ $V_{IN} = 5\text{ V}; I_{OUT} = 5\text{ A}$			6	mA
$I_{L(off)}^{(2)}$	Off-state output current at $V_{CC} = 13\text{ V}$	$V_{IN} = V_{OUT} = 0\text{ V}; V_{CC} = 13\text{ V};$ $T_j = 25^\circ\text{C}$	0	0.01	0.5	μA
		$V_{IN} = V_{OUT} = 0\text{ V}; V_{CC} = 13\text{ V};$ $T_j = 125^\circ\text{C}$	0		3	
V_F	Output - V_{CC} diode voltage at $T_j = 150^\circ\text{C}$	$I_{OUT} = -5\text{ A}; T_j = 150^\circ\text{C}$			0.7	V

1. Parameter guaranteed only at $V_{CC} = 4\text{ V}$ and $T_j = 25^\circ\text{C}$

2. PowerMOS leakage included

3. Parameter specified by design; not subject to production test.

Table 7. Switching

$V_{CC} = 13\text{ V}; -40^\circ\text{C} < T_j < 150^\circ\text{C}, \text{ unless otherwise specified}$						
Symbol	Parameter	Test conditions	Min.	Typ.	Max.	Unit
$t_{d(on)}^{(1)}$	Turn-on delay time at $T_j = 25^\circ\text{C}$	$R_L = 2.6\ \Omega$	10	50	120	μs
$t_{d(off)}^{(1)}$	Turn-off delay time at $T_j = 25^\circ\text{C}$		10	50	100	
$(dV_{OUT}/dt)_{on}^{(1)}$	Turn-on voltage slope at $T_j = 25^\circ\text{C}$	$R_L = 2.6\ \Omega$	0.1	0.25	0.7	V/ μs
$(dV_{OUT}/dt)_{off}^{(1)}$	Turn-off voltage slope at $T_j = 25^\circ\text{C}$		0.1	0.3	0.7	
W_{ON}	Switching energy losses at turn-on (t_{won})	$R_L = 2.6\ \Omega$	—	0.8	1.2 ⁽²⁾	mJ

$V_{CC} = 13\text{ V}; -40^{\circ}\text{C} < T_J < 150^{\circ}\text{C}$, unless otherwise specified						
Symbol	Parameter	Test conditions	Min.	Typ.	Max.	Unit
W_{OFF}	Switching energy losses at turn-off (t_{woff})	$R_L = 2.6\ \Omega$	—	0.7	1.1 ⁽²⁾	mJ
t_{SKEW}	Differential pulse skew ($t_{PHL} - t_{PLH}$)	$R_L = 2.6\ \Omega$	-50	0	+50	μs

1. See [Figure 6. Switching time and pulse skew](#)
2. Parameter guaranteed by design and characterization; not subject to production test.

Table 8. Logic inputs

$7\text{ V} < V_{CC} < 28\text{ V}; -40^{\circ}\text{C} < T_J < 150^{\circ}\text{C}$						
Symbol	Parameter	Test conditions	Min.	Typ.	Max.	Unit
INPUT characteristics						
V_{IL}	Input low level voltage				0.9	V
I_{IL}	Low level input current	$V_{IN} = 0.9\text{ V}$	1			μA
V_{IH}	Input high level voltage		2.1			V
I_{IH}	High level input current	$V_{IN} = 2.1\text{ V}$			10	μA
$V_{I(hyst)}$	Input hysteresis voltage		0.2			V
V_{ICL}	Input clamp voltage	$I_{IN} = 1\text{ mA}$	5.3		7.2	V
		$I_{IN} = -1\text{ mA}$		-0.7		
FaultRST characteristics						
V_{FRL}	Input low level voltage				0.9	V
I_{FRL}	Low level input current	$V_{IN} = 0.9\text{ V}$	1			μA
V_{FRH}	Input high level voltage		2.1			V
I_{FRH}	High level input current	$V_{IN} = 2.1\text{ V}$			10	μA
$V_{FR(hyst)}$	Input hysteresis voltage		0.2			V
V_{FRCL}	Input clamp voltage	$I_{IN} = 1\text{ mA}$	5.3		7.5	V
		$I_{IN} = -1\text{ mA}$		-0.7		
SEn characteristics ($7\text{ V} < V_{CC} < 18\text{ V}$)						
V_{SEnL}	Input low level voltage				0.9	V
I_{SEnL}	Low level input current	$V_{IN} = 0.9\text{ V}$	1			μA
V_{SEnH}	Input high level voltage		2.1			V
I_{SEnH}	High level input current	$V_{IN} = 2.1\text{ V}$			10	μA
$V_{SEn(hyst)}$	Input hysteresis voltage		0.2			V
V_{SEnCL}	Input clamp voltage	$I_{IN} = 1\text{ mA}$	5.3		7.2	V
		$I_{IN} = -1\text{ mA}$		-0.7		

Table 9. Protections

7 V < V _{CC} < 18 V; -40°C < T _j < 150°C						
Symbol	Parameter	Test conditions	Min.	Typ.	Max.	Unit
I _{LIMH}	DC short circuit current	V _{CC} = 13 V	63	88	126	A
		4 V < V _{CC} < 18 V ⁽¹⁾				
I _{LIML}	Short circuit current during thermal cycling	V _{CC} = 13 V; T _R < T _j < T _{TSD}		29		
T _{TSD}	Shutdown temperature		150	175	200	°C
T _R	Reset temperature ⁽¹⁾		T _{RS} + 1	T _{RS} + 7		
T _{RS}	Thermal reset of fault diagnostic indication	V _{FR} = 0 V; V _{SEn} = 5 V	135			
T _{HYST}	Thermal hysteresis (T _{TSD} - T _R) ⁽¹⁾			7		
ΔT _{J_SD}	Dynamic temperature	T _j = -40°C; V _{CC} = 13 V		60		K
t _{LATCH_RST}	Fault reset time for output unlatch ⁽¹⁾	V _{FR} = 5 V to 0 V; V _{SEn} = 5 V; - E.g. Ch ₀ V _{IN} = 5 V	3	10	20	μs
V _{DEMAG}	Turn-off output voltage clamp	I _{OUT} = 2 A; L = 6 mH; T _j = -40°C	V _{CC} - 38			V
		I _{OUT} = 2 A; L = 6 mH; T _j = 25°C to 150°C	V _{CC} - 41	V _{CC} - 46	V _{CC} - 52	V

1. Parameter guaranteed by design and characterization; not subject to production test.

Table 10. CurrentSense

7 V < V _{CC} < 18 V; -40°C < T _j < 150°C						
Symbol	Parameter	Test conditions	Min.	Typ.	Max.	Unit
V _{SENSE_CL}	CurrentSense clamp voltage	V _{SEn} = 0 V; I _{SENSE} = 1 mA	-17		-12	V
		V _{SEn} = 0 V; I _{SENSE} = -1 mA		7		
CurrentSense characteristics						
K ₀	I _{OUT} /I _{SENSE}	I _{OUT} = 0.1 A; V _{SENSE} = 0.5 V; V _{SEn} = 5 V	-40%	5000	+40%	
dK ₀ /K ₀ ^{(1) (2)}	CurrentSense ratio drift		-20		20	%
K ₁	I _{OUT} /I _{SENSE}	I _{OUT} = 0.25 A; V _{SENSE} = 0.5 V; V _{SEn} = 5 V	-25%	5000	25%	
dK ₁ /K ₁ ^{(1) (2)}	CurrentSense ratio drift		-15		15	%
K ₂	I _{OUT} /I _{SENSE}	I _{OUT} = 6 A; V _{SENSE} = 4 V; V _{SEn} = 5 V	-7%	5000	7%	
dK ₂ /K ₂ ^{(1) (2)}	CurrentSense ratio drift		-6		6	%
K ₃	I _{OUT} /I _{SENSE}	I _{OUT} = 18 A; V _{SENSE} = 4 V; V _{SEn} = 5 V	-7%	5000	7%	
dK ₃ /K ₃ ^{(1) (2)}	CurrentSense ratio drift		-6		6	%
I _{SENSE_OL}	CS current for OL detection	I _{OUT} = 0.01 A; V _{SENSE} = 0.5 V; V _{SEn} = 5 V			11.5	μA

7 V < V _{CC} < 18 V; -40°C < T _j < 150°C						
Symbol	Parameter	Test conditions	Min.	Typ.	Max.	Unit
I _{SENSE0}	CurrentSense leakage current	CS disabled: V _{SEn} = 0 V	0		0.5	μA
		CS disabled: -1 V < V _{SENSE} < 5 V ⁽¹⁾	-0.5		0.5	
		CS enabled: V _{SEn} = 5 V; all channel ON; I _{OUT} = 0 A; diagnostic selected; V _{IN} = 5 V; I _{OUT} = 0 A	0		10	
		CS enabled: V _{SEn} = 5 V; channel OFF; diagnostic selected; V _{IN} = 0 V	0		2	
V _{OUT_MSD} ⁽¹⁾	Output voltage for CurrentSense shutdown	V _{IN} = 5 V; V _{SEn} = 5 V; R _{SENSE} = 2.7 kΩ; I _{OUT} = 5 A		5		V
V _{SENSE_SAT}	CurrentSense saturation voltage	V _{CC} = 7 V; R _{SENSE} = 2.7 kΩ; V _{SEn} = 5 V; V _{IN} = 5 V; I _{OUT} = 18 A; T _j = -40°C	4.8			V
I _{SENSE_SAT} ⁽¹⁾	CS saturation current	V _{CC} = 7 V; V _{SENSE} = 4 V; V _{IN} = 5 V; V _{SEn} = 5 V; T _j = 150°C	4			mA
I _{OUT_SAT} ⁽¹⁾	Output saturation current	V _{CC} = 7 V; V _{SENSE} = 4 V; V _{IN} = 5 V; V _{SEn} = 5 V; T _j = 150°C	22			A
OFF-state diagnostic						
V _{OL}	OFF-state open-load voltage detection threshold	V _{IN} = 0 V; V _{SEn} = 0 V	2	3	4	V
I _{L(off2)} ⁽³⁾	OFF-state output sink current	V _{IN} = 0 V; V _{OUT} = V _{OL} ; T _j = -40°C to 125°C	-100		-15	μA
t _{DSTKON}	OFF-state diagnostic delay time from falling edge of INPUT (see Figure 8. T_{DSTKON})	V _{IN} = 5 V to 0 V; V _{SEn} = 5 V; I _{OUT} = 0 A; V _{OUT} = 4 V	100	350	700	μs
t _{D_OL_V}	Settling time for valid OFF-state open load diagnostic indication from rising edge of SEn	V _{IN} = 0 V; V _{FR} = 0 V; V _{OUT} = 4 V; V _{SEn} = 0 V to 5 V			60	μs
t _{D_VOL}	OFF-state diagnostic delay time from rising edge of V _{OUT}	V _{IN} = 0 V; V _{SEn} = 5 V; V _{OUT} = 0 V to 4 V		5	30	μs
Fault diagnostic feedback (see Table 11. Truth table)						
V _{SENSEH}	CurrentSense output voltage in fault condition	V _{CC} = 13 V; V _{IN} = 0 V; V _{SEn} = 5 V; I _{OUT} = 0 A; V _{OUT} = 4 V; R _{SENSE} = 1 kΩ	5		6.6	V
I _{SENSEH}	CurrentSense output current in fault condition	V _{CC} = 13 V; V _{SENSE} = 5 V	7	20	30	mA
CurrentSense timings (current sense mode - see Figure 7. CurrentSense timings (current sense mode)) ⁽⁴⁾						
t _{DSENSE1H}	Current sense settling time from rising edge of SEn	V _{IN} = 5 V; V _{SEn} = 0 V to 5 V; R _{SENSE} = 1 kΩ; R _L = 2.6 Ω			60	μs

7 V < V _{CC} < 18 V; -40°C < T _j < 150°C						
Symbol	Parameter	Test conditions	Min.	Typ.	Max.	Unit
t _{DSENSE1L}	Current sense disable delay time from falling edge of SEn	V _{IN} = 5 V; V _{SEn} = 5 V to 0 V; R _{SENSE} = 1 kΩ; R _L = 2.6 Ω		5	20	μs
t _{DSENSE2H}	Current sense settling time from rising edge of INPUT	V _{IN} = 0 V to 5 V; V _{SEn} = 5 V; R _{SENSE} = 1 kΩ; R _L = 2.6 Ω		100	250	μs
Δt _{DSENSE2H}	Current sense settling time from rising edge of I _{OUT} (dynamic response to a step change of I _{OUT})	V _{IN} = 5 V; V _{SEn} = 5 V; R _{SENSE} = 1 kΩ; I _{SENSE} = 90 % of I _{SENSEMAX} ; R _L = 2.6 Ω			100	μs
t _{DSENSE2L}	Current sense turn-off delay time from falling edge of INPUT	V _{IN} = 5 V to 0 V; V _{SEn} = 5 V; R _{SENSE} = 1 kΩ; R _L = 2.6 Ω		50	250	μs

1. Parameter specified by design; not subject to production test.
2. All values refer to V_{CC} = 13 V; T_j = 25°C, unless otherwise specified.
3. Parameter granted at -40 °C < T_j < 125 °C
4. Transition delay are measured up to +/- 10% of final conditions.

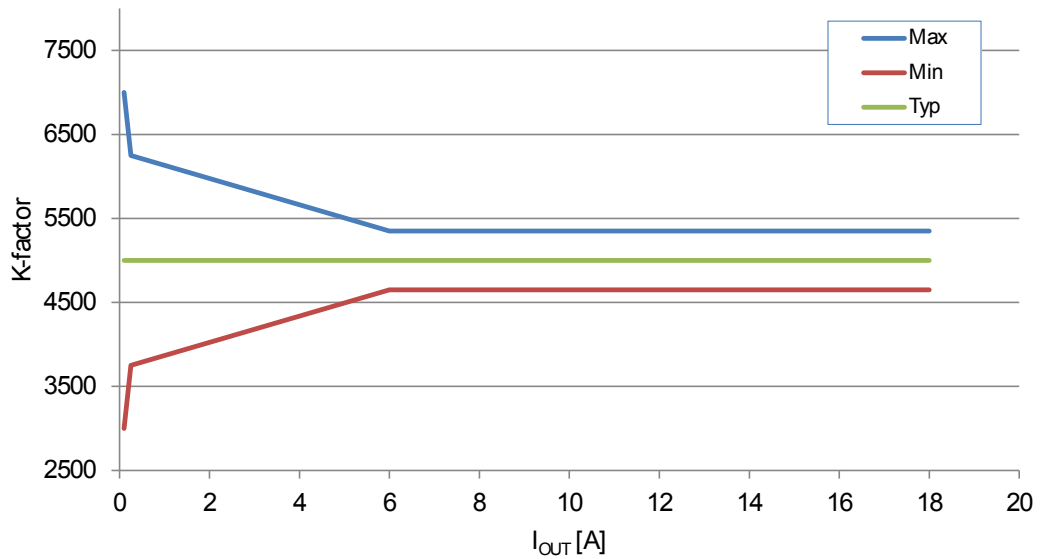
Figure 4. I_{OUT}/I_{SENSE} versus I_{OUT}


Figure 5. Current sense accuracy versus I_{OUT}

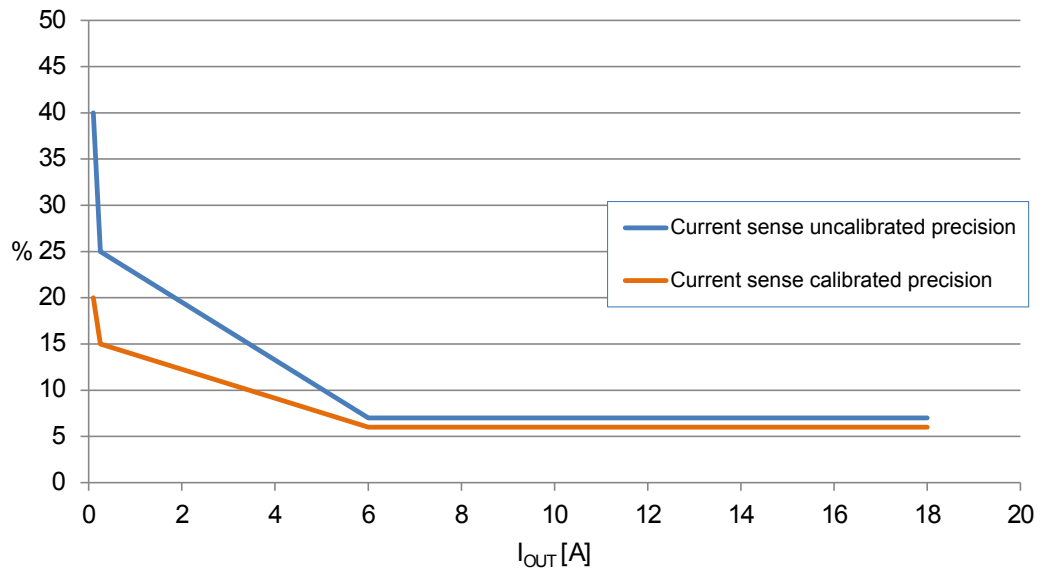


Figure 6. Switching time and pulse skew

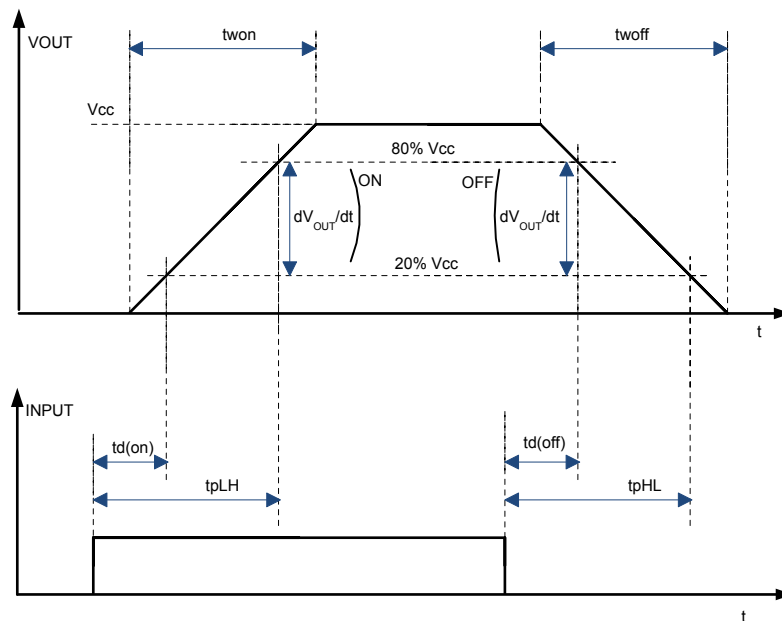
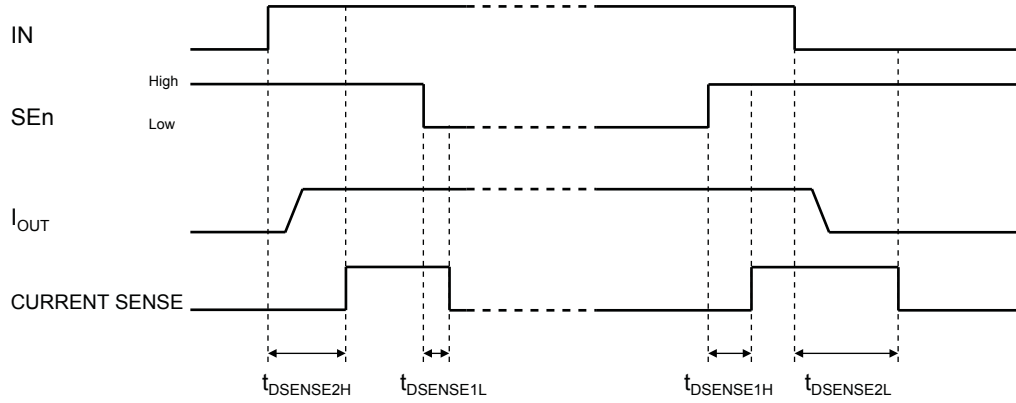
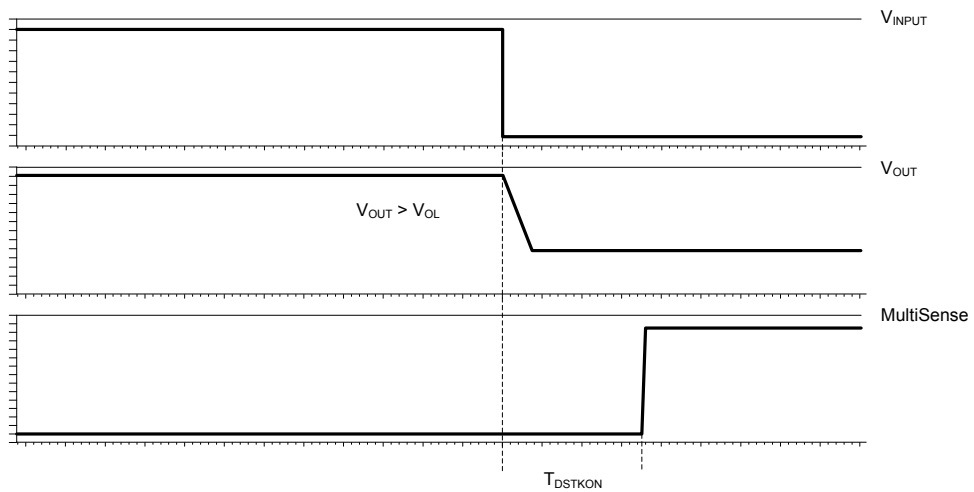


Figure 7. CurrentSense timings (current sense mode)


GAPG1003141014CFT

Figure 8. T_{DSTKON}


GAPG2609141140CFT

Table 11. Truth table

Mode	Conditions	IN _x	FR	SEn	OUT _x	CurrentSense	Comments
Standby	All logic inputs low	L	L	L	L	Hi-Z	Low quiescent current consumption
Normal	Nominal load connected; $T_j < 150\text{ }^\circ\text{C}$	L	X	See (1)	L	See (1)	Outputs configured for auto-restart
		H	L		H		
		H	H		H		
Overload	Overload or short to GND causing: $T_j > T_{TSD}$ or $\Delta T_j > \Delta T_{j_SD}$	L	X	See (1)	L	See (1)	Output cycles with temperature hysteresis
		H	L		H		
		H	H		L		

Mode	Conditions	IN _x	FR	SEn	OUT _x	CurrentSense	Comments
Undervoltage	V _{CC} < V _{USD} (falling)	X	X	X	L L	Hi-Z Hi-Z	Re-start when V _{CC} > V _{USD} + V _{USDhyst} (rising)
OFF-state diagnostics	Short to V _{CC}	L	X	See ⁽¹⁾	H	See ⁽¹⁾	
	Open-load	L	X		H		External pull-up
Negative output voltage	Inductive loads turn-off	L	X	See ⁽¹⁾	< 0 V	See ⁽¹⁾	

1. Refer to Table 12. CurrentSense multiplexer addressing

Table 12. CurrentSense multiplexer addressing

SEn	MUX channel	CurrentSense output			
		Normal mode	Overload	OFF-state diag.	Negative output
L		Hi-Z			
H	output diagnostic	I _{SENSE} = 1/K * I _{OUT}	V _{SENSE} = V _{SENSEH}	V _{SENSE} = V _{SENSEH}	Hi-Z

Note:

If the output channel for the selected MUX channel is latched off while the relevant input is low, the CS pin delivers feedback according to OFF-State diagnostic.

Example 1: FR = 1; IN = 0; OUT = L (latched); MUX channel = channel 0 diagnostic; CS = 0.

Example 2: FR = 1; IN = 0; OUT = latched, V_{OUT} > V_{OL}; MUX channel = channel 0 diagnostic; CS = V_{SENSEH}

2.4 Waveforms

Figure 9. Latch functionality: behavior in hard short-circuit condition (T_{AMB} << T_{TSD})

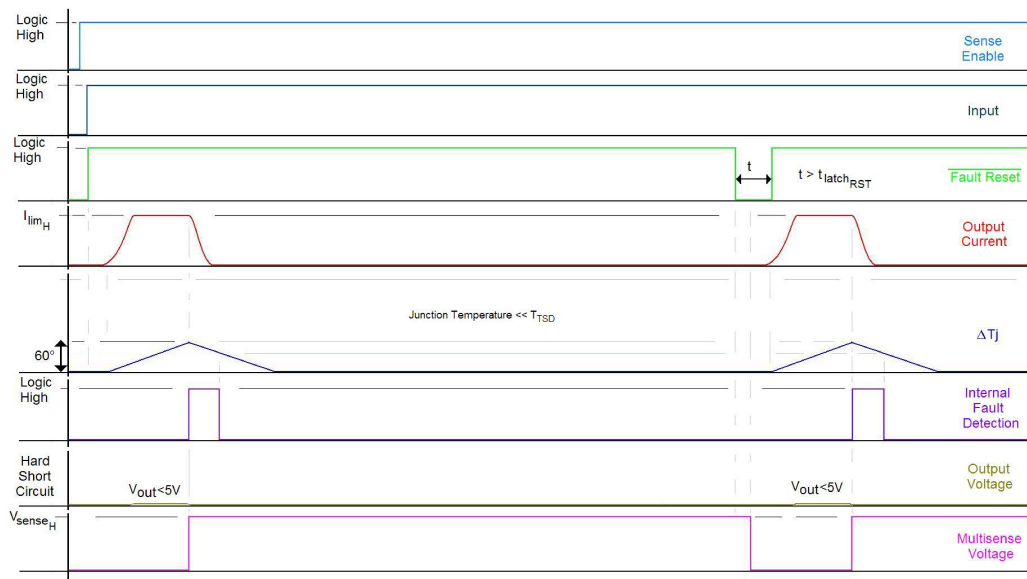


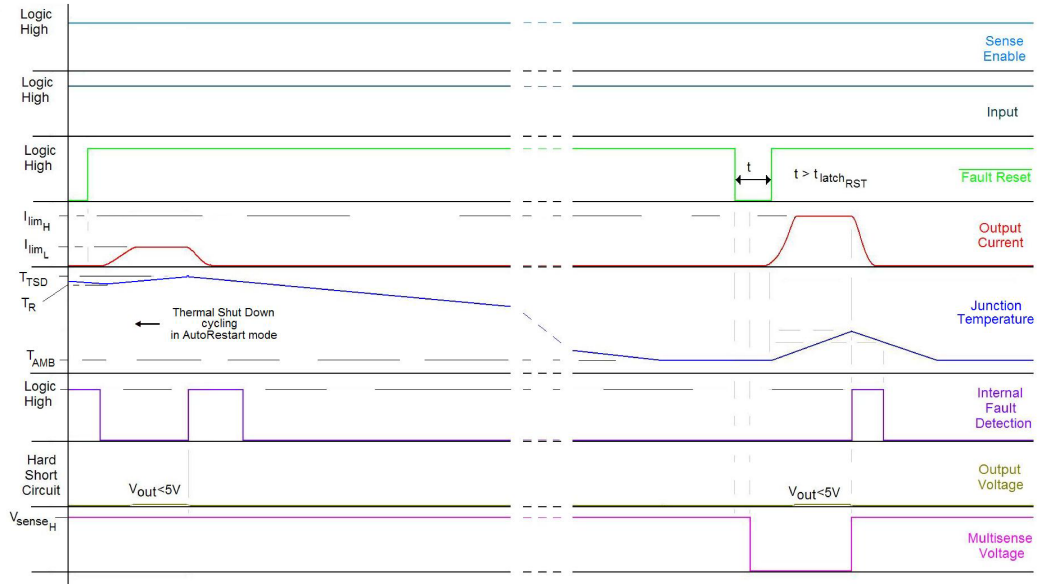
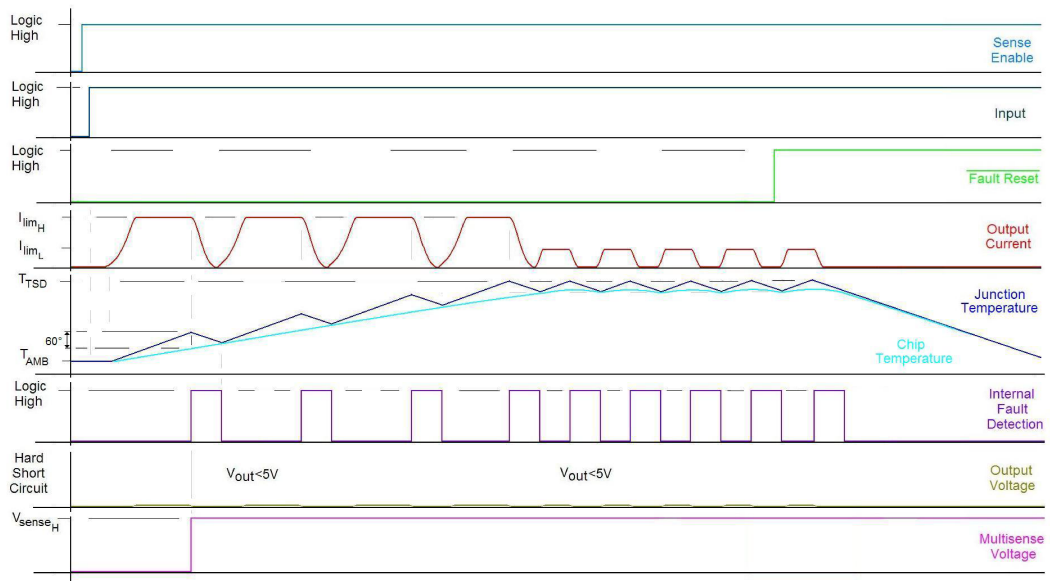
Figure 10. Latch functionality: behavior in hard short-circuit condition

Figure 11. Latch functionality: behavior in hard short-circuit condition (autorestart mode + latch off)


Figure 12. Standby mode activation

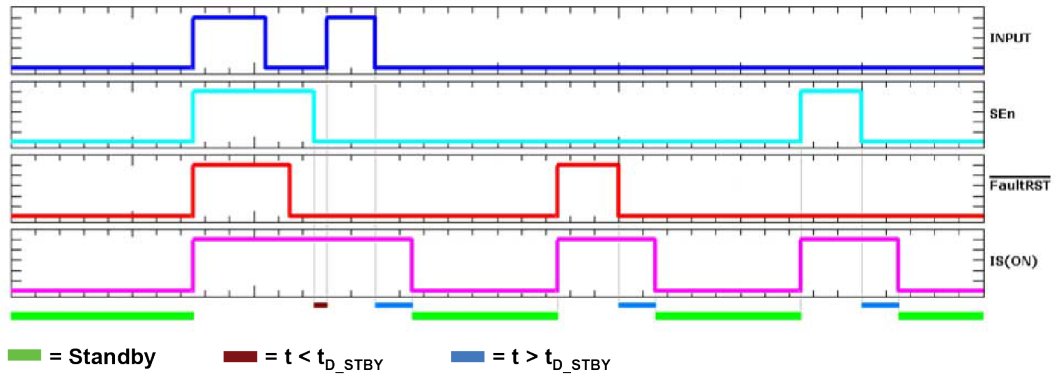
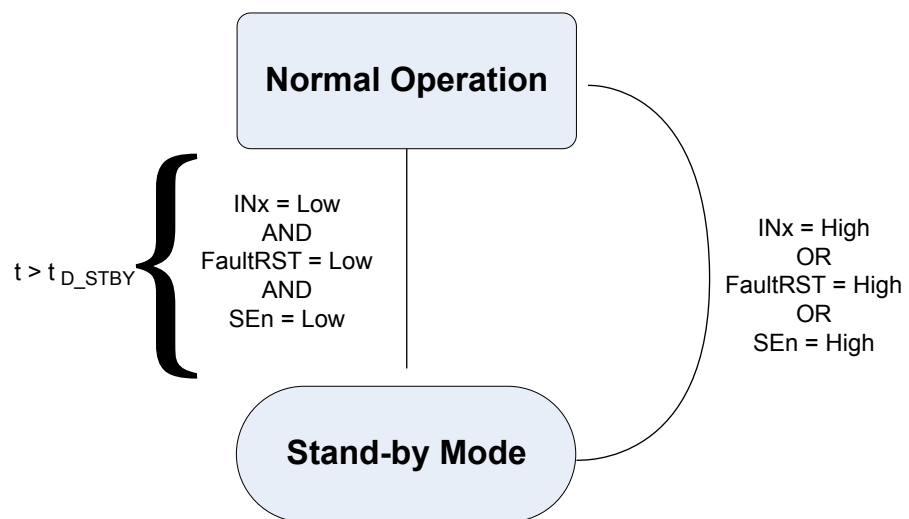


Figure 13. Standby state diagram



2.5 Electrical characteristics curves

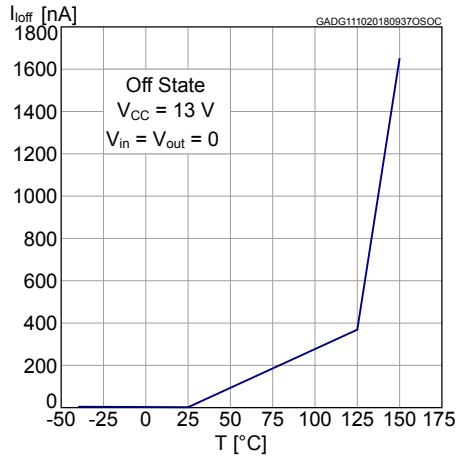
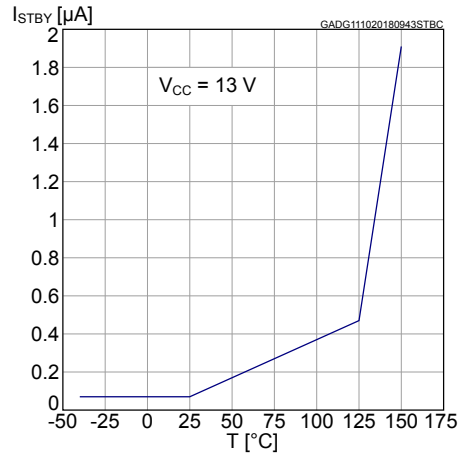
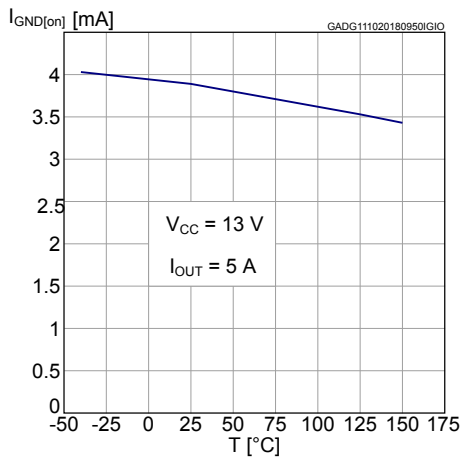
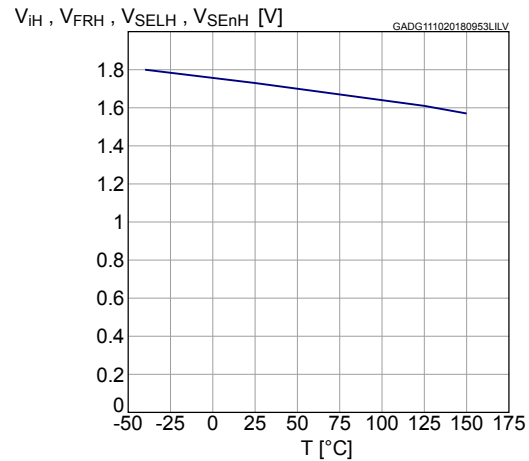
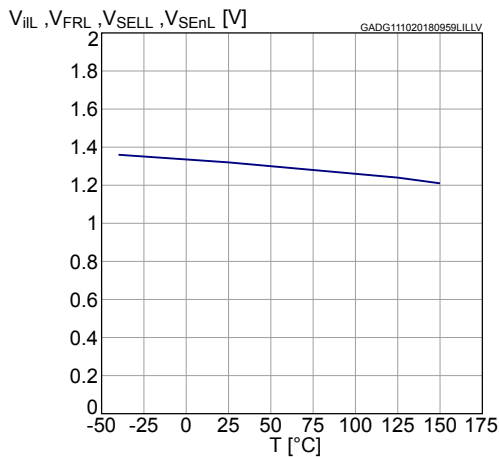
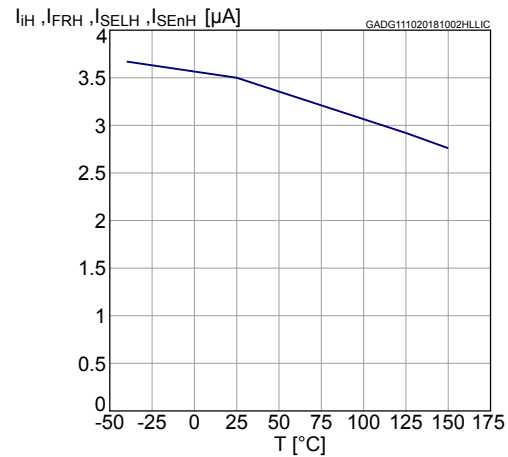
Figure 14. OFF-state output current

Figure 15. Standby current

Figure 16. $I_{GND(ON)}$ vs. I_{out}

Figure 17. Logic input high level voltage

Figure 18. Logic input low level voltage

Figure 19. High level logic input current


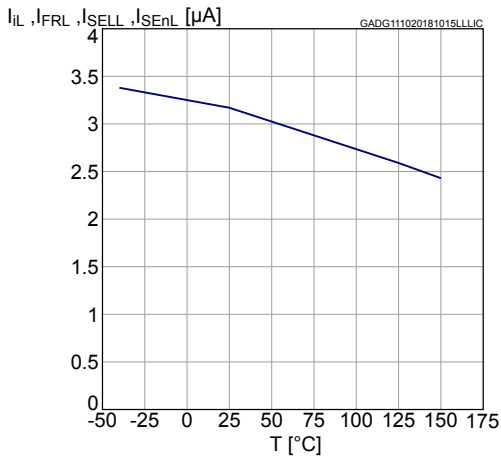
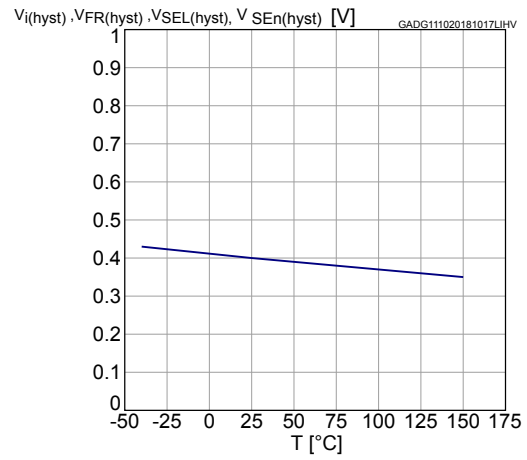
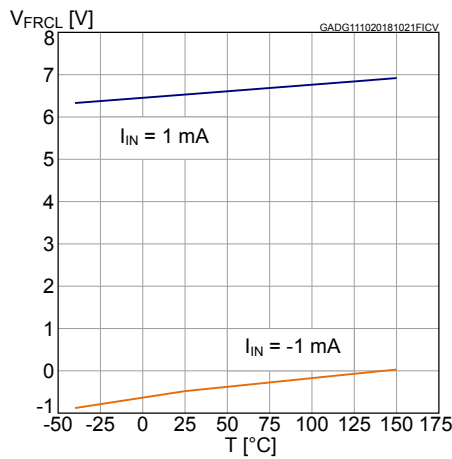
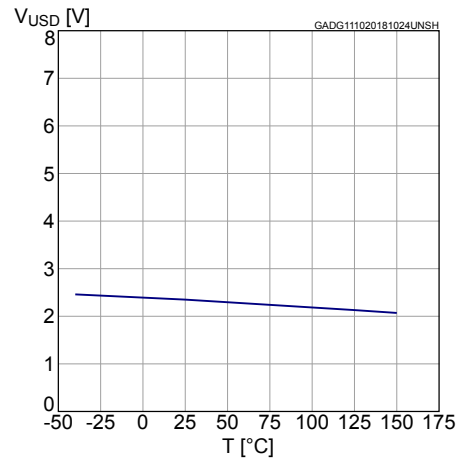
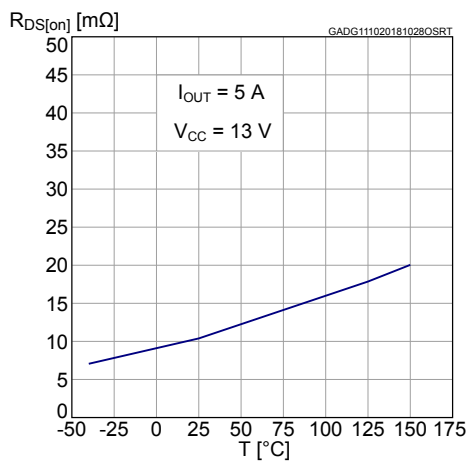
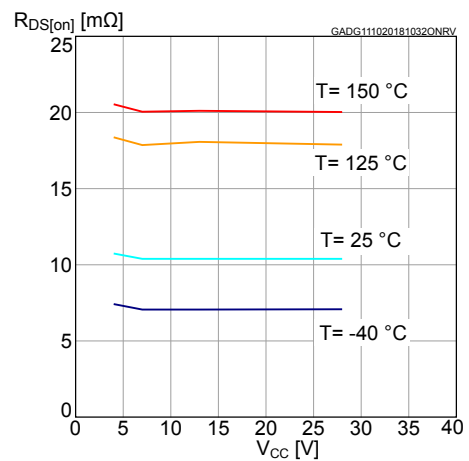
Figure 20. Low level logic input current

Figure 21. Logic input hysteresis voltage

Figure 22. FaultRST Input clamp voltage

Figure 23. Undervoltage shutdown

Figure 24. On-state resistance vs. T_{case}

Figure 25. On-state resistance vs. V_{CC}


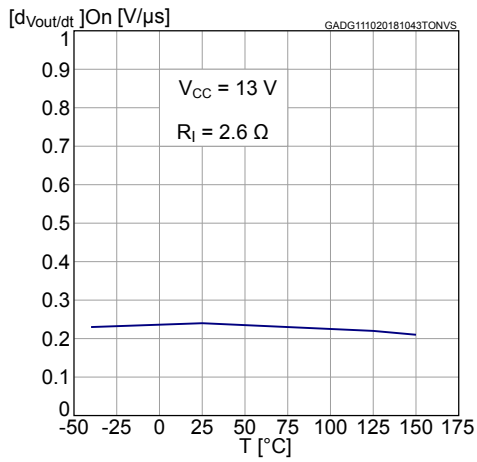
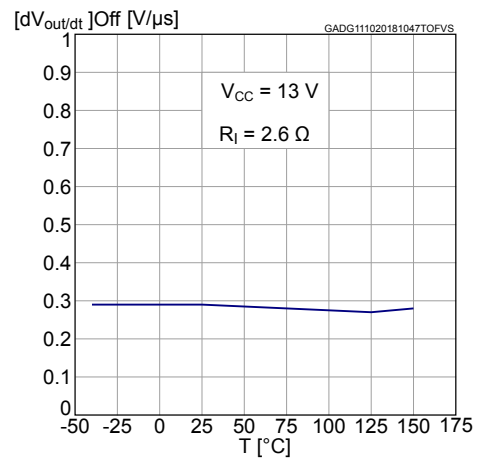
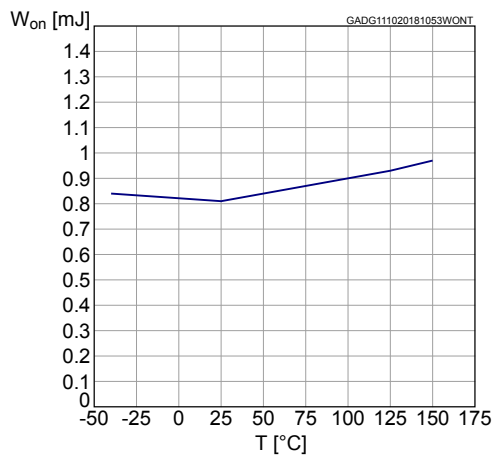
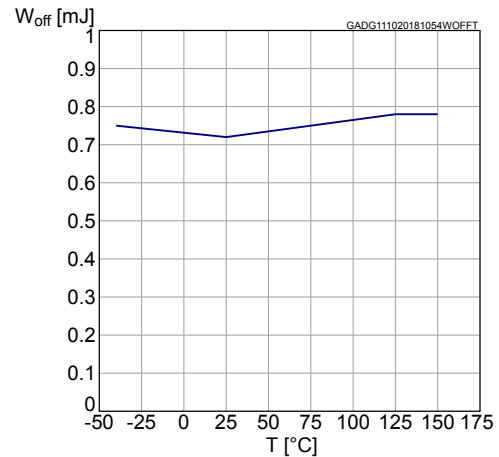
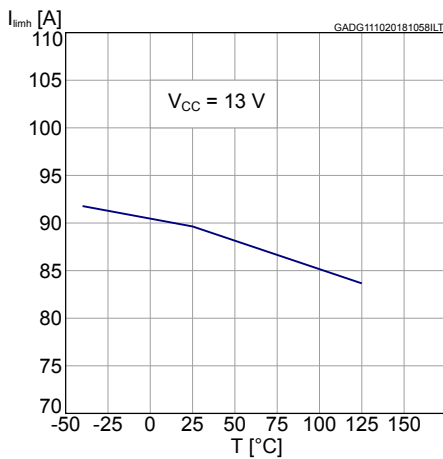
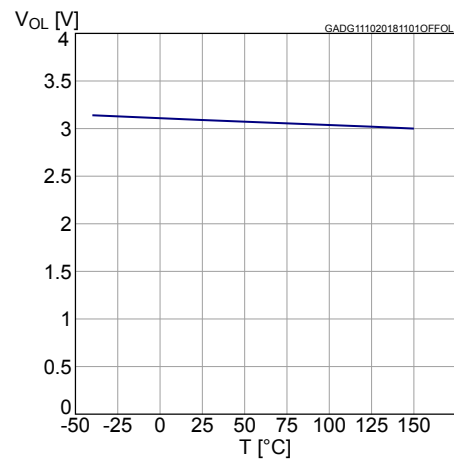
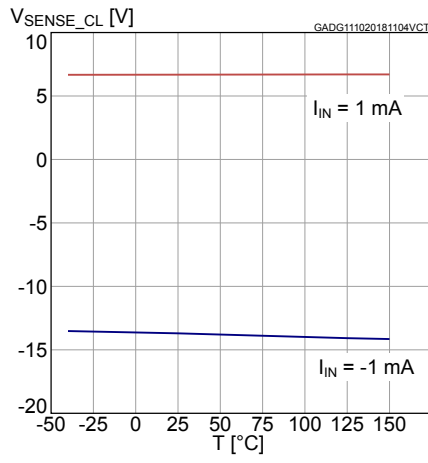
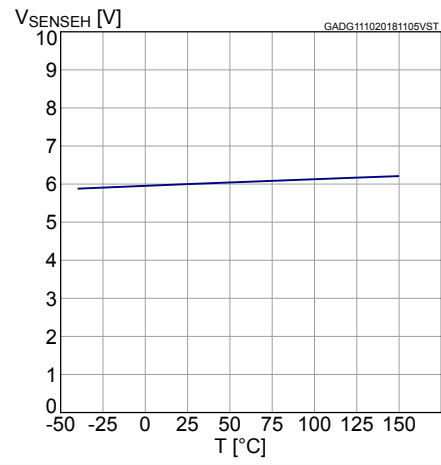
Figure 26. Turn-on voltage slope

Figure 27. Turn-off voltage slope

Figure 28. W_{on} vs. T_{case}

Figure 29. W_{off} vs. T_{case}

Figure 30. I_{LIMH} vs. T_{case}

Figure 31. OFF-state open-load voltage detection threshold


Figure 32. $V_{\text{sense clamp}}$ vs. T_{case}

Figure 33. V_{senseh} vs. T_{case}


3 Protections

3.1 Power limitation

The basic working principle of this protection consists of an indirect measurement of the junction temperature swing ΔT_j through the direct measurement of the spatial temperature gradient on the device surface in order to automatically shut off the output MOSFET as soon as ΔT_j exceeds the safety level of ΔT_{j_SD} . According to the voltage level on the $\overline{\text{FaultRST}}$ pin, the output MOSFET switches on and cycles with a thermal hysteresis according to the maximum instantaneous power which can be handled ($\overline{\text{FaultRST}} = \text{Low}$) or remains off ($\overline{\text{FaultRST}} = \text{High}$). The protection prevents fast thermal transient effects and, consequently, reduces thermo-mechanical fatigue.

3.2 Thermal shutdown

In case the junction temperature of the device exceeds the maximum allowed threshold (typically 175°C), it automatically switches off and the diagnostic indication is triggered. According to the voltage level on the $\overline{\text{FaultRST}}$ pin, the device switches on again as soon as its junction temperature drops to T_R ($\overline{\text{FaultRST}} = \text{Low}$) or remains off ($\overline{\text{FaultRST}} = \text{High}$).

3.3 Current limitation

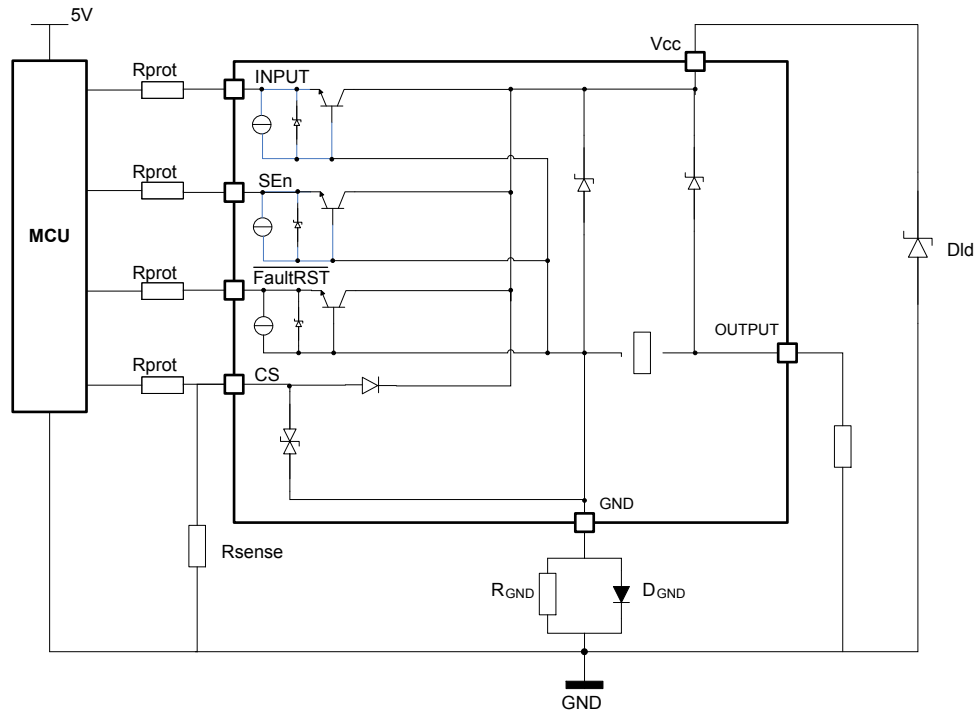
The device is equipped with an output current limiter in order to protect the silicon as well as the other components of the system (e.g. bonding wires, wiring harness, connectors, loads, etc.) from excessive current flow. Consequently, in case of short circuit, overload or during load power-up, the output current is clamped to a safety level, I_{LIMH} , by operating the output power MOSFET in the active region.

3.4 Negative voltage clamp

In case the device drives inductive load, the output voltage reaches a negative value during turn off. A negative voltage clamp structure limits the maximum negative voltage to a certain value, V_{DEMAG} , allowing the inductor energy to be dissipated without damaging the device.

4.1 GND protection network against reverse battery

Figure 35. Simplified internal structure



GAPGCF00830

4.1.1 Diode (D_{GND}) in the ground line

A resistor (typ. $R_{GND} = 4.7 \text{ k}\Omega$) should be inserted in parallel to D_{GND} if the device drives an inductive load.

This small signal diode can be safely shared amongst several different HSDs. Also in this case, the presence of the ground network produces a shift ($\approx 600 \text{ mV}$) in the input threshold and in the status output values if the microprocessor ground is not common to the device ground. This shift does not vary if more than one HSD shares the same diode/resistor network.

4.2 Immunity against transient electrical disturbances

The immunity of the device against transient electrical emissions, conducted along the supply lines and injected into the V_{CC} pin, is tested in accordance with ISO7637-2:2011 (E) and ISO 16750-2:2010.

The related function performance status classification is shown in [Table 13. ISO 7637-2 - electrical transient conduction along supply line](#).

Test pulses are applied directly to DUT (Device Under Test) both in ON and OFF-state and in accordance to ISO 7637-2:2011(E), chapter 4. The DUT is intended as the present device only, without components and accessed through V_{CC} and GND terminals.

Status II is defined in ISO 7637-1 Function Performance Status Classification (FPSC) as follows: "The function does not perform as designed during the test but returns automatically to normal operation after the test".

Table 13. ISO 7637-2 - electrical transient conduction along supply line

Test Pulse 2011(E)	Test pulse severity level with Status II functional performance status		Minimum number of pulses or test time	Burst cycle / pulse repetition time		Pulse duration and pulse generator internal impedance
	Level	U_S ⁽¹⁾		min	max	
1	III	-112 V	500 pulses	0.5 s		2 ms, 10 Ω
2a ⁽³⁾	III	+55 V	500 pulses	0.2 s	5 s	50 μ s, 2 Ω
3a	IV	-220 V	1h	90 ms	100 ms	0.1 μ s, 50 Ω
3b	IV	+150 V	1h	90 ms	100 ms	0.1 μ s, 50 Ω
4 ⁽²⁾	IV	-7 V	1 pulse			100 ms, 0.01 Ω
Load dump according to ISO 16750-2:2010						
Test B ⁽³⁾		40 V	5 pulse	1 min		400 ms, 2 Ω

- U_S is the peak amplitude as defined for each test pulse in ISO 7637-2:2011(E), chapter 5.6.
- Test pulse from ISO 7637-2:2004(E).
- With 40 V external suppressor referred to ground ($-40^\circ\text{C} < T_j < 150^\circ\text{C}$).

4.3 MCU I/Os protection

If a ground protection network is used and negative transients are present on the V_{CC} line, the control pins will be pulled negative. ST suggests to insert a resistor (R_{prot}) in line both to prevent the microcontroller I/O pins from latching-up and to protect the HSD inputs.

The value of these resistors is a compromise between the leakage current of microcontroller and the current required by the HSD I/Os (Input levels compatibility) with the latch-up limit of microcontroller I/Os.

Equation

$$V_{CCpeak}/I_{latchup} \leq R_{prot} \leq (V_{OH\mu C} - V_{IH} - V_{GND}) / I_{IHmax}$$

Calculation example:

For $V_{CCpeak} = -150$ V; $I_{latchup} \geq 20$ mA; $V_{OH\mu C} \geq 4.5$ V

7.5 k $\Omega \leq R_{prot} \leq 140$ k Ω .

Recommended values: $R_{prot} = 15$ k Ω

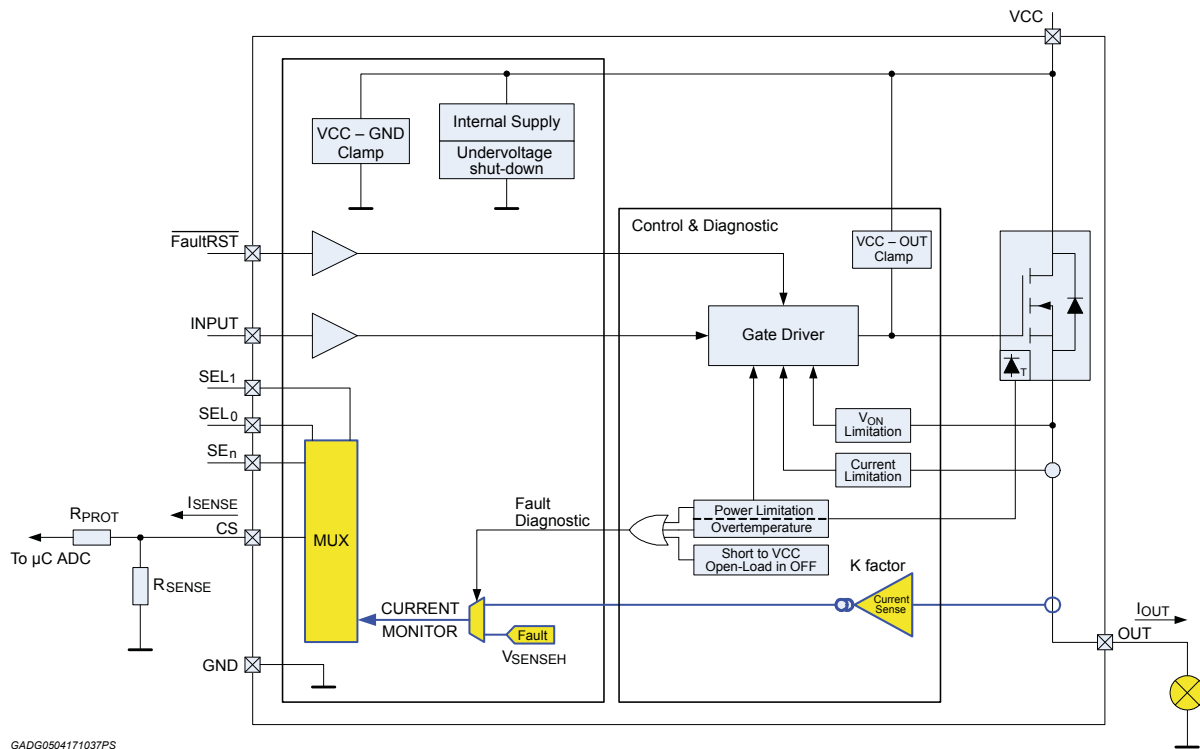
4.4 CS - analog current sense

Diagnostic information on device and load status are provided by an analog output pin (CS) delivering the following signals:

- Current monitor: current mirror of channel output current

Those signals are routed through an analog multiplexer which is configured and controlled by means of SELx and SEN pins, according to the address map in *MultiSense multiplexer addressing Table*.

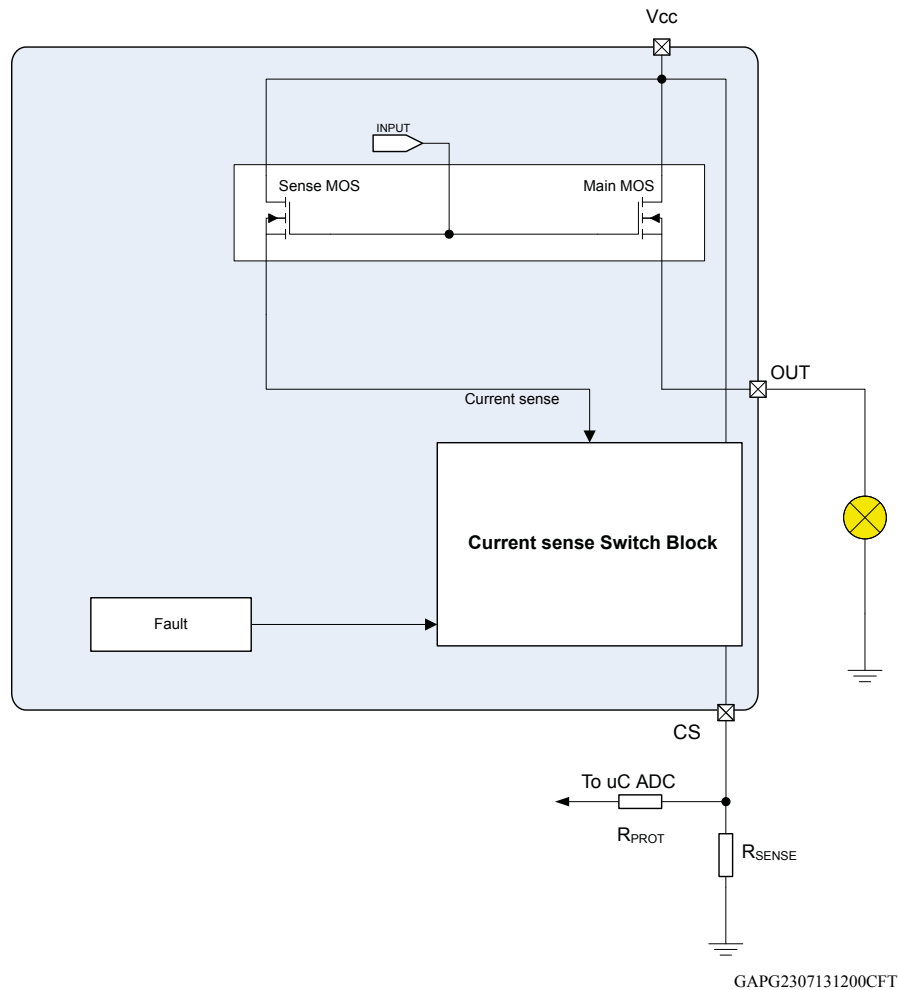
Figure 36. CurrentSense and diagnostic – block diagram



GADG0504171037PS

4.4.1 Principle of CurrentSense signal generation

Figure 37. CurrentSense block diagram



Current sense

The output is able to provide:

- Current mirror proportional to the load current in normal operation, delivering current proportional to the load according to a known ratio named **K**
- Diagnostics flag in fault conditions delivering fixed voltage V_{SENSEH}

The current delivered by the current sense circuit, I_{SENSE} , can be easily converted into a voltage V_{SENSE} by using an external sense resistor, R_{SENSE} , allowing continuous load monitoring and abnormal condition detection.

Normal operation (channel ON, no fault, SEn active)

While device is operating in normal conditions (no fault intervention), V_{SENSE} calculation can be done using simple equations

Current provided by CS output: $I_{SENSE} = I_{OUT}/K$

Voltage on R_{SENSE} : $V_{SENSE} = R_{SENSE} \cdot I_{SENSE} = R_{SENSE} \cdot I_{OUT}/K$

Where:

- V_{SENSE} is the voltage measurable on R_{SENSE} resistor

Figure 39. Open-load / short to V_{CC} condition

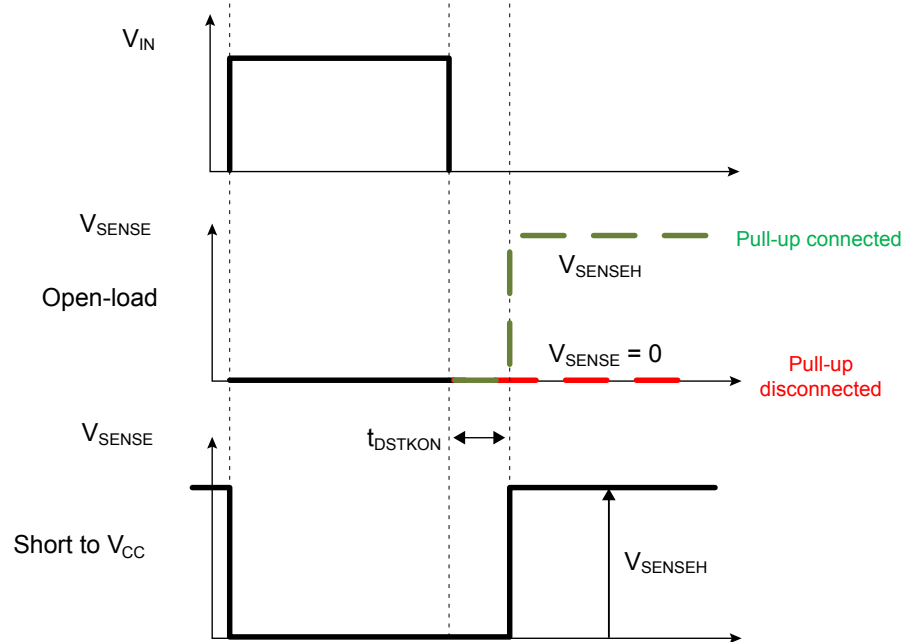


Table 14. CurrentSense pin levels in off-state

Condition	Output	CS	SEn
Open-load	$V_{OUT} > V_{OL}$	Hi-Z	L
		V_{SENSEH}	H
	$V_{OUT} < V_{OL}$	Hi-Z	L
		0	H
Short to V_{CC}	$V_{OUT} > V_{OL}$	Hi-Z	L
		V_{SENSEH}	H
Nominal	$V_{OUT} < V_{OL}$	Hi-Z	L
		0	H

4.4.2 Short to V_{CC} and OFF-state open-load detection

Short to V_{CC}

A short circuit between V_{CC} and output is indicated by the relevant current sense pin set to V_{SENSEH} during the device off-state. Small or no current is delivered by the current sense during the on-state depending on the nature of the short circuit.

OFF-state open-load with external circuitry

Detection of an open-load in off mode requires an external pull-up resistor R_{PU} connecting the output to a positive supply voltage V_{PU} .

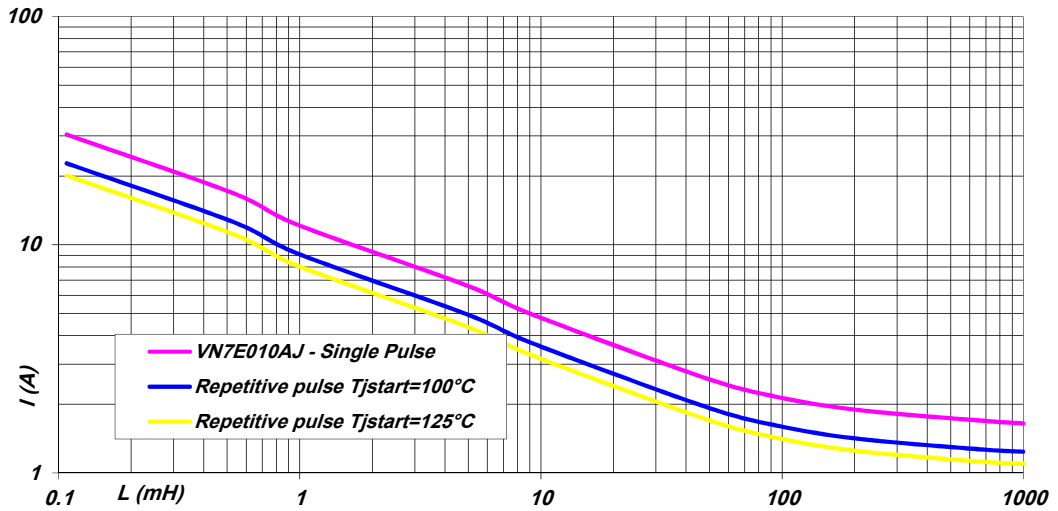
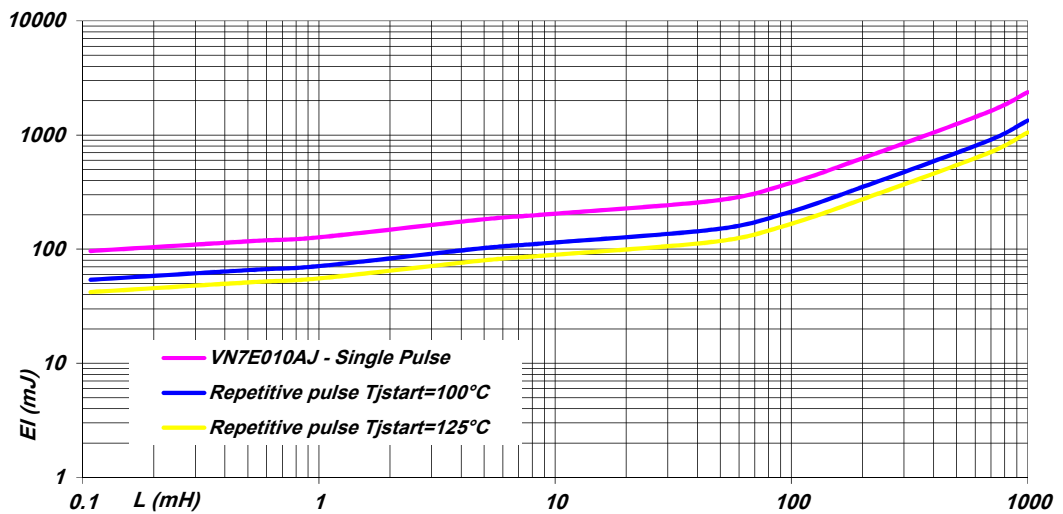
It is preferable that V_{PU} is switched off during the module standby mode in order to avoid the overall standby current consumption to increase in normal conditions, i.e. when load is connected.

R_{PU} must be selected in order to ensure $V_{OUT} > V_{OLmax}$ in accordance with the following equation:

Equation

$$R_{PU} < \frac{V_{PU} - 4}{I_{L(off2)min @ 4V}}$$

5 Maximum demagnetization energy ($V_{CC} = 16\text{ V}$)

Figure 41. Maximum turn off current versus inductance

Figure 42. Maximum turn off energy versus inductance


Note: Values are generated with $R_L = 0\ \Omega$.

In case of repetitive pulses, T_{jstart} (at beginning of each demagnetization) of every pulse must not exceed the temperature specified above for curves A and B.

6 Package and PCB thermal data

6.1 PowerSSO-16 thermal data

Figure 43. PowerSSO-16 on two-layers PCB (2s0p to JEDEC JESD 51-5)

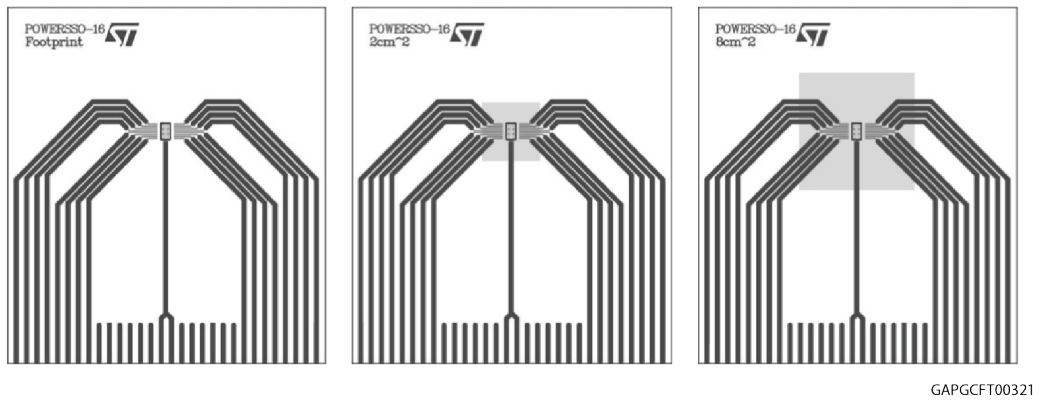


Figure 44. PowerSSO-16 on four-layers PCB (2s2p to JEDEC JESD 51-7)

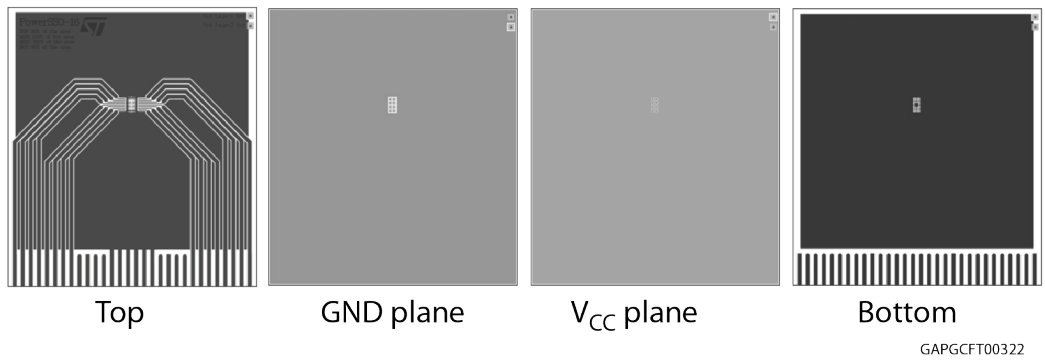


Table 15. PCB properties

Dimension	Value
Board finish thickness	1.6 mm +/- 10%
Board dimension	77 mm x 86 mm
Board material	FR4
Copper thickness (top and bottom layers)	0.070 mm
Copper thickness (inner layers)	0.035 mm
Thermal vias separation	1.2 mm
Thermal via diameter	0.3 mm +/- 0.08 mm
Copper thickness on vias	0.025 mm
Footprint dimension (top layer)	2.2 mm x 3.9 mm
Heatsink copper area dimension (bottom layer)	Footprint, 2 cm ² or 8 cm ²

Figure 45. $R_{thj-amb}$ vs PCB copper area in open box free air condition (one channel on)

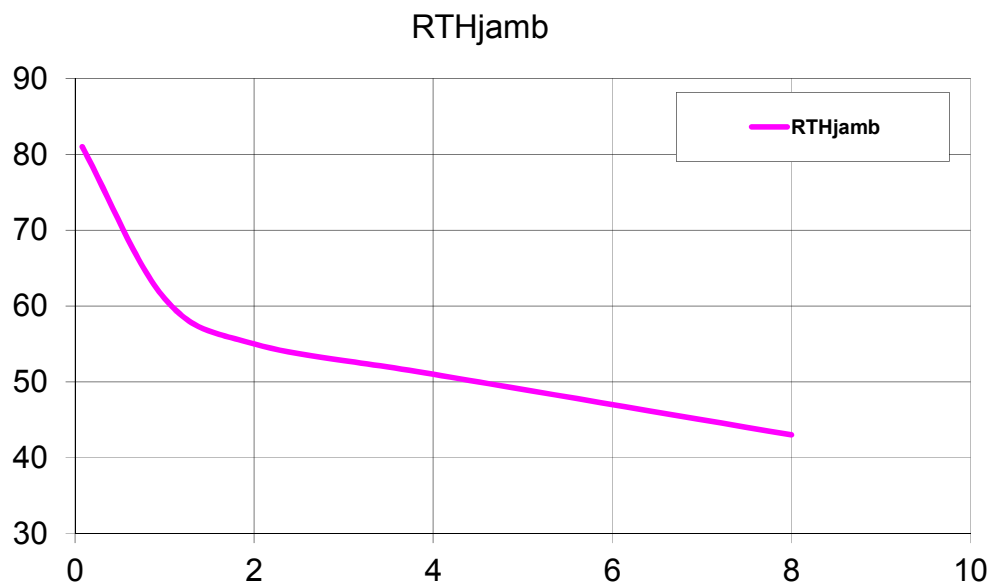
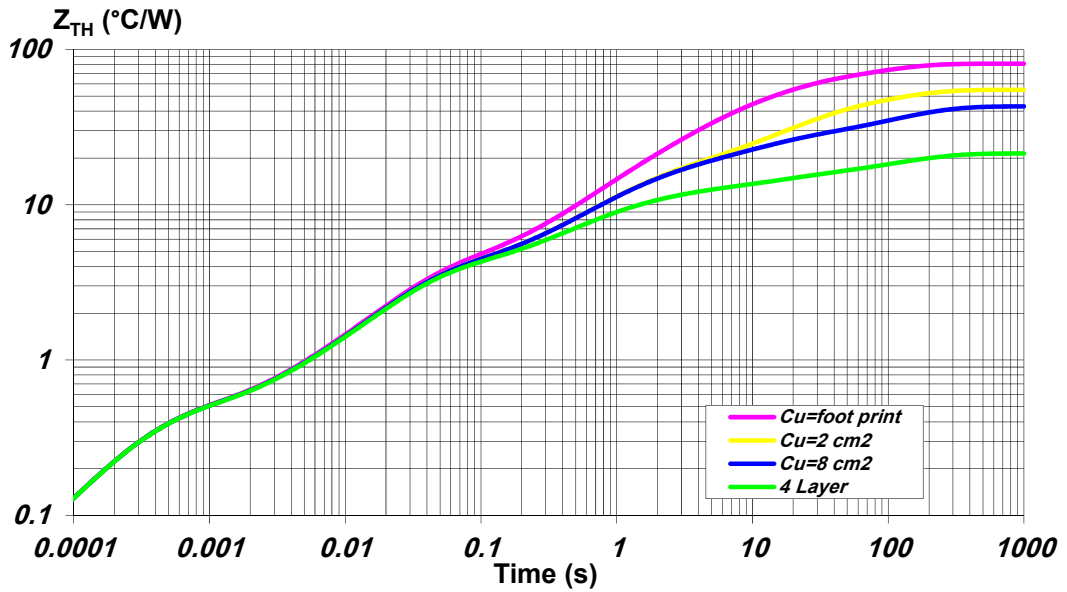


Figure 46. PowerSSO-16 thermal impedance junction ambient single pulse (one channel on)

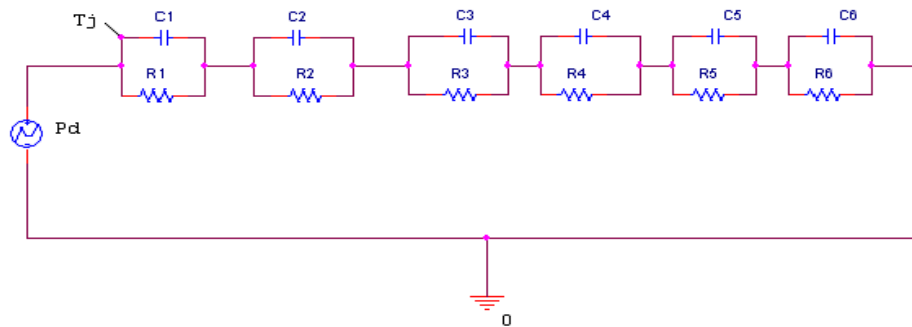


Equation: pulse calculation formula

$$Z_{TH\delta} = R_{TH} \cdot \delta + Z_{THtp} (1 - \delta)$$

where $\delta = t_p/T$

Figure 47. Thermal fitting model of a double-channel HSD in PowerSSO-16



Note: The fitting model is a simplified thermal tool and is valid for transient evolutions where the embedded protections (power limitation or thermal cycling during thermal shutdown) are not triggered.

Table 16. Thermal parameters

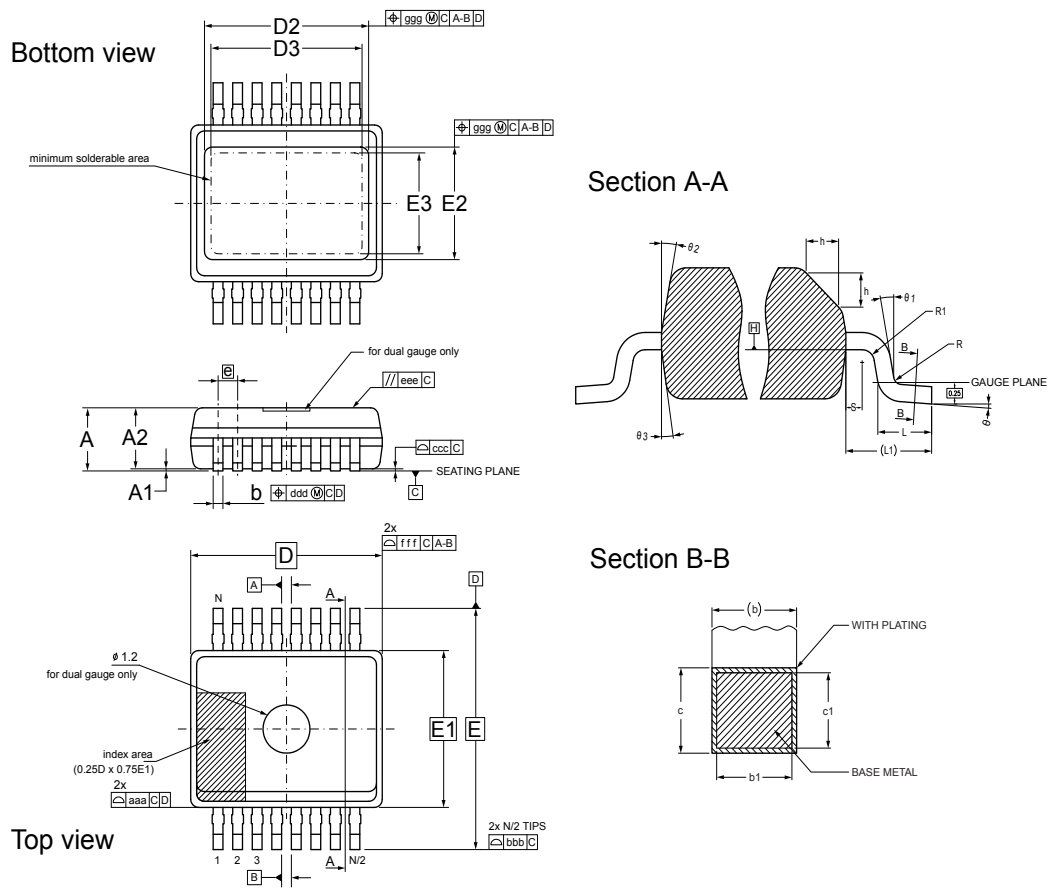
Area/island (cm ²)	FP	2	8	4L
R1 (°C/W)	0.4			
R2 (°C/W)	3			
R3 (°C/W)	5.6	5.6	5.6	4
R4 (°C/W)	16	6	6	4
R5 (°C/W)	30	20	10	3
R6 (°C/W)	26	20	18	7
C1 (W·s/°C)	0.0007			
C2 (W·s/°C)	0.009			
C3 (W·s/°C)	0.13			
C4 (W·s/°C)	0.2	0.3	0.3	0.4
C5 (W·s/°C)	0.4	1	1	4
C6 (W·s/°C)	3	5	7	18

7 Package information

In order to meet environmental requirements, ST offers these devices in different grades of **ECOPACK®** packages, depending on their level of environmental compliance. ECOPACK® specifications, grade definitions and product status are available at: www.st.com. ECOPACK® is an ST trademark.

7.1 PowerSSO-16 package information

Figure 48. PowerSSO-16 package dimensions



8017965_Rev_9



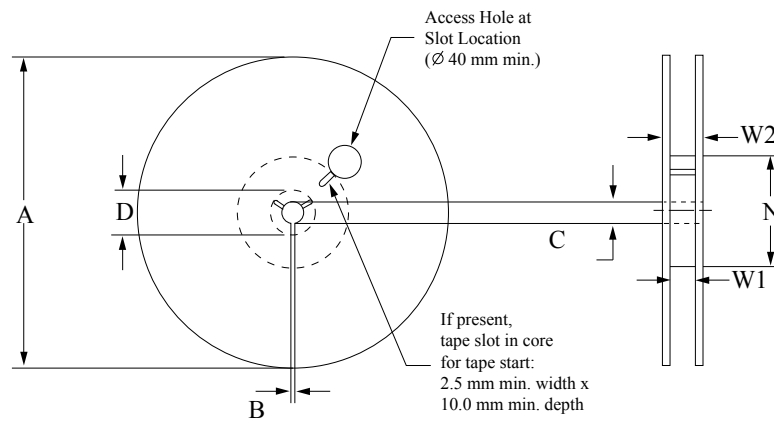
GAPG1605141159CFT

Table 17. PowerSSO-16 mechanical data

Symbol	Millimeters		
	Min.	Typ.	Max.
Θ	0°		8°
Θ1	0°		
Θ2	5°		15°
Θ3	5°		15°
A			1.70
A1	0.00		0.10
A2	1.10		1.60
b	0.20		0.30
b1	0.20	0.25	0.28
c	0.19		0.25
c1	0.19	0.20	0.23
D	4.90 BSC		
D2	3.31		3.91
D3	2.61		
e	0.50 BSC		
E	6.00 BSC		
E1	3.90 BSC		
E2	2.20		2.80
E3	1.49		
h	0.25		0.50
L	0.40	0.60	0.85
L1	1.00 REF		
N	16		
R	0.07		
R1	0.07		
S	0.20		
Tolerance of form and position			
aaa	0.10		
bbb	0.10		
ccc	0.08		
ddd	0.08		
eee	0.10		
fff	0.10		
ggg	0.15		

7.2 PowerSSO-16 packing information

Figure 49. PowerSSO-16 reel 13"



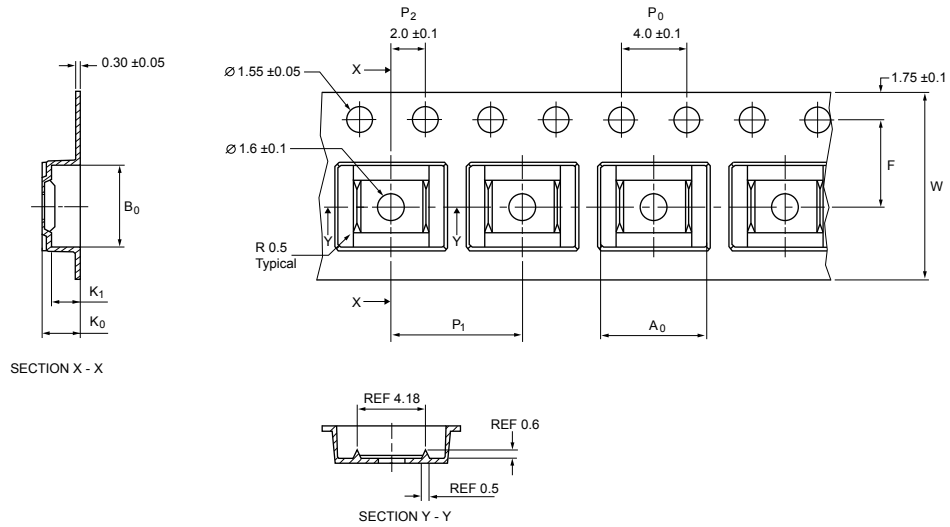
TAPG2004151655CFT

Table 18. Reel dimensions

Description	Value ⁽¹⁾
Base quantity	2500
Bulk quantity	2500
A (max)	330
B (min)	1.5
C (+0.5, -0.2)	13
D (min)	20.2
N	100
W1 (+2 /-0)	12.4
W2 (max)	18.4

1. All dimensions are in mm.

Figure 50. PowerSSO-16 carrier tape



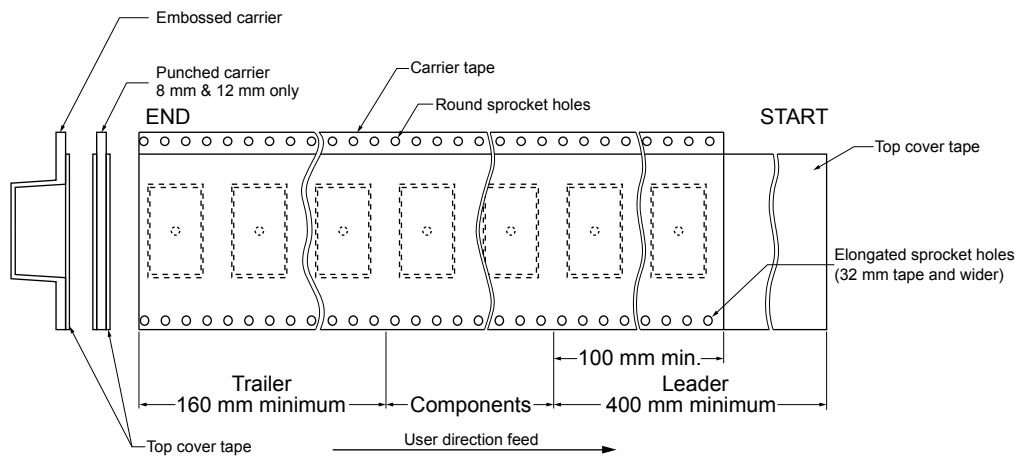
GAPG2204151242CFT

Table 19. PowerSSO-16 carrier tape dimensions

Description	Value ⁽¹⁾
A_0	6.50 ± 0.1
B_0	5.25 ± 0.1
K_0	2.10 ± 0.1
K_1	1.80 ± 0.1
F	5.50 ± 0.1
P_1	8.00 ± 0.1
W	12.00 ± 0.3

1. All dimensions are in mm.

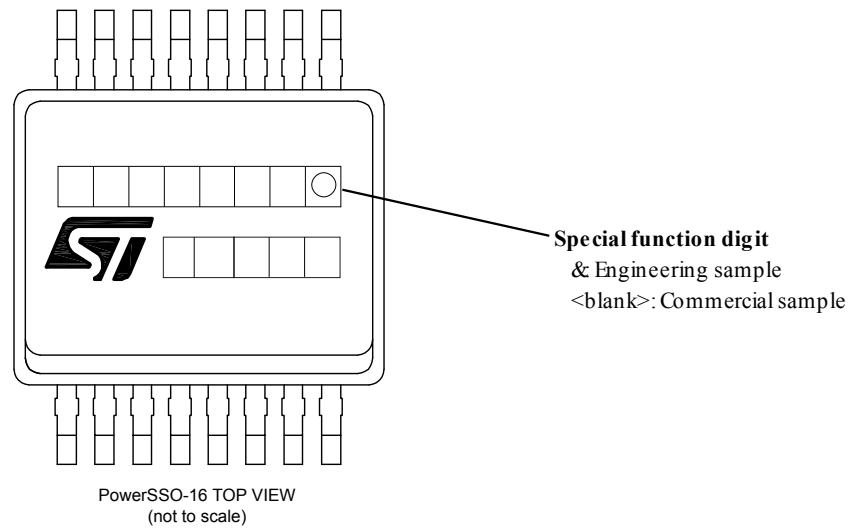
Figure 51. PowerSSO-16 schematic drawing of leader and trailer tape



GAPG2004151511CFT

7.3 PowerSSO-16 marking information

Figure 52. PowerSSO-16 marking information



GADG0310161234SMD

Parts marked as '&' are not yet qualified and therefore not approved for use in production. ST is not responsible for any consequences resulting from such use. In no event will ST be liable for the customer using any of these engineering samples in production. ST's Quality department must be contacted prior to any decision to use these engineering samples to run a qualification activity.

8 Ordering information

Table 20. Ordering information

Package	Order codes
	Tape and reel
VN7E010AJTR	PowerSSO-16

Revision history

Table 21. Document revision history

Date	Revision	Changes
18-Jan-2017	1	Initial release.
09-Oct-2017	2	Updated <i>Figure 3: "Current and voltage conventions"</i> Updated value for E_{MAX} <i>Table 3: "Absolute maximum ratings"</i> Updated <i>Table 6: "Power section"</i> Updated <i>Table 7: "Switching"</i> . Updated <i>Table 10: "CurrentSense"</i> Updated <i>Table 13: "ISO 7637-2 - electrical transient conduction along supply line"</i>
19-Jun-2018	3	Updated applications in cover page. Updated <i>Table 3. Absolute maximum ratings, Section 2.2 Thermal data and Section 8 Ordering information.</i> Inserted <i>Section 5 Maximum demagnetization energy (VCC = 16 V) and Section 6 Package and PCB thermal data.</i>
11-Oct-2018	4	Updated <i>Table 5. Electrical characteristics during cranking and Table 7. Switching.</i> Added <i>Section 2.5 Electrical characteristics curves .</i>
08-Nov-2018	5	Updated features in cover page, <i>Table 4. Thermal data and Section 7.1 PowerSSO-16 package information.</i>

Contents

1	Block diagram and pin description	3
2	Electrical specification	5
2.1	Absolute maximum ratings	5
2.2	Thermal data	6
2.3	Main electrical characteristics	6
2.4	Waveforms	14
2.5	Electrical characteristics curves	17
3	Protections	21
3.1	Power limitation	21
3.2	Thermal shutdown	21
3.3	Current limitation	21
3.4	Negative voltage clamp	21
4	Application information	22
4.1	GND protection network against reverse battery	22
4.1.1	Diode (DGND) in the ground line	23
4.2	Immunity against transient electrical disturbances	23
4.3	MCU I/Os protection	24
4.4	CS - analog current sense	24
4.4.1	Principle of CurrentSense signal generation	25
4.4.2	Short to VCC and OFF-state open-load detection	28
5	Maximum demagnetization energy (VCC = 16 V)	30
6	Package and PCB thermal data	31
6.1	PowerSSO-16 thermal data	31
7	Package information	35
7.1	PowerSSO-16 package information	35
7.2	PowerSSO-16 packing information	36
7.3	PowerSSO-16 marking information	38
8	Ordering information	40
	Revision history	41

List of tables

Table 1.	Pin functions	3
Table 2.	Suggested connections for unused and not connected pins	4
Table 3.	Absolute maximum ratings	5
Table 4.	Thermal data	6
Table 5.	Electrical characteristics during cranking	6
Table 6.	Power section	6
Table 7.	Switching	7
Table 8.	Logic inputs	8
Table 9.	Protections	9
Table 10.	CurrentSense	9
Table 11.	Truth table	13
Table 12.	CurrentSense multiplexer addressing	14
Table 13.	ISO 7637-2 - electrical transient conduction along supply line	24
Table 14.	CurrentSense pin levels in off-state	28
Table 15.	PCB properties	32
Table 16.	Thermal parameters	34
Table 17.	PowerSSO-16 mechanical data	36
Table 18.	Reel dimensions	37
Table 19.	PowerSSO-16 carrier tape dimensions	38
Table 20.	Ordering information	40
Table 21.	Document revision history	41

List of figures

Figure 1.	Block diagram	3
Figure 2.	Configuration diagram (top view).	4
Figure 3.	Current and voltage conventions.	5
Figure 4.	I_{OUT}/I_{SENSE} versus I_{OUT}	11
Figure 5.	Current sense accuracy versus I_{OUT}	12
Figure 6.	Switching time and pulse skew	12
Figure 7.	CurrentSense timings (current sense mode).	13
Figure 8.	T_{DSTKON}	13
Figure 9.	Latch functionality: behavior in hard short-circuit condition ($T_{AMB} \ll T_{TSD}$).	14
Figure 10.	Latch functionality: behavior in hard short-circuit condition	15
Figure 11.	Latch functionality: behavior in hard short-circuit condition (autorestart mode + latch off)	15
Figure 12.	Standby mode activation	16
Figure 13.	Standby state diagram.	16
Figure 14.	OFF-state output current	17
Figure 15.	Standby current	17
Figure 16.	$I_{GND(ON)}$ vs. I_{out}	17
Figure 17.	Logic input high level voltage	17
Figure 18.	Logic input low level voltage.	17
Figure 19.	High level logic input current.	17
Figure 20.	Low level logic input current	18
Figure 21.	Logic input hysteresis voltage.	18
Figure 22.	FaultRST Input clamp voltage.	18
Figure 23.	Undervoltage shutdown	18
Figure 24.	On-state resistance vs. T_{case}	18
Figure 25.	On-state resistance vs. V_{CC}	18
Figure 26.	Turn-on voltage slope	19
Figure 27.	Turn-off voltage slope	19
Figure 28.	W_{on} vs. T_{case}	19
Figure 29.	W_{off} vs. T_{case}	19
Figure 30.	I_{LIMH} vs. T_{case}	19
Figure 31.	OFF-state open-load voltage detection threshold	19
Figure 32.	V_{sense} clamp vs. T_{case}	20
Figure 33.	V_{senseh} vs. T_{case}	20
Figure 34.	Application diagram.	22
Figure 35.	Simplified internal structure	23
Figure 36.	CurrentSense and diagnostic – block diagram	25
Figure 37.	CurrentSense block diagram	26
Figure 38.	Analog HSD – open-load detection in off-state	27
Figure 39.	Open-load / short to V_{CC} condition	28
Figure 41.	Maximum turn off current versus inductance.	30
Figure 42.	Maximum turn off energy versus inductance.	30
Figure 43.	PowerSSO-16 on two-layers PCB (2s0p to JEDEC JESD 51-5)	31
Figure 44.	PowerSSO-16 on four-layers PCB (2s2p to JEDEC JESD 51-7)	31
Figure 45.	$R_{thj-amb}$ vs PCB copper area in open box free air condition (one channel on)	32
Figure 46.	PowerSSO-16 thermal impedance junction ambient single pulse (one channel on)	33
Figure 47.	Thermal fitting model of a double-channel HSD in PowerSSO-16	33
Figure 48.	PowerSSO-16 package dimensions	35
Figure 49.	PowerSSO-16 reel 13"	37
Figure 50.	PowerSSO-16 carrier tape	38
Figure 51.	PowerSSO-16 schematic drawing of leader and trailer tape	38

Figure 52. PowerSSO-16 marking information 39

IMPORTANT NOTICE – PLEASE READ CAREFULLY

STMicroelectronics NV and its subsidiaries (“ST”) reserve the right to make changes, corrections, enhancements, modifications, and improvements to ST products and/or to this document at any time without notice. Purchasers should obtain the latest relevant information on ST products before placing orders. ST products are sold pursuant to ST’s terms and conditions of sale in place at the time of order acknowledgement.

Purchasers are solely responsible for the choice, selection, and use of ST products and ST assumes no liability for application assistance or the design of Purchasers’ products.

No license, express or implied, to any intellectual property right is granted by ST herein.

Resale of ST products with provisions different from the information set forth herein shall void any warranty granted by ST for such product.

ST and the ST logo are trademarks of ST. All other product or service names are the property of their respective owners.

Information in this document supersedes and replaces information previously supplied in any prior versions of this document.

© 2018 STMicroelectronics – All rights reserved

X-ON Electronics

Largest Supplier of Electrical and Electronic Components

Click to view similar products for [Power Switch ICs - Power Distribution](#) *category:*

Click to view products by [STMicroelectronics](#) *manufacturer:*

Other Similar products are found below :

[TCK111G,LF\(S](#) [FPF1018](#) [DS1222](#) [TCK2065G,LF](#) [SZNCP3712ASNT3G](#) [MIC2033-05BYMT-T5](#) [MIC2033-12AYMT-T5](#) [MIC2033-05BYM6-T5](#) [SLG5NT1437VTR](#) [SZNCP3712ASNT1G](#) [DML1008LDS-7](#) [KTS1670EDA-TR](#) [KTS1640QGDV-TR](#) [KTS1641QGDV-TR](#) [NCV459MNWTBG](#) [FPF2260ATMX](#) [U6513A](#) [MIC2012YM-TR](#) [NCP45780IMN24RTWG](#) [MAX14919ATP+](#) [MC33882PEP](#) [TPS2104DBVR](#) [MIC2098-1YMT-TR](#) [MIC94062YMT TR](#) [MP6231DN-LF](#) [MIC2015-1.2YM6 TR](#) [MIC2075-2YM](#) [MIC94068YML-TR](#) [SIP32461DB-T2-GE1](#) [NCP335FCT2G](#) [TCK105G,LF\(S](#) [AP2411S-13](#) [AP2151DSG-13](#) [MIC94094YC6-TR](#) [MIC94093YC6-TR](#) [MIC94064YC6-TR](#) [MIC94061YMT-TR](#) [MIC2505-1YM](#) [MIC94305YMT-TR](#) [MIC94085YFT-TR](#) [MIC94081YFT-TR](#) [MIC94042YFL-TR](#) [MIC94041YFL-TR](#) [MIC2005-1.2YM6-TR](#) [TPS2032QDRQ1](#) [NCP333FCT2G](#) [BTS3050TFATMA1](#) [NCP331SNT1G](#) [TPS2092DR](#) [TPS2063DR](#)