



# VNP20N07FI VNB20N07/VNV20N07

## "OMNIFET": FULLY AUTOPROTECTED POWER MOSFET

TYPE	V <sub>clamp</sub>	R <sub>DS(on)</sub>	I <sub>lim</sub>
VNP20N07FI	70 V	0.05 Ω	20 A
VNB20N07	70 V	0.05 Ω	20 A
VNV20N07	70 V	0.05 Ω	20 A

- LINEAR CURRENT LIMITATION
- THERMAL SHUT DOWN
- SHORT CIRCUIT PROTECTION
- INTEGRATED CLAMP
- LOW CURRENT DRAWN FROM INPUT PIN
- DIAGNOSTIC FEEDBACK THROUGH INPUT PIN
- ESD PROTECTION
- DIRECT ACCESS TO THE GATE OF THE POWER MOSFET (ANALOG DRIVING)
- COMPATIBLE WITH STANDARD POWER MOSFET

### DESCRIPTION

The VNP20N07FI, VNB20N07 and VNV20N07 are monolithic devices made using STMicroelectronics VIPower M0 Technology, intended for replacement of standard power MOSFETS in DC to 50 KHz applications. Built-in thermal shut-down, linear current limitation and overvoltage clamp protect the chip in harsh

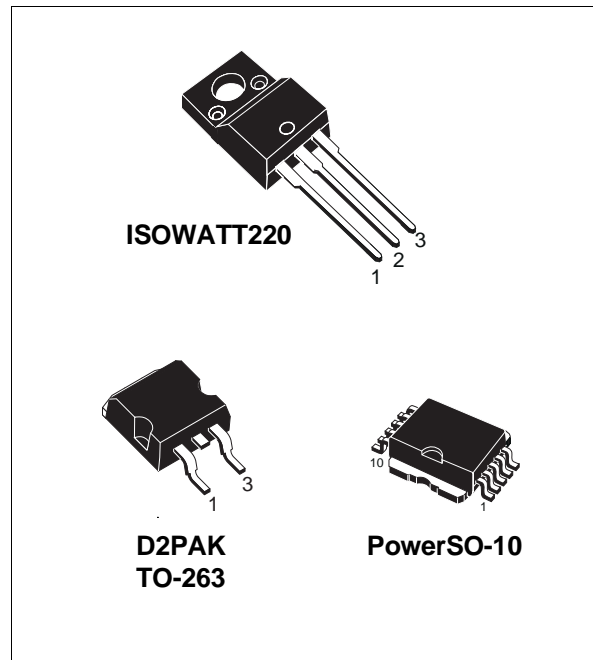

environments.

Fault feedback can be detected by monitoring the voltage at the input pin.

### BLOCK DIAGRAM (\*)

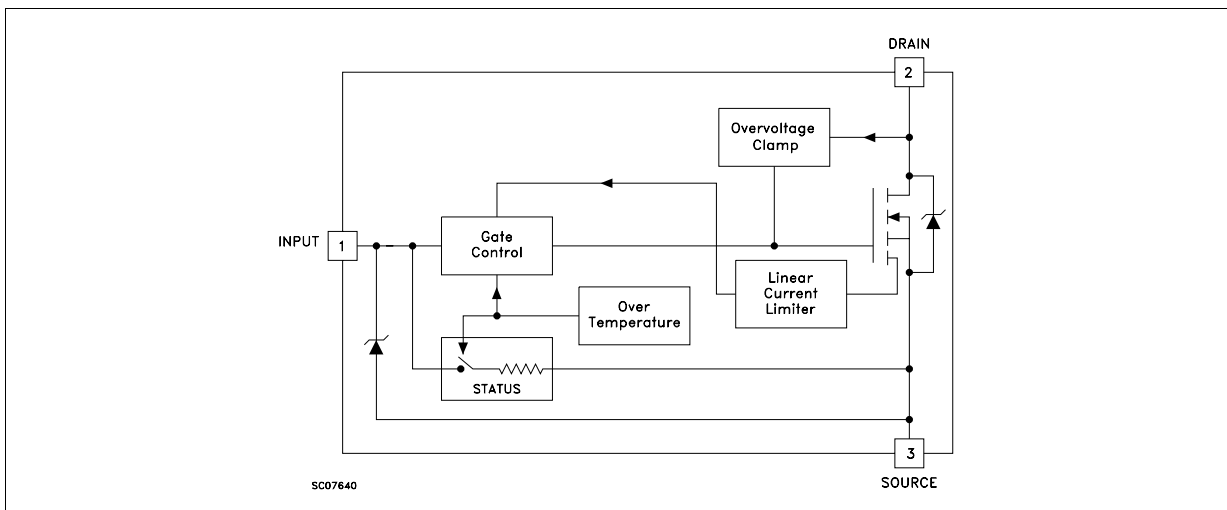

(\*) PowerSO-10 Pin Configuration : INPUT = 6,7,8,9,10; SOURCE = 1,2,4,5; DRAIN = TAB

**ABSOLUTE MAXIMUM RATING**

Symbol	Parameter	Value		Unit
		PowerSO-10 D2PAK	ISOWATT220	
V <sub>DS</sub>	Drain-source Voltage (V <sub>in</sub> = 0)	Internally Clamped		V
V <sub>in</sub>	Input Voltage	18		V
I <sub>D</sub>	Drain Current	Internally Limited		A
I <sub>R</sub>	Reverse DC Output Current	-28		A
V <sub>esd</sub>	Electrostatic Discharge (C= 100 pF, R=1.5 KΩ)	2000		V
P <sub>tot</sub>	Total Dissipation at T <sub>c</sub> = 25 °C	83	34	W
T <sub>j</sub>	Operating Junction Temperature	Internally Limited		°C
T <sub>c</sub>	Case Operating Temperature	Internally Limited		°C
T <sub>stg</sub>	Storage Temperature	-55 to 150		°C

**THERMAL DATA**

		ISOWATT220	PowerSO-10	D2PAK	
R <sub>thj-case</sub>	Thermal Resistance Junction-case Max	3.75	1.5	1.5	°C/W
R <sub>thj-amb</sub>	Thermal Resistance Junction-ambient Max	62.5	50	62.5	°C/W

**ELECTRICAL CHARACTERISTICS** (T<sub>case</sub> = 25 °C unless otherwise specified)

OFF

Symbol	Parameter	Test Conditions	Min.	Typ.	Max.	Unit
V <sub>CLAMP</sub>	Drain-source Clamp Voltage	I <sub>D</sub> = 200 mA V <sub>in</sub> = 0	60	70	80	V
V <sub>CLTH</sub>	Drain-source Clamp Threshold Voltage	I <sub>D</sub> = 2 mA V <sub>in</sub> = 0	55			V
V <sub>INCL</sub>	Input-Source Reverse Clamp Voltage	I <sub>in</sub> = -1 mA	-1		-0.3	V
I <sub>DSS</sub>	Zero Input Voltage Drain Current (V <sub>in</sub> = 0)	V <sub>DS</sub> = 13 V V <sub>in</sub> = 0 V <sub>DS</sub> = 25 V V <sub>in</sub> = 0			50 200	μA μA
I <sub>ISS</sub>	Supply Current from Input Pin	V <sub>DS</sub> = 0 V V <sub>in</sub> = 10 V		250	500	μA

ON (\*)

Symbol	Parameter	Test Conditions	Min.	Typ.	Max.	Unit
V <sub>IN(th)</sub>	Input Threshold Voltage	V <sub>DS</sub> = V <sub>in</sub> I <sub>D</sub> + I <sub>in</sub> = 1 mA	0.8		3	V
R <sub>DS(on)</sub>	Static Drain-source On Resistance	V <sub>in</sub> = 10 V I <sub>D</sub> = 10 A V <sub>in</sub> = 5 V I <sub>D</sub> = 10 A			0.05 0.07	Ω Ω

**DYNAMIC**

Symbol	Parameter	Test Conditions	Min.	Typ.	Max.	Unit
g <sub>fs</sub> (*)	Forward Transconductance	V <sub>DS</sub> = 13 V I <sub>D</sub> = 10 A	13	17		S
C <sub>oss</sub>	Output Capacitance	V <sub>DS</sub> = 13 V f = 1 MHz V <sub>in</sub> = 0		500	800	pF

**ELECTRICAL CHARACTERISTICS** (continued)**SWITCHING (\*\*)**

Symbol	Parameter	Test Conditions	Min.	Typ.	Max.	Unit
$t_{d(on)}$	Turn-on Delay Time	$V_{DD} = 15\text{ V}$ $I_d = 10\text{ A}$		90	180	ns
$t_r$	Rise Time	$V_{gen} = 10\text{ V}$ $R_{gen} = 10\ \Omega$		240	400	ns
$t_{d(off)}$	Turn-off Delay Time	(see figure 3)		430	800	ns
$t_f$	Fall Time			150	300	ns
$t_{d(on)}$	Turn-on Delay Time	$V_{DD} = 15\text{ V}$ $I_d = 10\text{ A}$		800	1200	ns
$t_r$	Rise Time	$V_{gen} = 10\text{ V}$ $R_{gen} = 1000\ \Omega$		1.5	2.2	$\mu\text{s}$
$t_{d(off)}$	Turn-off Delay Time	(see figure 3)		6	10	$\mu\text{s}$
$t_f$	Fall Time			3.5	5.5	$\mu\text{s}$
$(di/dt)_{on}$	Turn-on Current Slope	$V_{DD} = 15\text{ V}$ $I_D = 10\text{ A}$ $V_{in} = 10\text{ V}$ $R_{gen} = 10\ \Omega$		60		A/ $\mu\text{s}$
$Q_i$	Total Input Charge	$V_{DD} = 12\text{ V}$ $I_D = 10\text{ A}$ $V_{in} = 10\text{ V}$		60		nC

**SOURCE DRAIN DIODE**

Symbol	Parameter	Test Conditions	Min.	Typ.	Max.	Unit
$V_{SD} (*)$	Forward On Voltage	$I_{SD} = 10\text{ A}$ $V_{in} = 0$			1.6	V
$t_{rr}(**)$	Reverse Recovery Time	$I_{SD} = 10\text{ A}$ $di/dt = 100\text{ A}/\mu\text{s}$ $V_{DD} = 30\text{ V}$ $T_j = 25\text{ }^\circ\text{C}$		165		ns
$Q_{rr}(**)$	Reverse Recovery Charge	(see test circuit, figure 5)		0.55		$\mu\text{C}$
$I_{RRM}(**)$	Reverse Recovery Current			6.5		A

**PROTECTION**

Symbol	Parameter	Test Conditions	Min.	Typ.	Max.	Unit
$I_{lim}$	Drain Current Limit	$V_{in} = 10\text{ V}$ $V_{DS} = 13\text{ V}$ $V_{in} = 5\text{ V}$ $V_{DS} = 13\text{ V}$	14 14	20 20	28 28	A A
$t_{dim}(**)$	Step Response Current Limit	$V_{in} = 10\text{ V}$ $V_{in} = 5\text{ V}$		29 70	60 140	$\mu\text{s}$ $\mu\text{s}$
$T_{jsh}(**)$	Overtemperature Shutdown		150			$^\circ\text{C}$
$T_{jrs}(**)$	Overtemperature Reset		135			$^\circ\text{C}$
$I_{gf}(**)$	Fault Sink Current	$V_{in} = 10\text{ V}$ $V_{in} = 5\text{ V}$		50 20		mA mA
$E_{as}(**)$	Single Pulse Avalanche Energy	starting $T_j = 25\text{ }^\circ\text{C}$ $V_{DD} = 20\text{ V}$ $V_{in} = 10\text{ V}$ $R_{gen} = 1\text{ K}\Omega$ $L = 10\text{ mH}$	0.95			J

(\*) Pulsed: Pulse duration = 300  $\mu\text{s}$ , duty cycle 1.5 %

(\*\*) Parameters guaranteed by design/characterization

### PROTECTION FEATURES

During normal operation, the Input pin is electrically connected to the gate of the internal power MOSFET. The device then behaves like a standard power MOSFET and can be used as a switch from DC to 50 KHz. The only difference from the user's standpoint is that a small DC current ( $I_{ISS}$ ) flows into the Input pin in order to supply the internal circuitry.

The device integrates:

- **OVERVOLTAGE CLAMP PROTECTION:** internally set at 70V, along with the rugged avalanche characteristics of the Power MOSFET stage give this device unrivalled ruggedness and energy handling capability. This feature is mainly important when driving inductive loads.
- **LINEAR CURRENT LIMITER CIRCUIT:** limits the drain current  $I_d$  to  $I_{lim}$  whatever the Input pin voltage. When the current limiter is active, the device operates in the linear region, so power dissipation may exceed the capability of the heatsink. Both case and junction temperatures increase, and if this phase lasts long enough, junction temperature may reach the overtemperature threshold  $T_{jsh}$ .

- **OVERTEMPERATURE AND SHORT CIRCUIT PROTECTION:** these are based on sensing the chip temperature and are not dependent on the input voltage. The location of the sensing element on the chip in the power stage area ensures fast, accurate detection of the junction temperature. Overtemperature cutout occurs at minimum 150°C. The device is automatically restarted when the chip temperature falls below 135°C.
- **STATUS FEEDBACK:** In the case of an overtemperature fault condition, a Status Feedback is provided through the Input pin. The internal protection circuit disconnects the input from the gate and connects it instead to ground via an equivalent resistance of 100  $\Omega$ . The failure can be detected by monitoring the voltage at the Input pin, which will be close to ground potential.

Additional features of this device are ESD protection according to the Human Body model and the ability to be driven from a TTL Logic circuit (with a small increase in  $R_{DS(on)}$ ).

Thermal Impedance For ISOWATT220

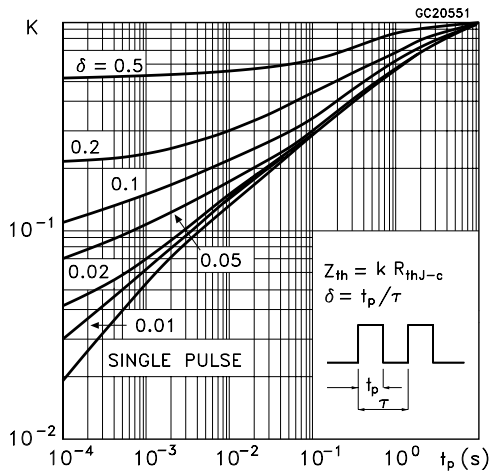

Thermal Impedance For D2PAK / PowerSO-10



Derating Curve



Output Characteristics

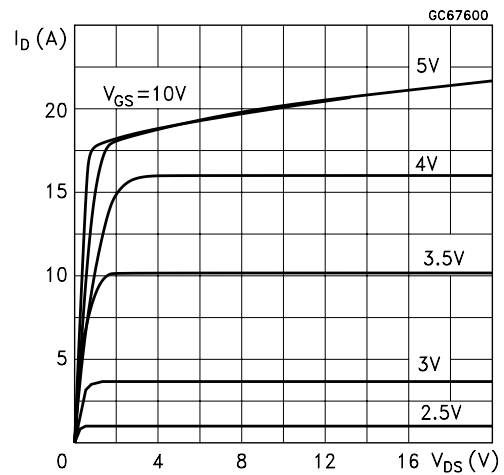

Transconductance



Static Drain-Source On Resistance vs Input Voltage

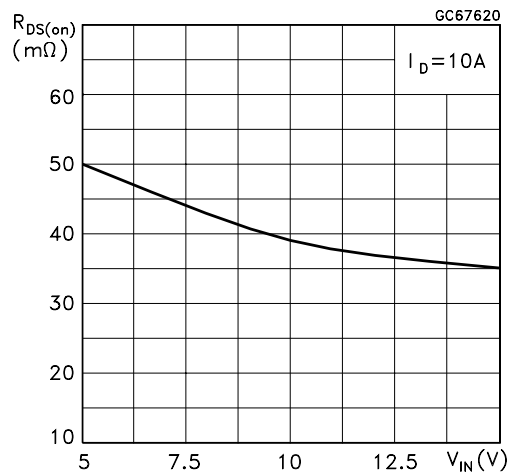

Static Drain-Source On Resistance

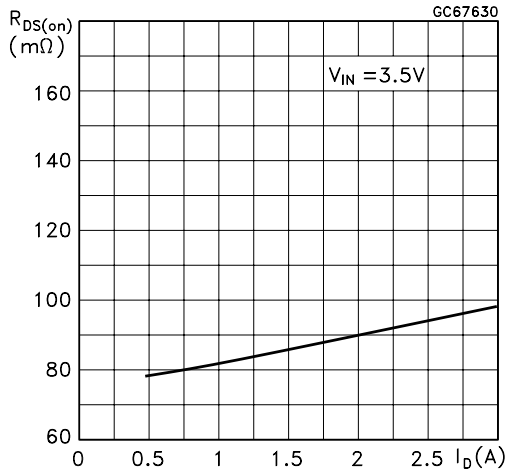

Static Drain-Source On Resistance

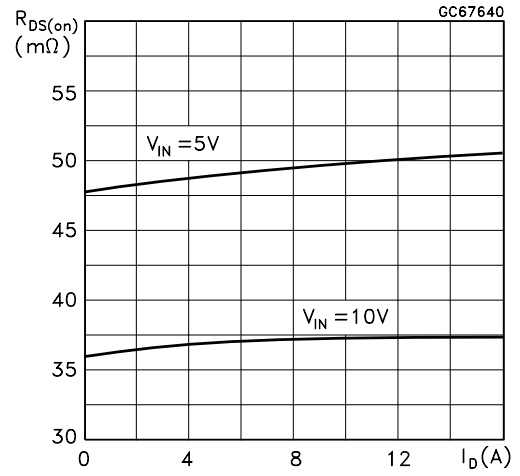

Input Charge vs Input Voltage

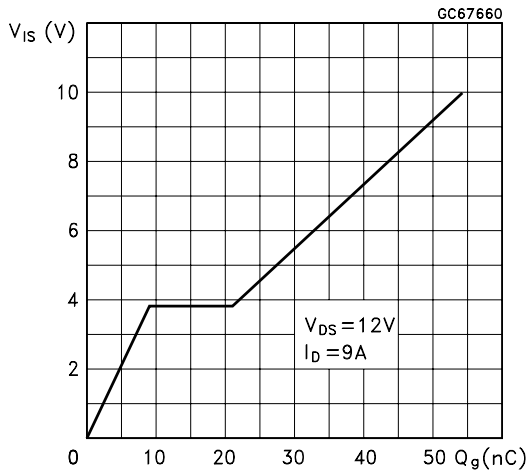

Capacitance Variations

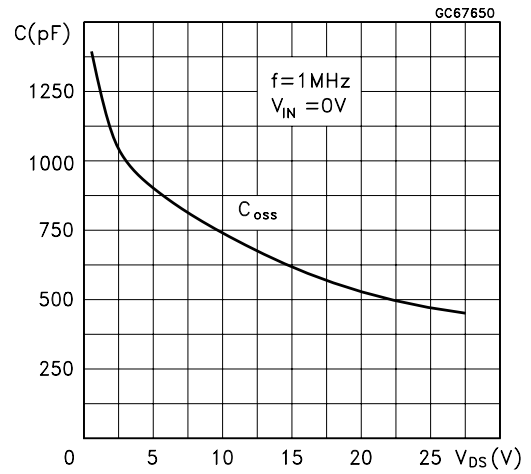

Normalized Input Threshold Voltage vs Temperature

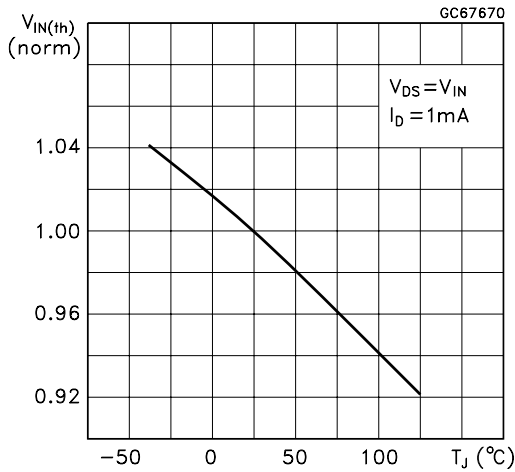

Normalized On Resistance vs Temperature

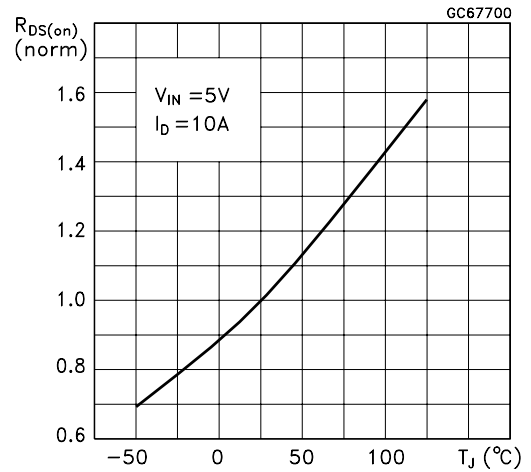

Normalized On Resistance vs Temperature



Turn-on Current Slope

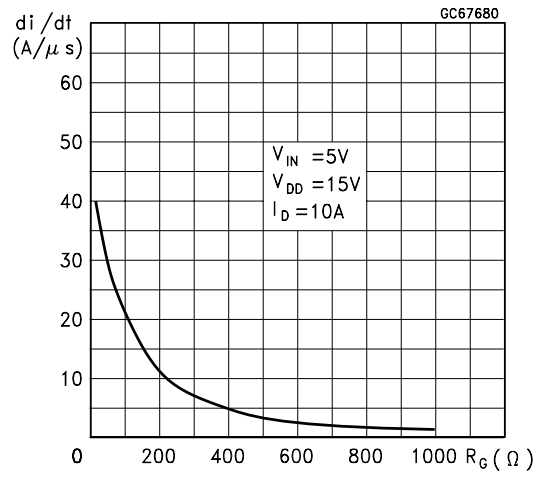

Turn-on Current Slope



Turn-off Drain-Source Voltage Slope

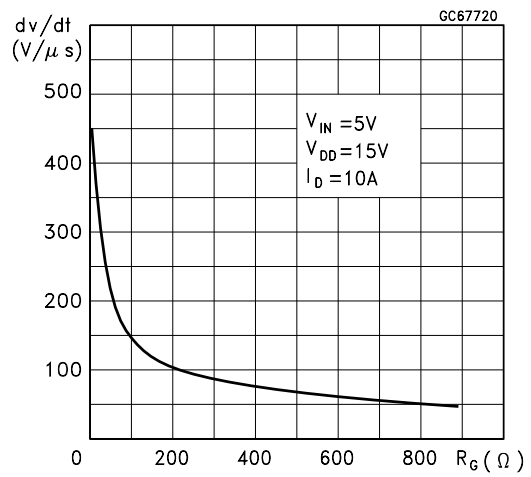

Turn-off Drain-Source Voltage Slope



Switching Time Resistive Load

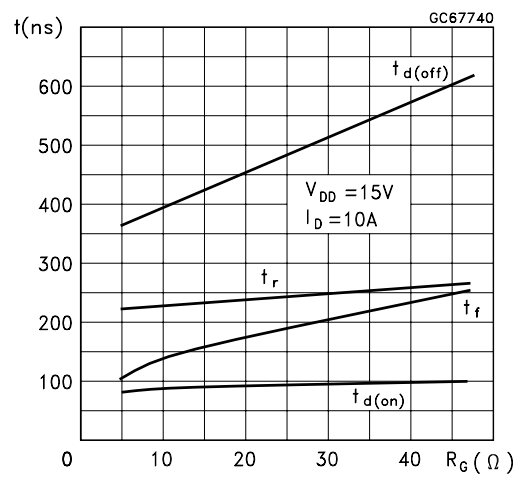

Switching Time Resistive Load

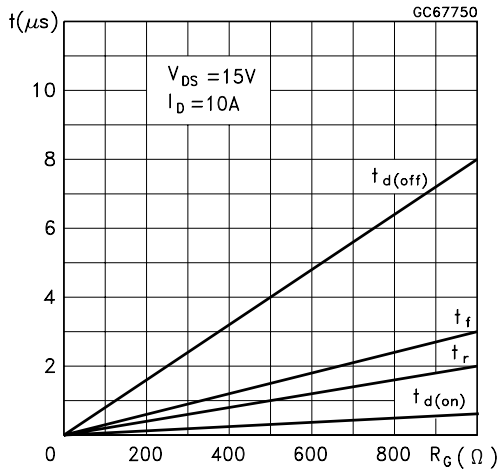

Switching Time Resistive Load

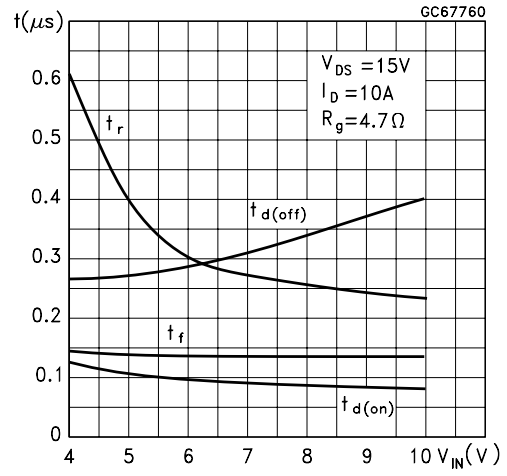

Current Limit vs Junction Temperature

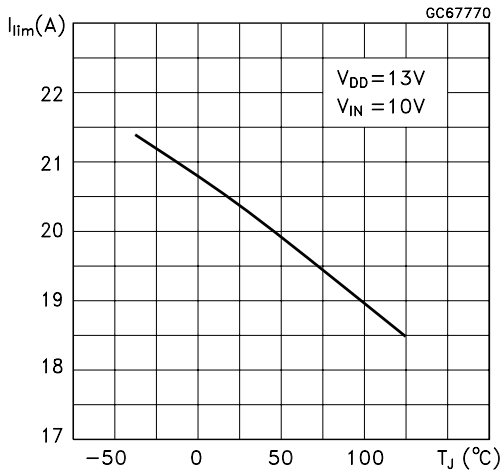

Step Response Current Limit



Source Drain Diode Forward Characteristics

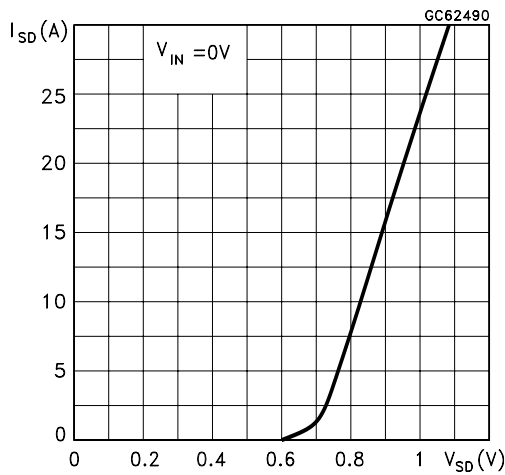



**Fig. 1: Unclamped Inductive Load Test Circuits**



**Fig. 2: Unclamped Inductive Waveforms**



**Fig. 3: Switching Times Test Circuits For Resistive Load**



**Fig. 4: Input Charge Test Circuit**



**Fig. 5: Test Circuit For Inductive Load Switching And Diode Recovery Times**

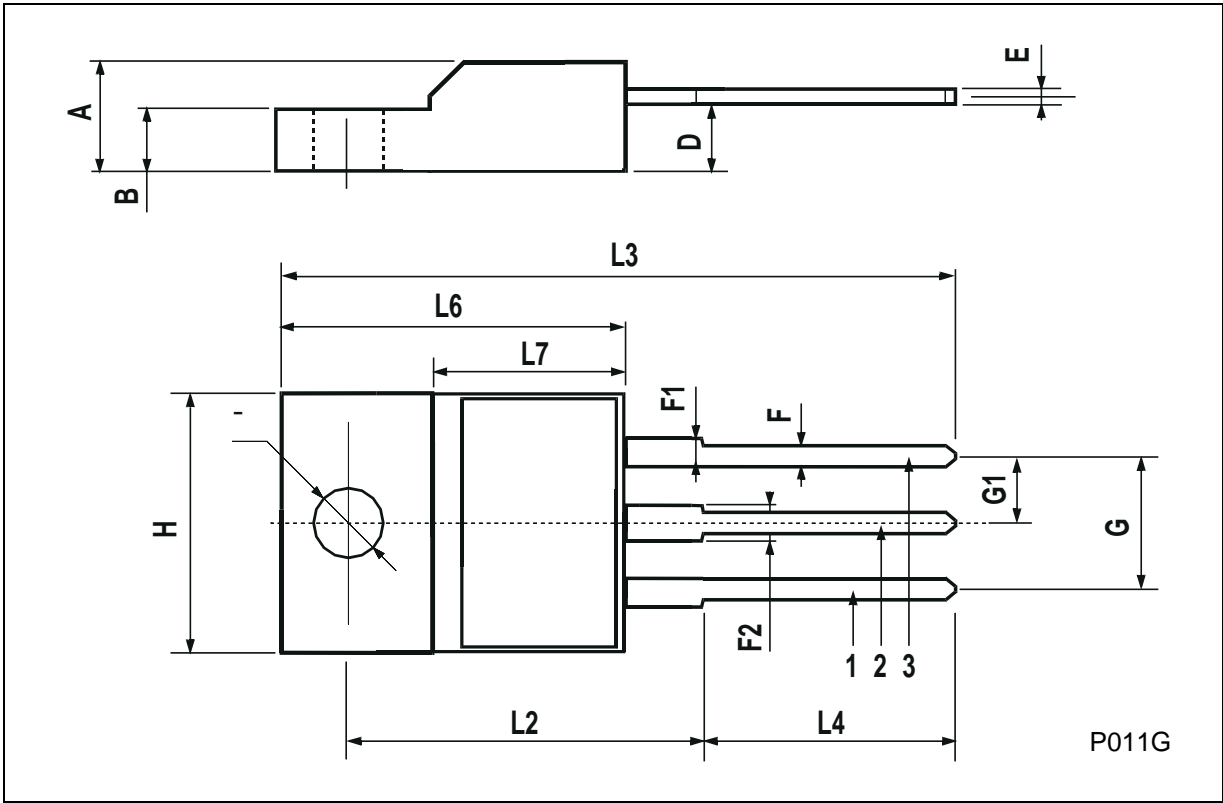

**Fig. 6: Waveforms**



**ISOWATT220 MECHANICAL DATA**

DIM.	mm			inch		
	MIN.	TYP.	MAX.	MIN.	TYP.	MAX.
A	4.4		4.6	0.173		0.181
B	2.5		2.7	0.098		0.106
D	2.5		2.75	0.098		0.108
E	0.4		0.7	0.015		0.027
F	0.75		1	0.030		0.039
F1	1.15		1.7	0.045		0.067
F2	1.15		1.7	0.045		0.067
G	4.95		5.2	0.195		0.204
G1	2.4		2.7	0.094		0.106
H	10		10.4	0.393		0.409
L2		16			0.630	
L3	28.6		30.6	1.126		1.204
L4	9.8		10.6	0.385		0.417
L6	15.9		16.4	0.626		0.645
L7	9		9.3	0.354		0.366
Ø	3		3.2	0.118		0.126



**TO-263 (D2PAK) MECHANICAL DATA**

DIM.	mm			inch		
	MIN.	TYP.	MAX.	MIN.	TYP.	MAX.
A	4.3		4.6	0.169		0.181
A1	2.49		2.69	0.098		0.106
B	0.7		0.93	0.027		0.036
B2	1.25		1.4	0.049		0.055
C	0.45		0.6	0.017		0.023
C2	1.21		1.36	0.047		0.053
D	8.95		9.35	0.352		0.368
E	10		10.28	0.393		0.404
G	4.88		5.28	0.192		0.208
L	15		15.85	0.590		0.624
L2	1.27		1.4	0.050		0.055
L3	1.4		1.75	0.055		0.068



**PowerSO-10 MECHANICAL DATA**

DIM.	mm			inch		
	MIN.	TYP.	MAX.	MIN.	TYP.	MAX.
A	3.35		3.65	0.132		0.144
A1	0.00		0.10	0.000		0.004
B	0.40		0.60	0.016		0.024
c	0.35		0.55	0.013		0.022
D	9.40		9.60	0.370		0.378
D1	7.40		7.60	0.291		0.300
E	9.30		9.50	0.366		0.374
E1	7.20		7.40	0.283		0.291
E2	7.20		7.60	0.283		0.300
E3	6.10		6.35	0.240		0.250
E4	5.90		6.10	0.232		0.240
e		1.27			0.050	
F	1.25		1.35	0.049		0.053
H	13.80		14.40	0.543		0.567
h		0.50			0.002	
L	1.20		1.80	0.047		0.071
q		1.70			0.067	
$\alpha$	0°		8°			



**Please Read Carefully:**

Information in this document is provided solely in connection with ST products. STMicroelectronics NV and its subsidiaries ("ST") reserve the right to make changes, corrections, modifications or improvements, to this document, and the products and services described herein at any time, without notice.

All ST products are sold pursuant to ST's terms and conditions of sale.

Purchasers are solely responsible for the choice, selection and use of the ST products and services described herein, and ST assumes no liability whatsoever relating to the choice, selection or use of the ST products and services described herein.

No license, express or implied, by estoppel or otherwise, to any intellectual property rights is granted under this document. If any part of this document refers to any third party products or services it shall not be deemed a license grant by ST for the use of such third party products or services, or any intellectual property contained therein or considered as a warranty covering the use in any manner whatsoever of such third party products or services or any intellectual property contained therein.

**UNLESS OTHERWISE SET FORTH IN ST'S TERMS AND CONDITIONS OF SALE ST DISCLAIMS ANY EXPRESS OR IMPLIED WARRANTY WITH RESPECT TO THE USE AND/OR SALE OF ST PRODUCTS INCLUDING WITHOUT LIMITATION IMPLIED WARRANTIES OF MERCHANTABILITY, FITNESS FOR A PARTICULAR PURPOSE (AND THEIR EQUIVALENTS UNDER THE LAWS OF ANY JURISDICTION), OR INFRINGEMENT OF ANY PATENT, COPYRIGHT OR OTHER INTELLECTUAL PROPERTY RIGHT.**

**ST PRODUCTS ARE NOT DESIGNED OR AUTHORIZED FOR USE IN: (A) SAFETY CRITICAL APPLICATIONS SUCH AS LIFE SUPPORTING, ACTIVE IMPLANTED DEVICES OR SYSTEMS WITH PRODUCT FUNCTIONAL SAFETY REQUIREMENTS; (B) AERONAUTIC APPLICATIONS; (C) AUTOMOTIVE APPLICATIONS OR ENVIRONMENTS, AND/OR (D) AEROSPACE APPLICATIONS OR ENVIRONMENTS. WHERE ST PRODUCTS ARE NOT DESIGNED FOR SUCH USE, THE PURCHASER SHALL USE PRODUCTS AT PURCHASER'S SOLE RISK, EVEN IF ST HAS BEEN INFORMED IN WRITING OF SUCH USAGE, UNLESS A PRODUCT IS EXPRESSLY DESIGNATED BY ST AS BEING INTENDED FOR "AUTOMOTIVE, AUTOMOTIVE SAFETY OR MEDICAL" INDUSTRY DOMAINS ACCORDING TO ST PRODUCT DESIGN SPECIFICATIONS. PRODUCTS FORMALLY ESCC, QML OR JAN QUALIFIED ARE DEEMED SUITABLE FOR USE IN AEROSPACE BY THE CORRESPONDING GOVERNMENTAL AGENCY.**

Resale of ST products with provisions different from the statements and/or technical features set forth in this document shall immediately void any warranty granted by ST for the ST product or service described herein and shall not create or extend in any manner whatsoever, any liability of ST.

ST and the ST logo are trademarks or registered trademarks of ST in various countries.

Information in this document supersedes and replaces all information previously supplied.

The ST logo is a registered trademark of STMicroelectronics. All other names are the property of their respective owners.

© 2013 STMicroelectronics - All rights reserved

STMicroelectronics group of companies

Australia - Belgium - Brazil - Canada - China - Czech Republic - Finland - France - Germany - Hong Kong - India - Israel - Italy - Japan - Malaysia - Malta - Morocco - Philippines - Singapore - Spain - Sweden - Switzerland - United Kingdom - United States of America

[www.st.com](http://www.st.com)



## X-ON Electronics

Largest Supplier of Electrical and Electronic Components

*Click to view similar products for* [Power Switch ICs - Power Distribution](#) *category:*

*Click to view products by* [STMicroelectronics](#) *manufacturer:*

Other Similar products are found below :

[TCK111G,LF\(S](#) [FPF1018](#) [DS1222](#) [TCK2065G,LF](#) [SZNCP3712ASNT3G](#) [MIC2033-05BYMT-T5](#) [MIC2033-12AYMT-T5](#) [MIC2033-05BYM6-T5](#) [SLG5NT1437VTR](#) [SZNCP3712ASNT1G](#) [DML1008LDS-7](#) [KTS1670EDA-TR](#) [KTS1640QGDV-TR](#) [KTS1641QGDV-TR](#) [NCV459MNWTBG](#) [FPF2260ATMX](#) [U6513A](#) [MIC2012YM-TR](#) [NCP45780IMN24RTWG](#) [MAX14919ATP+](#) [MC33882PEP](#) [TPS2104DBVR](#) [MIC2098-1YMT-TR](#) [MIC94062YMT TR](#) [MP6231DN-LF](#) [MIC2015-1.2YM6 TR](#) [MIC2075-2YM](#) [MIC94068YML-TR](#) [SIP32461DB-T2-GE1](#) [NCP335FCT2G](#) [TCK105G,LF\(S](#) [AP2411S-13](#) [AP2151DSG-13](#) [MIC94094YC6-TR](#) [MIC94093YC6-TR](#) [MIC94064YC6-TR](#) [MIC94061YMT-TR](#) [MIC2505-1YM](#) [MIC94305YMT-TR](#) [MIC94085YFT-TR](#) [MIC94081YFT-TR](#) [MIC94042YFL-TR](#) [MIC94041YFL-TR](#) [MIC2005-1.2YM6-TR](#) [TPS2032QDRQ1](#) [NCP333FCT2G](#) [BTS3050TFATMA1](#) [NCP331SNT1G](#) [TPS2092DR](#) [TPS2063DR](#)