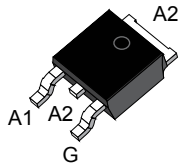

## 4 A - Triac in DPAK package

**DPAK**

### Features

- 4 A Triac
- $V_{DRM} / V_{RRM} = 600 \text{ V}$  and  $V_{DSM} / V_{RSM} = 750 \text{ V}$
- 125 °C maximum junction temperature  $T_j$
- DPAK package
- 4 quadrants triacs with  $I_{GT} = 3 \text{ mA}$
- Halogen-free molding, lead-free plating
- ECOPACK2 compliant

### Applications

- Actuators
- Heating elements
- Inrush current limiting circuits

#### Product status link

[Z0402MB](#)

#### Product summary

$I_{T(RMS)}$	4 A
$V_{DSM}/V_{RSM}$	750 V
$I_{GT}$	3 mA
$T_j \text{ max.}$	125 °C

### Description

The Z0402MB series is 4 A Triac housed in compact SMD DPAK. This 4 quadrants device is suited to home appliances or power tools and industrial systems and drives loads up to 4 A.

# 1 Characteristics

**Table 1. Absolute maximum ratings (limiting values)**

Symbol	Parameter	Value	Unit
$I_{T(RMS)}$	RMS on-state current (full sine wave)	$T_c = 107\text{ }^\circ\text{C}$	4 A
$I_{TSM}$	Non repetitive surge peak on-state current (full cycle, $T_j$ initial = $25\text{ }^\circ\text{C}$ )	$t = 16.7\text{ ms}$	16 A
		$t = 20\text{ ms}$	15
$I^2t$	$I^2t$ value for fusing	$t_p = 10\text{ ms}$	1.5 $\text{A}^2\text{s}$
$di/dt$	Critical rate of rise of on-state current, $I_G = 2 \times I_{GT}$ , $t_r \leq 100\text{ ns}$ , $f = 120\text{ Hz}$	$T_j = 125\text{ }^\circ\text{C}$	50 $\text{A}/\mu\text{s}$
$V_{DRM}/V_{RRM}$	Repetitive peak off-state voltage	$T_j = 125\text{ }^\circ\text{C}$	600 V
$V_{DSM}/V_{RSM}$	Non Repetitive peak off-state voltage, 10 ms		750 V
$I_{GM}$	Maximum peak gate current	$t_p = 20\text{ }\mu\text{s}$ , $T_j = 125\text{ }^\circ\text{C}$	1.2 A
$P_{GM}$	Maximum gate power dissipation		0.5 W
$T_{stg}$	Storage temperature range		-40 to +125 $^\circ\text{C}$
$T_j$	Operating junction temperature range		-40 to +125 $^\circ\text{C}$
$T_L$	Maximum lead temperature for soldering during 10 s		260 $^\circ\text{C}$

**Table 2. Electrical characteristics ( $T_j = 25\text{ }^\circ\text{C}$ , unless otherwise specified)**

Symbol	Test conditions	Value	Unit	
$I_{GT}^{(1)}$	$V_D = 12\text{ V}$ , $R_L = 33\text{ }\Omega$	Max.	3 mA	
$V_{GT}$	$V_D = 12\text{ V}$ , $R_L = 33\text{ }\Omega$	Max.	1.3 V	
$V_{GD}$	$V_D = V_{DRM}$ , $R_L = 3.3\text{ k}\Omega$	$T_j = 125\text{ }^\circ\text{C}$ Min.	0.2 V	
$I_L$	$I_G = 1.2 \times I_{GT}$	I-III-IV	Max.	10 mA
		II	Max.	15 mA
$I_H^{(2)}$	$I_T = 500\text{ mA}$ , gate open	Max.	5 mA	
$dV/dt^{(2)}$	$V_D = 67\% V_{DRM}$ ; $V_R = 67\% V_{RRM}$ , gate open	$T_j = 110\text{ }^\circ\text{C}$ Min.	20 $\text{V}/\mu\text{s}$	
$(dV/dt)_c^{(2)}$	$(di/dt)_c = 1.8\text{ A/ms}$	$T_j = 110\text{ }^\circ\text{C}$ Min.	0.5 $\text{V}/\mu\text{s}$	

1. For both polarities of OUT pin referenced to COM pin.

2. For both polarities of A2 referenced to A1.

**Table 3. Static characteristics**

Symbol	Test conditions	$T_j$	Value	Unit
$V_{TM}^{(1)}$	$I_{TM} = 5.5\text{ A}$ , $t_p = 380\text{ }\mu\text{s}$	$25\text{ }^\circ\text{C}$	Max.	2 V
$V_{TO}^{(1)}$	Threshold voltage	$125\text{ }^\circ\text{C}$	Max.	0.95 V
$R_D^{(1)}$	Dynamic resistance	$125\text{ }^\circ\text{C}$	Max.	180 $\text{m}\Omega$
$I_{DRM}/I_{RRM}$	$V_D = V_R = V_{DRM} = V_{RRM}$	$25\text{ }^\circ\text{C}$	Max.	5 $\mu\text{A}$
		$125\text{ }^\circ\text{C}$		0.5 mA

1. For both polarities of A2 referenced to A1.

**Table 4. Thermal resistance**

Symbol	Parameter		Value	Unit
$R_{th(j-c)}$	Junction to case (AC)	Max.	3	°C/W
$R_{th(j-a)}$	Junction to ambient: $S_{CU} = 0.5 \text{ cm}^2$	Typ.	70	°C/W

## 1.1 Characteristics (curves)

**Figure 1. Maximum power dissipation versus on-state RMS current (full cycle)**

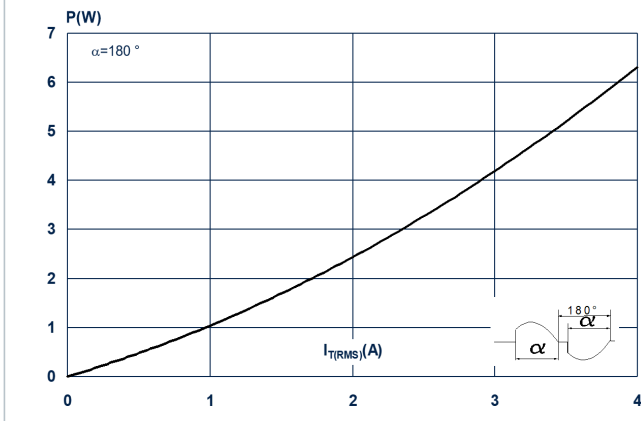

**Figure 2. Average and DC on-state current versus case temperature**

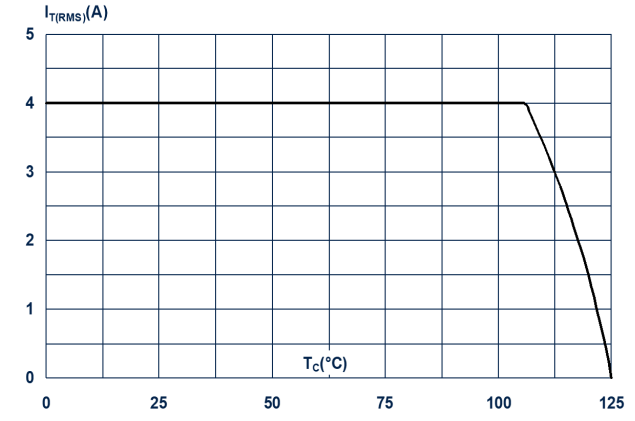

**Figure 3. On-state RMS current versus ambient temperature (full cycle)**

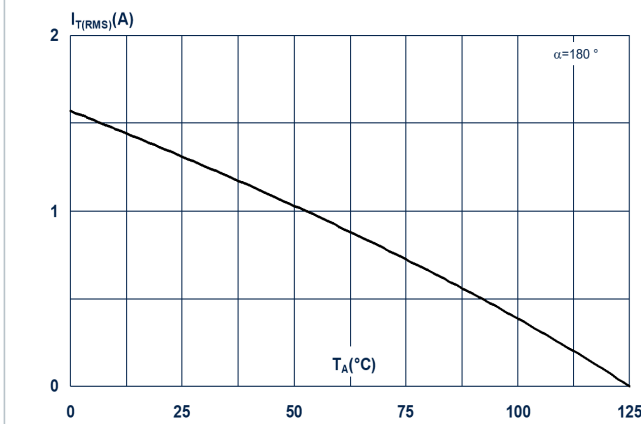

**Figure 4. Relative variation of thermal impedance versus pulse duration**

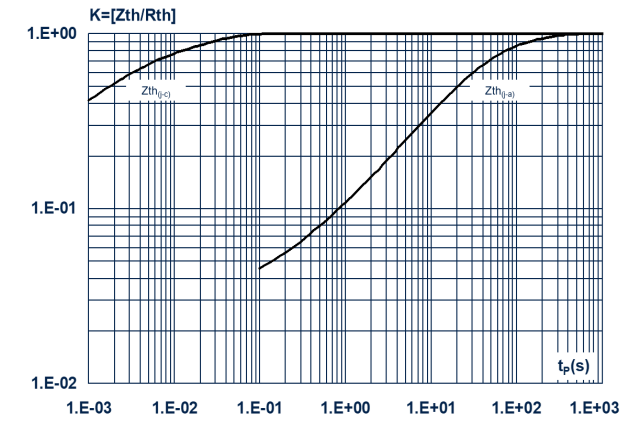

**Figure 5. Relative variation of gate triggering current and voltage versus junction temperature (typical values)**

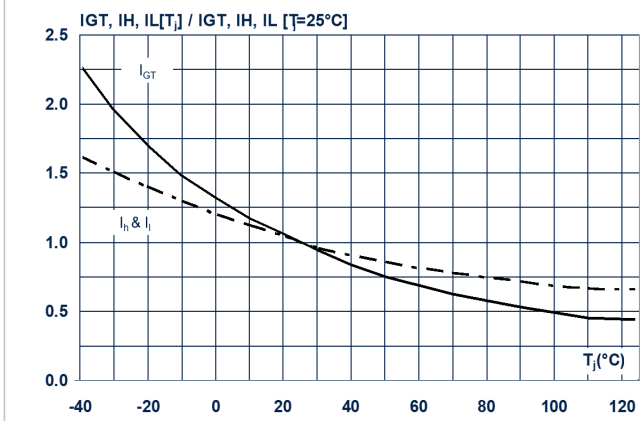

**Figure 6. Surge peak on-state current versus number of cycles**

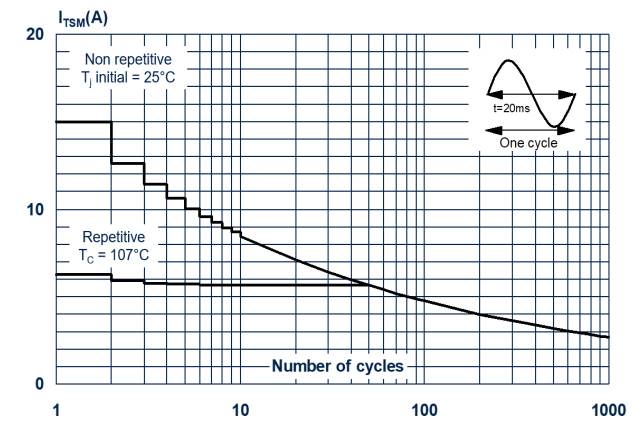

**Figure 7. Non repetitive surge peak on-state current for a sinusoidal pulse with width  $t_p < 10$  ms and corresponding value of  $I^2t$**

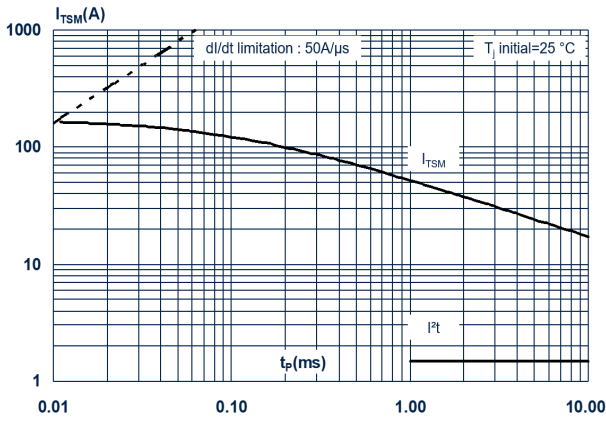

**Figure 8. On-state characteristics (maximum values)**

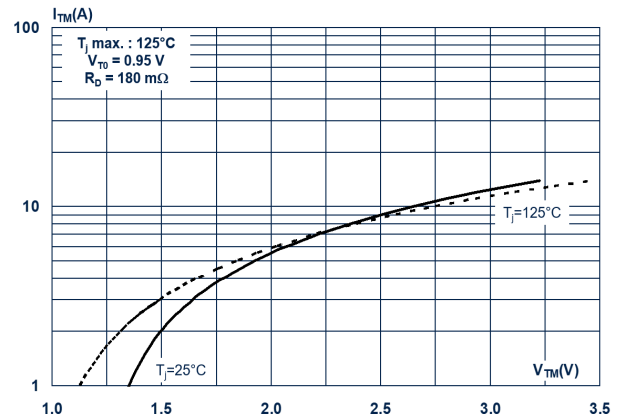

**Figure 9. Relative variation of critical rate of decrease of main current versus  $(dV/dt)_c$  (typical values)**

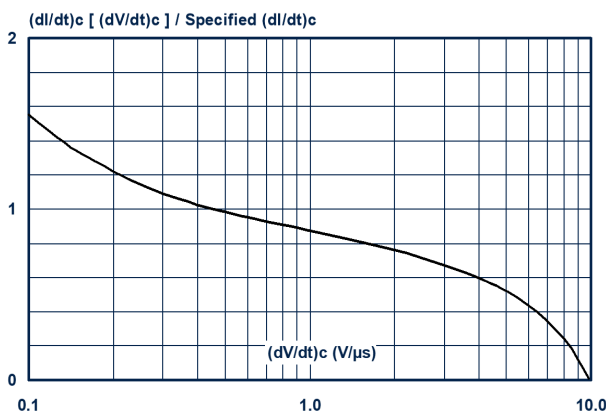

**Figure 10. Relative variation of critical rate of decrease of main current versus junction temperature**

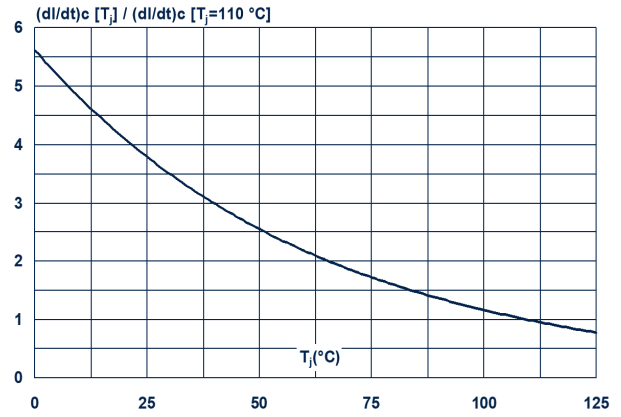

**Figure 11. Relative variation of static  $dV/dt$  immunity versus junction temperature**

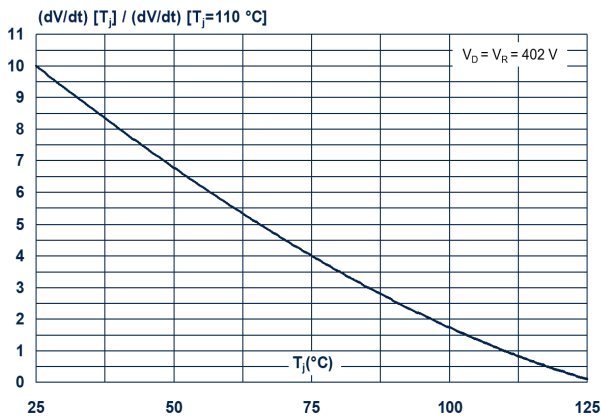

**Figure 12. Thermal resistance junction to ambient versus copper surface under tab (typical values)**

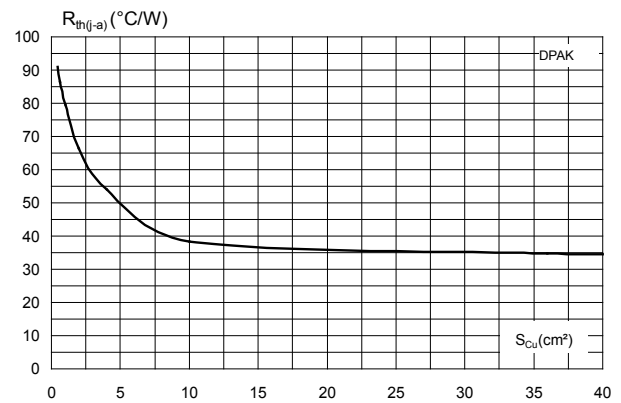

## 2 Package information

In order to meet environmental requirements, ST offers these devices in different grades of **ECOPACK** packages, depending on their level of environmental compliance. ECOPACK specifications, grade definitions and product status are available at: [www.st.com](http://www.st.com). ECOPACK is an ST trademark.

### 2.1 DPAK package information

- Molding compounded resin is halogen free and meets UL94 flammability standard, level V0
- Lead-free package leads plating

Figure 13. DPAK package outline

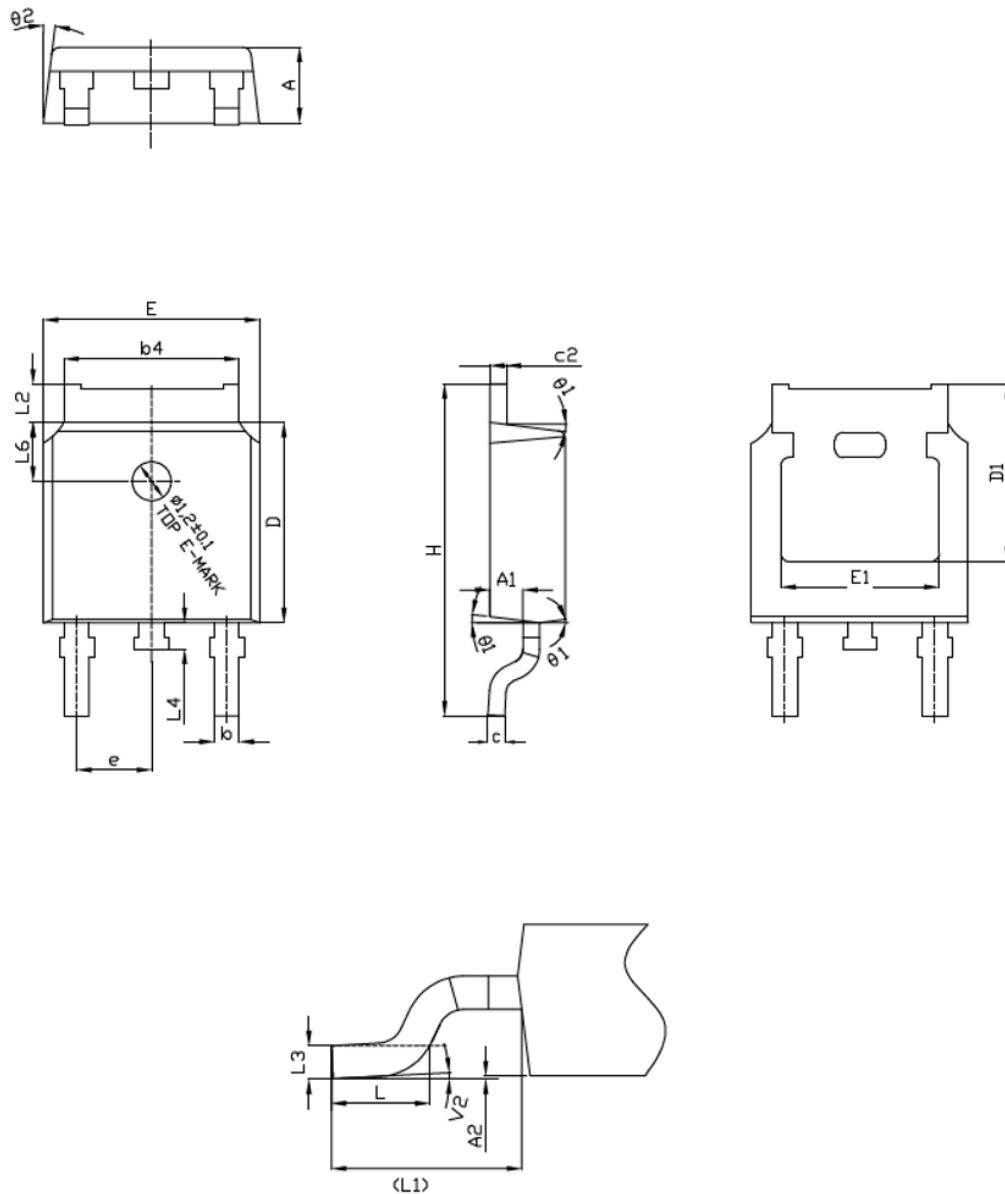

**Table 5. DPAK package mechanical data**

Ref.	Dimensions					
	Millimeters			Inches <sup>(1)</sup>		
	Min.	Typ.	Max.	Min.	Typ.	Max.
A	2.20	2.30	2.38	0.0866	0.0906	0.0937
A1	0.90	1.01	1.10	0.0354	0.0398	0.0433
A2	0.00		0.10	0.0000		0.0039
b	0.72		0.85	0.0283		0.335
b4	5.13	5.33	5.46	0.2020	0.2098	0.2150
c	0.47		0.60	0.0185		0.0236
c2	0.47		0.60	0.0185		0.0236
D	6.00	6.10	6.20	0.2362	0.2402	0.2441
D1	5.15	5.40	5.65	0.2028	0.2126	0.2224
E	6.50	6.60	6.70	0.2550	0.2598	0.2638
E1	4.70	4.85	5.00	0.1850	0.1909	0.1969
e	2.186	2.286	2.386	0.0860	0.0900	0.0940
H	9.80	10.10	10.40	0.3858	0.3976	0.4094
L	1.40	1.50	1.70	0.0551	0.0591	0.0669
L1	2.90 REF			0.1142 REF		
L2	0.90		1.25	0.0354		0.0492
L3	0.51 BSC			0.201 BSC		
L4	0.60	0.80	1.00	0.0236	0.0315	0.0394
L6	1.80 BSC			0.0709 BSC		
Θ1	5°	7°	9°	5°	7°	9°
Θ2	5°	7°	9°	5°	7°	9°
V2	0°		8°	0°		8°

1. Dimensions in inches are given for reference only

**Note:** This package drawing may slightly differ from the physical package. However, all the specified dimensions are guaranteed.

Figure 14. DPAK recommended footprint (dimensions are in mm)

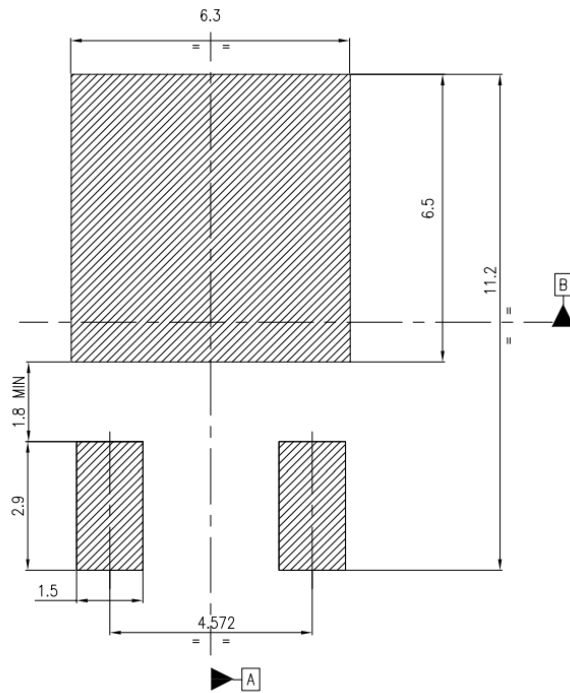



### 3 Ordering information

Figure 15. Ordering information scheme

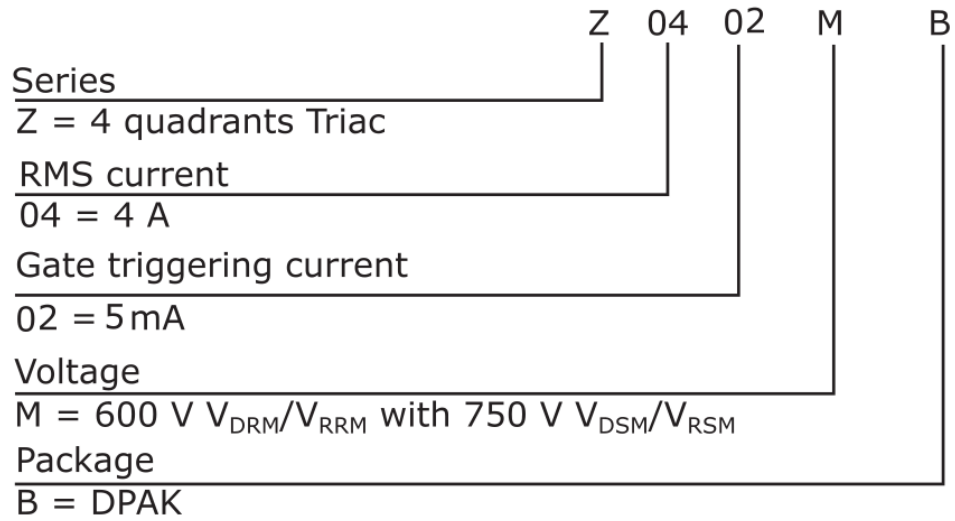

Table 6. Ordering information

Order code	Marking	Package	Weight	Base qty.	Delivery mode
Z0402MB	Z0402MB	DPAK	0.3 g	2500	Tape and reel

---

## Revision history

**Table 7. Document revision history**

Date	Revision	Changes
02-Sep-2022	1	Initial release.

**IMPORTANT NOTICE – READ CAREFULLY**

STMicroelectronics NV and its subsidiaries (“ST”) reserve the right to make changes, corrections, enhancements, modifications, and improvements to ST products and/or to this document at any time without notice. Purchasers should obtain the latest relevant information on ST products before placing orders. ST products are sold pursuant to ST’s terms and conditions of sale in place at the time of order acknowledgment.

Purchasers are solely responsible for the choice, selection, and use of ST products and ST assumes no liability for application assistance or the design of purchasers’ products.

No license, express or implied, to any intellectual property right is granted by ST herein.

Resale of ST products with provisions different from the information set forth herein shall void any warranty granted by ST for such product.

ST and the ST logo are trademarks of ST. For additional information about ST trademarks, refer to [www.st.com/trademarks](http://www.st.com/trademarks). All other product or service names are the property of their respective owners.

Information in this document supersedes and replaces information previously supplied in any prior versions of this document.

© 2022 STMicroelectronics – All rights reserved

## X-ON Electronics

Largest Supplier of Electrical and Electronic Components

*Click to view similar products for [Triacs](#) category:*

*Click to view products by [STMicroelectronics](#) manufacturer:*

Other Similar products are found below :

[BT137-600-0Q](#) [2N6075A](#) [NTE5688](#) [D31410](#) [ACS102-5T1](#) [ACS102-5TA](#) [MAC97A4G](#) [Z0107MAG](#) [Z0107MARL1G](#) [Z0109MARLRPG](#)  
[BTA316-800ET,127](#) [BTA316-800CTQ](#) [ACTT8X-800CTNQ](#) [MCR22-6G](#) [BT138-600E](#) [BTA24-600CWRG](#) [BTA16-800CWRG](#) [BT138-600E](#)  
[BTA08-800CW](#) [BTB24-800CW](#) [BTA16-800CW](#) [BTA16-600CW](#) [FT10050-12P](#) [BT151S-600R](#) [BT136-800E](#) [BT136S](#) [PCR606J](#) [CT404D-](#)  
[800S](#) [JST24A-800CW](#) [JST60IS-1600BW](#) [TYN810RG-JSM](#) [TYN812RG-JSM](#) [BT152-800R](#) [BTB16-800BRG-JSM](#) [BTA20-800CRG](#) [TO-220](#)  
[BTA16-800BRG](#) [BTW69-1200RG](#) [TYN825RG-JSM](#) [BTA12-600CRG](#) [BT136-600E](#) [BTA12-600BRG](#) [BT139-600E](#) [BTA24-800CRG](#) [TO-](#)  
[220](#) [BTA16-800BWRG](#) [BTA26-600BWRG](#) [BTA41-600BRG](#) [BT137-600E](#) [TYN612RG-JSM](#) [TYN625RG-JSM](#) [BT137-600D](#)