

| REV. | ECN Number | Description | Drawn |
|------|------------|----------------------------------|-----------------|
| 1 | CS19010036 | RELEASE | XPG_2019.01.09 |
| ② | E19040026 | Modify Spec. | Peak_2019.04.26 |
| ③ | E20030005 | Remove the housing reinforcement | Peak_2020.03.06 |

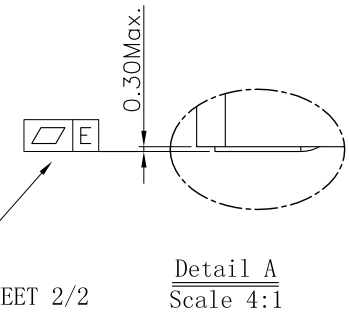

| TOLERANCE UNLESS OTHERWISE SPECIFIED | | | | SCALE | ORIGINAL DRAWN: | DATE | DWG. NO. | TITLE | REV. |
|--------------------------------------|-------|--------|-----|-------|-----------------|------------|--------------------------|-------------------------------|-------|
| X. X | ±0.30 | X. ° | ±3° | 1:1 | Peak | 2020.03.06 | 600-0000-0434 | BA41-XXAT CUSTOMER DRAWING | 3 |
| X. XX | ±0.20 | X. X° | ±2° | UNIT | Xu Peiguang | 2020.03.06 | PARTS NO. (INTENDED USE) | | SHEET |
| X. XXX | | X. XX° | ±1° | mm | APPROVE: | 2020.03.06 | BA41-XXAT-XX-XHX | | 1/2 |
| | | | | SIZE | Ady Zhou | | | | |

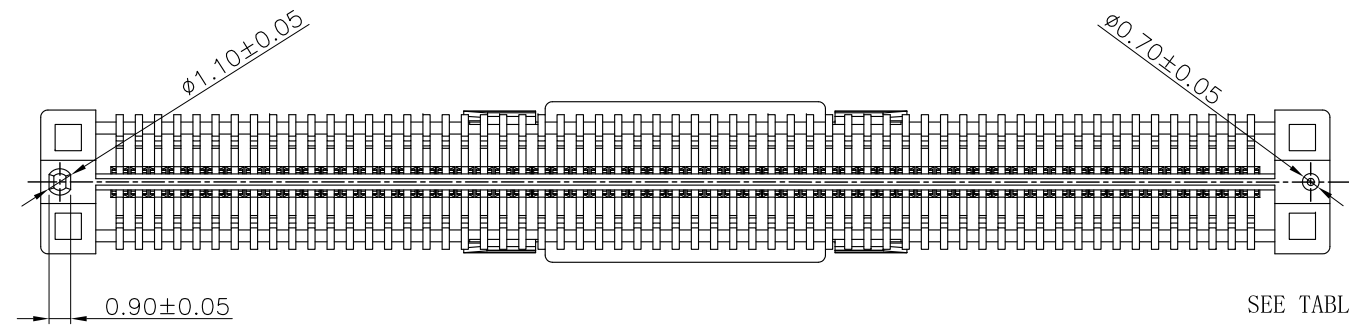
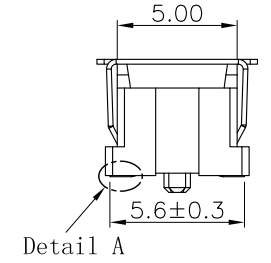
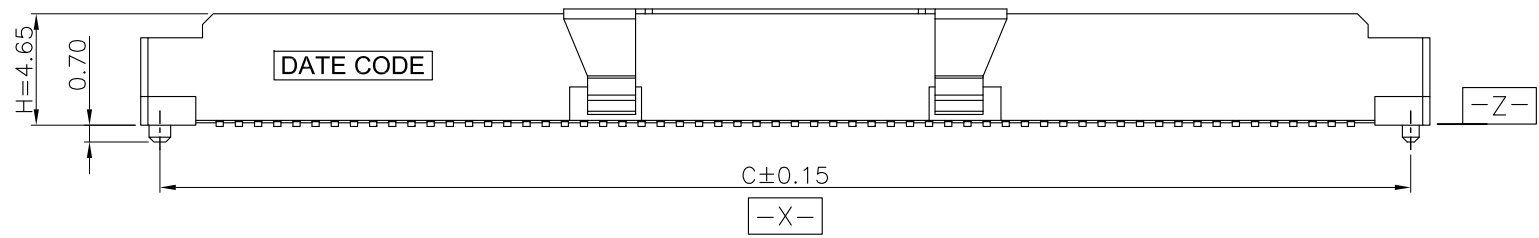
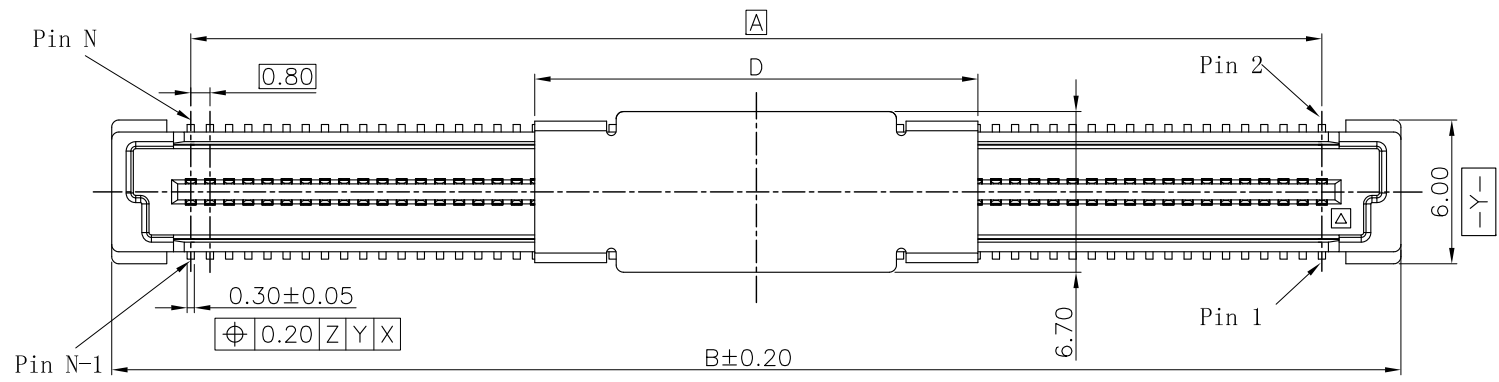
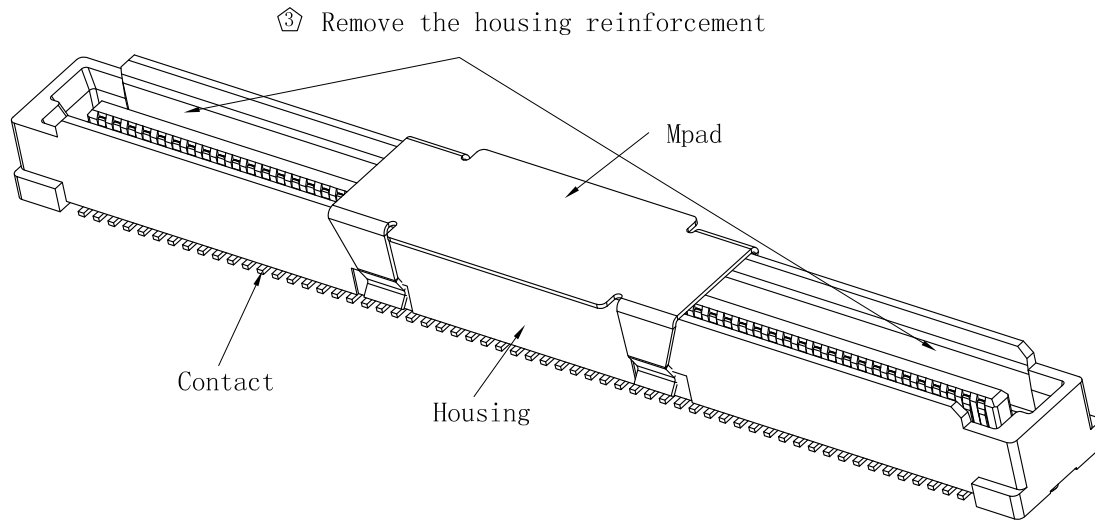

- NOTES: (UNLESS OTHERWISE SPECIFIED)
- DIMENSION SHALL BE INTERPRETED PER ANSI Y14.5M-1994.
 - MATERIAL:
 - HOUSING MATERIAL: HIGH TEMPERATURE PLASTICS.
 - CONTACT MATERIAL: COPPER ALLOY,
 - MPAD MATERIAL: STAINLESS STEEL.
 - ELECTRICAL SPECIFICATION:
 - CONTACT RESISTANCE: 40 m ohms Max(Initial).
 - INSULATION RESISTANCE: 1000M ohms Min.
 - CURRENT RATING: 0.8A.
 - DIELECTRIC WITHSTANDING VOLTAGE: 500V AC rms./minute
 - MECHANICAL SPECIFICATION:
 - DURABILITY:30 CYCLES Min.
 - INSERTION FORCE: 90gf Max. Per Pin.
 - WITHDRAWAL FORCE: 10gf Min. Per Pin.
 - PRODUCT NUMBER MATRIX:

Product Number Matrix: BA4 1-XX A T-X X -X H X

BTB Series: 0.80Pitch
 Plug
 PIN No.: N
 20°80:20°80PIN
 A0:100PIN | G0:160PIN
 C0:120PIN | I0:180PIN
 E0:140PIN | K0:200PIN

Height
 Soldering Type: T:SMT
 0:Without Chamfer
 1:With Chamfer
 Housing Color: Null:Nature, B:Black

Packing: B:REEL+MPAD
 H:Halogen free
 Plating

| Definition | Code |
|----------------------------|-----------------|
| ⊙ Matte Tin plated | A |
| ⊙ Bright Tin plated | V |
| ⊙ Duplex plated | |
| flash | K 1u" S 3u" L |
| 5u" | M 10u" N 15u" P |
| 20u" | Q 25u" T 30u" U |
| ⊙ All plated is lead free. | |

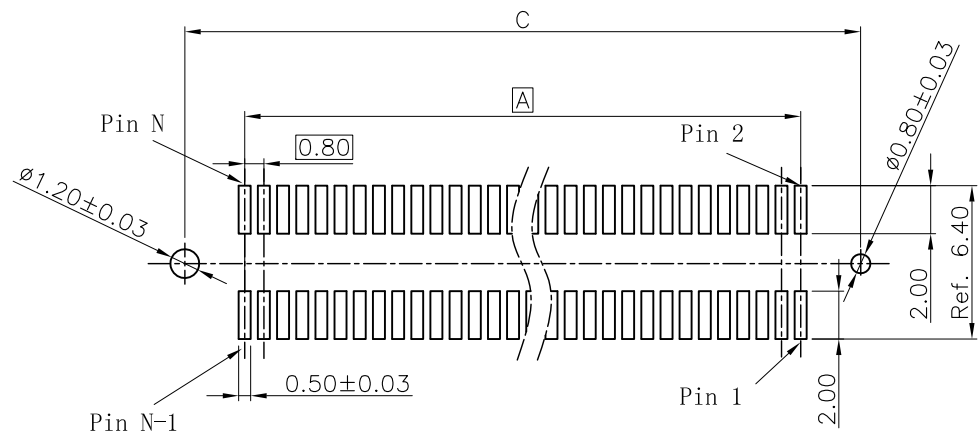

RECOMMENDED PCB LAYOUT
 TOLERANCE ±0.05

| CKT | DIM.A | DIM.B | DIM.C | DIM.D | DIM.E |
|-------|-------|-------|-------|-------|-------|
| 20 | 7.20 | 13.80 | 12.20 | 7.50 | 0.10 |
| 40 | 15.20 | 21.80 | 20.20 | | |
| 60 | 23.20 | 29.80 | 28.20 | | |
| 80 | 31.20 | 37.80 | 36.20 | 18.50 | 0.12 |
| 100 | 39.20 | 45.80 | 44.20 | | |
| * 120 | 47.20 | 53.80 | 52.20 | | |
| 140 | 55.20 | 61.80 | 60.20 | | |
| 160 | 63.20 | 69.80 | 68.20 | | |
| 180 | 71.20 | 77.80 | 76.20 | | |
| 200 | 79.20 | 85.80 | 84.20 | | |



| TOLERANCE UNLESS OTHERWISE SPECIFIED | | | |
|--------------------------------------|-------|-------|-----|
| X.X | ±0.30 | X.° | ±3° |
| X.XX | ±0.20 | X.X° | ±2° |
| X.XXX | | X.XX° | ±1° |

| | |
|-------|-----|
| SCALE | 1:1 |
| UNIT | mm |
| SIZE | A4 |

ORIGINAL DRAWN: Peak
 DATE: 2020.03.06
 CHECK: Xu Peiguang
 DATE: 2020.03.06
 APPROVE: Ady Zhou
 DATE: 2020.03.06

DWG. NO. 600-0000-0434
 PARTS NO. (INTENDED USE) BA41-XXAT-XX-XHX

TITLE: BA41-XXAT CUSTOMER DRAWING

REV. 3
 SHEET 2/2

X-ON Electronics

Largest Supplier of Electrical and Electronic Components

Click to view similar products for [Board to Board & Mezzanine Connectors](#) category:

Click to view products by [STWXE](#) manufacturer:

Other Similar products are found below :

[589158040000018](#) [MDF7C-18P-2.54DSA\(55\)](#) [FCN-268F036-G/BD](#) [FCN-268M012-G/0D](#) [FCN-268M024-G/1D](#) [MIS-048-01-F-D-DP-K](#)
[832-10-034-10-001000](#) [FX4C-80S-1.27DSA](#) [93696-330](#) [224393](#) [FCN-235D050-G/C](#) [210-93-314-41-105000](#) [MDF7-40DP-2.54DSA\(55\)](#)
[MIT-114-03-F-D-K](#) [55323-1519](#) [026-6203-PDB](#) [027-6203-PDB](#) [069159702701000](#) [101A10019X](#) [105061100000861+](#) [55650-0588-C](#) [75140-](#)
[7012](#) [87471-650](#) [YTW-30-07-H-Q-410-140](#) [YTT-112-01-H-Q](#) [063209](#) [10124054-515LF](#) [68685-603](#) [8-1616154-3](#) [MIS-019-01-F-D](#) [YTQ-](#)
[12103HQ](#) [541371078](#) [IL-WX-10PB-HF-B-E1000E](#) [FCN-214J100-G/0](#) [FCN-230C068-E/S](#) [354184](#) [MIT-019-04-F-D-K](#) [P50-028-DDS-TG](#)
[53309-2471](#) [54546-2071](#) [1586617-1](#) [504208-3010](#) [504208-5010](#) [504248-1010](#) [504248-1210](#) [504248-2010](#) [LST-115-07-S-D](#) [LST-105-07-G-](#)
[D](#) [9159005551906](#) [NDS100-004-BF](#)