

REV.	ECN Number	Description	Drawn
②	E18030025	CHANGE PART NUMBER	XPG_2018.03.29
③	E18050027	DEFINE PIN NO.	XPG_2018.05.23
④	E19010037	ADD PLATING CODE:Z	XPG_2019.01.22
⑤	E19110009	ADD PLATING CODE:3	WSY_2019.11.01

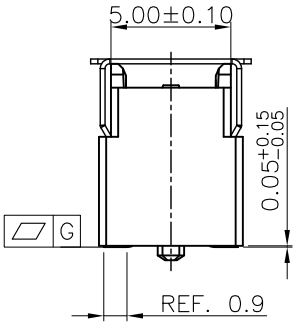
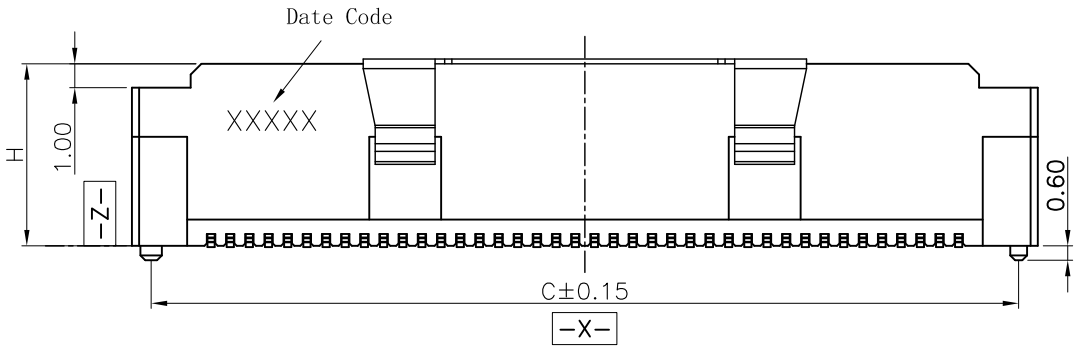
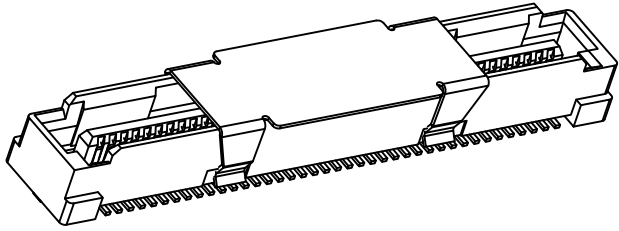
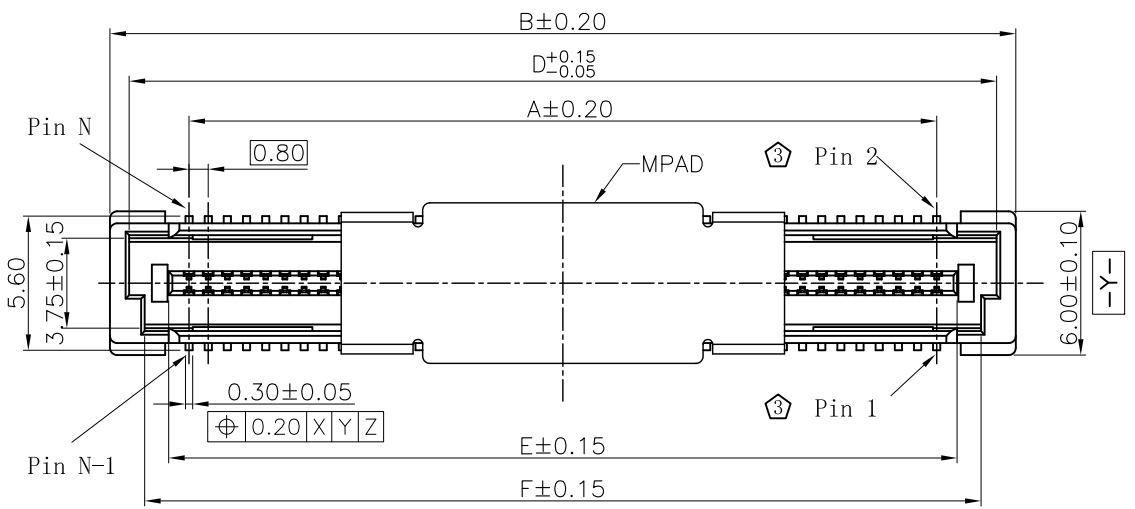

NOTES: (UNLESS OTHERWISE SPECIFIED)
 1. DIMENSION SHALL BE INTERPRETED PER ANSI Y14.5M-1994.
 2. MATERIAL:
 HOUSING MATERIAL: HIGH TEMPERATURE PLASTICS.
 CONTACT MATERIAL: COPPER ALLOY,
 VACUUM COVER MATERIAL: STAINLESS STEEL.
 3. PRODUCT NUMBER MATRIX:

BTB Series
 0.80Pitch
 Plug
 PIN No.: N
 40~80:40~80PIN
 A0:100PIN ; G0:160PIN
 C0:120PIN ; I0:180PIN
 E0:140PIN ; K0:200PIN

Height
 A: H=4.60mm
 B: H=5.60mm
 C: H=7.60mm
 D: H=6.60mm

Soldering Type
 T:SMT
 0:Without Chamfer
 1:With Chamfer

Packing:
 B: REEL+MPAD
 K: REEL
 Q: HOT SEALING REEL+MPAD

H: Halogen free

Plating

Definition	Code
Contact area:8u"	Z
Solder area:GF	
◎ Duplex plated	
flash	K 1u" S 3u" L
5u"	M 10u" N 15u" P
20u"	Q 25u" T 30u" U
2u"	3
◎ All plated is lead free.	

Housing Color
 Null:Nature
 B:Black

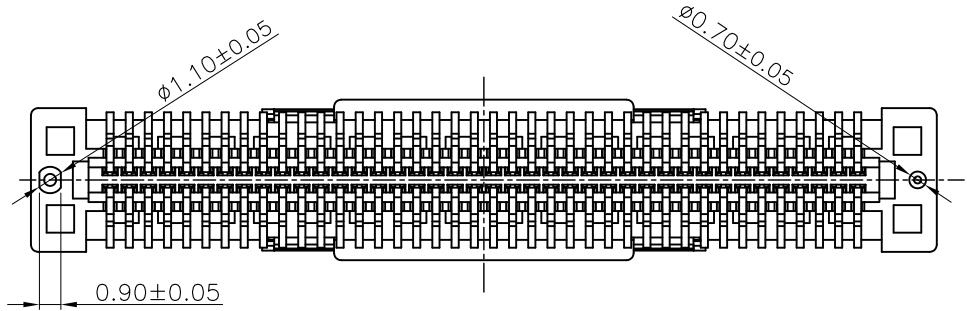

TOLERANCE UNLESS OTHERWISE SPECIFIED			
X.X	±0.30	X.°	±3°
X.XX	±0.20	X.X°	±2°
X.XXX		X.XX°	±1°

SCALE	1:1
UNIT	mm
SIZE	A4

ORIGINAL DRAWN:
Wu shuying
 CHECK:
Xu Peiguang
 APPROVE:
Ady Zhou

DATE
2019.11.01
 DATE
2019.11.01
 DATE
2019.11.01

DWG. NO.
600-0000-0232
 PARTS NO. (INTENDED USE)
BA41-XXXT-XX-XHX

TITLE
BA41
CUSTOMER DRAWING

REV.
5
 SHEET
1/2

PRODUCT NUMBER MATRIX: BA41-XX X T-X X -X H X

↑
0:Without Chamfer
1:With Chamfer

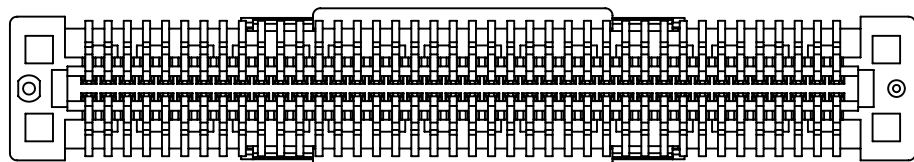

BA41-XXXT-0X-XHX

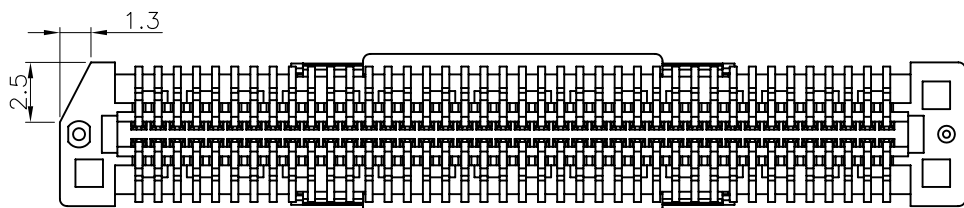

BA41-XXXT-1X-XHX

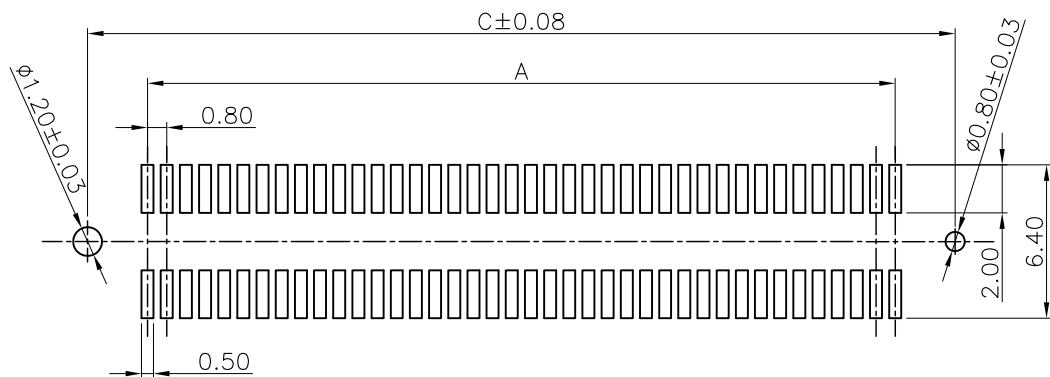

RECOMMENDED PCB LAYOUT

TOLERANCE ± 0.05

OLD AND PART NO. COMPARISON	
OLD	NEW
AB41-80NB-1-001	BA41-80CT-1-NHB
ZIW-80S6-N-1-B	BA41-80CT-0-NHB
AB41-80NB-0-001	
AB41-80NB-H-001	
ZIW-40S8-VN-1-B	BA41-40BT-0-NHB
ZIW-40S8-N-1-B	
AB41-40NB-H-003	
ZIW-60S8-VN-1-B	BA41-60BT-0-NHB
AB41-60NB-0-003	
AB41-60NB-H-003	
ZIW-A0S8-VN-1-B	BA41-A0BT-0-NHB
AB41-A0NB-0-003	
AB41-A0NB-H-003	
ZIW-80S8-N-1-B-S01	BA41-80BT-1-NHB
AB41-80NB-H-004	BA41-80AT-1-NHB
AB41-80NB-1-004	

CKT	DIM.A	DIM.B	DIM.C	DIM.D	DIM.E	DIM.F	DIM.G
40	15.20	21.80	20.20	20.20	16.90	18.90	0.10
50	19.20	25.80	24.20	24.20	20.90	22.90	
60	23.20	29.80	28.20	28.20	24.90	26.90	
80	31.20	37.80	36.20	36.20	32.90	34.90	0.12
100	39.20	45.80	44.20	44.20	40.90	42.90	
120	47.20	53.80	52.20	52.20	48.90	50.90	
140	55.20	61.80	60.20	60.20	56.90	58.90	
160	63.20	69.80	68.20	68.20	64.90	66.90	
180	71.20	77.80	76.20	76.20	72.90	74.90	
200	79.20	85.80	84.20	84.20	80.90	82.90	



ShenZhen ShenTai weixiang Electronics Co., Ltd.

TOLERANCE UNLESS OTHERWISE SPECIFIED

X.X	±0.30	X.°	±3°
X.XX	±0.20	X.X°	±2°
X.XXX		X.XX°	±1°

SCALE	1:1
UNIT	mm
SIZE	A4

ORIGINAL DRAWN:
Wu shuying
CHECK:
Xu Peiguang
APPROVE:
Ady Zhou

DATE
2019. 11. 01
DATE
2019. 11. 01
DATE
2019. 11. 01

DWG. NO.
600-0000-0232
PARTS NO. (INTENDED USE)
BA41-XXXT-XX-XHX

TITLE
BA41
CUSTOMER DRAWING

REV.
5
SHEET
2/2

X-ON Electronics

Largest Supplier of Electrical and Electronic Components

Click to view similar products for [Board to Board & Mezzanine Connectors](#) category:

Click to view products by [STWXE](#) manufacturer:

Other Similar products are found below :

[589158040000018](#) [MDF7C-18P-2.54DSA\(55\)](#) [FCN-268F036-G/BD](#) [FCN-268M012-G/0D](#) [FCN-268M024-G/1D](#) [MIS-048-01-F-D-DP-K](#)
[832-10-034-10-001000](#) [FX4C-80S-1.27DSA](#) [93696-330](#) [224393](#) [FCN-235D050-G/C](#) [210-93-314-41-105000](#) [MDF7-40DP-2.54DSA\(55\)](#)
[MIT-114-03-F-D-K](#) [55323-1519](#) [026-6203-PDB](#) [027-6203-PDB](#) [069159702701000](#) [101A10019X](#) [105061100000861+](#) [55650-0588-C](#) [75140-](#)
[7012](#) [87471-650](#) [YTW-30-07-H-Q-410-140](#) [YTT-112-01-H-Q](#) [063209](#) [10124054-515LF](#) [68685-603](#) [8-1616154-3](#) [MIS-019-01-F-D](#) [YTQ-](#)
[12103HQ](#) [541371078](#) [IL-WX-10PB-HF-B-E1000E](#) [FCN-214J100-G/0](#) [FCN-230C068-E/S](#) [354184](#) [MIT-019-04-F-D-K](#) [P50-028-DDS-TG](#)
[53309-2471](#) [54546-2071](#) [1586617-1](#) [504208-3010](#) [504208-5010](#) [504248-1010](#) [504248-1210](#) [504248-2010](#) [LST-115-07-S-D](#) [LST-105-07-G-](#)
[D](#) [9159005551906](#) [NDS100-004-BF](#)