

REV.	ECN Number	Description	Drawn
1	E17070069	RELEASE	XPG_2017.07.20
②	E18030021	ADD PART NUMBER	XPG_2018.03.26

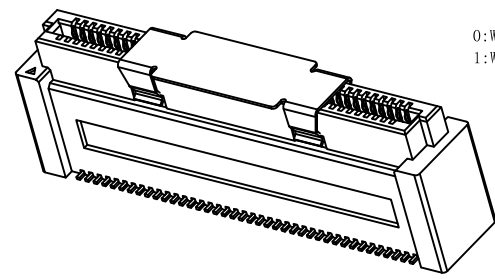
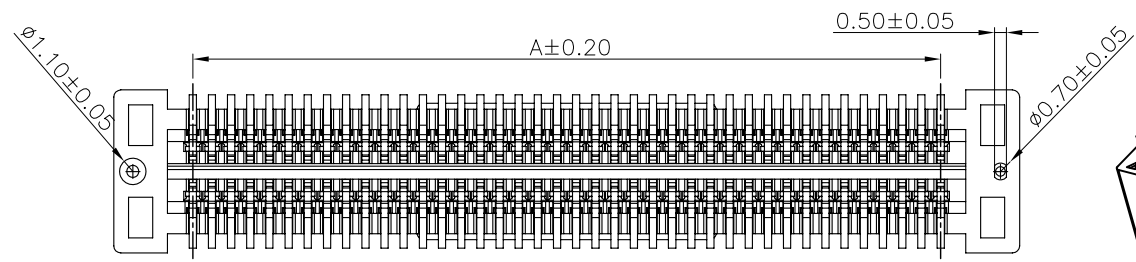
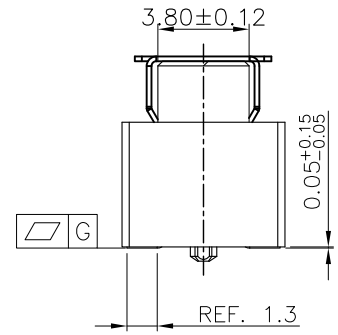
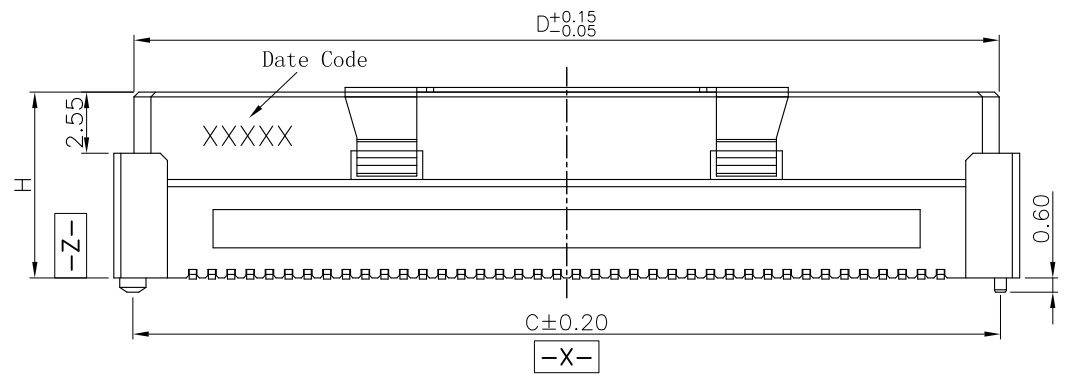
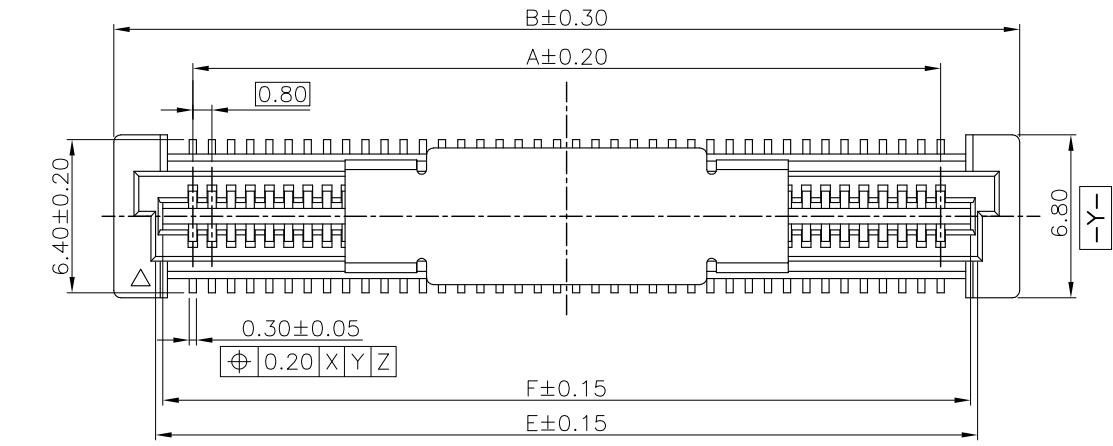

- NOTES: (UNLESS OTHERWISE SPECIFIED)
- DIMENSION SHALL BE INTERPRETED PER ANSI Y14.5M-1994.
 - MATERIAL:
HOUSING MATERIAL: HIGH TEMPERATURE PLASTICS.
CONTACT MATERIAL: COPPER ALLOY,
VACUUM COVER MATERIAL: STAINLESS STEEL.
 - ELECTRICAL SPECIFICATION:
CONTACT RESISTANCE: 50 m ohms Max(Initial).
INSULATION RESISTANCE: 100M ohms Min.
CURRENT RATING: 0.5A.
DIELECTRIC WITHSTANDING VOLTAGE: 500V AC rms./minute
 - MECHANICAL SPECIFICATION:
DURABILITY:30 CYCLES.
INSERTION FORCE: 150gf Max. PER PIN.
WITHDRAWAL FORCE: 25gf Min. PER PIN.
 - PRODUCT NUMBER MATRIX:

Series code	Receptacle	PIN No.	Height	Soldering Type	Housing Color
BTB	0.80 Pitch	40°80:40°80PIN	B: H=7.75mm C: H=11.75mm	T:SMT	Null:Nature B:Black
0		A0:100PIN ; G0:160PIN C0:120PIN ; I0:180PIN E0:140PIN ; K0:200PIN		0:Without Chamfer 1:With Chamfer	

Definition	Code
⊙Matte Tin plated	A
⊙Bright Tin plated	V
⊙Gold plated over all	
Flash B 1u" R 3u" C	
5u" D 10u" E 15u" F	
20u" G 25u" H 30u" J	
⊙Duplex plated	
flash K 1u" S 3u" L	
5u" M 10u" N 15u" P	
20u" Q 25u" T 30u" U	
⊙All plated is lead free.	



ShenZhen ShenTai weixiang Electronics Co., Ltd.

TOLERANCE UNLESS OTHERWISE SPECIFIED			
X.X	±0.30	X.°	±3°
X.XX	±0.20	X.X°	±2°
X.XXX		X.XX°	±1°

SCALE	1:1
UNIT	mm
SIZE	A4

ORIGINAL DRAWN:	Xu Peiguang	DATE	2018.03.26
CHECK:	Xie Yong	DATE	2018.03.26
APPROVE:	Ady Zhou	DATE	2018.03.26

DWG. NO.	600-0000-0223
PARTS NO. (INTENDED USE)	BA42-XXXT-XX-XHX

TITLE	BA42 CUSTOMER DRAWING
-------	--------------------------

REV.	2
SHEET	1/3

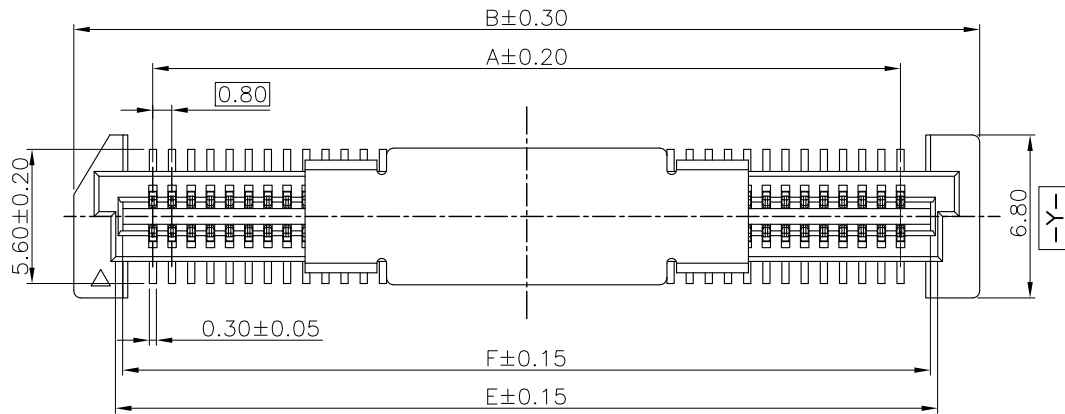

- NOTES: (UNLESS OTHERWISE SPECIFIED)
- DIMENSION SHALL BE INTERPRETED PER ANSI Y14.5M-1994.
 - MATERIAL:
 - HOUSING MATERIAL: HIGH TEMPERATURE PLASTICS.
 - CONTACT MATERIAL: COPPER ALLOY,
 - VACUUM COVER MATERIAL: STAINLESS STEEL.
 - ELECTRICAL SPECIFICATION:
 - CONTACT RESISTANCE: 50 m ohms Max(Initial).
 - INSULATION RESISTANCE: 100M ohms Min.
 - CURRENT RATING: 0.5A.
 - DIELECTRIC WITHSTANDING VOLTAGE: 500V AC rms./minute
 - MECHANICAL SPECIFICATION:
 - DURABILITY:30 CYCLES.
 - INSERTION FORCE: 150gf Max. PER PIN.
 - WITHDRAWAL FORCE: 25gf Min. PER PIN.
 - PRODUCT NUMBER MATRIX:

Not enough space to print date code

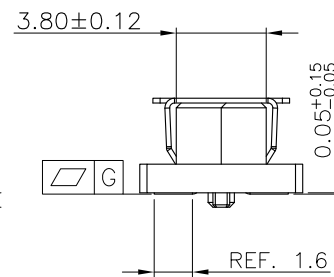
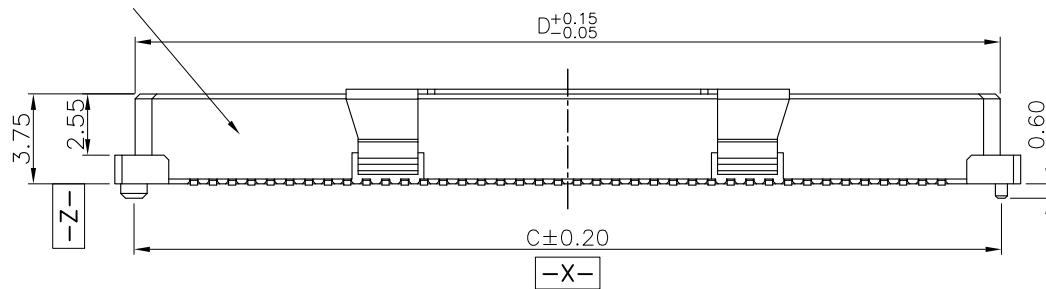

Series code: B A 4 2-XX X T-X X -X H X

Receptacle: 0.80 Pitch

PIN No. 40~80:40~80PIN
A0:100PIN G0:160PIN
C0:120PIN I0:180PIN
E0:140PIN K0:200PIN

Height: A: H=3.75mm

Soldering Type: T:SMT
0:Without Chamfer
1:With Chamfer

Housing Color: Null:Nature B:Black

Packing:
B: REEL+MPAD
Q: HOT SEALING
REEL+MPAD
H: Halogen free
Plating

Definition	Code
⊙ Matte Tin plated	A
⊙ Bright Tin plated	V
⊙ Gold plated over all	
flash B 1u" R 3u" C	
5u" D 10u" E 15u" F	
20u" G 25u" H 30u" J	
⊙ Duplex plated	
flash K 1u" S 3u" L	
5u" M 10u" N 15u" P	
20u" Q 25u" T 30u" U	
⊙ All plated is lead free.	

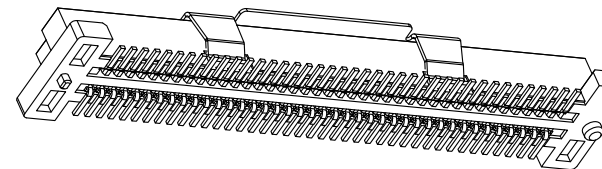
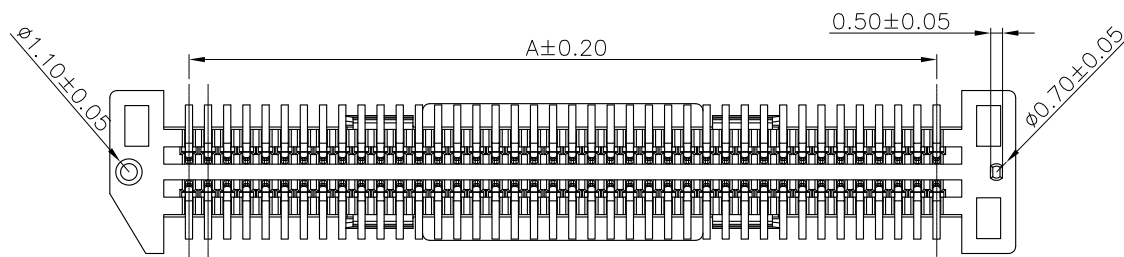

ShenZhen ShenTai weixiang Electronics Co., Ltd.

TOLERANCE UNLESS OTHERWISE SPECIFIED

X. X	±0.30	X. °	±3°
X. XX	±0.20	X. X°	±2°
X. XXX		X. XX°	±1°

SCALE	1:1
UNIT	mm
SIZE	A4

ORIGINAL DRAWN: Xu Peiguang
DATE: 2018.03.26
CHECK: Xie Yong
DATE: 2018.03.26
APPROVE: Ady Zhou
DATE: 2018.03.26

DATE: 2018.03.26

DWG. NO. 600-0000-0223
PARTS NO. (INTENDED USE) BA42-XXXT-XX-XXH

TITLE BA42 CUSTOMER DRAWING

REV. 2
SHEET 2/3

PRODUCT NUMBER MATRIX: BA42-XXXT-XX-XHX

0:Without Chamfer
1:With Chamfer

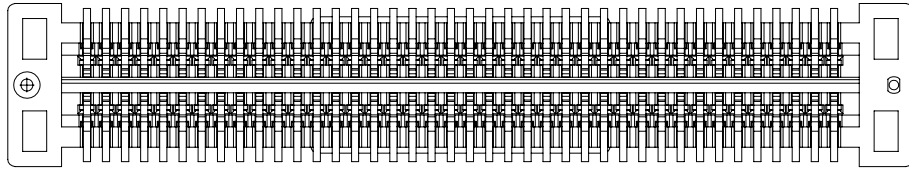

BA42-XXXT-0X-XHX

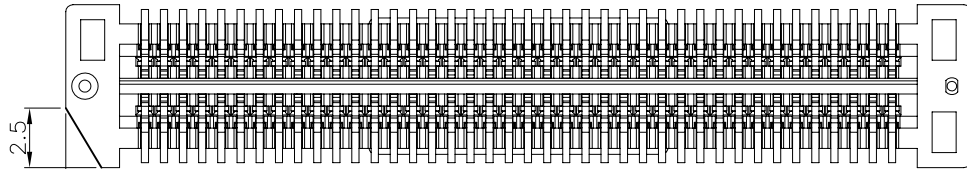

BA42-XXXT-1X-XHX

RECOMMENDED PCB LAYOUT

TOLERANCE ± 0.05

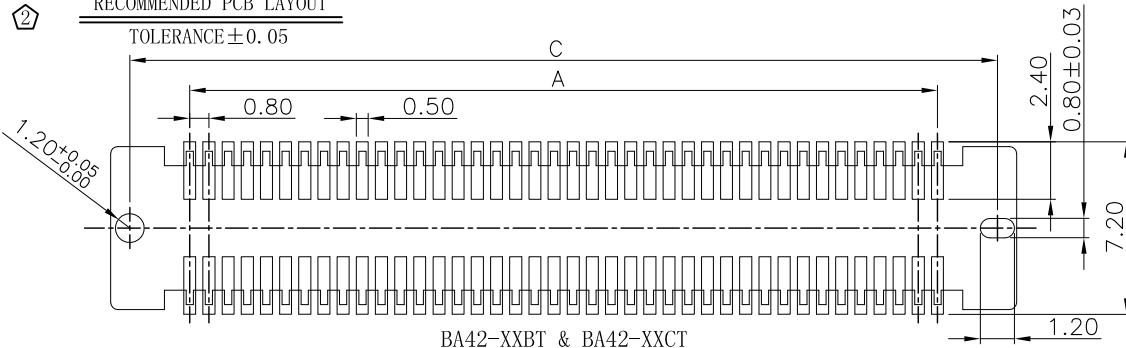

BA42-XXBT & BA42-XXCT

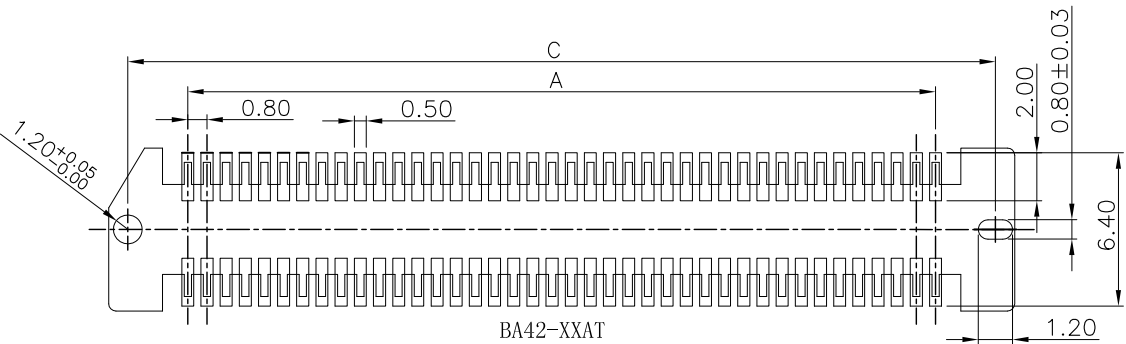

BA42-XXAT



OLD AND PART NO. COMPARISON	
OLD	NEW
ZIV-40S4-VN-1-B	BA42-40CT-0-NHB
ZIV-80S4-N-1-B	BA42-80CT-0-NHB
ZIV80S4N1B	
AB42-80NB-H-003	
AB42-80NB-1-003	BA42-80CT-1-NHB
ZIV-40S5-N-1-B-S01	BA42-40BT-1-NHB
ZIV-80S5-N-1-B-S01	BA42-80BT-1-NHB
AB42-80NB-H-001	BA42-80AT-1-NHB
AB42-A0NB-H-002	BA42-A0BT-0-NHB

PIN NO.	CIRCUITS	DIM.A	DIM.B	DIM.C	DIM.D	DIM.E	DIM.F	DIM.G
20	20PIN	7.20	13.80	12.80	12.10	10.7	9.70	0.10
40	40PIN	15.20	21.80	20.20	20.10	18.7	17.7	
60	60PIN	23.20	29.80	28.20	28.10	26.7	25.7	
80	80PIN	31.20	37.80	36.20	36.10	34.7	33.7	
A0	100PIN	39.20	45.80	44.20	44.10	42.7	41.7	0.12
C0	120PIN	47.20	53.80	52.20	52.10	50.7	49.7	
E0	140PIN	55.20	61.80	60.20	60.10	58.7	57.7	
G0	160PIN	63.20	69.80	68.20	68.10	66.7	65.7	
I0	180PIN	71.20	77.80	76.20	76.10	74.7	73.7	
K0	200PIN	79.20	85.80	84.20	84.10	82.7	81.7	



ShenZhen ShenTai weixiang Electronics Co., Ltd.

TOLERANCE UNLESS OTHERWISE SPECIFIED

X.X	± 0.30	X.°	$\pm 3^\circ$
X.XX	± 0.20	X.X°	$\pm 2^\circ$
X.XXX		X.XX°	$\pm 1^\circ$

SCALE 1:1
UNIT mm
SIZE A4

ORIGINAL DRAWN: Xu Peiguang
CHECK: Xie Yong
APPROVE: Ady Zhou

DATE 2018.03.26
DATE 2018.03.26
DATE 2018.03.26

DWG. NO. 600-0000-0223
PARTS NO. (INTENDED USE) BA42-XXXT-XX-XHX

TITLE BA42 CUSTOMER DRAWING

REV. 2
SHEET 3/3

X-ON Electronics

Largest Supplier of Electrical and Electronic Components

Click to view similar products for [Headers & Wire Housings](#) category:

Click to view products by [STWXE](#) manufacturer:

Other Similar products are found below :

[95000-104TRLF](#) [10135584-644402LF](#) [DF62W-EP2022PCA](#) [95000-106TRLF](#) [DF62W-2022SCA](#) [DF62W-EP2022PC](#) [2203348](#) [DF62W-2022SC](#) [1084018](#) [1029039](#) [1084017](#) [802-10-012-10-002000](#) [1112640](#) [1112639](#) [891-007-9SS-BST1T](#) [000-34000](#) [0008550134](#) [0009482033](#) [0009507031](#) [57102-F02-18ULF](#) [57102-S06-03LF](#) [57202-S52-04LF](#) [PCN6-15S-2.5E](#) [0039019024](#) [58102-G61-06LF](#) [582553-1](#) [0009485154](#) [0009508121](#) [0022285053](#) [0050291907](#) [018731A](#) [LY20-4P-DT1-P1E-BR](#) [02.125.8002.8](#) [60101931](#) [60598-1 \(Cut Strip\)](#) [M1625-3R/100](#) [61062-3](#) [61082-181009](#) [CSU011177004](#) [636-1427](#) [638009-1](#) [641938-9](#) [641991-4](#) [644168-1](#) [644827-2](#) [647662-1](#) [65039-019ELF](#) [65692-001LF](#) [65781-018](#) [65781-047](#)