

- 备注:
1. 塑胶材料: LCP-GA130, 黑色, 防火等级: UL 94v-0
 2. 端子材料: 铜合金
 3. 额定电压: 50V AC/DC for 1 minute
 4. 接触阻抗: 50mΩ max. initial (不包括导体阻抗)
 5. 耐电压: 500V AC for 1 minute
 6. 绝缘阻抗: 100MΩ min.
 7. 额定电流: 0.5A
 8. 寿命: 30次 min
 9. 插入力: 150gf max. /pin, 拔出力: 8.5gf min. /pin
 10. 保持力: 250gf 最小/pin
 11. 有害物质需符合Rohs2.0标准.
 12. 尺寸符合ANSI Y14.5M-1994.

料号说明:
BB41-XXFT-1B-XHR
F: 塑胶高度11.35mm
公母合高12.70mm-13.70mm
Pin数

X方向浮动量: ±0.5
Y方向浮动量: ±0.5
Z方向浮动量: ±0.5



TOLERANCE UNLESS OTHERWISE SPECIFIED			
X.X	±0.35	X.*	±5°
X.XX	±0.20	X.X*	±3°
X.XXX		X.XX*	±2°

SCALE	1:1	ORIGINAL DRAWN:	Qin Su	DATE	2021/10/13
UNIT	mm	CHECK:	Guangyu Guo	DATE	2021/10/13
SIZE	A4	APPROVE:	Ady Zhou	DATE	2021/10/13

DWG. NO.	600-0000-0519	TITLE	0.80mm Pitch 浮动BTB 客户图
PARTS NO. (INTENDED USE)	BB41-XXFT-1B-XHR	REV.	1
		SHEET	1/2

40PIN: BB41-40FT-1B-XHR

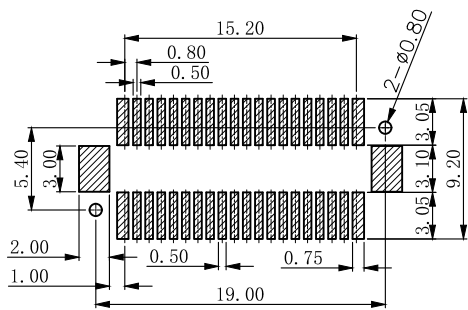
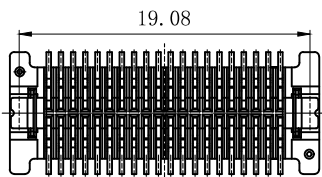
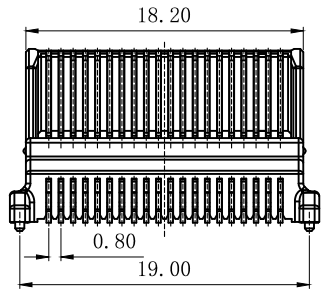
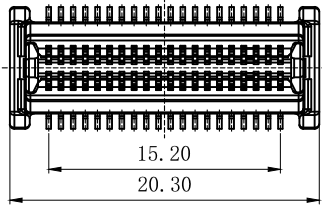

RECOMMENDED PCB LAYOUT
TOLERANCE: ±0.05mm

60PIN: BB41-60FT-1B-XHR

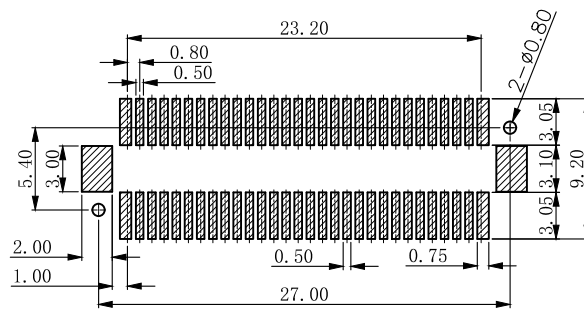
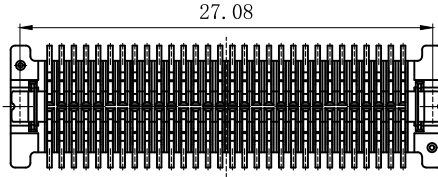
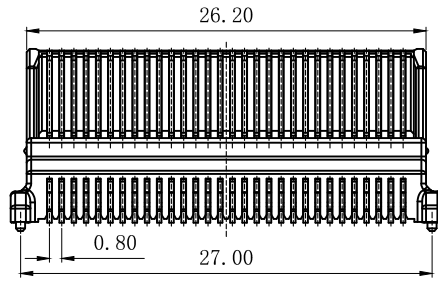
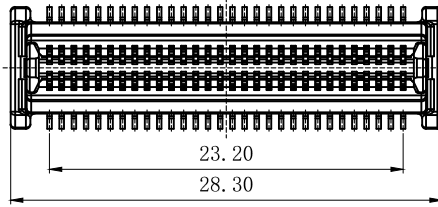

RECOMMENDED PCB LAYOUT
TOLERANCE: ±0.05mm

80PIN: BB41-80FT-1B-XHR

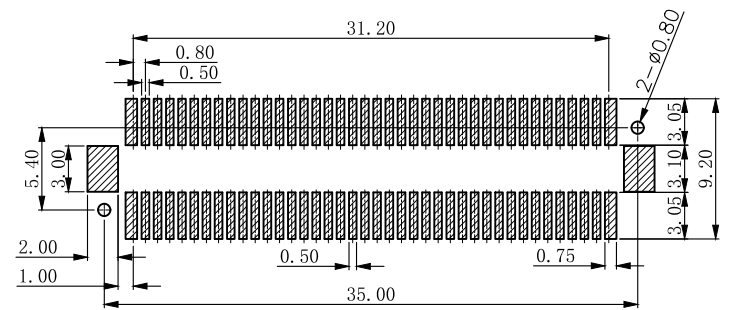
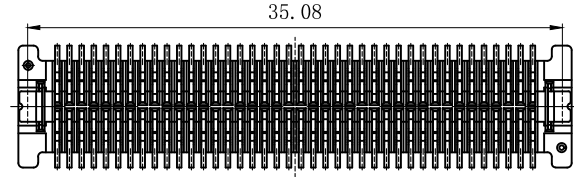
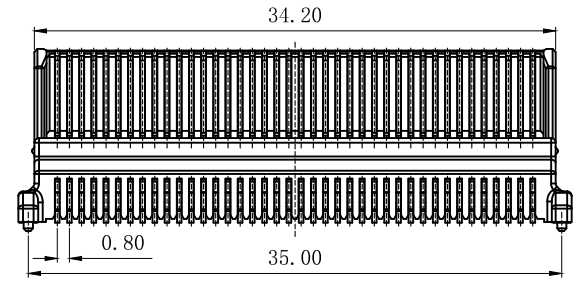
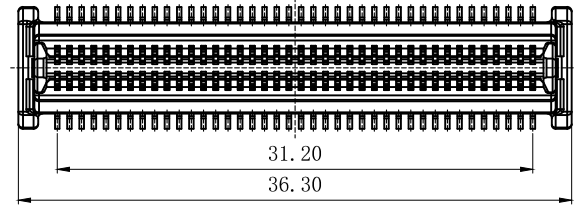

RECOMMENDED PCB LAYOUT
TOLERANCE: ±0.05mm



ShenZhen ShenTai weiXiang Electronics Co.,

TOLERANCE UNLESS OTHERWISE SPECIFIED

X.X	±0.35	X.*	±5°
X.XX	±0.20	X.X*	±3°
X.XXX		X.XX*	±2°

SCALE	1:1
UNIT	mm
SIZE	A4

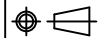

ORIGINAL DRAWN:	Qin Su	DATE	2021/10/13
CHECK:	Guangyu Guo	DATE	2021/10/13
APPROVE:	Ady Zhou	DATE	2021/10/13

DWG. NO.	600-0000-0519
PARTS NO. (INTENDED USE)	BB41-XXFT-1B-XHR

TITLE	0.80mm Pitch 浮动BTB 客户图
-------	---------------------------

REV.	1
SHEET	2/2

X-ON Electronics

Largest Supplier of Electrical and Electronic Components

Click to view similar products for [Board to Board & Mezzanine Connectors](#) category:

Click to view products by [STWXE](#) manufacturer:

Other Similar products are found below :

[589158040000018](#) [MDF7C-18P-2.54DSA\(55\)](#) [FCN-268F036-G/BD](#) [FCN-268M012-G/0D](#) [FCN-268M024-G/1D](#) [MIS-048-01-F-D-DP-K](#)
[832-10-034-10-001000](#) [FX4C-80S-1.27DSA](#) [93696-330](#) [224393](#) [FCN-235D050-G/C](#) [210-93-314-41-105000](#) [MDF7-40DP-2.54DSA\(55\)](#)
[55323-1519](#) [069159702701000](#) [101A10019X](#) [105061100000861+](#) [75140-7012](#) [87471-650](#) [1744382-4](#) [063209](#) [10124054-515LF](#) [68685-603](#)
[8-1616154-3](#) [541371078](#) [IL-WX-10PB-HF-B-E1000E](#) [FX23-40P-0.5SV15B](#) [FCN-214J100-G/0](#) [354184](#) [P50-028-DDS-TG](#) [53309-2471](#)
[54546-2071](#) [1586617-1](#) [504248-1210](#) [504248-2010](#) [1-1437355-2](#) [9159005551906](#) [NDS100-004-BF](#) [93696-730LF](#) [91922-31141LF](#) [505274-](#)
[3440](#) [501493-2410](#) [504208-3410](#) [505006-0811](#) [505274-2040](#) [202436-1600](#) [202477-0414](#) [71660-7580](#) [73420-5192](#) [360-10-107-00-001000](#)