

REV.	ECN Number	Description	Drawn
1	CS20120080	初版发行	2020/12/09

100PIN:BB41-A0GT-1B-XHR

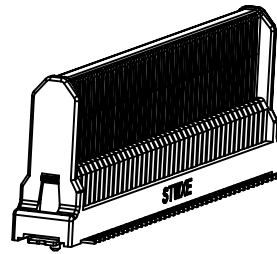

3D VIWE  
(With out cover)

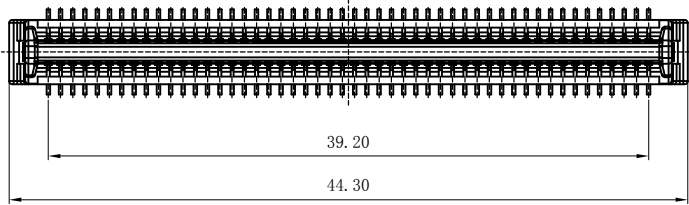
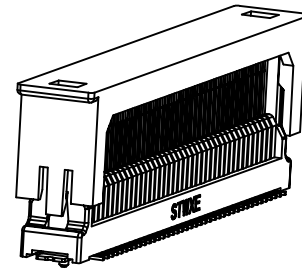

3D VIWE  
(With cover)

备注:

1. 塑胶材料: LCP-GA130, 黑色, 防火等级: UL 94v-0
2. 端子材料: 铜合金
3. 额定电压: 50V AC/DC for 1 minute
4. 接触阻抗: 50mΩ max. initial (不包括导体阻抗)
5. 耐电压: 500V AC for 1 minute
6. 绝缘阻抗: 100MΩ min.
7. 额定电流: 0.5A
8. 寿命: 30次 min
9. 插入力: 150gf max./pin, 拔出力: 8.5gf min./pin
10. 保持力: 250gf最小/pin
11. 有害物质需符合Rohs2.0标准.
12. 尺寸符合ANSI Y14.5M-1994.

料号说明:

BB41-XXGT-1B-XHR

G: 公母合高12.25mm-13.25mm

Pin数

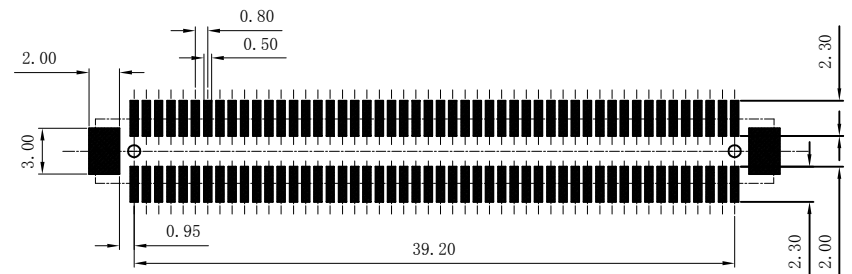
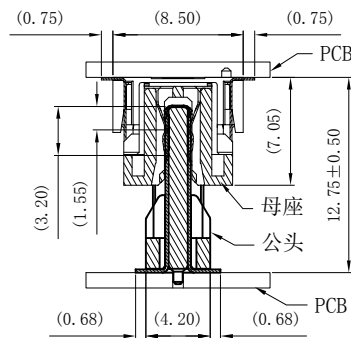
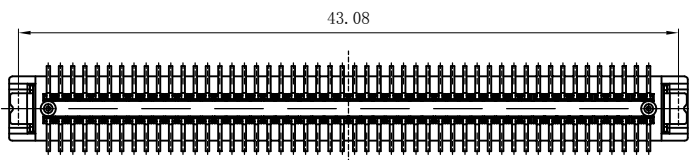
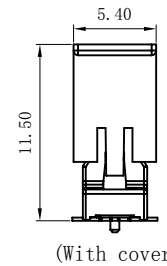
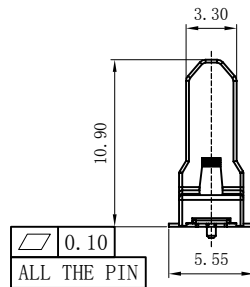
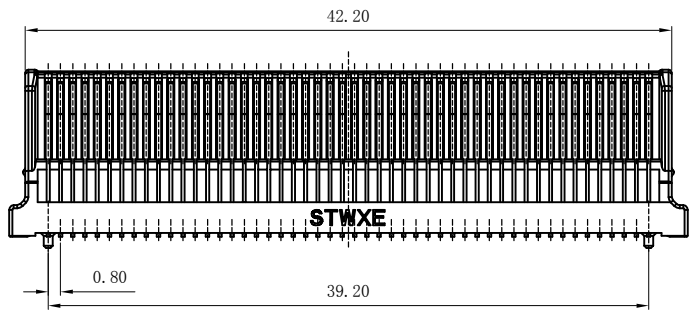

RECOMMENDED PCB LAYOUT

TOLERANCE: ±0.05mm

(公母合高)

X方向浮动量: ±0.5

Y方向浮动量: ±0.5

Z方向浮动量: ±0.5



ShenZhen ShenTai weixiang Electronics Co.,

TOLERANCE UNLESS OTHERWISE SPECIFIED			
X.X	±0.35	X.'	±5°
X.XX	±0.20	X.X'	±3°
X.XXX		X.XX'	±2°

SCALE	1:1	ORIGINAL DRAWN:	Qinghua Fu	DATE	2020/12/09
UNIT	mm	CHECK:	Guangyu Guo	DATE	2020/12/09
SIZE	A4	APPROVE:	Ady Zhou	DATE	2020/12/09

DWG. NO.	600-0000-0450	TITLE	0.80mm Pitch 浮动BTB (配高12.75mm) 客户图
PARTS NO. (INTENDED USE)	BB41-XXGT-1B-XHR	REV.	1

SHEET	1/2
-------	-----

40PIN: BB41-40GT-1B-XHR

60PIN: BB41-60GT-1B-XHR

80PIN: BB41-80GT-1B-XHR

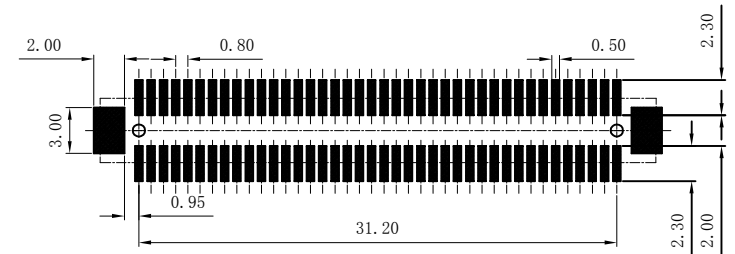
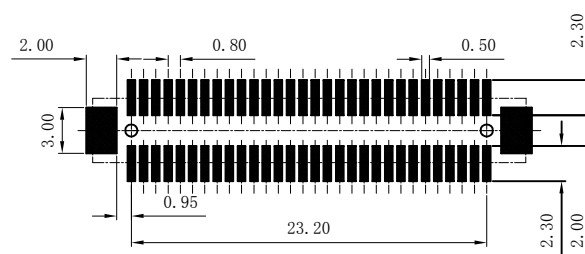
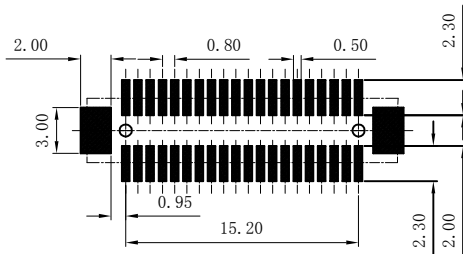
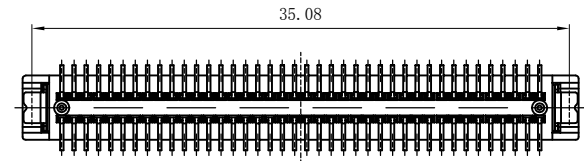
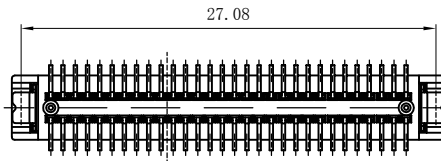
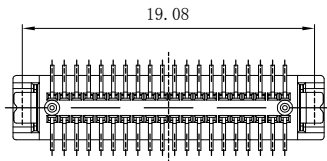
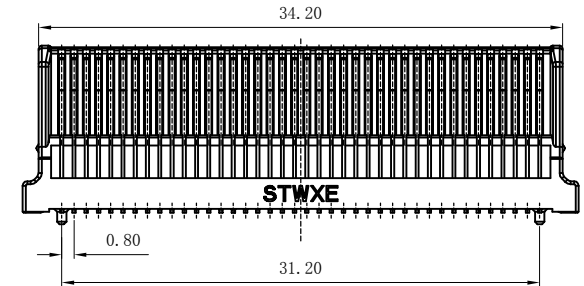
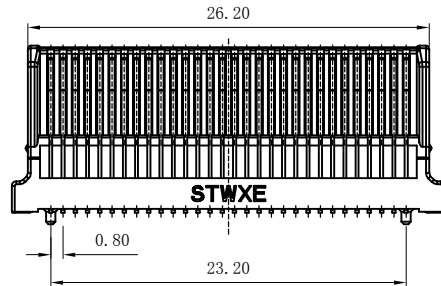
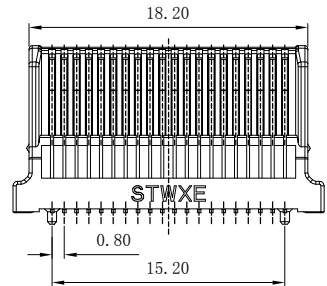
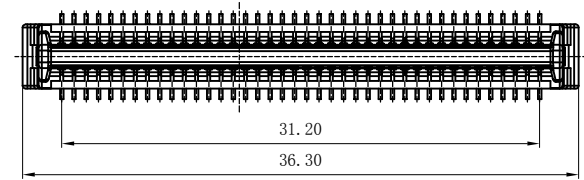
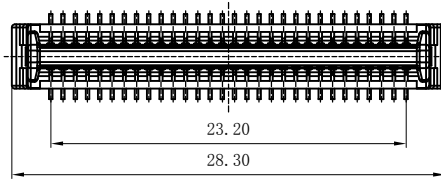
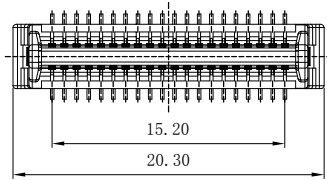

RECOMMENDED PCB LAYOUT  
TOLERANCE: ±0.05mm

RECOMMENDED PCB LAYOUT  
TOLERANCE: ±0.05mm

RECOMMENDED PCB LAYOUT  
TOLERANCE: ±0.05mm



ShenZhen ShenTai weixiang Electronics Co.,

TOLERANCE UNLESS OTHERWISE SPECIFIED

X.X	±0.35	X.'	±5°
X.XX	±0.20	X.X'	±3°
X.XXX		X.XX'	±2°

SCALE	1:1
UNIT	mm
SIZE	A4

ORIGINAL DRAWN:	Smark	DATE	2020/12/09
CHECK:	Guangyu Guo	DATE	2020/12/09
APPROVE:	Ady Zhou	DATE	2020/12/09

DWG. NO.	600-0000-0450
PARTS NO. (INTENDED USE)	BB41-XXGT-1B-XHR

TITLE	0.80mm Pitch 浮动BTB 客户图
REV.	1
SHEET	2/2

## X-ON Electronics

Largest Supplier of Electrical and Electronic Components

*Click to view similar products for [Board to Board & Mezzanine Connectors](#) category:*

*Click to view products by [STWXE](#) manufacturer:*

Other Similar products are found below :

[589158040000018](#) [MDF7C-18P-2.54DSA\(55\)](#) [FCN-268F036-G/BD](#) [FCN-268M012-G/0D](#) [FCN-268M024-G/1D](#) [FCN-723J004/1](#) [MIS-048-01-F-D-DP-K](#) [832-10-034-10-001000](#) [FX4C-80S-1.27DSA](#) [93696-330](#) [224393](#) [FCN-235D050-G/C](#) [210-93-314-41-105000](#) [2-22603-0](#) [MDF7-40DP-2.54DSA\(55\)](#) [5031084030](#) [MIT-114-03-F-D-K](#) [55323-1519](#) [45970-4130](#) [YFT-20-05-H-03-SB-K](#) [503308-3040](#) [026-6203-PDB](#) [027-6203-PDB](#) [069159702701000](#) [101A10019X](#) [105061100000861+](#) [55650-0588-C](#) [75140-7012](#) [87471-650](#) [YTW-30-07-H-Q-410-140](#) [YTT-112-01-H-Q](#) [063209](#) [0717420006](#) [FCN-268F024-G0D](#) [10124054-515LF](#) [68685-603](#) [8-1616154-3](#) [MIS-019-01-F-D](#) [IL-WX-10PB-HF-B-E1000E](#) [YFT-50-05-H-10-SB-K](#) [FCN-268M024-G/3D](#) [MDF7-16DP-2.54DSA\(55\)](#) [AXE810124](#) [FCN-214J100-G/0](#) [FCN-230C068-E/S](#) [AXE812124](#) [74220-001](#) [354184](#) [P50-028-DDS-TG](#) [53309-2471](#)