

REV.	ECN Number	Description	Drawn
1	CS21060039	初版发行	2021/06/10

100PIN:BB41-A0JT-1B-XHR

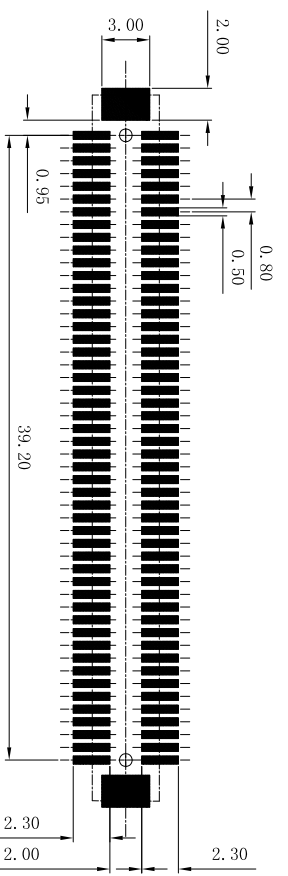
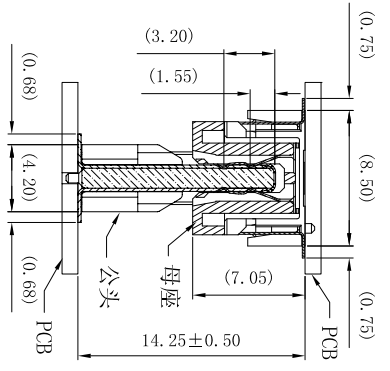
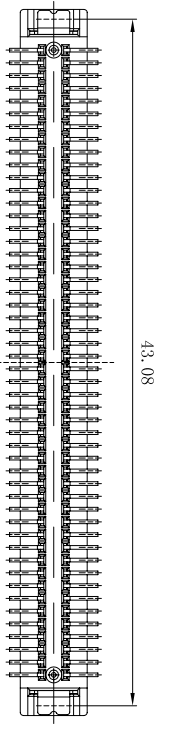
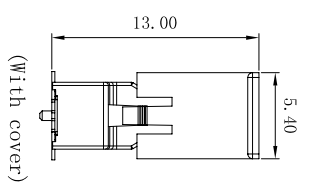
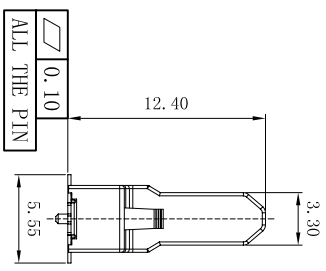
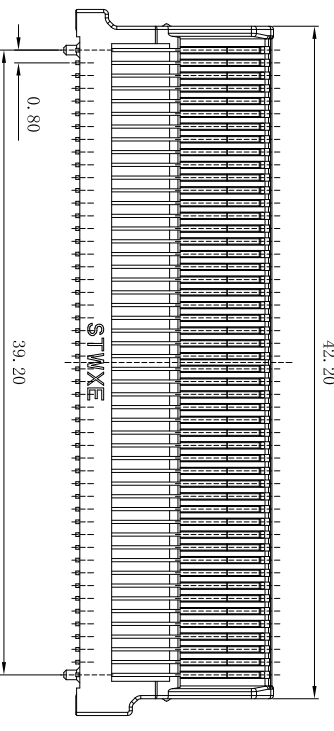
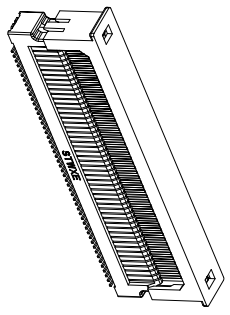
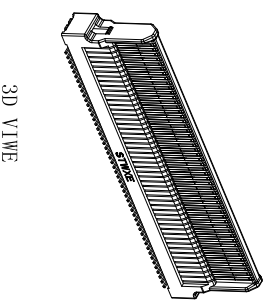
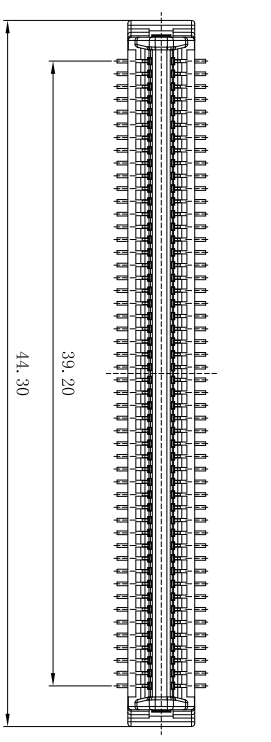

(公母合高)

X方向浮动量: ±0.5  
Y方向浮动量: ±0.5  
Z方向浮动量: ±0.5

RECOMMENDED PCB LAYOUT  
TOLERANCE: ±0.05mm

- 备注:
1. 塑胶材料: LCP, 黑色, 防火等级: UL 94v-0
  2. 端子材料: 铜合金
  3. 额定电压: 50V AC/DC for 1 minute
  4. 接触电阻: 50mΩ max. initial (不包括导体阻抗)
  5. 耐电压: 500V AC for 1 minute
  6. 绝缘电阻: 100MΩ min.
  7. 额定电流: 0.5A
  8. 寿命: 30次 min
  9. 插入力: 150gf max./pin, 拔出力: 8.5gf min./pin
  10. 保持力: 250gf 最小/pin
  11. 有害物质需符合RoHS2.0标准。
  12. 尺寸符合ANSI Y14.5M-1994。
- 料号说明:  
BB41-XXJT-1B-XHR  
G: 公母合高13.75mm-14.75mm  
Pin数

		TOLERANCE UNLESS OTHERWISE SPECIFIED		SCALE 1:1		ORIGINAL DRAWN: Qinghua Fu		DATE 2021/06/10		DWG. NO. 600-0000-0575		TITLE 0.80mm Pitch 浮动BIB 客户图		REV. 1	
X.X	±0.35	X.	±5°	UNIT	mm	CHECK:	Guangyu Guo	DATE	2021/06/10	PARTS NO. (INTENDED USE)		SHEET		1/2	
X.XX	±0.20	X.X	±3°	SIZE	A4	APPROVE:	Adv Zhou	DATE	2021/06/10	BB41-XXJT-1B-XHR					
X.XXX		X.XX	±2°												

Shenzhen Shenhai Weixiang Electronics Co., Ltd.

40PIN: BB41-40JT-1B-XHR

60PIN: BB41-60JT-1B-XHR

80PIN: BB41-80JT-1B-XHR

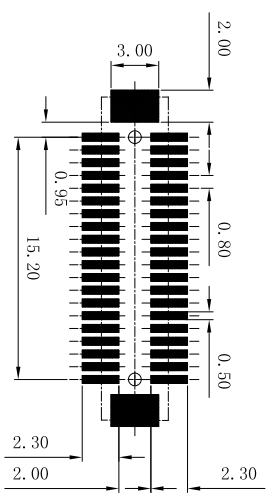
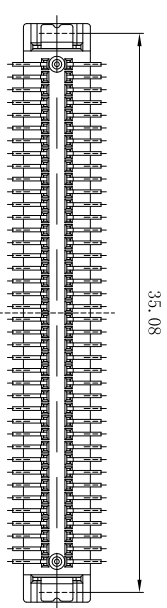
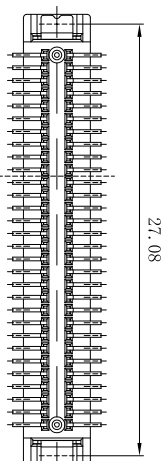
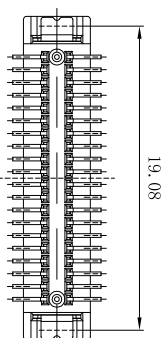
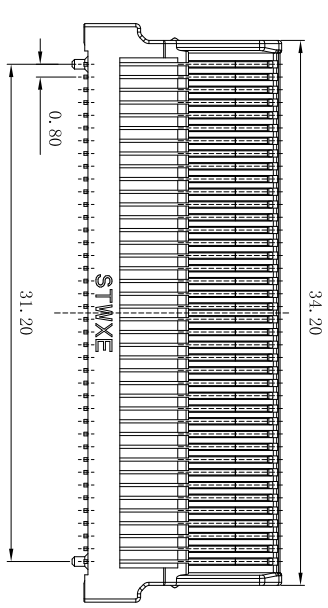
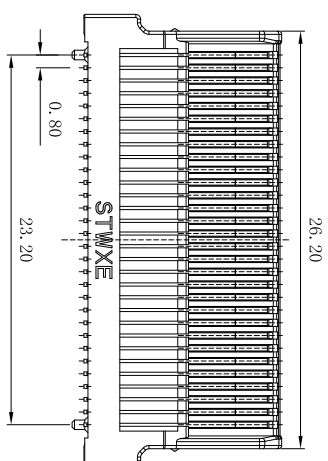
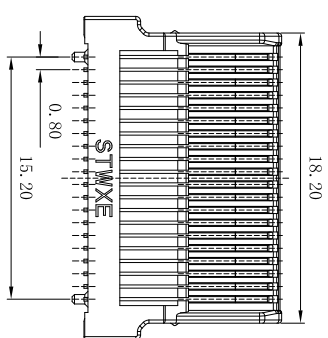
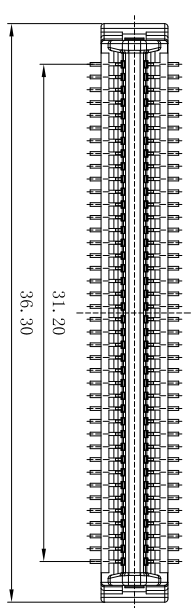
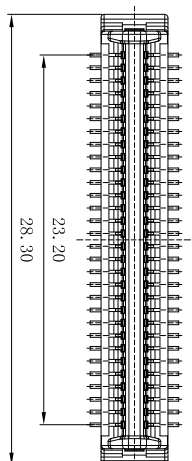
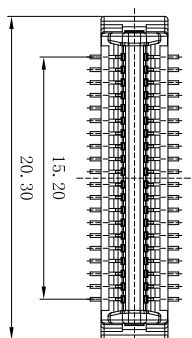

RECOMMENDED PCB LAYOUT  
TOLERANCE: ±0.05mm

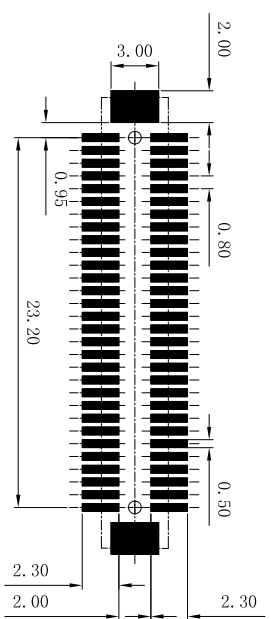

RECOMMENDED PCB LAYOUT  
TOLERANCE: ±0.05mm

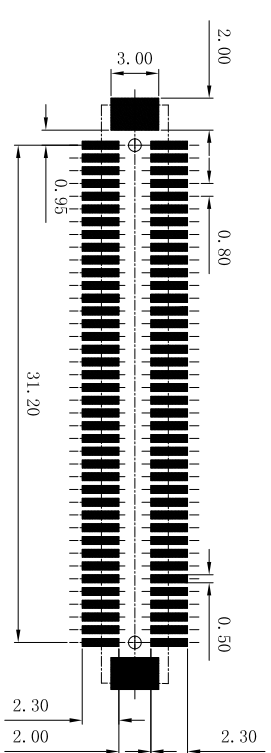

RECOMMENDED PCB LAYOUT  
TOLERANCE: ±0.05mm



Shenzhen Shentai Weixiang Electronics Co., Ltd.

TOLERANCE UNLESS OTHERWISE SPECIFIED

X.X	±0.35	X.	±5°
X.XX	±0.20	X.X	±3°
X.XXX		X.XX	±2°

SCALE 1:1

UNIT	mm
SIZE	A4

ORIGINAL DRAWN: Qinghua Fu

CHECK:	Guangyu Guo	DATE	2021/06/10
APPROVE:	Ady Zhou	DATE	2021/06/10

DWG. NO. 600-0000-0575

PARTS NO. (INTENDED USE)	BB41-XXJT-1B-XHR
--------------------------	------------------

TITLE 0.80mm Pitch 浮动BIB 客户图

SHEET	2/2
-------	-----

REV. 1

SHEET	2/2
-------	-----

## X-ON Electronics

Largest Supplier of Electrical and Electronic Components

*Click to view similar products for [Board to Board & Mezzanine Connectors](#) category:*

*Click to view products by [STWXE](#) manufacturer:*

Other Similar products are found below :

[589158040000018](#) [MDF7C-18P-2.54DSA\(55\)](#) [FCN-268F036-G/BD](#) [FCN-268M012-G/0D](#) [FCN-268M024-G/1D](#) [FCN-723J004/1](#) [MIS-048-01-F-D-DP-K](#) [832-10-034-10-001000](#) [FX4C-80S-1.27DSA](#) [93696-330](#) [224393](#) [FCN-235D050-G/C](#) [210-93-314-41-105000](#) [2-22603-0](#) [MDF7-40DP-2.54DSA\(55\)](#) [5031084030](#) [MIT-114-03-F-D-K](#) [55323-1519](#) [45970-4130](#) [YFT-20-05-H-03-SB-K](#) [503308-3040](#) [026-6203-PDB](#) [027-6203-PDB](#) [069159702701000](#) [101A10019X](#) [105061100000861+](#) [55650-0588-C](#) [75140-7012](#) [87471-650](#) [YTW-30-07-H-Q-410-140](#) [YTT-112-01-H-Q](#) [063209](#) [0717420006](#) [FCN-268F024-G0D](#) [10124054-515LF](#) [68685-603](#) [8-1616154-3](#) [MIS-019-01-F-D](#) [IL-WX-10PB-HF-B-E1000E](#) [YFT-50-05-H-10-SB-K](#) [FCN-268M024-G/3D](#) [MDF7-16DP-2.54DSA\(55\)](#) [AXE810124](#) [FCN-214J100-G/0](#) [FCN-230C068-E/S](#) [AXE812124](#) [74220-001](#) [354184](#) [P50-028-DDS-TG](#) [53309-2471](#)