

100PIN: BB42-AOAT-1B-XHR

REV.	ECN Number	Description	Drawn
1	CS18030011	First issue	LGJ_2018.03.05
2	E20010009	Add new specifications	Smark
3	E20100007	图面整合(每个料号单独列出)	FQH_2020.10.13

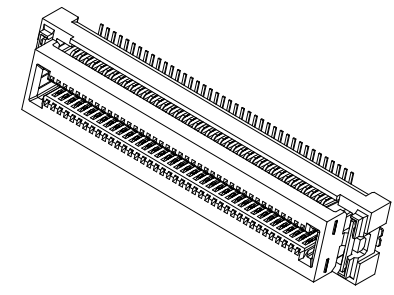

- NOTES:
- HOUSING MATERIAL:HIGH TEMPERATURE PLASTICS
BLACK, UL94V-0.
 - CONTACT MATERIAL:COPPER ALLOY.
 - RATING VOLTAGE: 50V AC/DC
 - CONTACT RESISTANCE: 80 m ohms MAX, INITIAL.
 - DIELECTRIC WITHSTANDING VOLTAGE: 500V AC rms./MINUTE.
 - INSULATION RESISTANCE: 100 M ohms MIN.
 - CURRENT RATING: 0.5 AMPERE.
 - DURABILITY: 30 CYCLES MIN.
 - INSERTION FORCE: 150g MAX. PER CONTACT.
 - WITHDRAW FORCE: 8.5g MIN. PER CONTACT.
 - OPERATING TEMPERATURE RANGE: -40° C~+105° C
 - STORAGE TEMPERATURE RANGE: -40° C~+105° C
 - ALL HARMFUL SUNSTANCES SHOULD BE COMPLIANT WITH THE ROHS2.0 REQUIREMENTS.
 - PRODUCT NUMBER MATRIX:

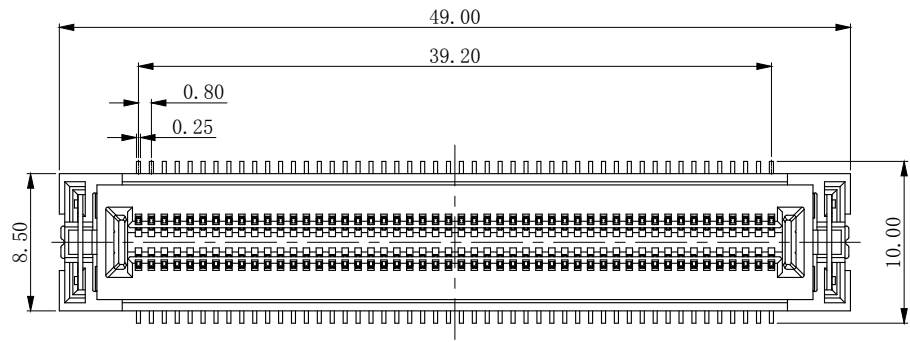
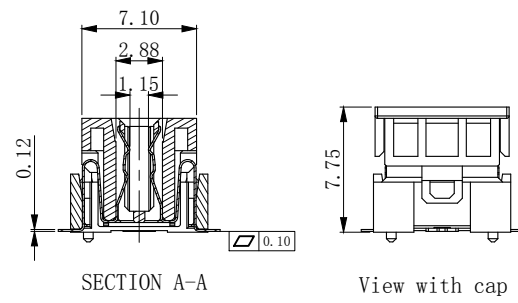
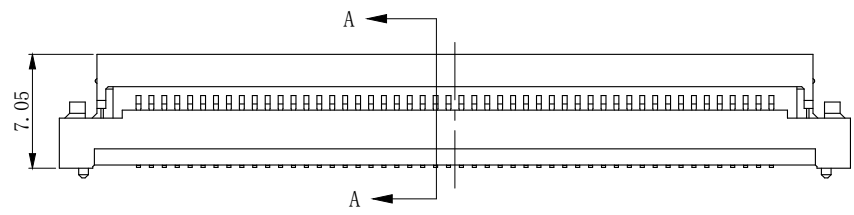

Pitch: 0.80mm
 Female
 PIN NO.
 Height flow code
 SMT TYPE

BB42-XXAT-1B-XHR

packaging: REEL+PAD
 Halogen-free high temperature material
 Electroplating code

◎Gold plated				
flash	B	1u"	R	3u"
5u"	D	10u"	E	15u"
20u"	G	25u"	H	30u"

Colour : black
 Extended code

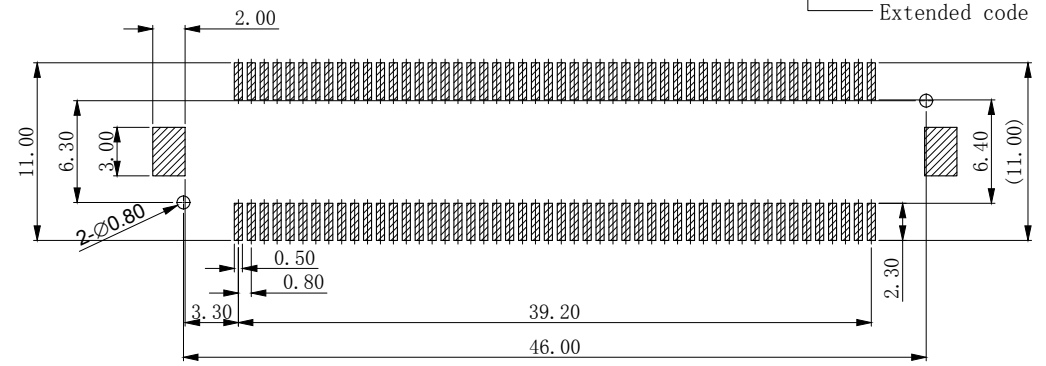
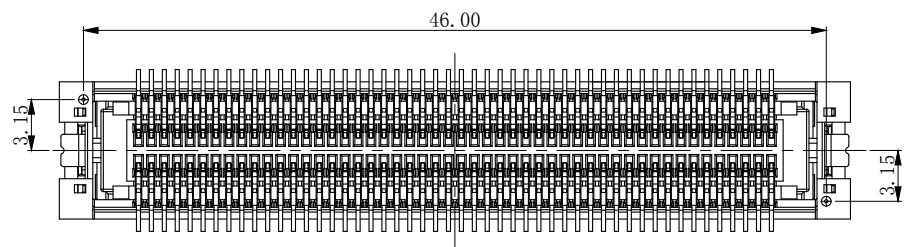

RECOMMENDED PCB LAYOUT
 TOLERANCE: ±0.05mm



TOLERANCE UNLESS OTHERWISE SPECIFIED				SCALE 1:1	ORIGINAL DRAWN: Qinghua Fu	DATE 2020.10.13	DWG. NO. 600-0000-0228	TITLE	REV. 3
X.X	±0.30	X.°	±3°	UNIT mm	CHECK: Guangyu Guo	DATE 2020.10.13	PARTS NO. (INTENDED USE) BB42-XXAT-1B-XHR	CUSTOMER DRAWING	SHEET
X.XX	±0.20	X.X°	±2°	SIZE A4	APPROVE: Ady Zhou	DATE 2020.10.13			1/2
X.XXX		X.XX°	±1°						

40PIN: BB42-40AT-1B-XHR

60PIN: BB42-60AT-1B-XHR

80PIN: BB42-80AT-1B-XHR

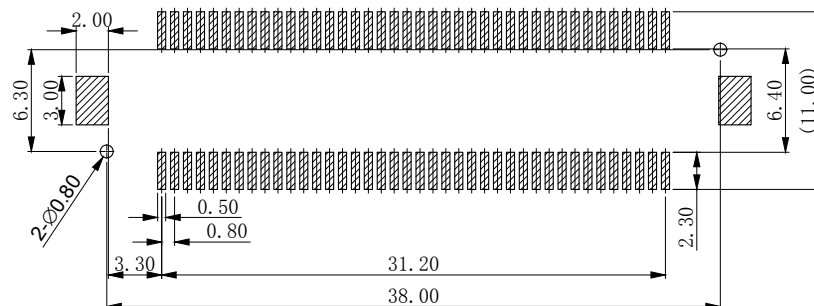
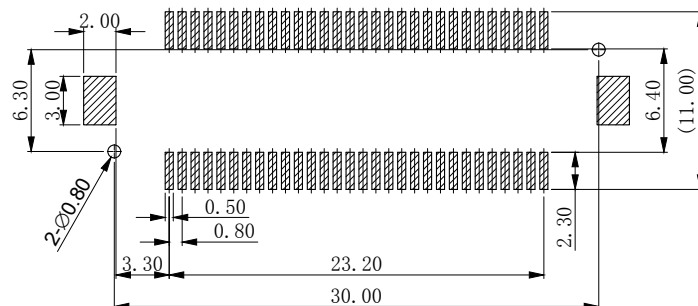
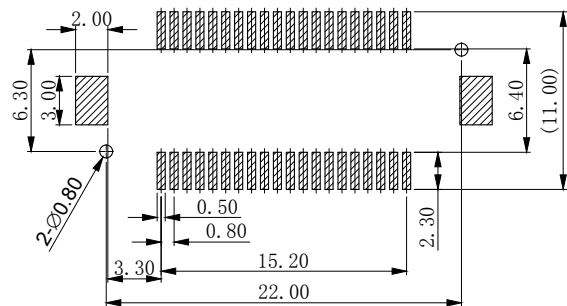
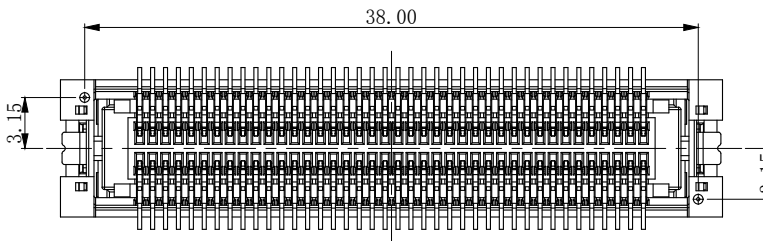
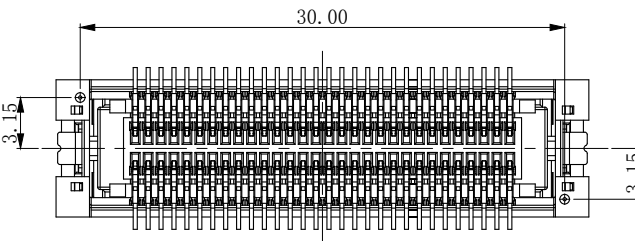
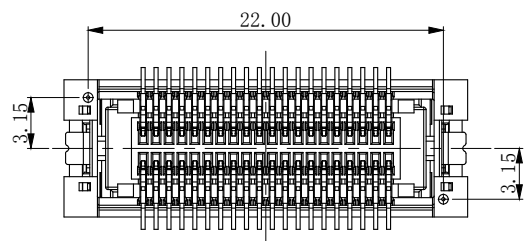
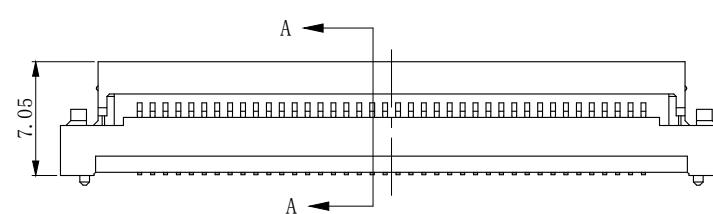
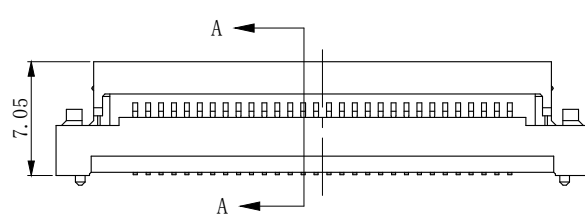
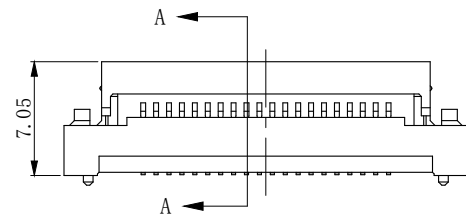
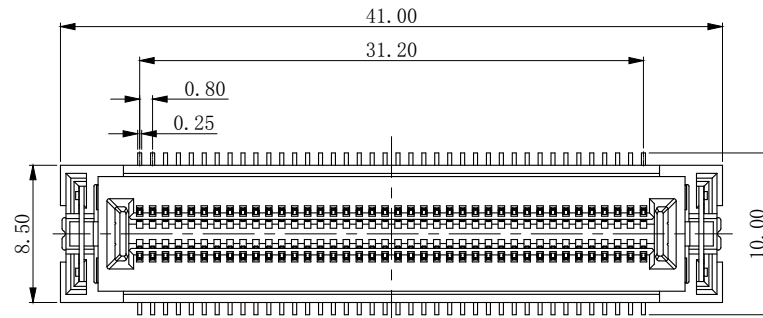
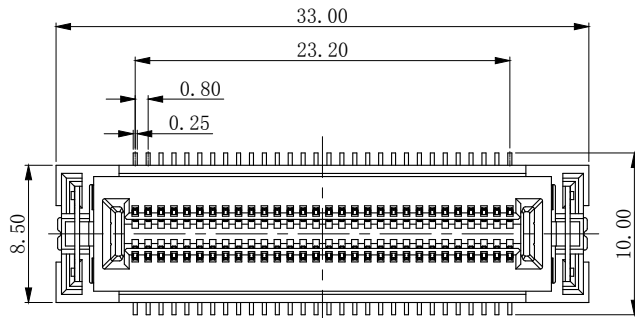
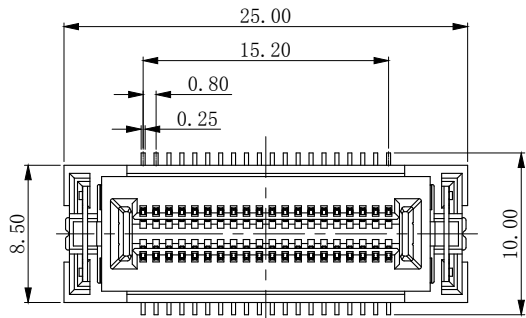

RECOMMENDED PCB LAYOUT

TOLERANCE: $\pm 0.05\text{mm}$

RECOMMENDED PCB LAYOUT

TOLERANCE: $\pm 0.05\text{mm}$

RECOMMENDED PCB LAYOUT

TOLERANCE: $\pm 0.05\text{mm}$



Shenzhen ShenTai weixiang Electronics Co., Ltd.

TOLERANCE UNLESS OTHERWISE SPECIFIED

X.X	± 0.30	X.°	$\pm 3^\circ$
X.XX	± 0.20	X.X°	$\pm 2^\circ$
X.XXX		X.XX°	$\pm 1^\circ$

SCALE 1:1

UNIT mm

SIZE A4



ORIGINAL DRAWN: Qinghua Fu

CHECK: Guangyu Guo

APPROVE: Ady Zhou

DATE 2020.10.13

DATE 2020.10.13

DATE 2020.10.13

DWG. NO.

600-0000-0228

PARTS NO. (INTENDED USE)

BB42-XXAT-1B-XHR

TITLE

CUSTOMER DRAWING

REV.

3

SHEET

2/2

X-ON Electronics

Largest Supplier of Electrical and Electronic Components

Click to view similar products for [Board to Board & Mezzanine Connectors](#) category:

Click to view products by [STWXE](#) manufacturer:

Other Similar products are found below :

[589158040000018](#) [MDF7C-18P-2.54DSA\(55\)](#) [FCN-268F036-G/BD](#) [FCN-268M012-G/0D](#) [FCN-268M024-G/1D](#) [FCN-723J004/1](#) [MIS-048-01-F-D-DP-K](#) [832-10-034-10-001000](#) [FX4C-80S-1.27DSA](#) [93696-330](#) [224393](#) [FCN-235D050-G/C](#) [210-93-314-41-105000](#) [2-22603-0](#) [MDF7-40DP-2.54DSA\(55\)](#) [5031084030](#) [MIT-114-03-F-D-K](#) [55323-1519](#) [45970-4130](#) [YFT-20-05-H-03-SB-K](#) [503308-3040](#) [026-6203-PDB](#) [027-6203-PDB](#) [069159702701000](#) [101A10019X](#) [105061100000861+](#) [55650-0588-C](#) [75140-7012](#) [87471-650](#) [YTW-30-07-H-Q-410-140](#) [YTT-112-01-H-Q](#) [063209](#) [0717420006](#) [FCN-268F024-G0D](#) [10124054-515LF](#) [68685-603](#) [8-1616154-3](#) [MIS-019-01-F-D](#) [IL-WX-10PB-HF-B-E1000E](#) [YFT-50-05-H-10-SB-K](#) [FCN-268M024-G/3D](#) [MDF7-16DP-2.54DSA\(55\)](#) [AXE810124](#) [FCN-214J100-G/0](#) [FCN-230C068-E/S](#) [AXE812124](#) [74220-001](#) [354184](#) [P50-028-DDS-TG](#) [53309-2471](#)