

SMD Power Inductor 0624CDMCC/DS

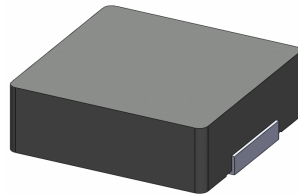

Halogen Free



Description

- Metal compound molding type construction.
- Magnetically shielded.
- Low audible core noise.
- Suitable for large current.
- L × W × H: 7.3 × 6.8 × 2.4mm Max.
- Product weight: 0.6g (Ref.)
- Moisture Sensitivity Level: 1
- RoHS compliance.
- Halogen Free available.

Dimension - [mm]

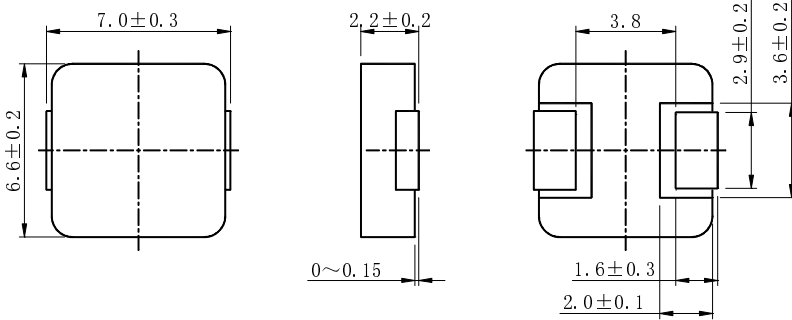

Environmental Data

- Operating temperature range: -55°C ~ +125°C (including coil's self temperature rise)
- Storage temperature range: -55°C ~ +125°C
- Solder reflow temperature: 260 °C peak.

Packaging

- Carrier tape and reel packaging.
- 1500pcs/Reel.

Land pattern and Schematics - [mm]

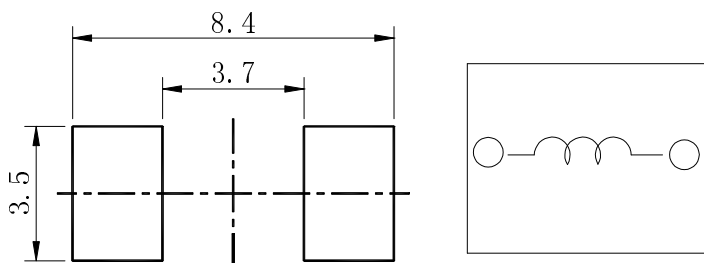

Applications

- Ideally used in notebook, ultrabook, tablet PC, LCD display, Server application.
- High current, POL converters.
- Low profile, high current power supplies.
- Battery powered devices.
- DC/DC converters in distributed power systems.



Electrical Characteristics

Part No.	Stamp	Inductance [Within] (μ H) ※1	D.C.R (m Ω) Max.(Typ.) at 25°C	Saturation Current (A) Max.(Typ.) (at 25°C) ※2	Temperature rise current (A) (Typ.) ※3
0624CDMCCDS-R22MC	R22	0.22 \pm 20%	3.0(2.5)	30.6(36.1)	22.0
0624CDMCCDS-R33MC	R33	0.33 \pm 20%	4.1(3.5)	24.2(28.5)	20.5
0624CDMCCDS-R47MC	R47	0.47 \pm 20%	5.1(4.5)	20.8(24.5)	17.5
0624CDMCCDS-R56MC	R56	0.56 \pm 20%	6.5(5.5)	17.0(20.0)	15.4
0624CDMCCDS-R68MC	R68	0.68 \pm 20%	7.0(6.2)	16.0(18.8)	15.0
0624CDMCCDS-1R0MC	1R0	1.0 \pm 20%	9.6(8.0)	13.7(16.2)	12.6
0624CDMCCDS-1R5MC	1R5	1.5 \pm 20%	19.2(16.0)	12.7(15.0)	8.7
0624CDMCCDS-2R2MC	2R2	2.2 \pm 20%	28.0(23.0)	10.9(12.8)	7.0
0624CDMCCDS-3R3MC	3R3	3.3 \pm 20%	48.0(40.0)	9.0(10.6)	5.5
0624CDMCCDS-4R7MC	4R7	4.7 \pm 20%	54.0(45.0)	6.5(7.6)	4.8
0624CDMCCDS-6R8MC	6R8	6.8 \pm 20%	66.0(55.0)	5.7(6.7)	4.2
0624CDMCCDS-100MC	100	10.0 \pm 20%	101.0(92.0)	4.7(5.5)	3.1
0624CDMCCDS-150MC	150	15.0 \pm 20%	160.0(145.0)	3.1(3.7)	2.5
0624CDMCCDS-220MC	220	22.0 \pm 20%	242.0(222.0)	2.7(3.2)	1.9

※1 Measuring frequency Inductance at 100kHz ,1.0V

※2 Saturation current: The value of DC current when the inductance is over 70% of its initial value. (at 25°C)

※3 Temperature rise current: The actual value of DC current when temperature of coil rise is

$\Delta T=40^{\circ}\text{C}$ ($T_a=25^{\circ}\text{C}$) Board conditions: FR4, Copper=70 μ m, four-layer PWB, t=1.6mm.

SMD Power Inductor 0624CDMCC/DS



Saturation Current & Temperature Rise Graph

— L (20°C) — ΔT

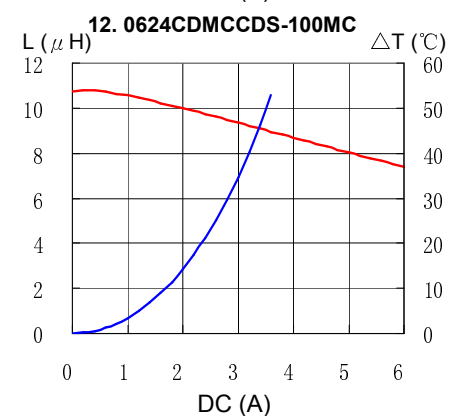
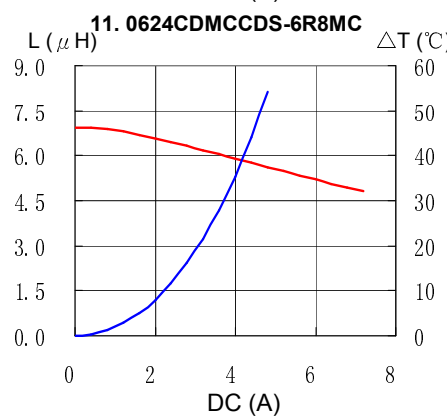
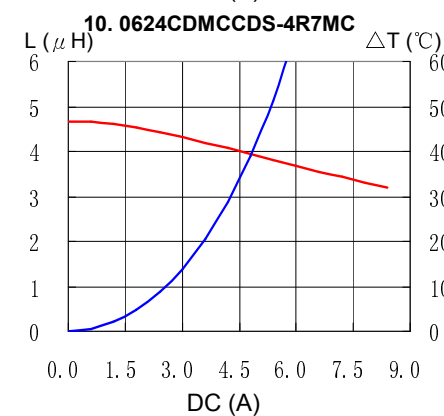
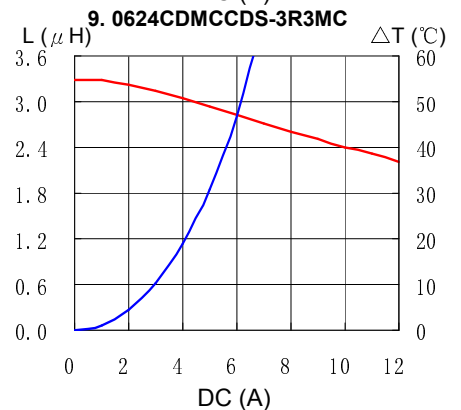
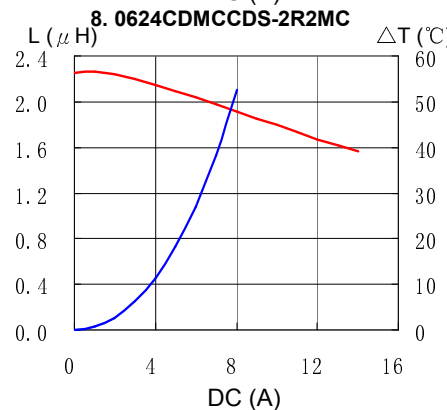
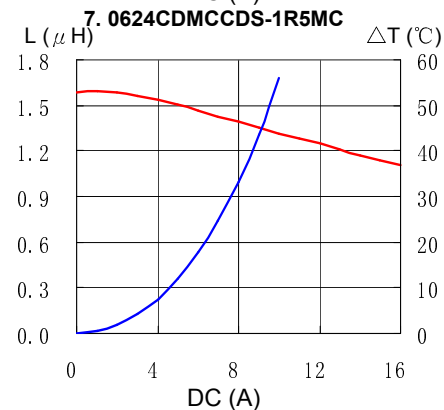
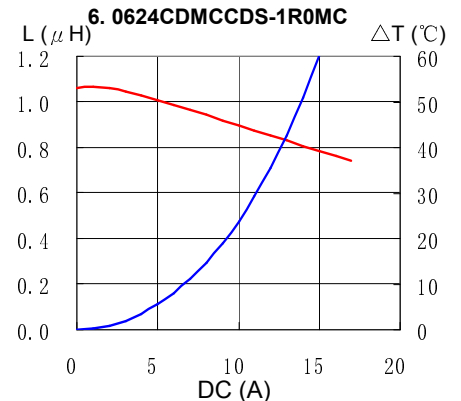
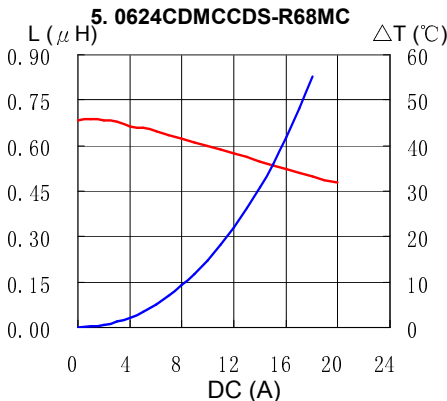
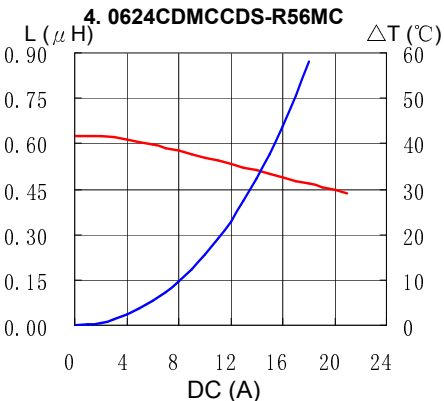
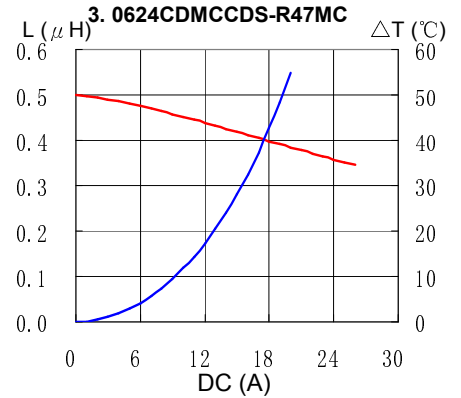
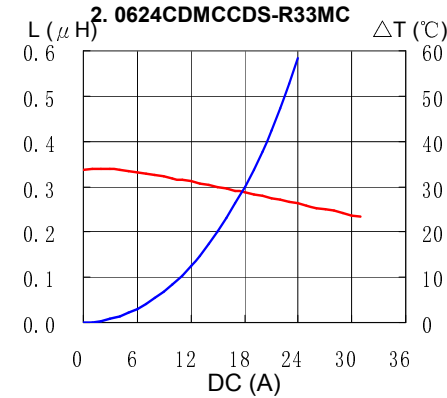
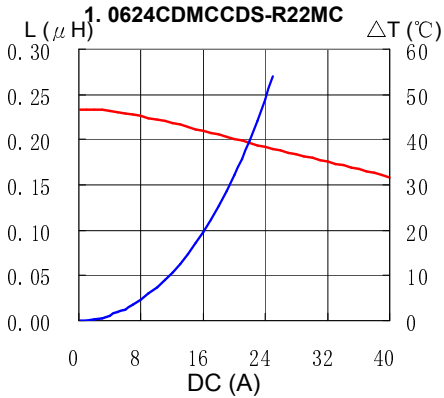

SMD Power Inductor 0624CDMCC/DS



Saturation Current & Temperature Rise Graph

— L (20°C) — ΔT

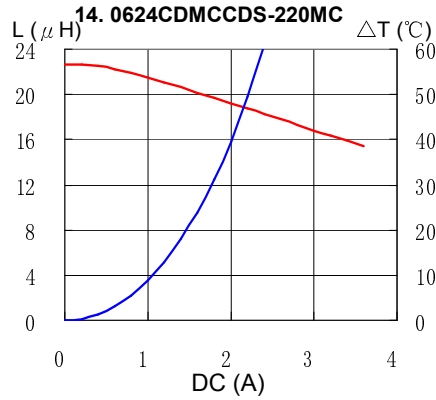
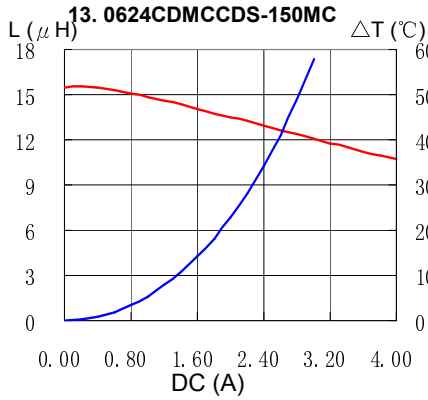

Solder Reflow Condition

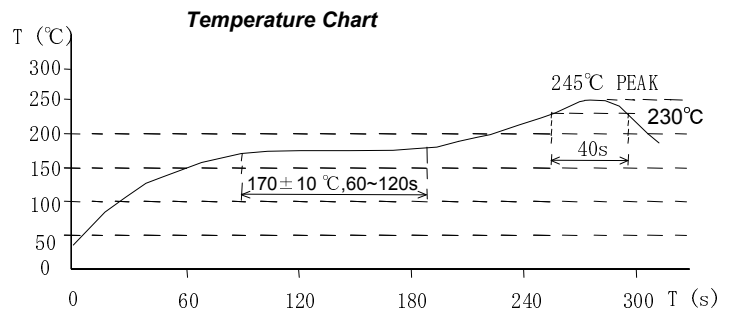
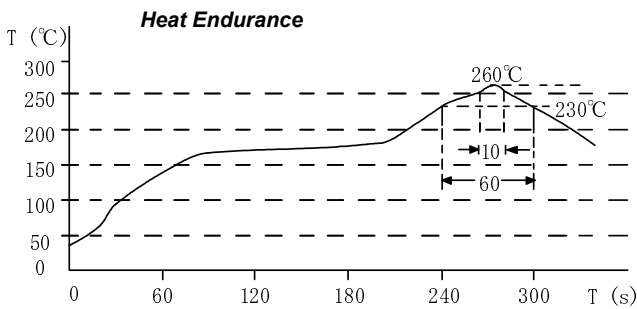

Please refer to the sales offices on our website - <http://www.sumida.com>

Hong Kong
Tel.+852-2880-6781
FAX.+852-2565-9600
sales@hk.sumida.com

Saitama(Japan)
Tel.+81-48-691-7300
FAX.+81-48-691-7340
sales@jp.sumida.com

Chicago
Tel.+1-847-545-6700
FAX. +1-847-545-6720
sales@us.sumida.com

Shanghai
Tel.+86-21-5836-3299
FAX.+86-21-5836-3266
shanghai.sales@cn.sumida.com

Seoul
Tel.+82-2-6237-0777
FAX.+82-2-6237-0778
sales@kr.sumida.com

Oberzell
Tel.+49-8591-937-0
FAX. +49-8591-937-103
contact@eu.sumida.com

Shenzhen
Tel.+86-755-8291-0228
FAX.+86-755-8291-0338
shenzhen.sales@cn.sumida.com

Singapore
Tel.+65-6296-3388
FAX.+65-6841-4426
sales@sg.sumida.com

Neumarkt
Tel.+49-9181-4509-110
FAX. +49-9181-4509-310
infocomp@eu.sumida.com

Taipei
Tel.+886-2-8751-2737
FAX.+886-2-8751-2738
sales@tw.sumida.com

San Jose
Tel.+1-408-321-9660
FAX.+1-408-321-9308
sales@us.sumida.com

X-ON Electronics

Largest Supplier of Electrical and Electronic Components

Click to view similar products for [Fixed Inductors](#) category:

Click to view products by [Sumida](#) manufacturer:

Other Similar products are found below :

[CR43NP-680KC](#) [CR54NP-820KC](#) [CR54NP-8R5MC](#) [CTX32CT-100](#) [70F224AI](#) [MGDQ4-00004-P](#) [MHL1ECTTP18NJ](#) [MHL1JCTTD12NJ](#)
[PE-51506NL](#) [PE-53601NL](#) [PE-53602NL](#) [PE-53630NL](#) [PE-53824SNLT](#) [PE-92100NL](#) [PG0434.801NLT](#) [PG0936.113NLT](#) [9310-16](#) [PM06-2N7](#) [PM06-39NJ](#) [A01TK](#) [1206CS-471XJ](#) [HC2-2R2TR](#) [HC2LP-R47-R](#) [HC3-2R2-R](#) [1206CS-151XG](#) [RCH664NP-140L](#) [RCH664NP-4R7M](#)
[RCH8011NP-221L](#) [RCP1317NP-332L](#) [RCP1317NP-391L](#) [RCR1010NP-470M](#) [RCR110DNP-331L](#) [DH2280-4R7M](#) [DS1608C-106](#) [ASPI-4020HI-R10M-T](#) [B10TJ](#) [B82477P4333M](#) [B82498B3101J000](#) [B82498B3680J000](#) [ELJ-RE27NJF2](#) [1812CS-153XJ](#) [1812CS-183XJ](#) [1812CS-223XJ](#) [1812LS-104XJ](#) [1812LS-105XJ](#) [1812LS-124XJ](#) [1812LS-154XJ](#) [1812LS-223XJ](#) [1812LS-224XJ](#) [1812LS-563XJ](#)