

SMD Power Inductor 0630CDMCD/DS

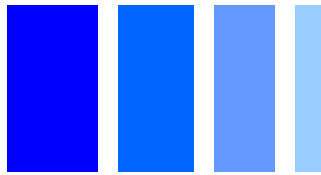

Halogen Free

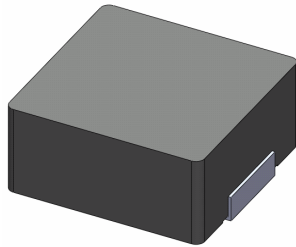

Description

- Carbonyl powder compound molding type construction.
- Magnetically shielded.
- Low audible core noise.
- Suitable for large current.
- L × W × H: 7.3 × 6.8 × 3.0mm Max.
- Product weight: 0.73g (Ref.)
- Moisture Sensitivity Level: 1
- RoHS compliance.
- Halogen Free available.

Dimension - [mm] (0.10μH、0.15μH)

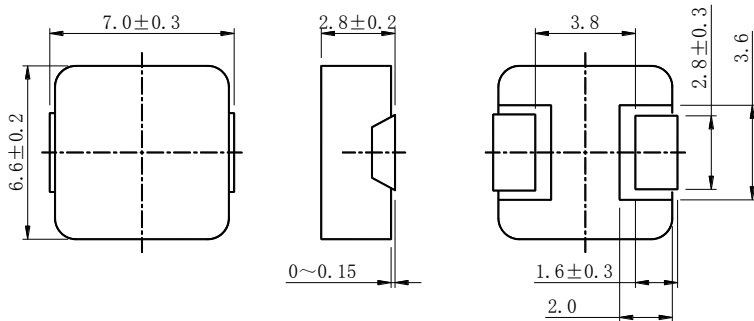

Dimension - [mm] (0.20μH~6.8μH)

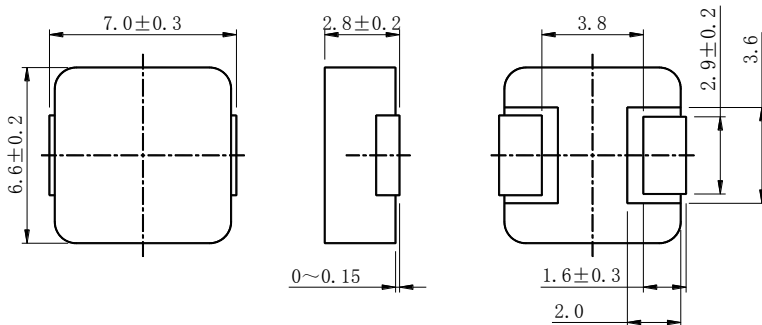

Land pattern and Schematics - [mm]

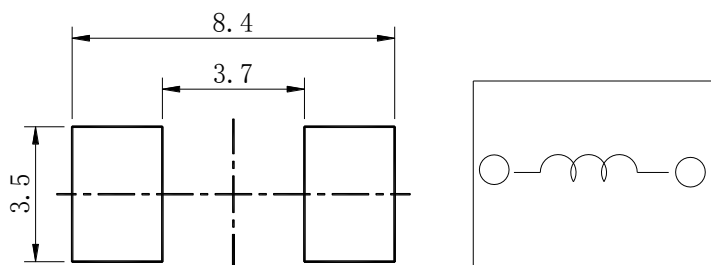

Environmental Data

- Operating temperature range: -55°C ~ +125°C (including coil's self temperature rise)
- Storage temperature range: -55°C ~ +125°C
- Solder reflow temperature: 260 °C peak.

Packaging

- Carrier tape and reel packaging.
- 1500pcs/Reel.

Applications

- Ideally used in notebook, ultrabook, tablet PC, LCD display, Server application.
- High current, POL converters.
- Low profile, high current power supplies.
- Battery powered devices.
- DC/DC converters in distributed power systems.



Electrical Characteristics

No.	品名	表示	インダクタンス (μH) [以内] ※1	D. C. R ($\text{m}\Omega$) at 25°C Max. (Typ.)	直流重畳電流 (A) (at 25°C) Max. (Typ.) ※2	温度上昇電流 (A) Typ. ※3
01	0630CDMCDDS-R10MC	R10	0.10 \pm 20%	1.7(1.5)	52.5(61.8)	32.5
02	0630CDMCDDS-R15MC	R15	0.15 \pm 20%	1.1(0.9)	47.6(56.0)	37.0
03	0630CDMCDDS-R20MC	R20	0.20 \pm 20%	3.0(2.4)	41.0(51.0)	24.0
04	0630CDMCDDS-R22MC	R22	0.22 \pm 20%	3.2(2.5)	40.0(47.5)	23.0
05	0630CDMCDDS-R33MC	R33	0.33 \pm 20%	3.9(3.5)	30.0(35.5)	20.0
06	0630CDMCDDS-R47MC	R47	0.47 \pm 20%	4.2(4.0)	24.6(29.0)	19.5
07	0630CDMCDDS-R56MC	R56	0.56 \pm 20%	5.0(4.7)	23.8(28.0)	18.8
08	0630CDMCDDS-R68MC	R68	0.68 \pm 20%	5.5(5.0)	21.8(25.6)	18.0
09	0630CDMCDDS-R75MC	R75	0.75 \pm 20%	6.2(5.4)	21.0(25.0)	17.5
10	0630CDMCDDS-R82MC	R82	0.82 \pm 20%	8.0(6.7)	20.8(24.5)	16.0
11	0630CDMCDDS-1R0MC	1R0	1.0 \pm 20%	10.0(9.0)	18.7(22.0)	13.0
12	0630CDMCDDS-1R2MC	1R2	1.2 \pm 20%	12.0(10.0)	17.8(20.9)	12.5
13	0630CDMCDDS-1R5MC	1R5	1.5 \pm 20%	15.0(14.0)	17.4(20.5)	10.2
14	0630CDMCDDS-2R0MC	2R0	2.0 \pm 20%	18.0(16.0)	14.8(17.5)	9.5
15	0630CDMCDDS-2R2MC	2R2	2.2 \pm 20%	20.0(18.0)	14.4(17.0)	9.2
16	0630CDMCDDS-2R5MC	2R5	2.5 \pm 20%	22.0(20.0)	12.0(14.0)	7.8
17	0630CDMCDDS-3R3MC	3R3	3.3 \pm 20%	30.0(28.0)	11.5(13.5)	6.3
18	0630CDMCDDS-4R7MC	4R7	4.7 \pm 20%	40.0(37.0)	10.5(12.3)	5.5
19	0630CDMCDDS-6R8MC	6R8	6.8 \pm 20%	60.0(54.0)	7.2(8.5)	4.8
20	0630CDMCDDS-100MC	100	10 \pm 20%	62.0(55.0)	4.6(5.4)	4.5

※1 Measuring frequency Inductance at 100kHz ,1.0V

※2 Saturation current: The value of DC current when the inductance is over 80% of its initial value.

※3 Temperature rise current: The actual value of DC current when temperature of coil rise is $\Delta T=40^\circ\text{C}$ ($T_a=25^\circ\text{C}$) Board conditions: FR4, Copper=70 μm , four-layer PWB, t=1.6mm.

SMD Power Inductor 0630CDMCD/DS



Saturation Current & Temperature Rise Graph

— L (20°C) — ΔT

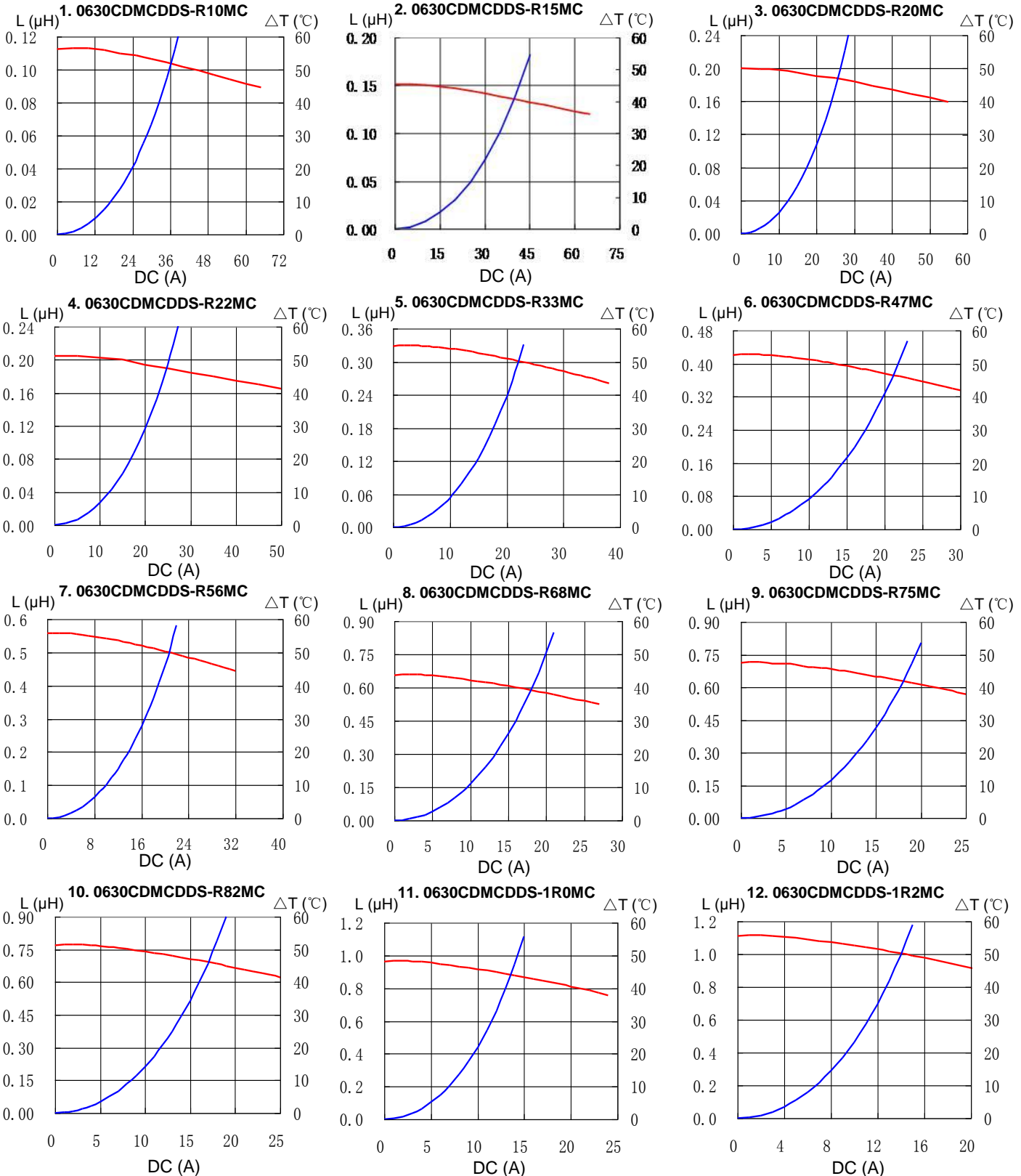

SMD Power Inductor 0630CDMCD/DS



Saturation Current & Temperature Rise Graph

— L (20°C) — ΔT

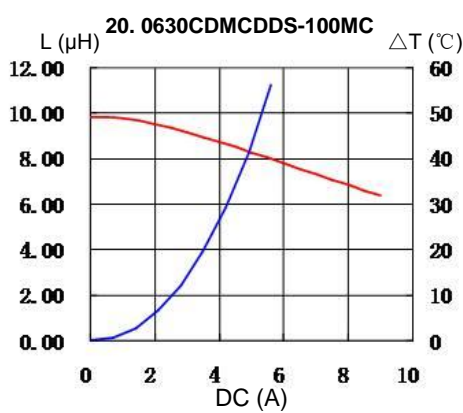
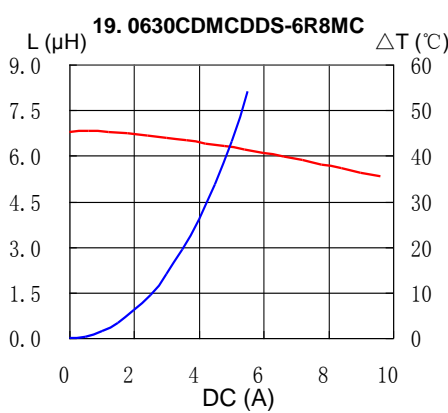
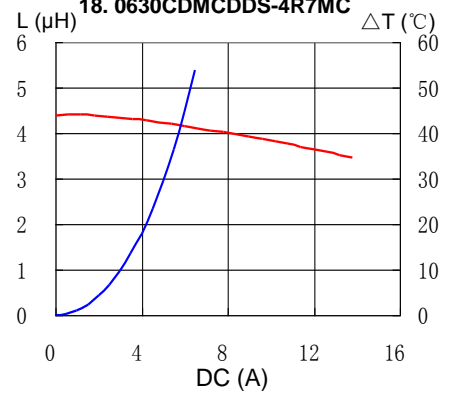
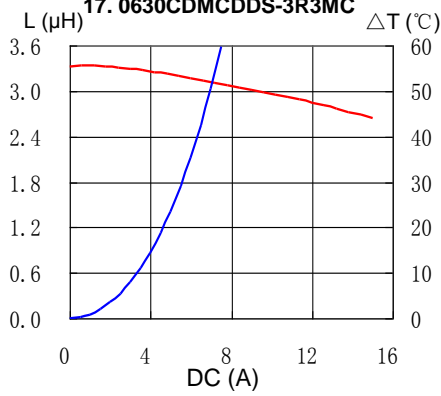
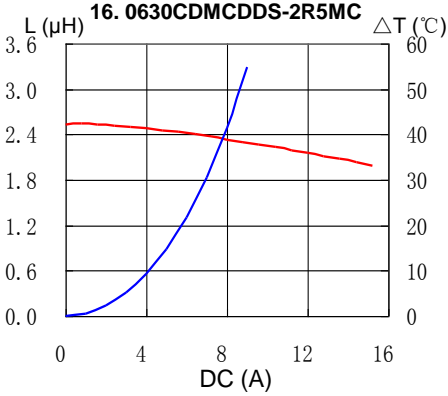
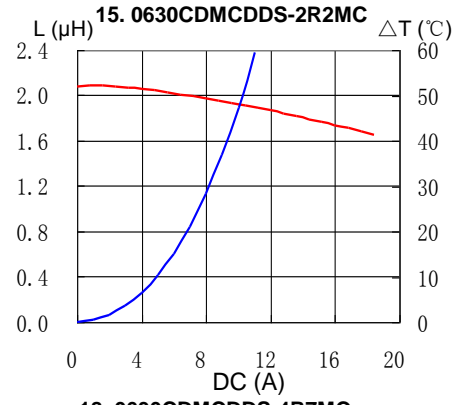
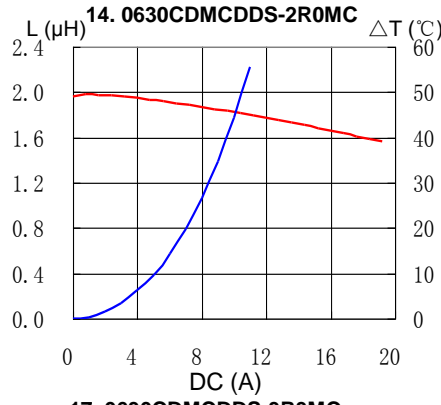
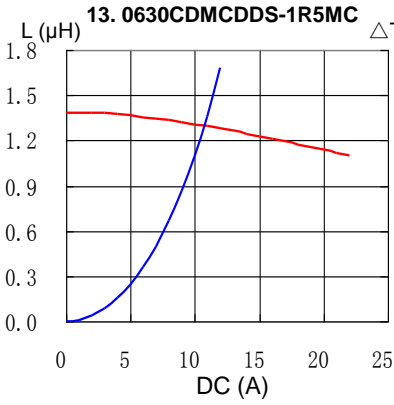

SMD Power Inductor 0630CDMCD/DS



Solder Reflow Condition

Heat Endurance

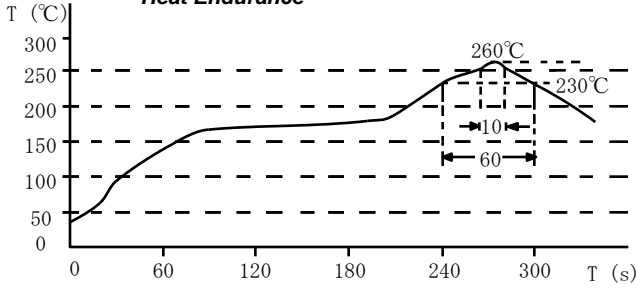

Temperature Chart

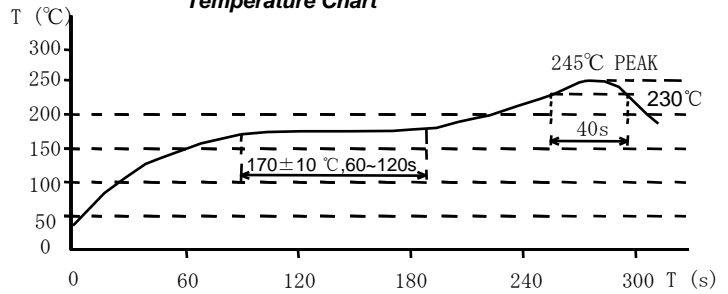

Please refer to the sales offices on our website - <http://www.sumida.com>

Hong Kong

Tel.+852-2880-6781
FAX.+852-2565-9600
sales@hk.sumida.com

Saitama(Japan)

Tel.+81-48-691-7300
FAX.+81-48-691-7340
sales@jp.sumida.com

Chicago

Tel.+1-847-545-6700
FAX. +1-847-545-6720
sales@us.sumida.com

Shanghai

Tel.+86-21-5836-3299
FAX.+86-21-5836-3266
shanghai.sales@cn.sumida.com

Seoul

Tel.+82-2-6237-0777
FAX.+82-2-6237-0778
sales@kr.sumida.com

Obernzell

Tel.+49-8591-937-0
FAX. +49-8591-937-103
contact@eu.sumida.com

Shenzhen

Tel.+86-755-8291-0228
FAX.+86-755-8291-0338
shenzhen.sales@cn.sumida.com

Singapore

Tel.+65-6296-3388
FAX.+65-6841-4426
sales@sg.sumida.com

Neumarkt

Tel.+49-9181-4509-110
FAX. +49-9181-4509-310
infocomp@eu.sumida.com

Taipei

Tel.+886-2-8751-2737
FAX.+886-2-8751-2738
sales@tw.sumida.com

San Jose

Tel.+1-408-321-9660
FAX.+1-408-321-9308
sales@us.sumida.com

X-ON Electronics

Largest Supplier of Electrical and Electronic Components

Click to view similar products for [Fixed Inductors](#) category:

Click to view products by [Sumida](#) manufacturer:

Other Similar products are found below :

[CR43NP-680KC](#) [CR54NP-820KC](#) [CR54NP-8R5MC](#) [CTX32CT-100](#) [70F224AI](#) [MGDQ4-00004-P](#) [MHL1ECTTP18NJ](#) [MHL1JCTTD12NJ](#)
[PE-51506NL](#) [PE-53601NL](#) [PE-53602NL](#) [PE-53630NL](#) [PE-53824SNLT](#) [PE-92100NL](#) [PG0434.801NLT](#) [PG0936.113NLT](#) [9310-16](#) [PM06-2N7](#) [PM06-39NJ](#) [A01TK](#) [1206CS-471XJ](#) [HC2-2R2TR](#) [HC2LP-R47-R](#) [HC3-2R2-R](#) [1206CS-151XG](#) [RCH664NP-140L](#) [RCH664NP-4R7M](#)
[RCH8011NP-221L](#) [RCP1317NP-332L](#) [RCP1317NP-391L](#) [RCR1010NP-470M](#) [RCR110DNP-331L](#) [DH2280-4R7M](#) [DS1608C-106](#) [ASPI-4020HI-R10M-T](#) [B10TJ](#) [B82477P4333M](#) [B82498B3101J000](#) [B82498B3680J000](#) [ELJ-RE27NJF2](#) [1812CS-153XJ](#) [1812CS-183XJ](#) [1812CS-223XJ](#) [1812LS-104XJ](#) [1812LS-105XJ](#) [1812LS-124XJ](#) [1812LS-154XJ](#) [1812LS-223XJ](#) [1812LS-224XJ](#) [1812LS-563XJ](#)