

SMD Power Inductor

201610CDMCD/DS



Description

- Metal compound molding type construction
- Magnetically shielded
- Low audible core noise
- Suitable for large current.
- LxWxH:2.2x1.8x1.0mm Max.
- Product weight: 28mg (Ref.)
- Moisture Sensitivity Level: 1

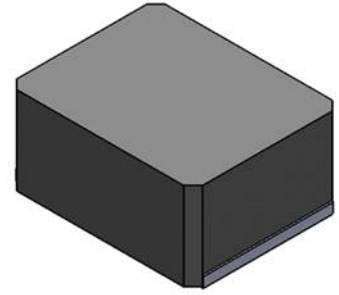

Environmental Data

- Operating temperature range: -55°C~+125°C (including coil's self temperature rise)
- Storage temperature range: -55°C~+125°C

Packaging

- Carrier tape and reel packaging.
- 3000Pcs per reel

Applications

- DC/DC converter for CPU in Notebook PC. Smartphones, LCD displays, HDDs, DVDs, DVCs, DSCs, PDAs ect..
- Thin type on-board power supply module for exchanger VRM for server.
- Low profile, high current power supplies.
- Battery powered devices.

Dimension - [mm]

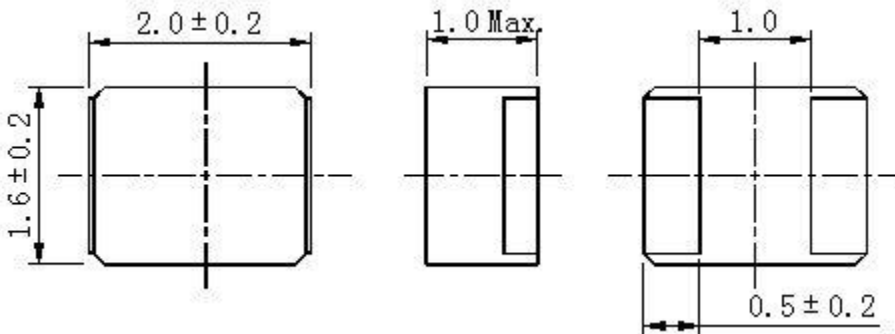

Recommended Land pattern - [mm]

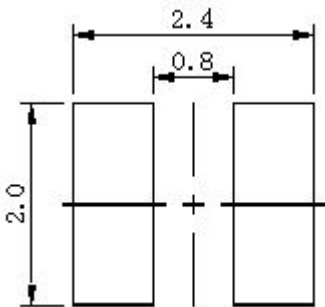

Wire Connection

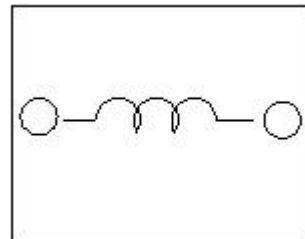

SMD Power Inductor

201610CDMCD/DS



Electrical Characteristics

Part Number	Inductance [Within] (μ H) ※1	D.C.R. at 20°C Max.(Typ.) (m Ω)	Saturation Current (A) Max.(Typ.) ※2	Temperature Rise Current (A) Max.(Typ.) ※3
201610CDMCDDS-R24MC	0.24 \pm 20%	20.00 (16.00)	6.10 (7.20)	(6.30)
201610CDMCDDS-R47MC	0.47 \pm 20%	32.00 (26.00)	4.80 (5.30)	(4.60)
201610CDMCDDS-R68MC	0.68 \pm 20%	43.00 (36.00)	3.60 (4.20)	(4.20)
201610CDMCDDS-1R0MC	1.00 \pm 20%	57.00 (48.00)	3.00 (3.50)	(3.30)

※1 Measuring frequency Inductance at 1MHz,0.1V

※2 Saturation current: This indicates the actual value of D.C. current when the inductance becomes 30% lower than its initial value.

※3 Temperature rise current: The actual value of D.C. current when the temperature of coil becomes $\Delta T=40^{\circ}\text{C}$ ($T_a=25^{\circ}\text{C}$).(Test board condition: FR4, Copper= $70\mu\text{m}$, four-layer PWB $t=1.6\text{mm}$)

Solder Reflow Condition

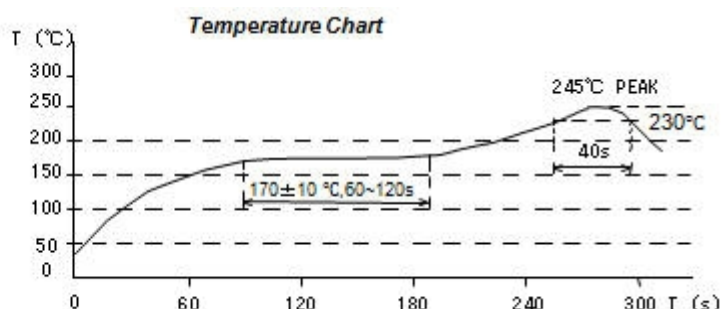
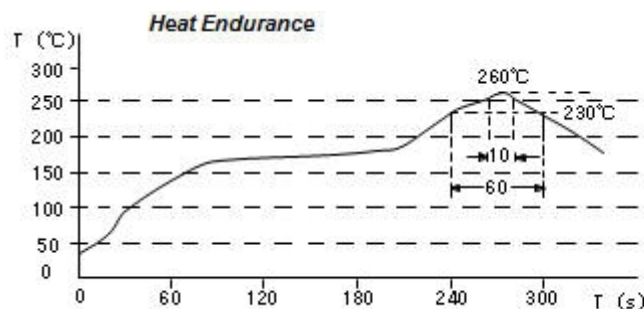

SMD Power Inductor

201610CDMCD/DS



Saturation Current & Temperature Rise Graph

— L (20°C) — ΔT

1. 201610CDMCDDS-R24MC

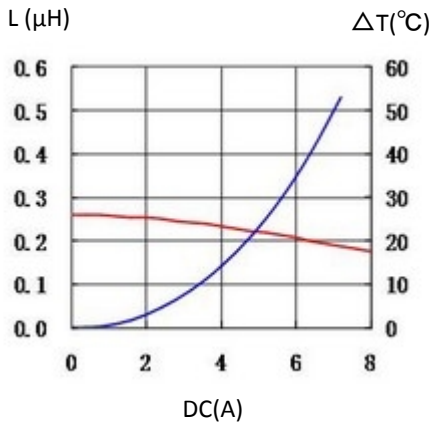

2. 201610CDMCDDS-R47MC

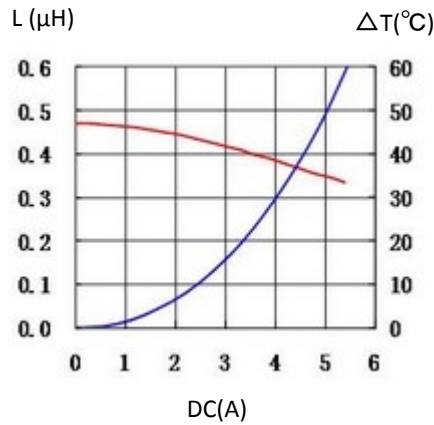

3. 201610CDMCDDS-R68MC

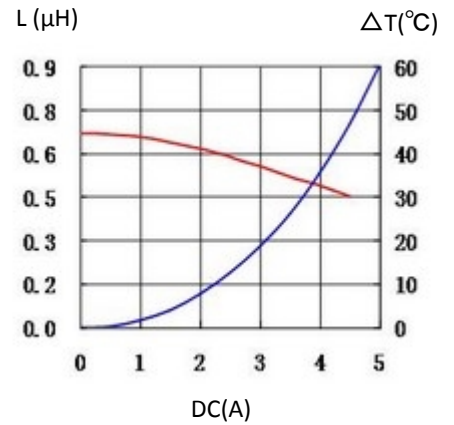

4. 201610CDMCDDS-1R0MC

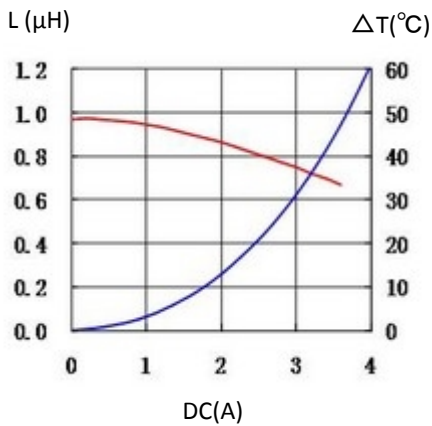

For sales office information, please [click here](#) to visit our website.

X-ON Electronics

Largest Supplier of Electrical and Electronic Components

Click to view similar products for [Power Inductors - SMD category](#):

Click to view products by [Sumida manufacturer](#):

Other Similar products are found below :

[SPD62R-472M](#) [LLQPB201214T1R0M](#) [LLXND3030QKT470MNG](#) [LLQPB160807T4R7M](#) [LLAPB2016KKTR33M](#)
[LBXND4040TKL330MDG](#) [LLXNE3030KKT4R7MN](#) [LSQEA201212T100M](#) [IHLP5050CEER4R7M06](#) [LVS505020-1R0T-N](#) [LVS505040-1R2T-N](#) [LVS606020-1R5M-N](#) [LVS606028-6R8M-N](#) [LVS606045-102M-N](#) [LVS606045-150M-N](#) [LVS606045-1R8M-N](#) [LVS606045-6R8M-N](#) [LVS808040-2R0M-N](#) [LVS808040-330M-N](#) [LVS808040-4R7M-N](#) [MHCI06030-R56M-R8](#) [SCD0403T-470M-N](#) [SCD0403T-6R8K-N](#) [SCD0504T-101M-N](#) [SCD0504T-120M-N](#) [SCD0504T-221M-N](#) [SCD0504T-470M-N](#) [SCD0504T-471M-N](#) [SCD0705T-180M-N](#) [SCD0705T-221M-N](#) [SCD0705T-470M-N](#) [SCD1005T-101M-N](#) [SCD1005T-221M-N](#) [SCD1005T-470M-N](#) [SSL1306T-101M-N](#) [LQB15NNR27K10D](#) [201610CDMCDDS-R47MC](#) [201610CDMCDDS-1R0MC](#) [201610CDMCDDS-R68MC](#) [LSQPB201210T220M](#) [LBCNF2012KKTR24MA](#) [LSQEA201212T220K](#) [LSENC2016KKT1R0M](#) [LSBHB1608KKT2R2MG](#) [LSQPB160807T2R2M](#) [LSQEA201212T101K](#) [LCXND4040MKL4R7MDG](#) [DEM8045Z-5R6N=P3](#) [LCXNH8080YKL101MJG](#) [LSCNA2012KKT1R0MA](#)