

SMD Power Inductor CD30D22

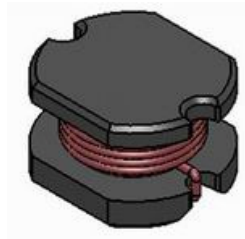

Halogen Free



Description

- Ferrite drum core construction.
- Magnetically unshielded.
- L × W × H: 3.8 × 3.3 × 2.5mm Max.
- Product weight : 0.07g (Ref.)
- Moisture Sensitivity Level: 1
- RoHS compliance.
- Halogen Free available.

Dimension - [mm]

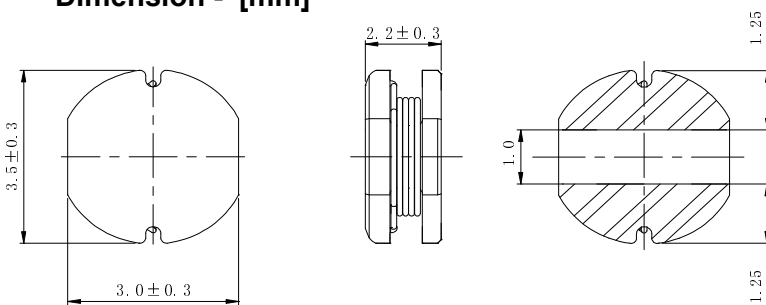

Environmental Data

- Operating temperature range: $-40^{\circ}\text{C} \sim +125^{\circ}\text{C}$ (including coil's self temperature rise)
- Storage temperature range: $-40^{\circ}\text{C} \sim +125^{\circ}\text{C}$
- Solder reflow temperature: 260°C peak.

Packaging

- Carrier tape and reel packaging.
- 13.0" diameter reel
- 3000pcs per reel

Land pattern and Schematics - [mm]

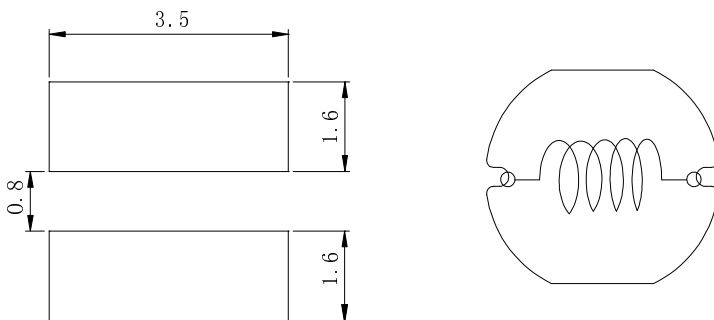

Applications

- Ideally used in Mobilephone, PDA, MP3, DSC/DVC, portable DVD etc as DC-DC Converter inductors.

SMD Power Inductor CD30D22



Electrical Characteristics

Part No.	Stamp	Inductance [μ H] [Within] ※1	D.C.R. (Ω) [Max.] (Typ.) (at 25°C)	Saturation current (A) [Max.] (Typ.) (at 25°C) ※2	Temperature rise current (A) ※3
CD30D22HF-1R0MC	B	1.0 \pm 20%	35.9m (28.7m)	3.36 (4.20)	3.46
CD30D22HF-1R5MC	C	1.5 \pm 20%	48.7m (38.9m)	2.80 (3.50)	3.00
CD30D22HF-2R2MC	D	2.2 \pm 20%	69.4m (55.5m)	2.08 (2.60)	2.00
CD30D22HF-3R3MC	E	3.3 \pm 20%	111m (88.7m)	1.76 (2.20)	1.56
CD30D22HF-4R7MC	F	4.7 \pm 20%	140m (112m)	1.49 (1.86)	1.42
CD30D22HF-5R6MC	G	5.6 \pm 20%	153m (122m)	1.36 (1.70)	1.35
CD30D22HF-6R8MC	H	6.8 \pm 20%	172m (137m)	1.28 (1.60)	1.28
CD30D22HF-8R2MC	J	8.2 \pm 20%	265m (212m)	1.14 (1.42)	0.97
CD30D22HF-100MC	K	10 \pm 20%	313m (250m)	1.02 (1.28)	0.95
CD30D22HF-120MC	L	12 \pm 20%	338m (270m)	0.96 (1.20)	0.91
CD30D22HF-150MC	M	15 \pm 20%	388m (310m)	0.83 (1.04)	0.83
CD30D22HF-180MC	N	18 \pm 20%	507m (405m)	0.80 (1.00)	0.70
CD30D22HF-220MC	P	22 \pm 20%	643m (514m)	0.69 (0.86)	0.66
CD30D22HF-270MC	Q	27 \pm 20%	730m (584m)	0.65 (0.81)	0.58
CD30D22HF-330MC	R	33 \pm 20%	915m (732m)	0.57 (0.71)	0.49
CD30D22HF-390MC	S	39 \pm 20%	1.07 (851m)	0.51 (0.64)	0.48
CD30D22HF-470MC	T	47 \pm 20%	1.23 (980m)	0.49 (0.62)	0.39
CD30D22HF-680MC	U	68 \pm 20%	1.82 (1.51)	0.41 (0.51)	0.37
CD30D22HF-101MC	V	100 \pm 20%	2.79 (2.32)	0.33 (0.41)	0.30
CD30D22HF-151MC	X	150 \pm 20%	4.62 (3.85)	0.26 (0.33)	0.22
CD30D22HF-221MC	Y	220 \pm 20%	5.94 (4.95)	0.23 (0.29)	0.19

※1 Measuring frequency: 100 kHz 1V

※2 Saturation current: This indicates the value of D.C. current when the inductance becomes 10% lower than its initial value.

※3 Temperature rise current: The actual value of D.C. current when the temperature of coil becomes $\Delta T=40^{\circ}\text{C}$ ($T_a=20^{\circ}\text{C}$).

SMD Power Inductor CD30D22

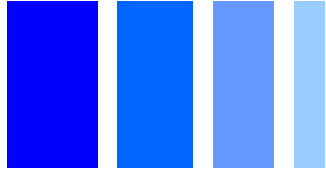

Saturation Current & Temperature Rise Graph

— L (25°C) — ΔT

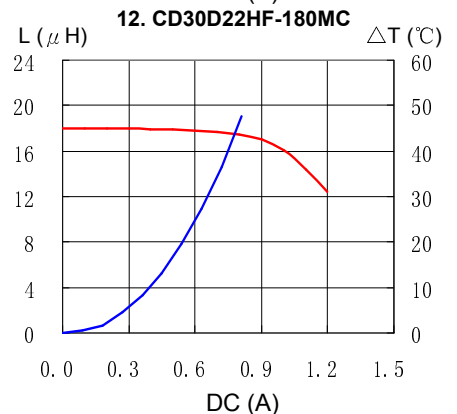
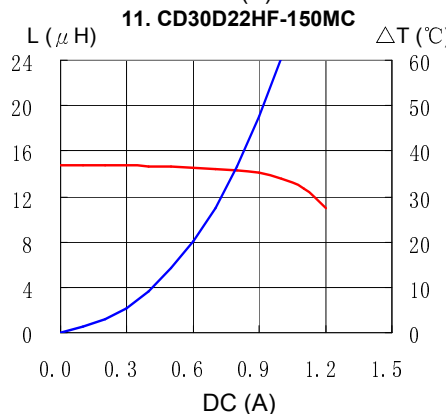
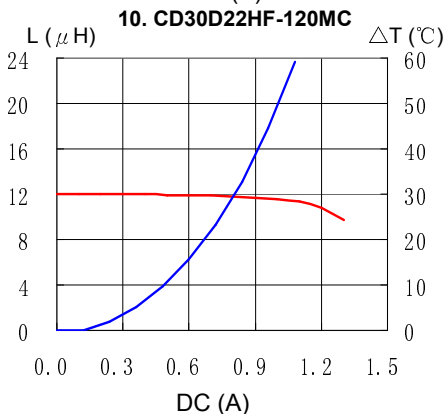
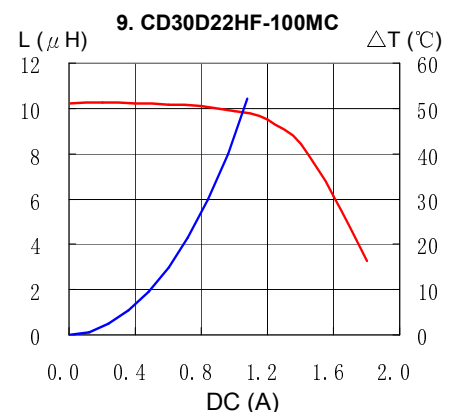
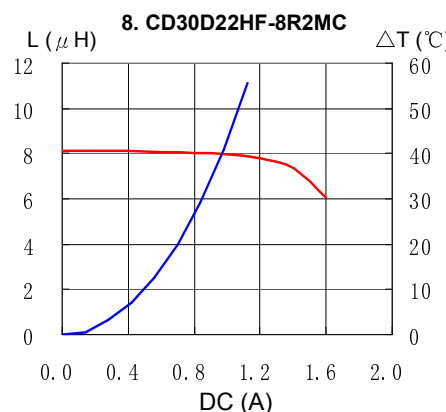
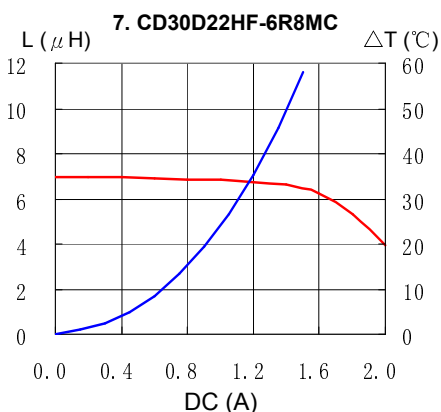
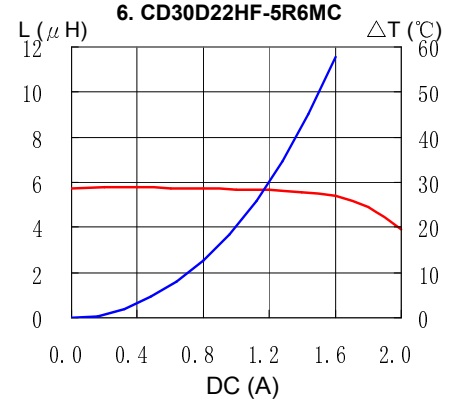
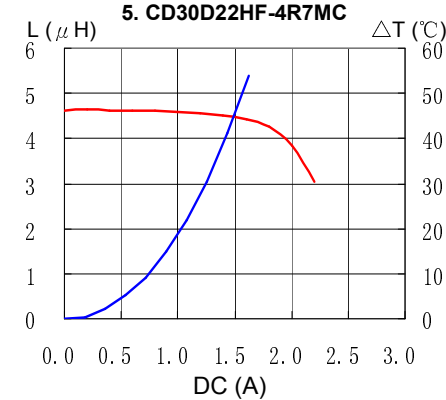
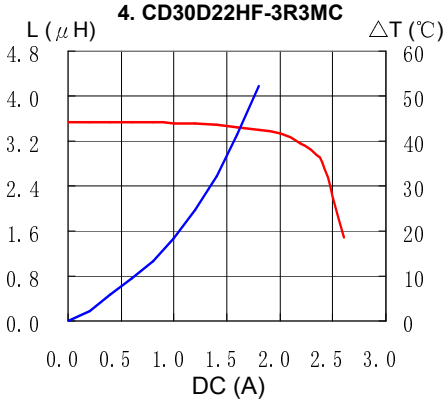
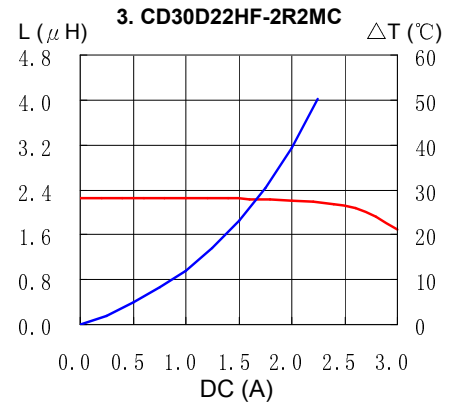
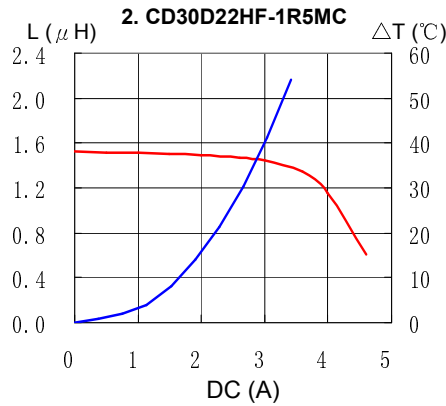
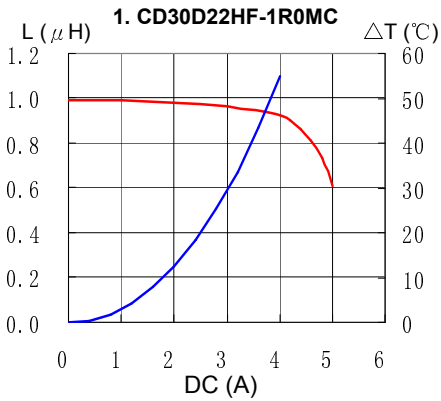

SMD Power Inductor CD30D22



Saturation Current & Temperature Rise Graph

— L (25°C) — ΔT

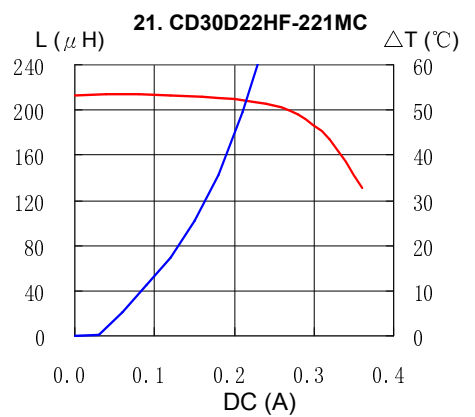
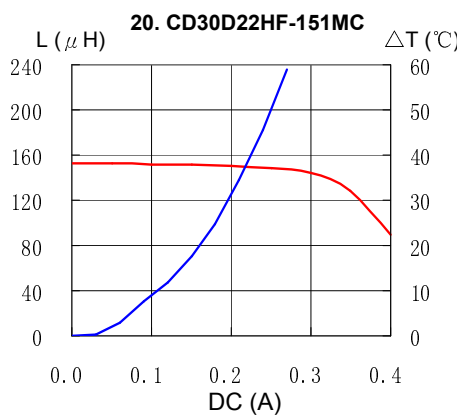
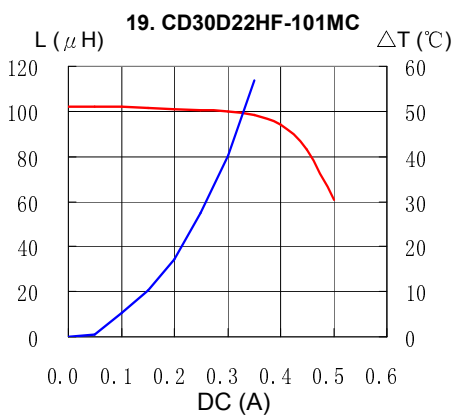
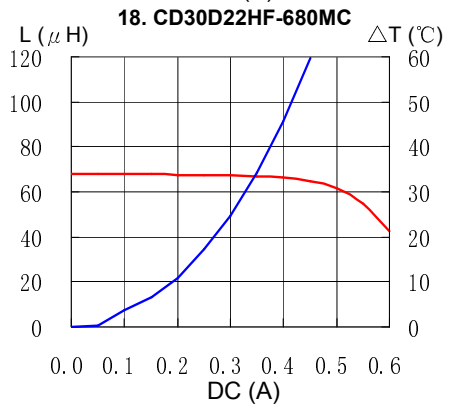
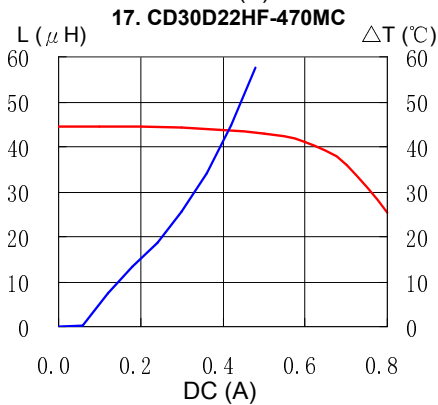
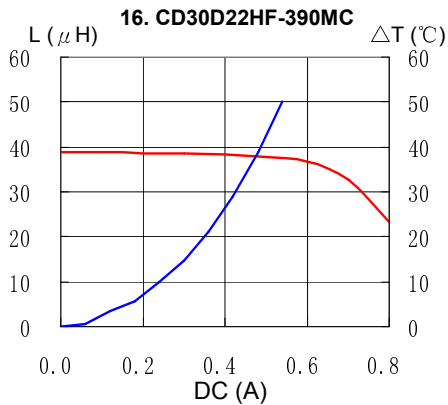
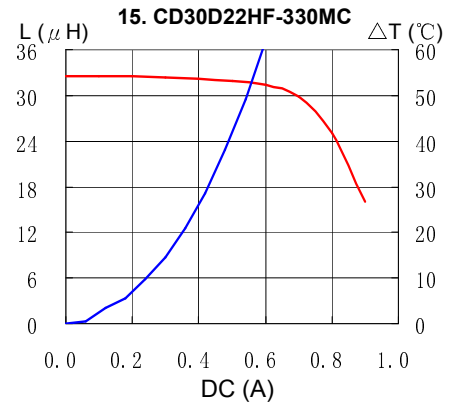
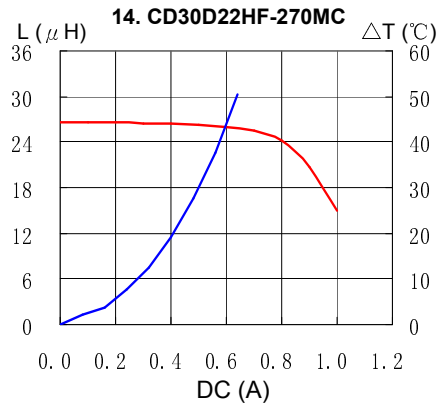
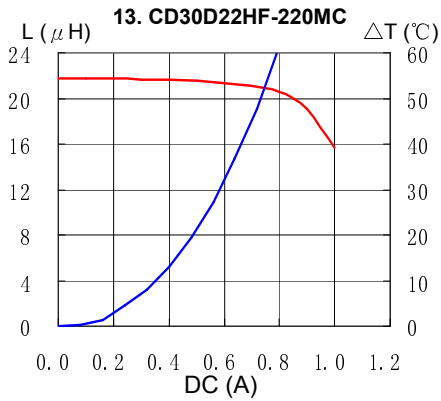

SMD Power Inductor CD30D22



Solder Reflow Condition

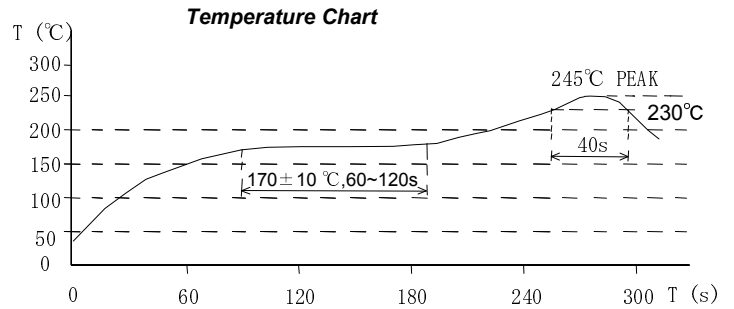

Please refer to the sales offices on our website - <http://www.sumida.com>

Hong Kong

Tel.+852-2880-6781
FAX.+852-2565-9600
sales@hk.sumida.com

Saitama(Japan)

Tel.+81-48-691-7300
FAX.+81-48-691-7340
sales@jp.sumida.com

Chicago

Tel.+1-847-545-6700
FAX. +1-847-545-6720
sales@us.sumida.com

Shanghai

Tel.+86-21-5836-3299
FAX.+86-21-5836-3266
shanghai.sales@cn.sumida.com

Seoul

Tel.+82-2-6237-0777
FAX.+82-2-6237-0778
sales@kr.sumida.com

Oberzell

Tel.+49-8591-937-0
FAX. +49-8591-937-103
contact@eu.sumida.com

Shenzhen

Tel.+86-755-8291-0228
FAX.+86-755-8291-0338
shenzhen.sales@cn.sumida.com

Singapore

Tel.+65-6296-3388
FAX.+65-6841-4426
sales@sg.sumida.com

Neumarkt

Tel.+49-9181-4509-110
FAX. +49-9181-4509-310
infocomp@eu.sumida.com

Taipei

Tel.+886-2-8751-2737
FAX.+886-2-8751-2738
sales@tw.sumida.com

San Jose

Tel.+1-408-321-9660
FAX.+1-408-321-9308
sales@us.sumida.com

X-ON Electronics

Largest Supplier of Electrical and Electronic Components

Click to view similar products for [Fixed Inductors](#) category:

Click to view products by [Sumida](#) manufacturer:

Other Similar products are found below :

[CR43NP-680KC](#) [CR54NP-820KC](#) [CR54NP-8R5MC](#) [CTX32CT-100](#) [70F224AI](#) [MGDQ4-00004-P](#) [MHL1ECTTP18NJ](#) [MHL1JCTTD12NJ](#)
[PE-51506NL](#) [PE-53601NL](#) [PE-53602NL](#) [PE-53630NL](#) [PE-53824SNLT](#) [PE-92100NL](#) [PG0434.801NLT](#) [PG0936.113NLT](#) [9310-16](#) [PM06-2N7](#) [PM06-39NJ](#) [A01TK](#) [1206CS-471XJ](#) [HC2-2R2TR](#) [HC2LP-R47-R](#) [HC3-2R2-R](#) [1206CS-151XG](#) [RCH664NP-140L](#) [RCH664NP-4R7M](#)
[RCH8011NP-221L](#) [RCP1317NP-332L](#) [RCP1317NP-391L](#) [RCR1010NP-470M](#) [RCR110DNP-331L](#) [DH2280-4R7M](#) [DS1608C-106](#) [ASPI-4020HI-R10M-T](#) [B10TJ](#) [B82477P4333M](#) [B82498B3101J000](#) [B82498B3680J000](#) [ELJ-RE27NJF2](#) [1812CS-153XJ](#) [1812CS-183XJ](#) [1812CS-223XJ](#) [1812LS-104XJ](#) [1812LS-105XJ](#) [1812LS-124XJ](#) [1812LS-154XJ](#) [1812LS-223XJ](#) [1812LS-224XJ](#) [1812LS-563XJ](#)