

# SMD Power Inductor

## CD4018MB/DS



Recommended Type

### Description

- Ferrite core construction
- Low profile resin-shielded
- LxWxH: 4.2x4.2x1.8mm Max.
- Product weight: 0.105g(Ref.)
- Moisture Sensitivity Level: 1

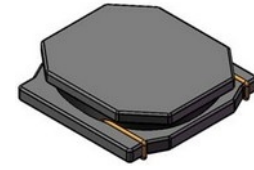

### Environmental Data

- Operating temperature range: -40°C~+105°C (including coil's self temperature rise)
- Storage temperature range: -40°C~+105°C

### Packaging

- Carrier tape and reel packaging
- 3000pcs per reel

### Applications

- DC/DC converter for CPU in notebook PC, smartphones, LCD displays, HDDs, DVDs, SSDs, DVCs, DSCs, PDAs etc.

### Dimension - [mm]

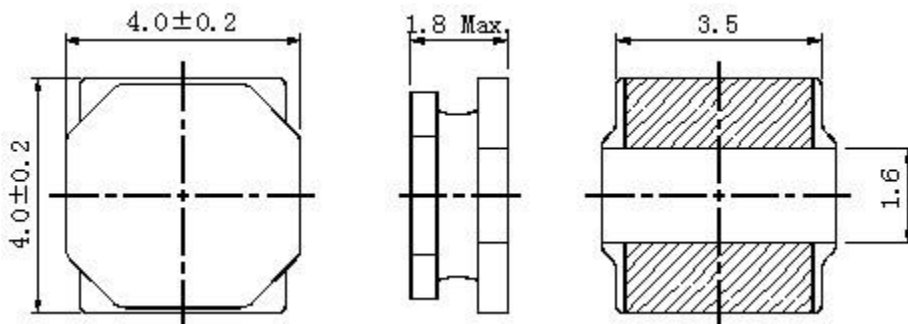

### Recommended Land pattern - [mm]

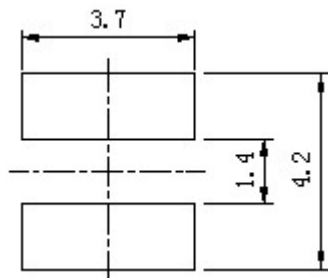

### Wire Connection

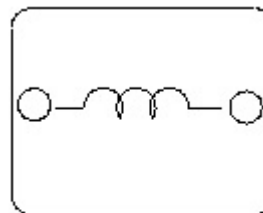

# SMD Power Inductor

## CD4018MB/DS



### Electrical Characteristics

Part Number	Inductance [Within] ( $\mu$ H) ※1	D.C.R. at 20°C Max.(Typ.) (m $\Omega$ )	Saturation Current (A) Max.(Typ.) ※2	Temperature Rise Current (A) Max.(Typ.) ※3
CD4018MBDS-1R0NC	1.00 $\pm$ 30%	32.00 (27.00)	4.20 (4.90)	(3.20)
CD4018MBDS-1R5NC	1.50 $\pm$ 30%	42.00 (35.00)	3.30 (3.90)	(2.70)
CD4018MBDS-2R2MC	2.20 $\pm$ 20%	61.00 (51.00)	2.90 (3.40)	(2.20)
CD4018MBDS-3R3MC	3.30 $\pm$ 20%	85.00 (71.00)	2.30 (2.70)	(2.00)
CD4018MBDS-4R7MC	4.70 $\pm$ 20%	114 (95.00)	2.00 (2.40)	(1.60)
CD4018MBDS-6R8MC	6.80 $\pm$ 20%	148 (123)	1.70 (2.00)	(1.40)
CD4018MBDS-100MC	10.00 $\pm$ 20%	208 (173)	1.40 (1.60)	(1.20)
CD4018MBDS-150MC	15.00 $\pm$ 20%	296 (247)	1.10 (1.30)	(1.00)
CD4018MBDS-220MC	22.00 $\pm$ 20%	400 (333)	0.90 (1.05)	(0.92)
CD4018MBDS-330MC	33.00 $\pm$ 20%	658 (548)	0.67 (0.79)	(0.70)
CD4018MBDS-470MC	47.00 $\pm$ 20%	845 (704)	0.62 (0.73)	(0.62)

※1 Measuring frequency inductance at 100kHz 1V.

※2 Saturation current: This indicates the value of D.C. current when the inductance becomes 30% lower than its initial value.

※3 Temperature rise current: The actual value of D.C. current when the temperature of coil becomes  $\Delta T=40^{\circ}\text{C}$  ( $T_a=25^{\circ}\text{C}$ ).

### Solder Reflow Condition

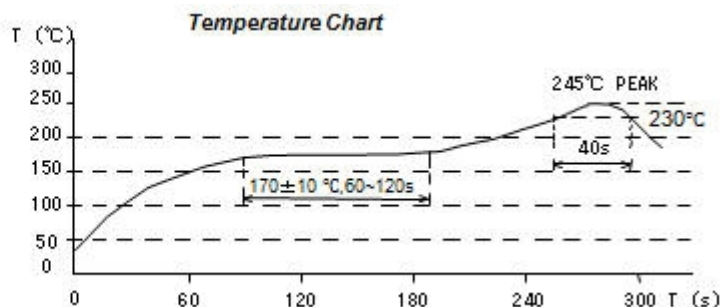
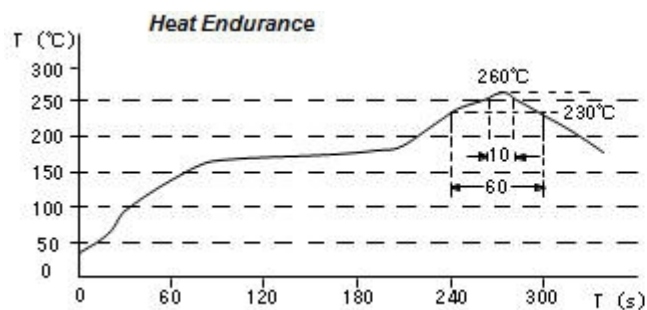

# SMD Power Inductor

## CD4018MB/DS



### Saturation Current & Temperature Rise Graph

— L (20°C) —  $\Delta T$

1. CD4018MBDS-1R0NC

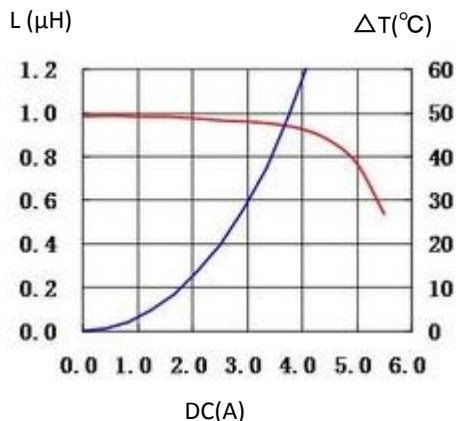

2. CD4018MBDS-1R5NC

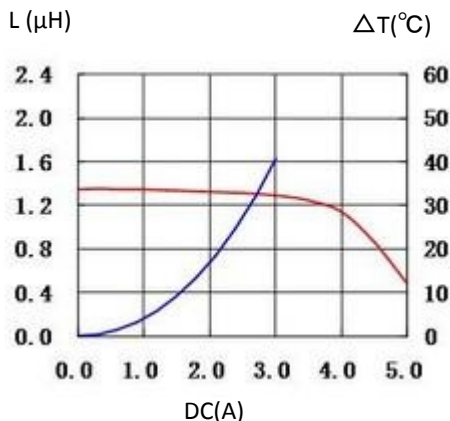

3. CD4018MBDS-2R2MC

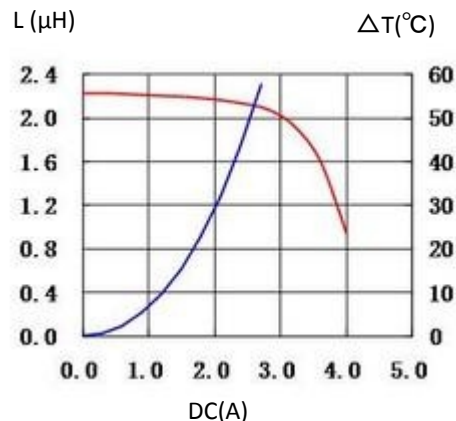

4. CD4018MBDS-3R3MC

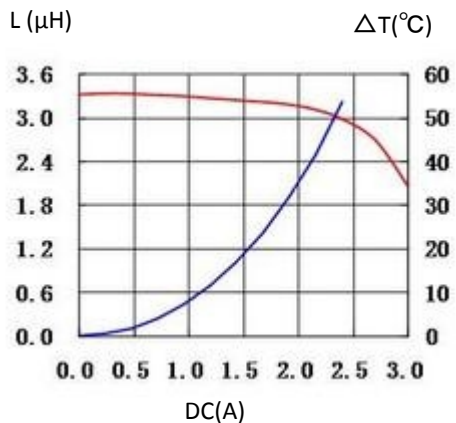

5. CD4018MBDS-4R7MC

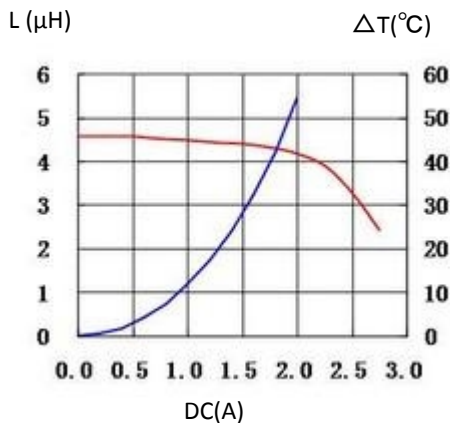

6. CD4018MBDS-6R8MC

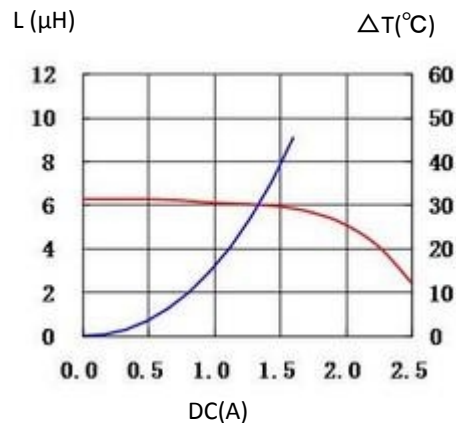

7. CD4018MBDS-100MC

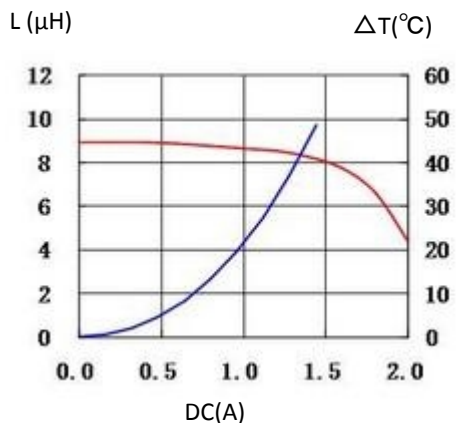

8. CD4018MBDS-150MC

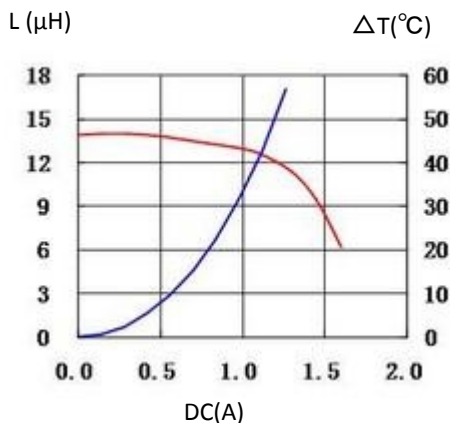

9. CD4018MBDS-220MC

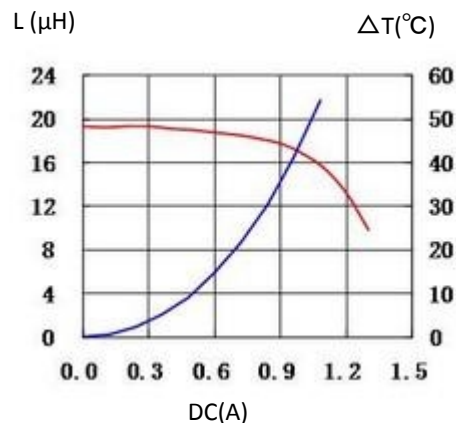

Note: This specification is subject to change without notice. Please contact your nearest sales office for updated information when placing an order.

# SMD Power Inductor

## CD4018MB/DS



Recommended Type

10. CD4018MBDS-330MC

11. CD4018MBDS-470MC

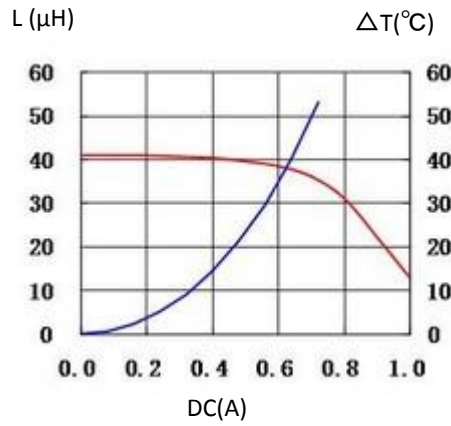
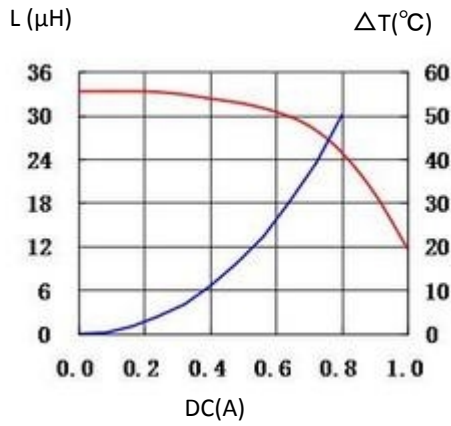

For sales office information, please [click here](#) to visit our website.

## X-ON Electronics

Largest Supplier of Electrical and Electronic Components

*Click to view similar products for [Fixed Inductors](#) category:*

*Click to view products by [Sumida](#) manufacturer:*

Other Similar products are found below :

[CR32NP-100KC](#) [70F224AI](#) [MHQ1005P10NJ](#) [MHQ1005P1N0S](#) [MHQ1005P2N4S](#) [MHQ1005P3N6S](#) [MHQ1005P5N1S](#) [MHQ1005P8N2J](#)  
[PE-53601NL](#) [PE-53602NL](#) [PG0936.113NLT](#) [9220-20](#) [9310-16](#) [PM06-2N7](#) [PM06-39NJ](#) [A01TK](#) [1206CS-471XJ](#) [HC2-R47-R](#) [HC8-1R2-R](#)  
[HCF1305-3R3-R](#) [1206CS-151XG](#) [RCH664NP-4R7M](#) [RCP1317NP-391L](#) [DH2280-4R7M](#) [DS1608C-106](#) [B10TJ](#) [B82498B3101J000](#) [ELJ-](#)  
[RE27NJF2](#) [1812CS-153XJ](#) [1812CS-183XJ](#) [1812CS-223XJ](#) [1812LS-104XJ](#) [1812LS-105XJ](#) [1812LS-124XJ](#) [1812LS-154XJ](#) [1812LS-223XJ](#)  
[1812LS-224XJ](#) [1812LS-563XJ](#) [1812LS-683XJ](#) [1812LS-824XJ](#) [NIN-FB101JTR110F](#) [NIN-FB471JTR62F](#) [NIN-FC1R5JTR220F](#) [NIN-](#)  
[HCR15JTRF](#) [NIN-HCR33JTRF](#) [NIN-HDR22JTRF](#) [NIN-HDR82JTRF](#) [NIN-HK2N7STRF](#) [NIN-PA150KTR370F](#) [NIN-PB100KTR550F](#)