

SMD Power Inductor CD43

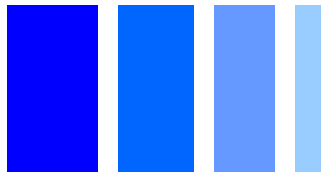

Description

- Ferrite drum core construction.
- Magnetically unshielded.
- L × W × H: 4.8 × 4.3 × 3.5mm Max.
- Product weight :165mg(Ref.)
- Moisture Sensitivity Level: 1
- RoHS compliance.

Dimension - [mm]

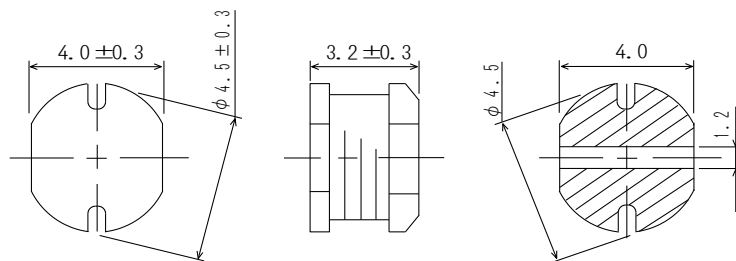

Land pattern and Schematics - [mm]

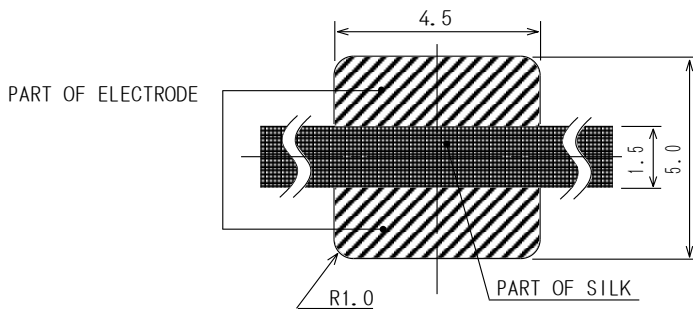

Environmental Data

- Operating temperature range: -40°C ~ +100°C (including coil's self temperature rise)
- Storage temperature range: -40°C ~ +100°C
- Solder reflow temperature: 260 °C peak.

Packaging

- Carrier tape and reel packaging.
- 12.9" diameter reel
- 1500pcs per reel

Applications

- Ideally used in Mobilephone, PDA, MP3, DSC/DVC, portable DVD etc as DC-DC Converter inductors.

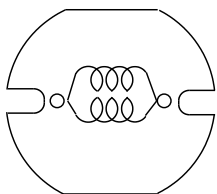

(1.0μH ~ 8.2μH)

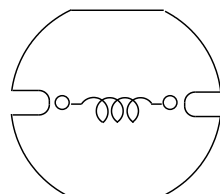

(10μH ~ 68μH)



Electrical Characteristics

Part Name	Stamp	Inductance (μH) [Within]※1	D.C.R. (m Ω) [Max.] (20 $^{\circ}\text{C}$)	Rated Current (A) ※2
CD43NP-1R0MC	1R0	1.0 \pm 20%	48.7	2.70
CD43NP-1R4MC	1R4	1.4 \pm 20%	56.2	2.50
CD43NP-1R8MC	1R8	1.8 \pm 20%	63.7	2.33
CD43NP-2R2MC	2R2	2.2 \pm 20%	71.2	2.25
CD43NP-2R7MC	2R7	2.7 \pm 20%	78.7	2.16
CD43NP-3R3MC	3R3	3.3 \pm 20%	86.2	2.00
CD43NP-3R9MC	3R9	3.9 \pm 20%	93.7	1.84
CD43NP-4R7MC	4R7	4.7 \pm 20%	108.7	1.62
CD43NP-5R6MC	5R6	5.6 \pm 20%	125.7	1.48
CD43NP-6R8MC	6R8	6.8 \pm 20%	131.2	1.43
CD43NP-8R2MC	8R2	8.2 \pm 20%	146.2	1.37
CD43NP-100MC	100	10 \pm 20%	182	1.04
CD43NP-120MC	120	12 \pm 20%	210	0.97
CD43NP-150MC	150	15 \pm 20%	235	0.85
CD43NP-180MC	180	18 \pm 20%	338	0.74
CD43NP-220MC	220	22 \pm 20%	378	0.68
CD43NP-270MC	270	27 \pm 20%	522	0.62
CD43NP-330KC	330	33 \pm 10%	540	0.56
CD43NP-390KC	390	39 \pm 10%	587	0.52
CD43NP-470KC	470	47 \pm 10%	844	0.44
CD43NP-560KC	560	56 \pm 10%	937	0.42
CD43NP-680KC	680	68 \pm 10%	1117	0.37

※1: Inductance measuring frequency: 1.0 μH ~ 8.2 μH ; at 7.96 MHz.
10 μH ~ 68 μH ; at 2.52 MHz.

※2: Rated current: The DC current at which the inductance decreases to 90 % of it's initial value or when $\Delta t=40^{\circ}\text{C}$, whichever is lower ($T_a=20^{\circ}\text{C}$).

SMD Power Inductor CD43



Saturation Current & Temperature Rise Graph

— L (20°C) — L (105°C) — ΔT

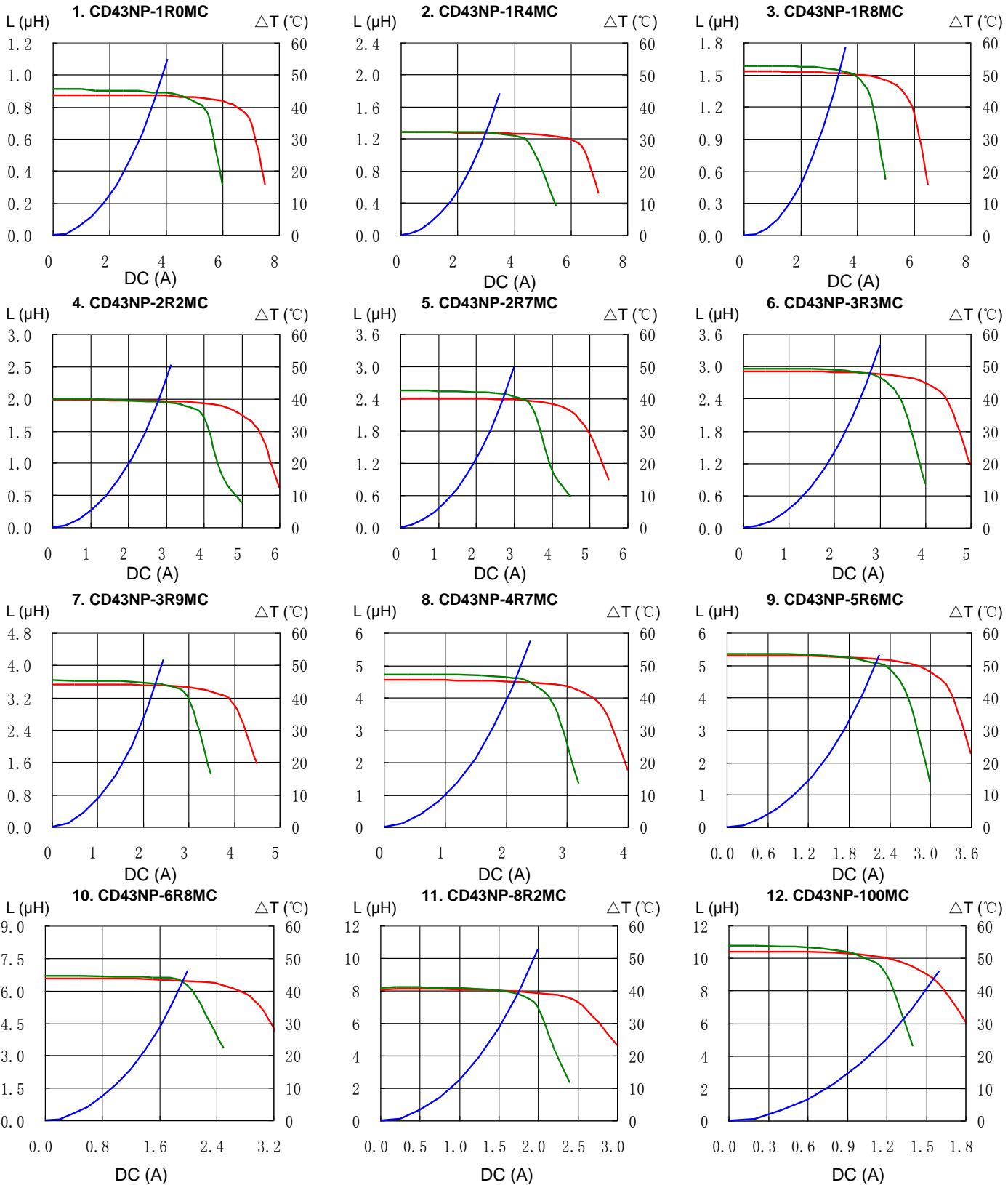

SMD Power Inductor CD43



Saturation Current & Temperature Rise Graph

— L (20°C) — L (105°C) — ΔT

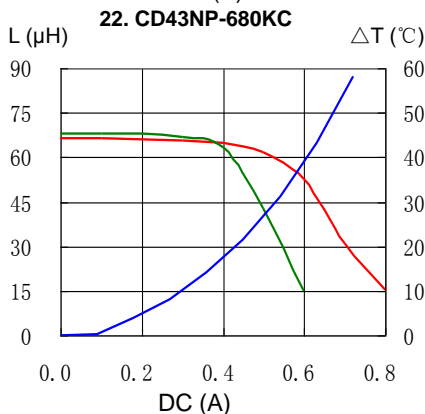
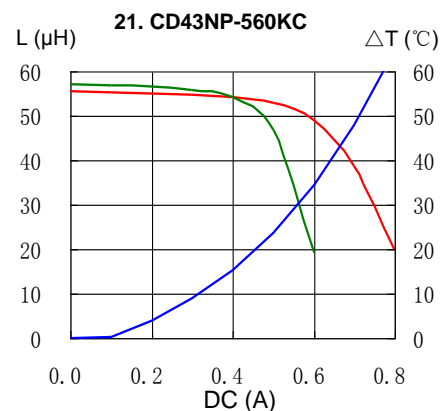
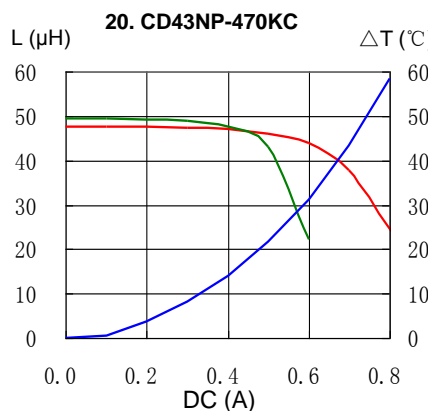
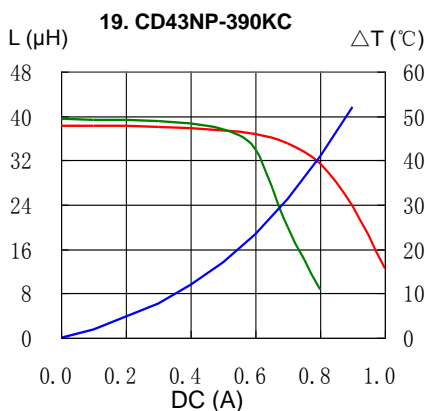
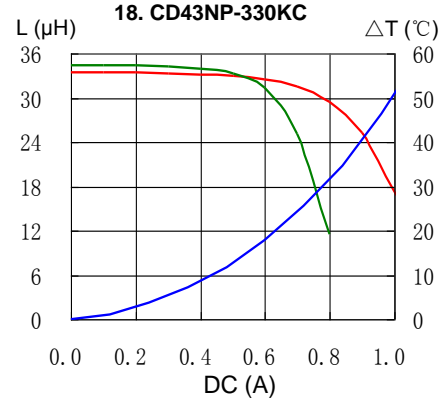
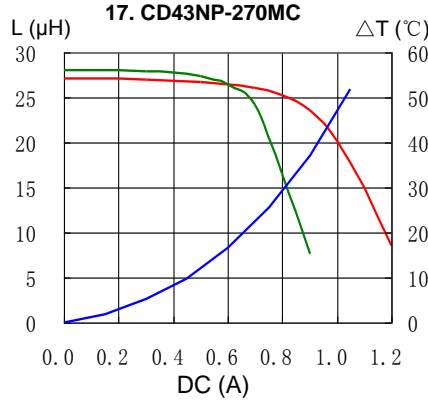
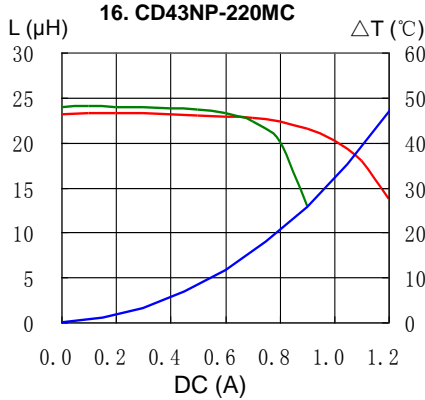
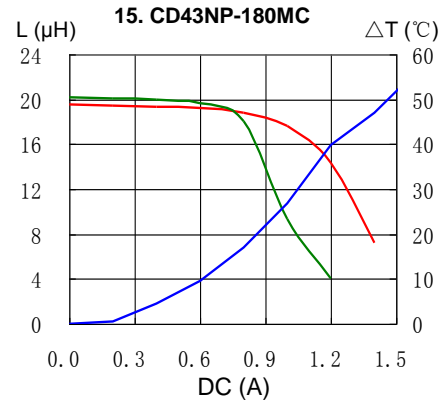
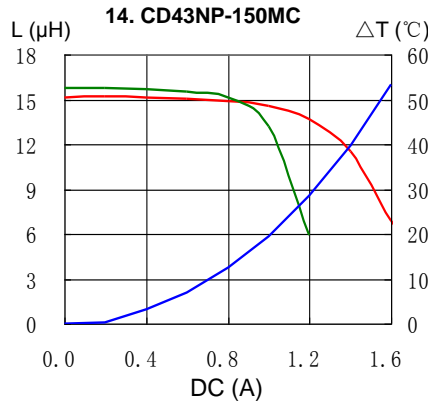
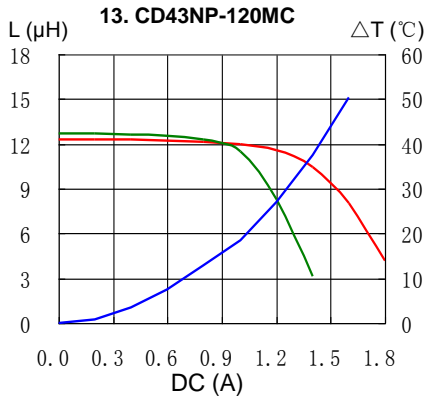

SMD Power Inductor CD43

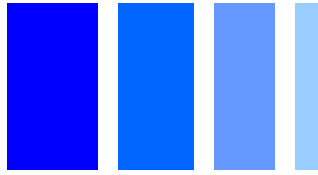

Solder Reflow Condition

Heat Endurance

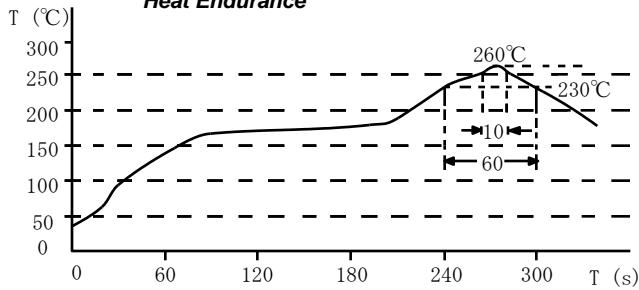

Temperature Chart

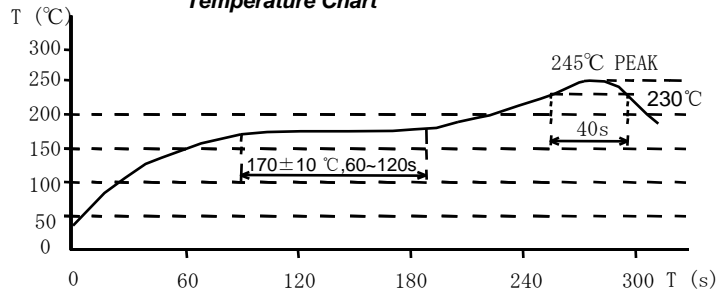

Please refer to the sales offices on our website - <http://www.sumida.com>

Hong Kong

Tel.+852-2880-6781
FAX.+852-2565-9600
sales@hk.sumida.com

Saitama(Japan)

Tel.+81-48-691-7300
FAX.+81-48-691-7340
sales@jp.sumida.com

Chicago

Tel.+1-847-545-6700
FAX. +1-847-545-6720
sales@us.sumida.com

Shanghai

Tel.+86-21-5836-3299
FAX.+86-21-5836-3266
shanghai.sales@cn.sumida.com

Seoul

Tel.+82-2-6237-0777
FAX.+82-2-6237-0778
sales@kr.sumida.com

Obernzell

Tel.+49-8591-937-0
FAX. +49-8591-937-103
contact@eu.sumida.com

Shenzhen

Tel.+86-755-8291-0228
FAX.+86-755-8291-0338
shenzhen.sales@cn.sumida.com

Singapore

Tel.+65-6296-3388
FAX.+65-6841-4426
sales@sg.sumida.com

Neumarkt

Tel.+49-9181-4509-110
FAX. +49-9181-4509-310
infocomp@eu.sumida.com

Taipei

Tel.+886-2-8751-2737
FAX.+886-2-8751-2738
sales@tw.sumida.com

San Jose

Tel.+1-408-321-9660
FAX.+1-408-321-9308
sales@us.sumida.com

X-ON Electronics

Largest Supplier of Electrical and Electronic Components

Click to view similar products for [Fixed Inductors](#) category:

Click to view products by [Sumida](#) manufacturer:

Other Similar products are found below :

[CR43NP-680KC](#) [CR54NP-820KC](#) [CR54NP-8R5MC](#) [CTX32CT-100](#) [70F224AI](#) [MGDQ4-00004-P](#) [MHL1ECTTP18NJ](#) [MHL1JCTTD12NJ](#)
[PE-51506NL](#) [PE-53601NL](#) [PE-53602NL](#) [PE-53630NL](#) [PE-53824SNLT](#) [PE-62892NL](#) [PE-92100NL](#) [PG0434.801NLT](#) [PG0936.113NLT](#)
[9310-16](#) [PM06-2N7](#) [PM06-39NJ](#) [A01TK](#) [1206CS-471XJ](#) [HC2-2R2TR](#) [HC2LP-R47-R](#) [HC3-2R2-R](#) [1206CS-151XG](#) [RCH664NP-140L](#)
[RCH664NP-4R7M](#) [RCH8011NP-221L](#) [RCP1317NP-332L](#) [RCP1317NP-391L](#) [RCR1010NP-470M](#) [RCR110DNP-331L](#) [DH2280-4R7M](#)
[DS1608C-106](#) [ASPI-4020HI-R10M-T](#) [B10TJ](#) [B82477P4333M](#) [B82498B3101J000](#) [B82498B3680J000](#) [ELJ-RE27NJF2](#) [1812CS-153XJ](#)
[1812CS-183XJ](#) [1812CS-223XJ](#) [1812LS-104XJ](#) [1812LS-105XJ](#) [1812LS-124XJ](#) [1812LS-154XJ](#) [1812LS-223XJ](#) [1812LS-224XJ](#)