

SMD Power Inductor CDH115



Halogen Free



Description

- Ferrite drum core construction.
- Magnetically unshielded.
- L × W × H: 11.2 × 11.2 × 5.2 mm Max.
- Product weight: 1.6g(Ref.)
- Moisture Sensitivity Level: 1
- RoHS compliance.
- Halogen Free available.

Environmental Data

- Operating temperature range: -40°C~+100°C (including coil's self temperature rise)
- Storage temperature range: -40°C~+100°C
- Solder reflow temperature: 260 °C peak.

Packaging

- Carrier tape and reel packaging.
- 12.9" diameter reel
- 500pcs per reel

Applications

- Ideally used in Notebook PC ,DVD, LCD TV ,Game machine, Projector etc as DC-DC converter inductors.

Dimension - [mm]

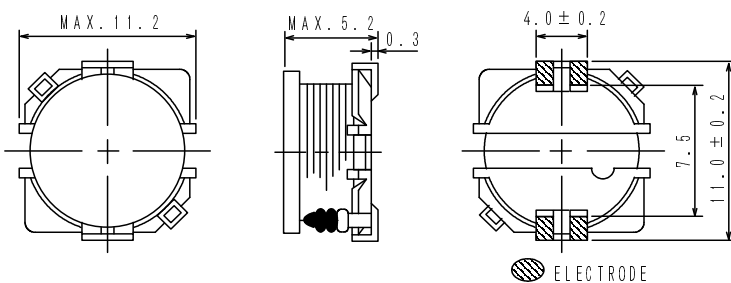

Land pattern and Schematics - [mm]

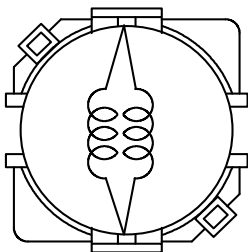
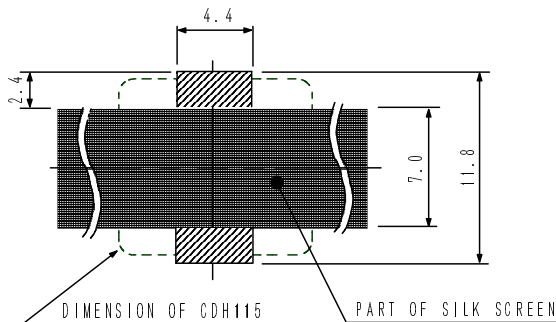

10 μ H ~ 33 μ H

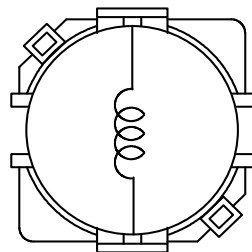

39 μ H ~ 470 μ H

SMD Power Inductor CDH115



Electrical Characteristics

Part Name	Stamp	Inductance (μ H) [within] ※1	D.C.R.(Ω) Max. (Typ.) (at 20°C)	Rated Current (A) ※2
CDH115NP-100MC	100	10 \pm 20%	28m(22m)	3.00
CDH115NP-120MC	120	12 \pm 20%	33m(25m)	2.80
CDH115NP-150MC	150	15 \pm 20%	39m(30m)	2.50
CDH115NP-180LC	180	18 \pm 15%	49m(38m)	2.25
CDH115NP-220LC	220	22 \pm 15%	60m(46m)	2.10
CDH115NP-270LC	270	27 \pm 15%	70m(54m)	1.84
CDH115NP-330LC	330	33 \pm 15%	82m(63m)	1.68
CDH115NP-390KC	390	39 \pm 10%	0.11(85m)	1.52
CDH115NP-470KC	470	47 \pm 10%	0.13(0.10)	1.36
CDH115NP-560KC	560	56 \pm 10%	0.14(0.11)	1.28
CDH115NP-680KC	680	68 \pm 10%	0.16(0.12)	1.20
CDH115NP-820KC	820	82 \pm 10%	0.21(0.16)	1.04
CDH115NP-101KC	101	100 \pm 10%	0.26(0.20)	0.96
CDH115NP-121KC	121	120 \pm 10%	0.29(0.22)	0.88
CDH115NP-151KC	151	150 \pm 10%	0.40(0.31)	0.76
CDH115NP-181KC	181	180 \pm 10%	0.45(0.35)	0.72
CDH115NP-221KC	221	220 \pm 10%	0.53(0.40)	0.66
CDH115NP-271KC	271	270 \pm 10%	0.73(0.56)	0.59
CDH115NP-331KC	331	330 \pm 10%	0.84(0.65)	0.53
CDH115NP-391KC	391	390 \pm 10%	1.10(0.84)	0.48
CDH115NP-471KC	471	470 \pm 10%	1.24(0.96)	0.45

※1. Inductance measuring condition: at 1kHz.

※2. Rated current: The DC current at which the inductance decreases to 90 % of it's initial value or when $\Delta t=40^{\circ}\text{C}$, whichever is lower ($T_a=20^{\circ}\text{C}$)

SMD Power Inductor CDH115



Saturation Current & Temperature Rise Graph

— L (20°C) — L (100°C) — ΔT

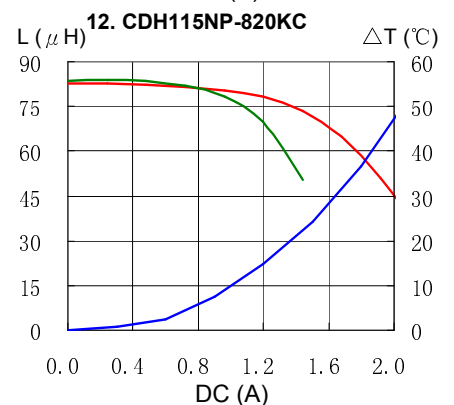
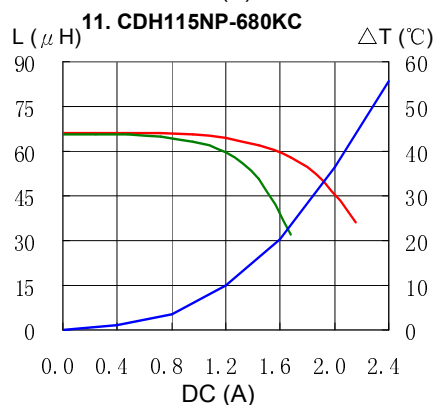
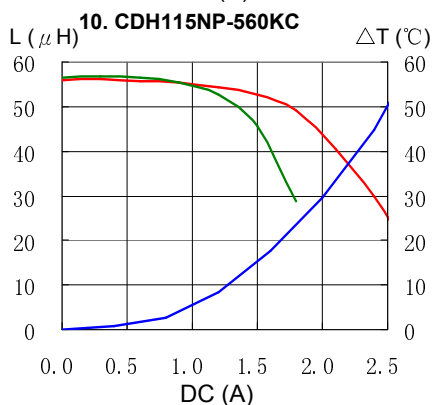
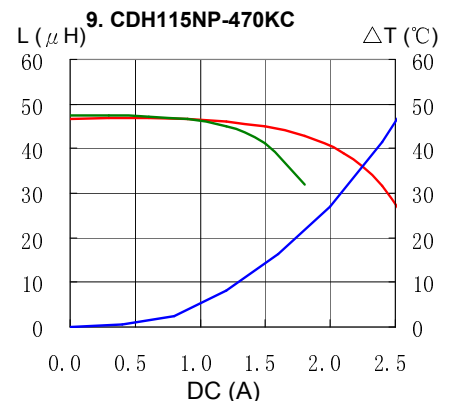
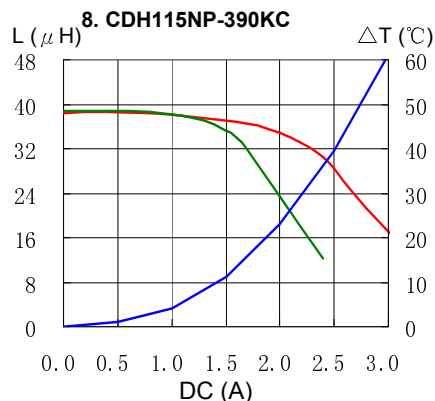
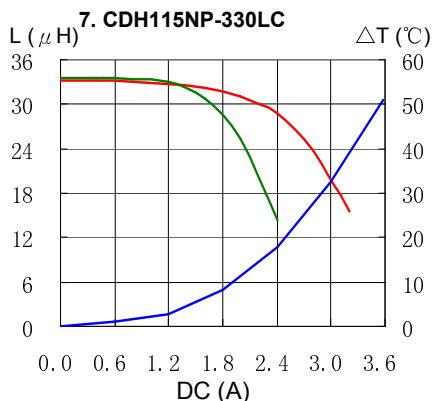
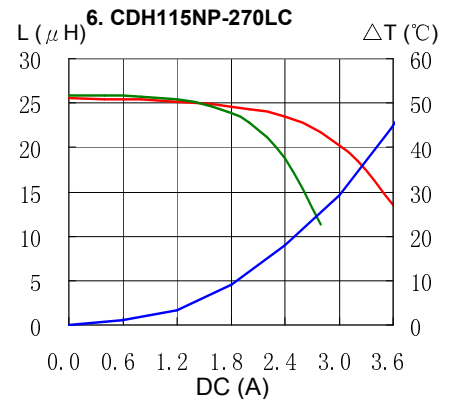
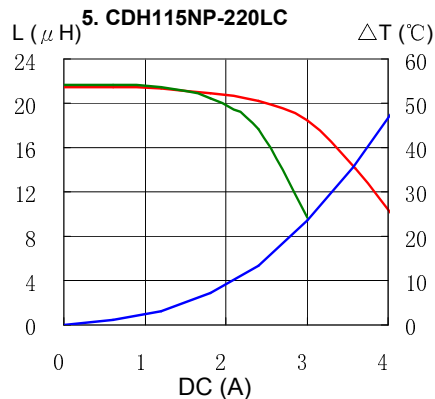
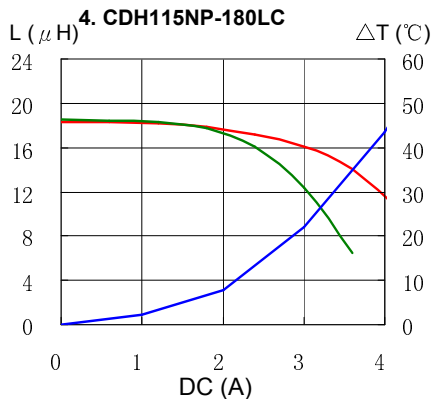
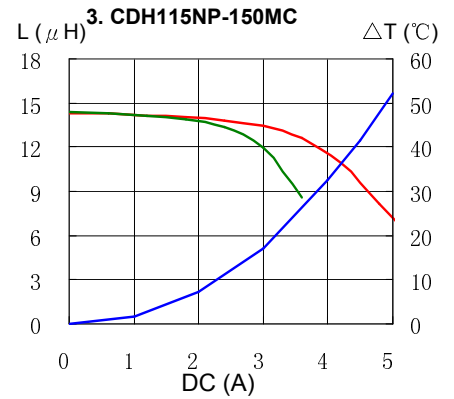
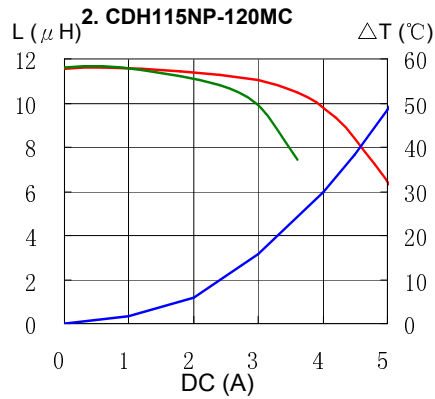
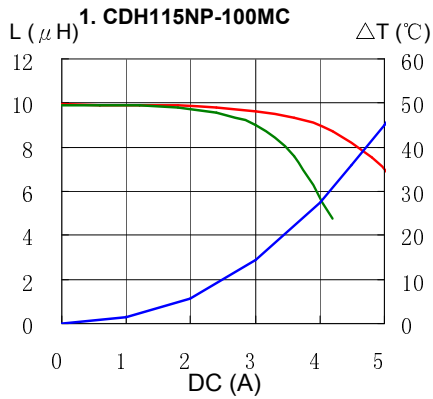

SMD Power Inductor CDH115



Saturation Current & Temperature Rise Graph

— L (20°C) — L (100°C) — ΔT

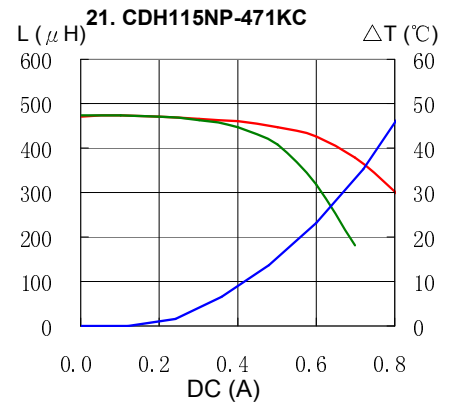
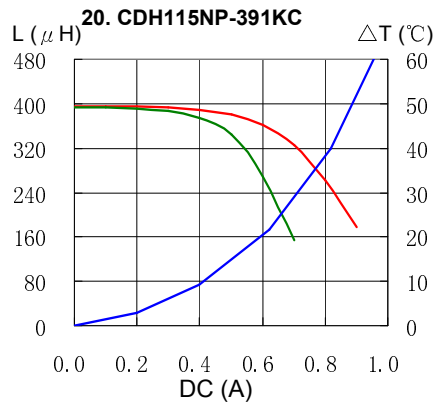
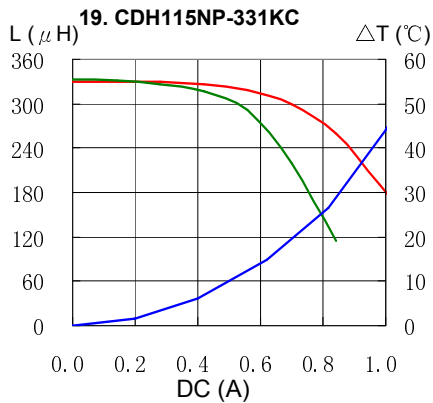
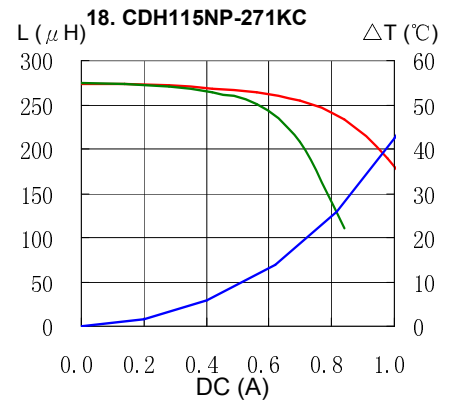
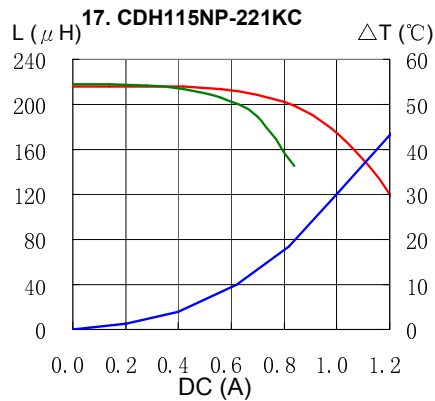
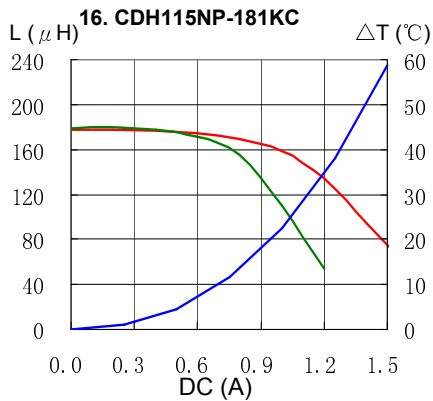
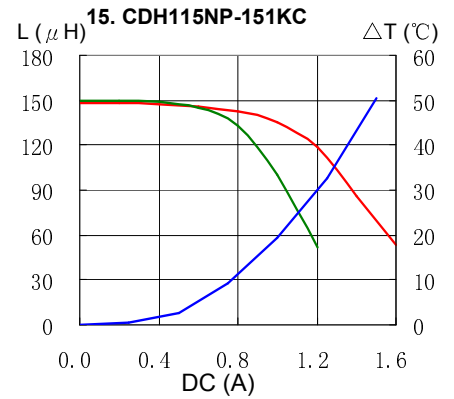
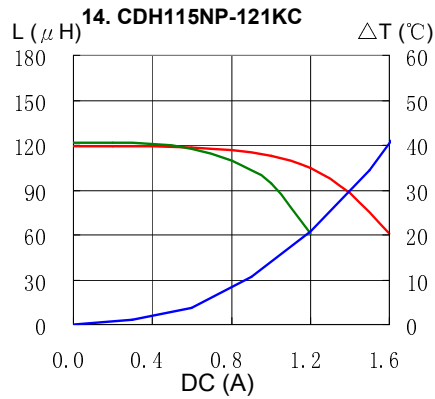
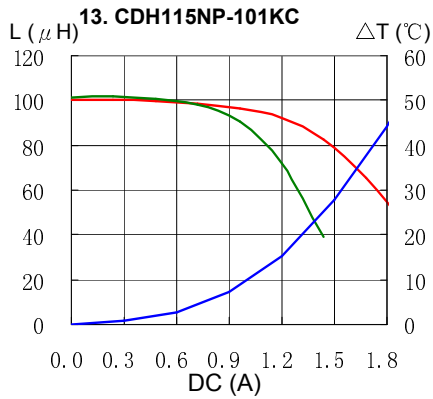

SMD Power Inductor CDH115



Solder Reflow Condition

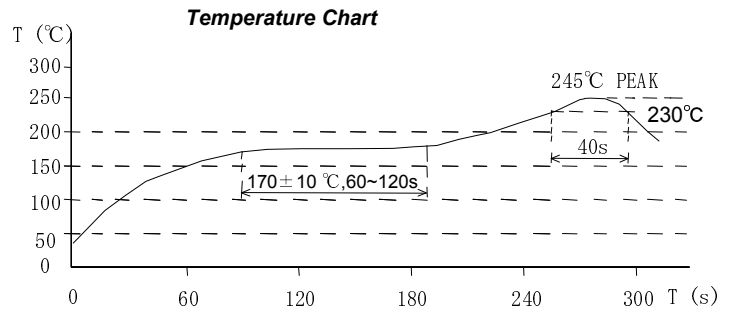
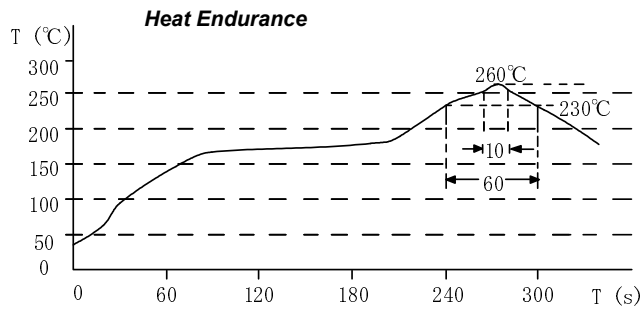

Please refer to the sales offices on our website - <http://www.sumida.com>

Hong Kong

Tel.+852-2880-6781
FAX.+852-2565-9600
sales@hk.sumida.com

Saitama(Japan)

Tel.+81-48-691-7300
FAX.+81-48-691-7340
sales@jp.sumida.com

Chicago

Tel.+1-847-545-6700
FAX. +1-847-545-6720
sales@us.sumida.com

Shanghai

Tel.+86-21-5836-3299
FAX.+86-21-5836-3266
shanghai.sales@cn.sumida.com

Seoul

Tel.+82-2-6237-0777
FAX.+82-2-6237-0778
sales@kr.sumida.com

Oberzell

Tel.+49-8591-937-0
FAX. +49-8591-937-103
contact@eu.sumida.com

Shenzhen

Tel.+86-755-8291-0228
FAX.+86-755-8291-0338
shenzhen.sales@cn.sumida.com

Singapore

Tel.+65-6296-3388
FAX.+65-6841-4426
sales@sg.sumida.com

Neumarkt

Tel.+49-9181-4509-110
FAX. +49-9181-4509-310
infocomp@eu.sumida.com

Taipei

Tel.+886-2-8751-2737
FAX.+886-2-8751-2738
sales@tw.sumida.com

San Jose

Tel.+1-408-321-9660
FAX.+1-408-321-9308
sales@us.sumida.com

X-ON Electronics

Largest Supplier of Electrical and Electronic Components

Click to view similar products for [Fixed Inductors](#) category:

Click to view products by [Sumida](#) manufacturer:

Other Similar products are found below :

[CR43NP-680KC](#) [CR54NP-820KC](#) [CR54NP-8R5MC](#) [CTX32CT-100](#) [70F224AI](#) [MGDQ4-00004-P](#) [MHL1ECTTP18NJ](#) [MHL1JCTTD12NJ](#)
[PE-51506NL](#) [PE-53601NL](#) [PE-53602NL](#) [PE-53630NL](#) [PE-53824SNLT](#) [PE-62892NL](#) [PE-92100NL](#) [PG0434.801NLT](#) [PG0936.113NLT](#)
[9310-16](#) [PM06-2N7](#) [PM06-39NJ](#) [A01TK](#) [1206CS-471XJ](#) [HC2-2R2TR](#) [HC2LP-R47-R](#) [HC3-2R2-R](#) [1206CS-151XG](#) [RCH664NP-140L](#)
[RCH664NP-4R7M](#) [RCH8011NP-221L](#) [RCP1317NP-332L](#) [RCP1317NP-391L](#) [RCR1010NP-470M](#) [RCR110DNP-331L](#) [DH2280-4R7M](#)
[DS1608C-106](#) [ASPI-4020HI-R10M-T](#) [B10TJ](#) [B82477P4333M](#) [B82498B3101J000](#) [B82498B3680J000](#) [ELJ-RE27NJF2](#) [1812CS-153XJ](#)
[1812CS-183XJ](#) [1812CS-223XJ](#) [1812LS-104XJ](#) [1812LS-105XJ](#) [1812LS-124XJ](#) [1812LS-154XJ](#) [1812LS-223XJ](#) [1812LS-224XJ](#)