

# SMD Power Inductor CDR6D23MN



## Description

- Ferrite drum core construction.
- Magnetically shielded.
- L × W × H: 6.8 × 6.8 × 2.5 mm Max.
- Product weight: 0.27g(Ref.)
- Moisture Sensitivity Level: 1
- RoHS compliance.

## Environmental Data

- Operating temperature range: -40°C ~ +105°C (including coil's self temperature rise)
- Storage temperature range: -40°C ~ +105°C
- Solder reflow temperature: 260 °C peak.

## Packaging

- Carrier tape and reel packaging
- 11.8" diameter reel
- 1500pcs per reel

## Applications

- Ideally used in LCD driver, DSC/DVC , Notebook PC or the other portable equipment

## Dimension - [mm]

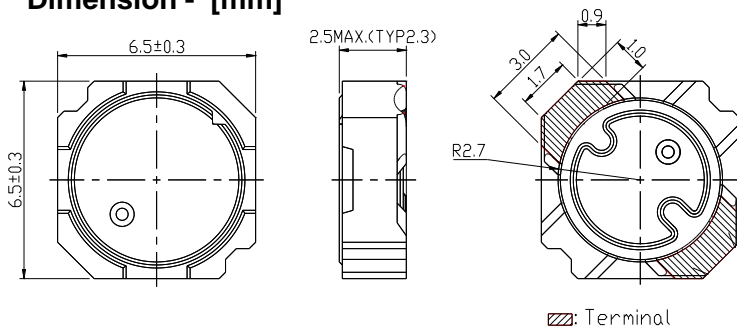

## Land pattern and Schematics - [mm]

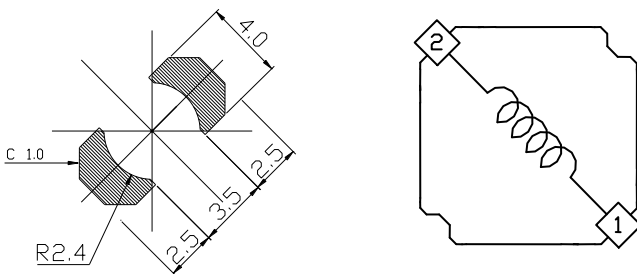



### Electrical Characteristics

Part Name	Stamp	Inductance ( $\mu\text{H}$ ) [Within] ※1	D.C.R. (m $\Omega$ ) Max. (Typ.) (at 20°C)	Saturation Current (A) ※2		Temperature Rise Current (A)※3
				(at 20°C)	(at 105°C)	
CDR6D23MNNP-0R6NC	0R6	0.6 $\mu\text{H} \pm 25\%$	20.0(16)	6.55	4.95	4.60
CDR6D23MNNP-1R0NC	1R0	1.0 $\mu\text{H} \pm 25\%$	25.0(20)	5.15	4.00	3.90
CDR6D23MNNP-1R5NC	1R5	1.5 $\mu\text{H} \pm 25\%$	28.0(22)	4.40	3.55	3.30
CDR6D23MNNP-2R0NC	2R0	2.0 $\mu\text{H} \pm 25\%$	36.3(29)	3.85	3.05	2.60
CDR6D23MNNP-2R7NC	2R7	2.7 $\mu\text{H} \pm 25\%$	40.0(32)	3.30	2.60	2.38
CDR6D23MNNP-3R3NC	3R3	3.3 $\mu\text{H} \pm 25\%$	46.3(37)	2.95	2.30	2.25
CDR6D23MNNP-4R2NC	4R2	4.2 $\mu\text{H} \pm 25\%$	52.5(42)	2.60	2.10	2.05
CDR6D23MNNP-5R1NC	5R1	5.1 $\mu\text{H} \pm 25\%$	60.0(48)	2.45	1.95	1.90
CDR6D23MNNP-6R1NC	6R1	6.1 $\mu\text{H} \pm 25\%$	66.3(53)	2.30	1.75	1.80
CDR6D23MNNP-7R2NC	7R2	7.2 $\mu\text{H} \pm 25\%$	72.5(58)	2.10	1.60	1.70
CDR6D23MNNP-8R3NC	8R3	8.3 $\mu\text{H} \pm 25\%$	80.0(64)	1.95	1.50	1.50
CDR6D23MNNP-100NC	100	10 $\mu\text{H} \pm 25\%$	103.8(83)	1.75	1.40	1.30
CDR6D23MNNP-120NC	120	12 $\mu\text{H} \pm 25\%$	117.5(94)	1.55	1.25	1.25
CDR6D23MNNP-150NC	150	15 $\mu\text{H} \pm 25\%$	133.8(107)	1.40	1.15	1.10
CDR6D23MNNP-180NC	180	18 $\mu\text{H} \pm 25\%$	158.8(127)	1.30	1.05	1.00
CDR6D23MNNP-220NC	220	22 $\mu\text{H} \pm 25\%$	187.5(150)	1.20	0.95	0.80
CDR6D23MNNP-270NC	270	27 $\mu\text{H} \pm 25\%$	255.0(204)	1.05	0.85	0.75
CDR6D23MNNP-330NC	330	33 $\mu\text{H} \pm 25\%$	275.0(220)	0.95	0.75	0.70
CDR6D23MNNP-390NC	390	39 $\mu\text{H} \pm 25\%$	393.8(315)	0.90	0.70	0.58
CDR6D23MNNP-470NC	470	47 $\mu\text{H} \pm 25\%$	456.3(365)	0.80	0.60	0.54
CDR6D23MNNP-560NC	560	56 $\mu\text{H} \pm 25\%$	481.2(385)	0.75	0.58	0.51
CDR6D23MNNP-680NC	680	68 $\mu\text{H} \pm 25\%$	751.3(601)	0.65	0.53	0.45
CDR6D23MNNP-820NC	820	82 $\mu\text{H} \pm 25\%$	803.8(643)	0.60	0.47	0.43
CDR6D23MNNP-101NC	101	100 $\mu\text{H} \pm 25\%$	903.8(723)	0.55	0.44	0.41

※1. Inductance measuring condition: at 100kHz.

※2. Saturation current: The value of D.C. current when the inductance decreases to 65% of it's nominal value.

※3. Temperature rise current: The value of D.C. current when the temperature rise is  $\Delta t = 40^\circ\text{C}$  ( $T_a = 20^\circ\text{C}$ ).

# SMD Power Inductor CDR6D23MN



## Saturation Current & Temperature Rise Graph

— L (20°C) — L (105°C) —  $\Delta T$

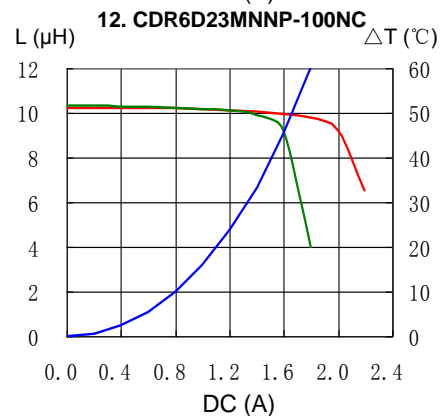
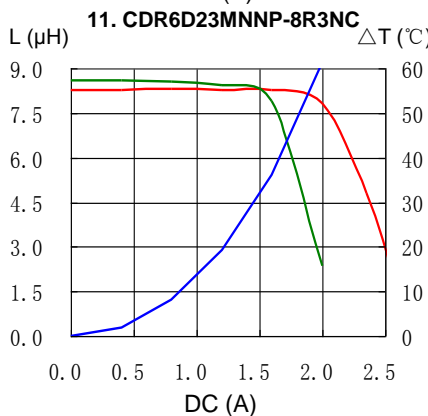
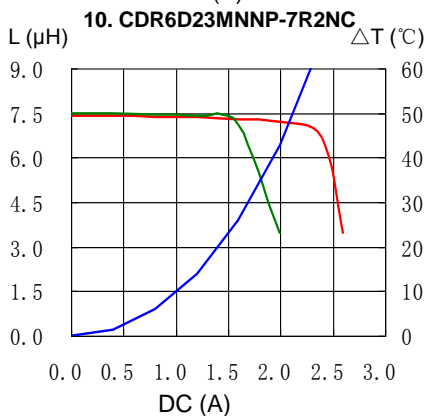
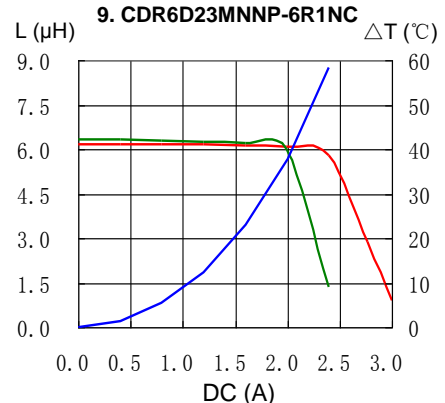
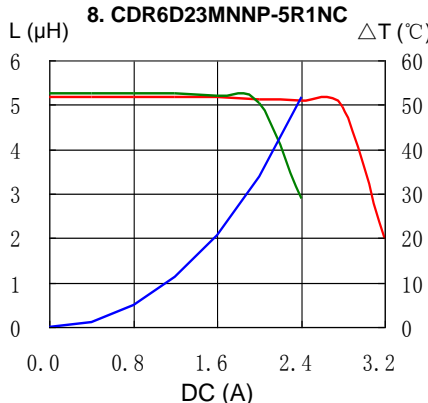
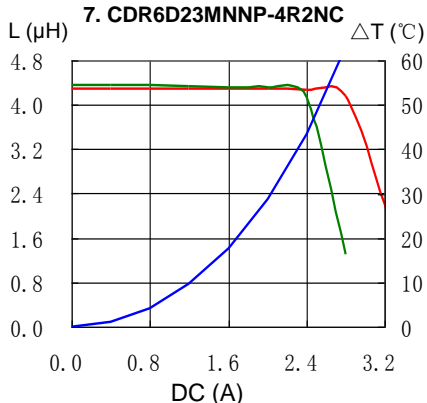
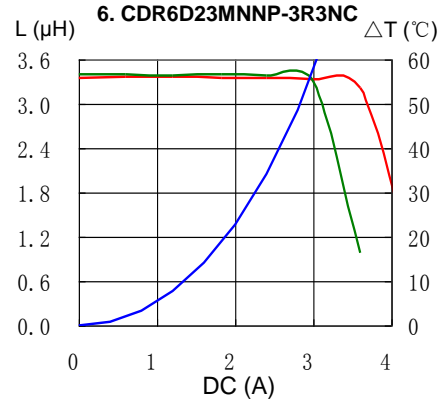
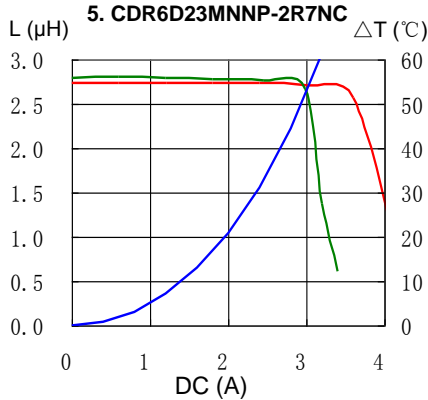
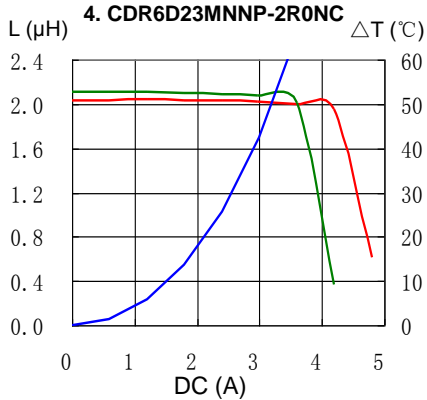
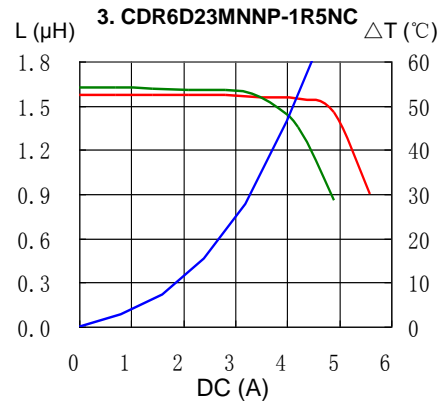
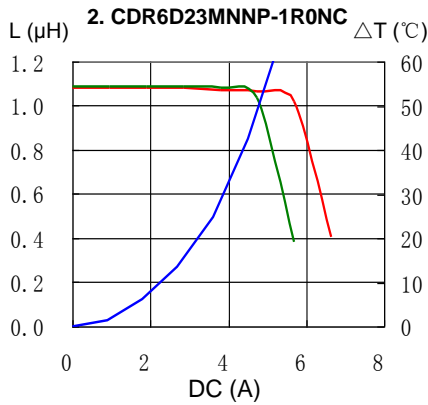
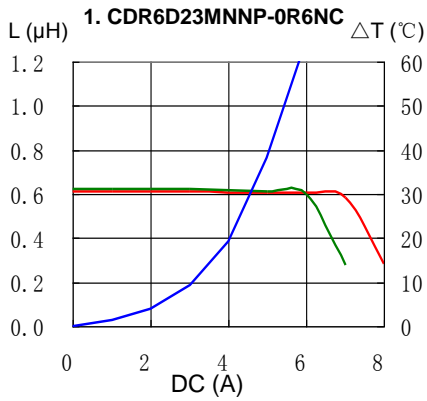

# SMD Power Inductor CDR6D23MN



## Saturation Current & Temperature Rise Graph

— L (20°C) — L (105°C) —  $\Delta T$

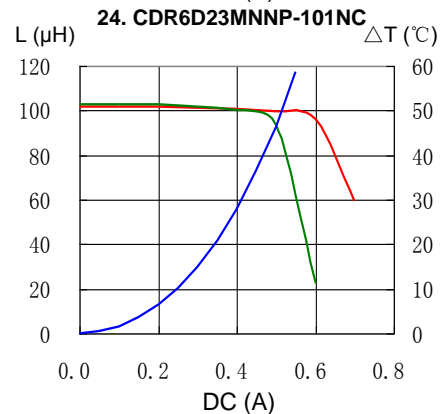
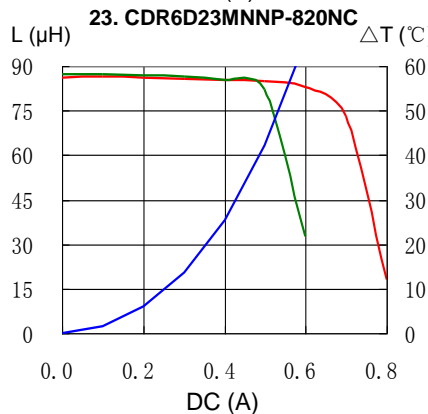
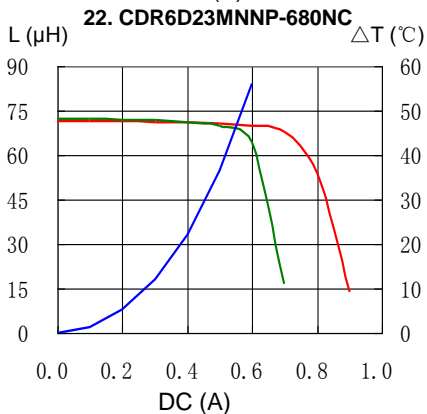
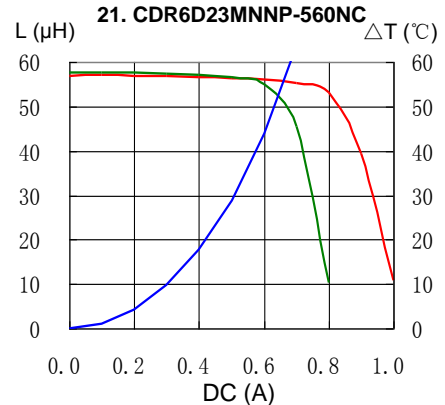
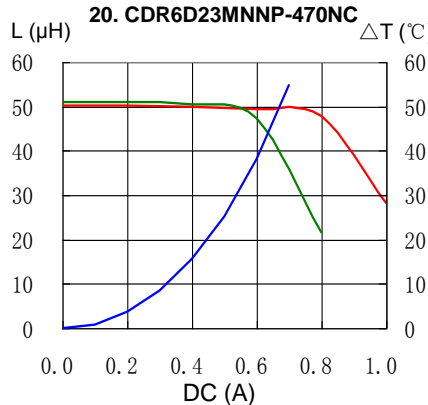
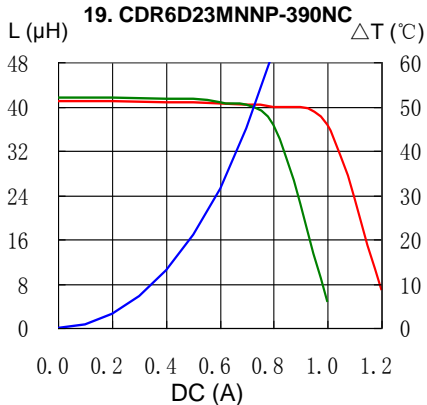
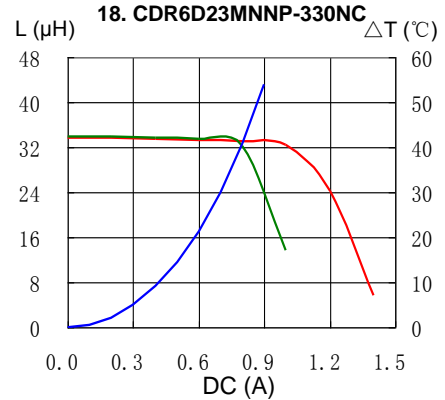
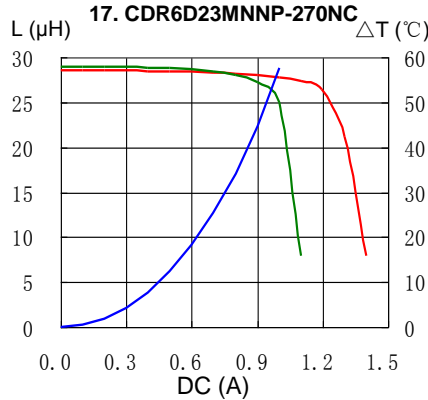
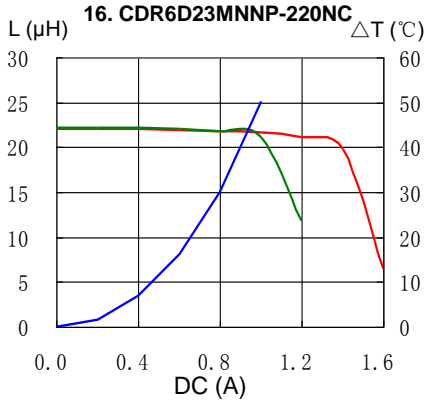
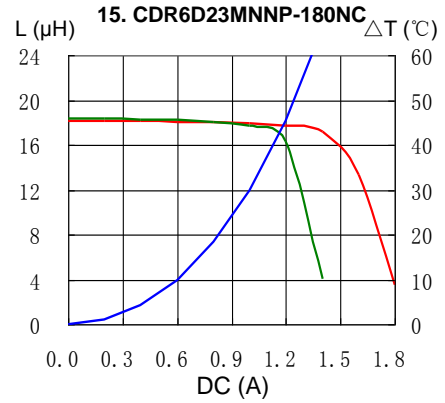
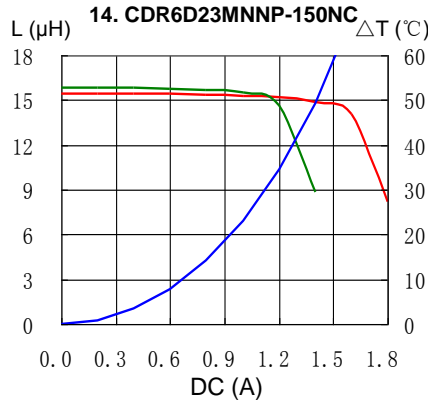
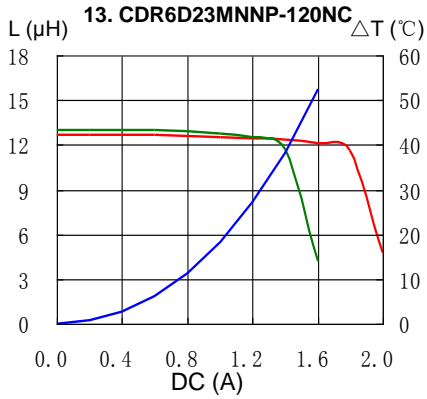

# SMD Power Inductor CDR6D23MN



## Solder Reflow Condition

**Heat Endurance**

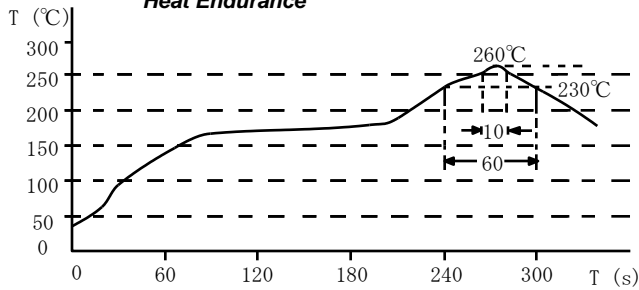

**Temperature Chart**

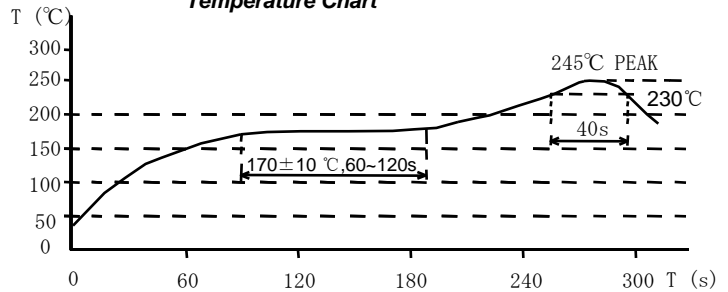

Please refer to the sales offices on our website - <http://www.sumida.com>

### Hong Kong

Tel.+852-2880-6781  
FAX.+852-2565-9600  
[sales@hk.sumida.com](mailto:sales@hk.sumida.com)

### Saitama(Japan)

Tel.+81-48-691-7300  
FAX.+81-48-691-7340  
[sales@jp.sumida.com](mailto:sales@jp.sumida.com)

### Chicago

Tel.+1-847-545-6700  
FAX. +1-847-545-6720  
[sales@us.sumida.com](mailto:sales@us.sumida.com)

### Shanghai

Tel.+86-21-5836-3299  
FAX.+86-21-5836-3266  
[shanghai.sales@cn.sumida.com](mailto:shanghai.sales@cn.sumida.com)

### Seoul

Tel.+82-2-6237-0777  
FAX.+82-2-6237-0778  
[sales@kr.sumida.com](mailto:sales@kr.sumida.com)

### Obernzell

Tel.+49-8591-937-0  
FAX. +49-8591-937-103  
[contact@eu.sumida.com](mailto:contact@eu.sumida.com)

### Shenzhen

Tel.+86-755-8291-0228  
FAX.+86-755-8291-0338  
[shenzhen.sales@cn.sumida.com](mailto:shenzhen.sales@cn.sumida.com)

### Singapore

Tel.+65-6296-3388  
FAX.+65-6841-4426  
[sales@sg.sumida.com](mailto:sales@sg.sumida.com)

### Neumarkt

Tel.+49-9181-4509-110  
FAX. +49-9181-4509-310  
[infocomp@eu.sumida.com](mailto:infocomp@eu.sumida.com)

### Taipei

Tel.+886-2-8751-2737  
FAX.+886-2-8751-2738  
[sales@tw.sumida.com](mailto:sales@tw.sumida.com)

### San Jose

Tel.+1-408-321-9660  
FAX.+1-408-321-9308  
[sales@us.sumida.com](mailto:sales@us.sumida.com)

## X-ON Electronics

Largest Supplier of Electrical and Electronic Components

*Click to view similar products for [Fixed Inductors](#) category:*

*Click to view products by [Sumida](#) manufacturer:*

Other Similar products are found below :

[CR43NP-680KC](#) [CR54NP-820KC](#) [CR54NP-8R5MC](#) [CTX32CT-100](#) [70F224AI](#) [MGDQ4-00004-P](#) [MHL1ECTTP18NJ](#) [MHL1JCTTD12NJ](#)  
[PE-51506NL](#) [PE-53601NL](#) [PE-53602NL](#) [PE-53630NL](#) [PE-53824SNLT](#) [PE-62892NL](#) [PE-92100NL](#) [PG0434.801NLT](#) [PG0936.113NLT](#)  
[9310-16](#) [PM06-2N7](#) [PM06-39NJ](#) [A01TK](#) [1206CS-471XJ](#) [HC2-2R2TR](#) [HC2LP-R47-R](#) [HC3-2R2-R](#) [1206CS-151XG](#) [RCH664NP-140L](#)  
[RCH664NP-4R7M](#) [RCH8011NP-221L](#) [RCP1317NP-332L](#) [RCP1317NP-391L](#) [RCR1010NP-470M](#) [RCR110DNP-331L](#) [DH2280-4R7M](#)  
[DS1608C-106](#) [ASPI-4020HI-R10M-T](#) [B10TJ](#) [B82477P4333M](#) [B82498B3101J000](#) [B82498B3680J000](#) [ELJ-RE27NJF2](#) [1812CS-153XJ](#)  
[1812CS-183XJ](#) [1812CS-223XJ](#) [1812LS-104XJ](#) [1812LS-105XJ](#) [1812LS-124XJ](#) [1812LS-154XJ](#) [1812LS-223XJ](#) [1812LS-224XJ](#)