

# SMD Power Inductor CDRH104R/T125

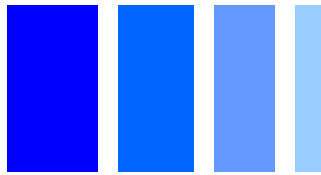

## Description

- Ferrite drum core construction.
- Magnetically shielded.
- L × W × H: 10.5 × 10.3 × 4.0 mm Max.
- Product weight: 1.5g(Ref.)
- Moisture Sensitivity Level: 1
- RoHS compliance.
- Qualified to AEC-Q200.

## Dimension - [mm]

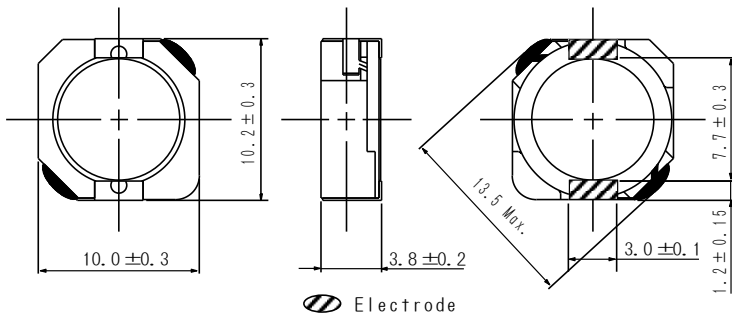

## Environmental Data

- Operating temperature range: -40°C ~ +125°C (including coil's self temperature rise)
- Storage temperature range: -40°C ~ +125°C
- Solder reflow temperature: 260 °C peak.

## Packaging

- Carrier tape and reel packaging
- 13" diameter reel
- 1000pcs per reel

## Applications

- Automotive.

## Land pattern and Schematics - [mm]

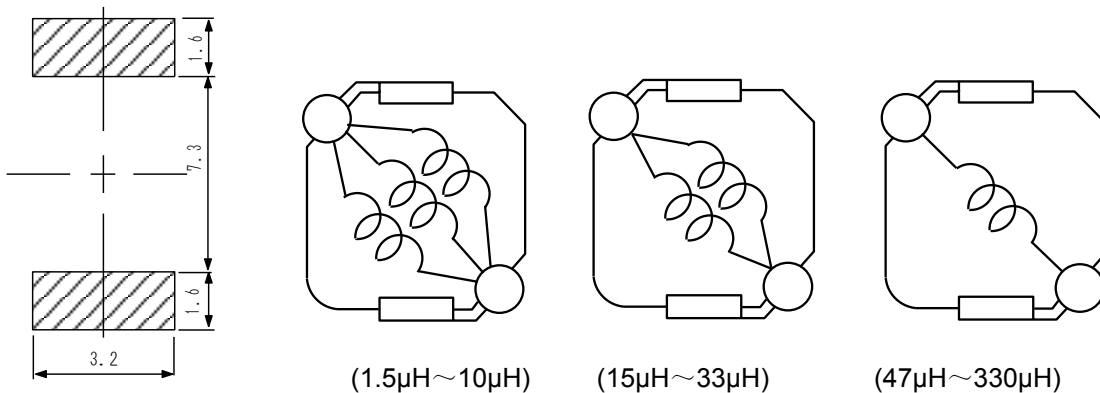



### Electrical Characteristics

Part No.	Stamp	Inductance ( $\mu\text{H}$ ) [Within] ※1	D.C.R. ( $\Omega$ ) [Max.] (at 20°C) ※2	Rated current (A)		
				Saturation current (A) ※3		Temperature rise current (A) ※4
				(at 20°C)	(at 125°C) (Typ.)	
CDRH104RT125NP-1R4PC	1R4	1.4 $\pm$ 25%	9.0m(7.2m)	9.20	7.36	7.80
CDRH104RT125NP-2R2PC	2R2	2.2 $\pm$ 25%	11.0m(8.8m)	8.00	6.16	7.10
CDRH104RT125NP-3R6PC	3R6	3.6 $\pm$ 25%	14.0m(11.2m)	6.07	5.00	6.20
CDRH104RT125NP-4R7PC	4R7	4.7 $\pm$ 25%	19.1m(15.3m)	5.57	4.60	5.20
CDRH104RT125NP-6R8PC	6R8	6.8 $\pm$ 25%	25.6m(20.5m)	4.66	3.94	4.40
CDRH104RT125NP-100MC	100	10 $\pm$ 20%	36.8m(29.5m)	4.10	3.46	3.50
CDRH104RT125NP-150MC	150	15 $\pm$ 20%	48.1m(38.5m)	3.34	2.80	2.90
CDRH104RT125NP-220MC	220	22 $\pm$ 20%	70.0m(56.0m)	2.56	2.18	2.30
CDRH104RT125NP-330MC	330	33 $\pm$ 20%	93.8m(75.0m)	2.14	1.80	2.05
CDRH104RT125NP-470MC	470	47 $\pm$ 20%	136m(109m)	1.80	1.51	1.68
CDRH104RT125NP-680MC	680	68 $\pm$ 20%	216m(173m)	1.57	1.32	1.25
CDRH104RT125NP-101MC	101	100 $\pm$ 20%	300m(240m)	1.30	1.10	1.05
CDRH104RT125NP-151MC	151	150 $\pm$ 20%	448m(358m)	1.00	0.85	0.86
CDRH104RT125NP-221MC	221	220 $\pm$ 20%	694m(555m)	0.85	0.72	0.68
CDRH104RT125NP-331MC	331	330 $\pm$ 20%	1.06(850m)	0.70	0.58	0.56

※ 1 Measuring condition: at 100kHz.

※ 2 ( ) are typical value.

※ 3 Saturation current: The value of D.C. current when the inductance decreases to 65% of it's nominal value.

※ 4 Temperature rise current: The value of D.C. current when the temperature rise is  $\Delta t=40^\circ\text{C}$  ( $T_a=20^\circ\text{C}$ ).

# SMD Power Inductor CDRH104R/T125



## Saturation Current & Temperature Rise Graph

— L (20°C) — L (125°C) —  $\Delta T$

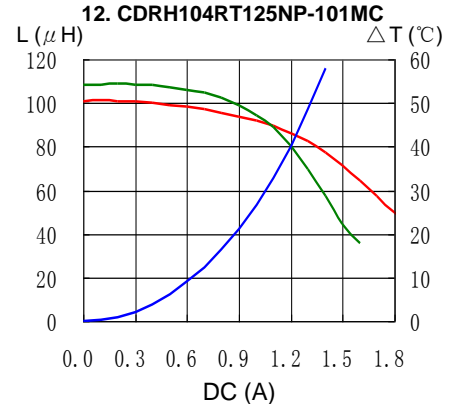
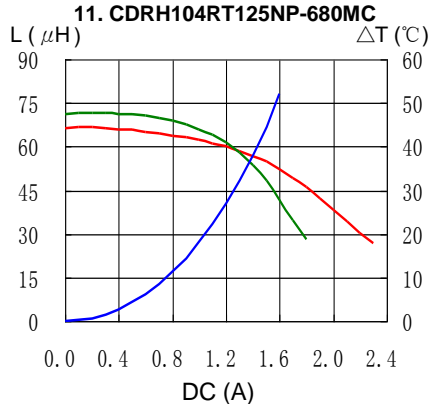
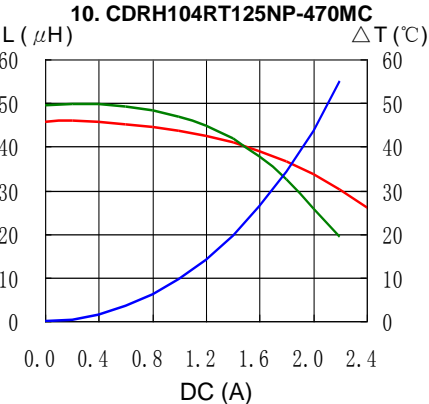
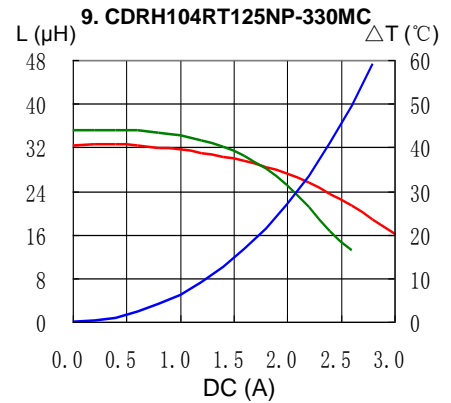
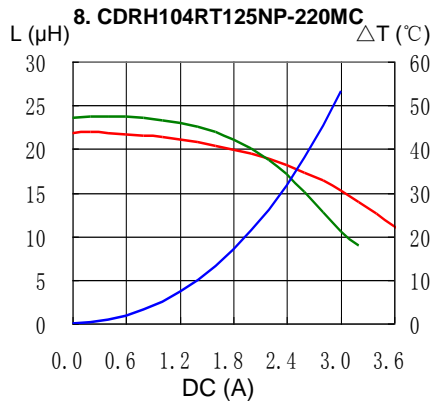
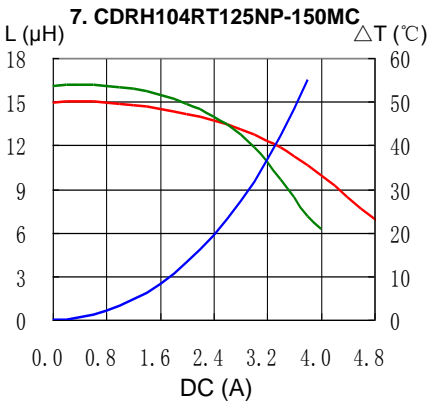
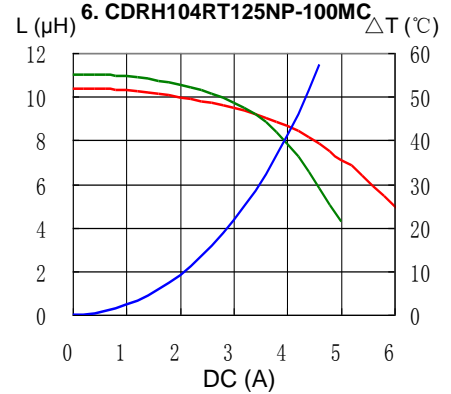
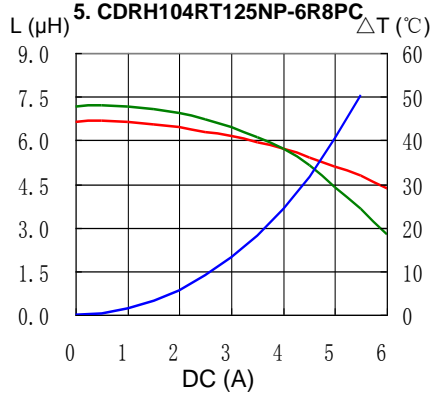
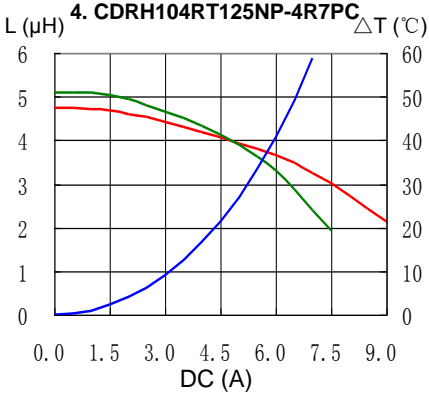
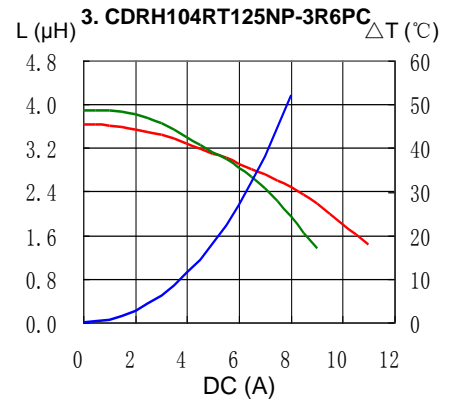
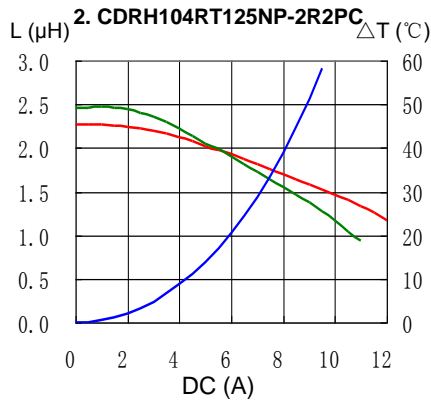
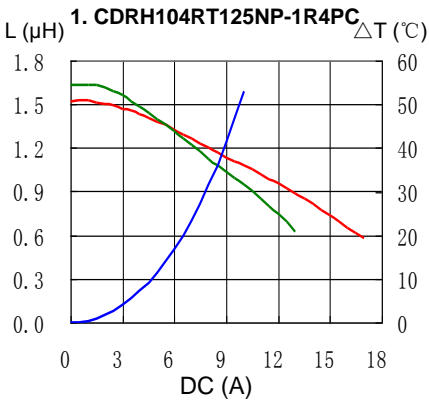

# SMD Power Inductor CDRH104R/T125

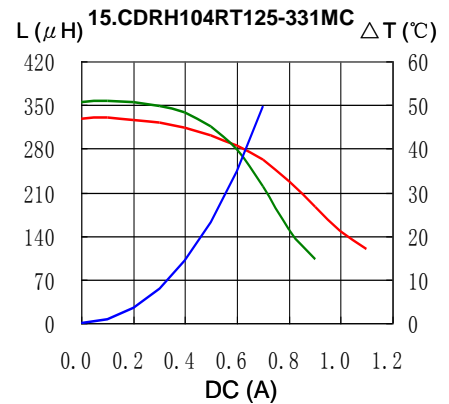
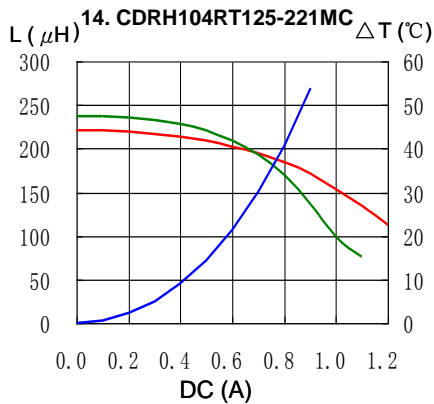
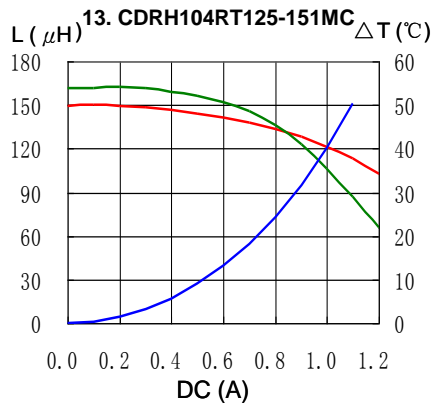

## Solder Reflow Condition

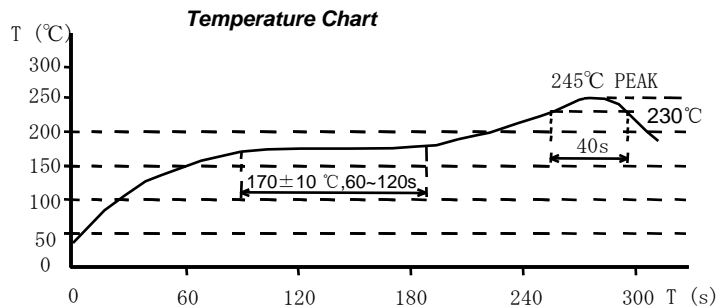
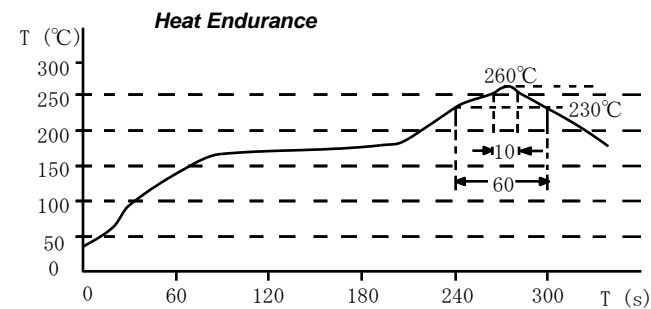

Please refer to the sales offices on our website - <http://www.sumida.com>

### Hong Kong

Tel.+852-2880-6781  
FAX.+852-2565-9600  
[sales@hk.sumida.com](mailto:sales@hk.sumida.com)

### Saitama(Japan)

Tel.+81-48-691-7300  
FAX.+81-48-691-7340  
[sales@jp.sumida.com](mailto:sales@jp.sumida.com)

### Chicago

Tel.+1-847-545-6700  
FAX. +1-847-545-6720  
[sales@us.sumida.com](mailto:sales@us.sumida.com)

### Shanghai

Tel.+86-21-5836-3299  
FAX.+86-21-5836-3266  
[shanghai.sales@cn.sumida.com](mailto:shanghai.sales@cn.sumida.com)

### Seoul

Tel.+82-2-6237-0777  
FAX.+82-2-6237-0778  
[sales@kr.sumida.com](mailto:sales@kr.sumida.com)

### Obernzell

Tel.+49-8591-937-0  
FAX. +49-8591-937-103  
[contact@eu.sumida.com](mailto:contact@eu.sumida.com)

### Shenzhen

Tel.+86-755-8291-0228  
FAX.+86-755-8291-0338  
[shenzhen.sales@cn.sumida.com](mailto:shenzhen.sales@cn.sumida.com)

### Singapore

Tel.+65-6296-3388  
FAX.+65-6841-4426  
[sales@sg.sumida.com](mailto:sales@sg.sumida.com)

### Neumarkt

Tel.+49-9181-4509-110  
FAX. +49-9181-4509-310  
[infocomp@eu.sumida.com](mailto:infocomp@eu.sumida.com)

### Taipei

Tel.+886-2-8751-2737  
FAX.+886-2-8751-2738  
[sales@tw.sumida.com](mailto:sales@tw.sumida.com)

### San Jose

Tel.+1-408-321-9660  
FAX.+1-408-321-9308  
[sales@us.sumida.com](mailto:sales@us.sumida.com)

## X-ON Electronics

Largest Supplier of Electrical and Electronic Components

*Click to view similar products for [Fixed Inductors](#) category:*

*Click to view products by [Sumida](#) manufacturer:*

Other Similar products are found below :

[CR32NP-100KC](#) [CR32NP-151KC](#) [CR32NP-180KC](#) [CR32NP-181KC](#) [CR32NP-1R5MC](#) [CR32NP-390KC](#) [CR32NP-3R9MC](#) [CR32NP-680KC](#) [CR32NP-820KC](#) [CR32NP-8R2MC](#) [CR43NP-390KC](#) [CR43NP-560KC](#) [CR43NP-680KC](#) [CR54NP-181KC](#) [CR54NP-470LC](#) [CR54NP-820KC](#) [CR54NP-8R5MC](#) [70F224AI](#) [MGDQ4-00004-P](#) [MHL1ECTTP18NJ](#) [MHQ1005P10NJ](#) [MHQ1005P1N0S](#) [MHQ1005P2N4S](#) [MHQ1005P3N6S](#) [MHQ1005P5N1S](#) [MHQ1005P8N2J](#) [PE-51506NL](#) [PE-53601NL](#) [PE-53602NL](#) [PE-53630NL](#) [PE-53824SNLT](#) [PE-92100NL](#) [PG0434.801NLT](#) [PG0936.113NLT](#) [9220-20](#) [9310-16](#) [PM06-2N7](#) [PM06-39NJ](#) [A01TK](#) [1206CS-471XJ](#) [HC2LP-R47-R](#) [HC2-R47-R](#) [HC3-2R2-R](#) [HCF1305-3R3-R](#) [1206CS-151XG](#) [RCH664NP-140L](#) [RCH664NP-4R7M](#) [RCH8011NP-221L](#) [RCP1317NP-332L](#) [RCP1317NP-391L](#)