

SMD Power Inductor CDRH104R/T125

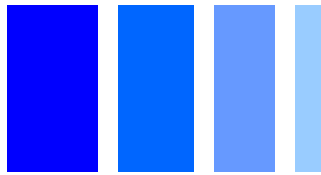

Description

- Ferrite drum core construction.
- Magnetically shielded.
- L x W x H: 10.5 x 10.3 x 4.0 mm Max.
- Product weight: 1.5g(Ref.)
- Moisture Sensitivity Level: 1
- RoHS compliance.
- Qualified to AEC-Q200.

Dimension - [mm]

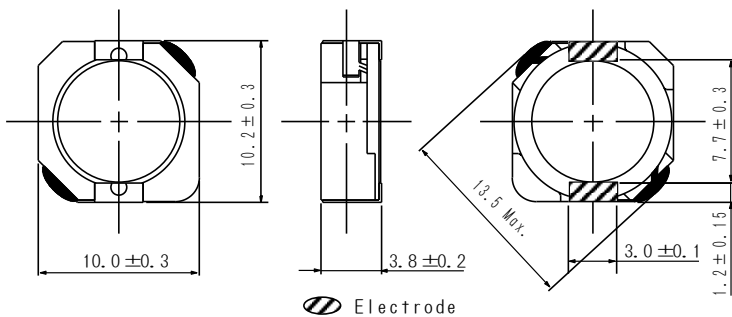

Environmental Data

- Operating temperature range: -40°C ~ +125°C (including coil's self temperature rise)
- Storage temperature range: -40°C ~ +125°C
- Solder reflow temperature: 260 °C peak.

Packaging

- Carrier tape and reel packaging
- 13" diameter reel
- 1000pcs per reel

Applications

- Automotive.

Land pattern and Schematics - [mm]

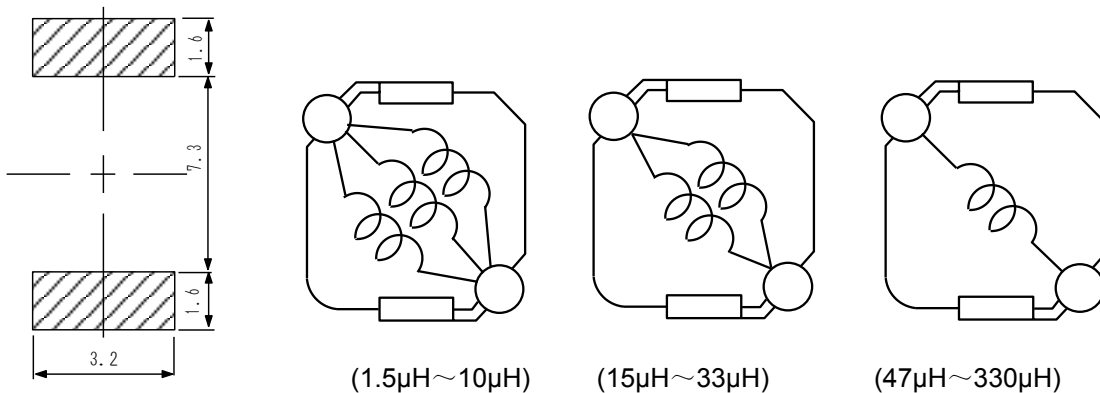

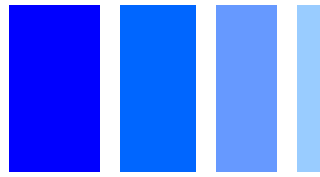

Electrical Characteristics

Part No.	Stamp	Inductance (μH) [Within] ※1	D.C.R. (Ω) [Max.] (at 20°C) ※2	Rated current (A)		
				Saturation current (A) ※3		Temperature rise current (A) ※4
				(at 20°C)	(at 125°C) (Typ.)	
CDRH104RT125NP-1R4PC	1R4	1.4 \pm 25%	9.0m(7.2m)	9.20	7.36	7.80
CDRH104RT125NP-2R2PC	2R2	2.2 \pm 25%	11.0m(8.8m)	8.00	6.16	7.10
CDRH104RT125NP-3R6PC	3R6	3.6 \pm 25%	14.0m(11.2m)	6.07	5.00	6.20
CDRH104RT125NP-4R7PC	4R7	4.7 \pm 25%	19.1m(15.3m)	5.57	4.60	5.20
CDRH104RT125NP-6R8PC	6R8	6.8 \pm 25%	25.6m(20.5m)	4.66	3.94	4.40
CDRH104RT125NP-100MC	100	10 \pm 20%	36.8m(29.5m)	4.10	3.46	3.50
CDRH104RT125NP-150MC	150	15 \pm 20%	48.1m(38.5m)	3.34	2.80	2.90
CDRH104RT125NP-220MC	220	22 \pm 20%	70.0m(56.0m)	2.56	2.18	2.30
CDRH104RT125NP-330MC	330	33 \pm 20%	93.8m(75.0m)	2.14	1.80	2.05
CDRH104RT125NP-470MC	470	47 \pm 20%	136m(109m)	1.80	1.51	1.68
CDRH104RT125NP-680MC	680	68 \pm 20%	216m(173m)	1.57	1.32	1.25
CDRH104RT125NP-101MC	101	100 \pm 20%	300m(240m)	1.30	1.10	1.05
CDRH104RT125NP-151MC	151	150 \pm 20%	448m(358m)	1.00	0.85	0.86
CDRH104RT125NP-221MC	221	220 \pm 20%	694m(555m)	0.85	0.72	0.68
CDRH104RT125NP-331MC	331	330 \pm 20%	1.06(850m)	0.70	0.58	0.56

※ 1 Measuring condition: at 100kHz.

※ 2 () are typical value.

※ 3 Saturation current: The value of D.C. current when the inductance decreases to 65% of it's nominal value.

※ 4 Temperature rise current: The value of D.C. current when the temperature rise is $\Delta t=40^\circ\text{C}$ ($T_a=20^\circ\text{C}$).

SMD Power Inductor CDRH104R/T125



Saturation Current & Temperature Rise Graph

— L (20°C) — L (125°C) — ΔT

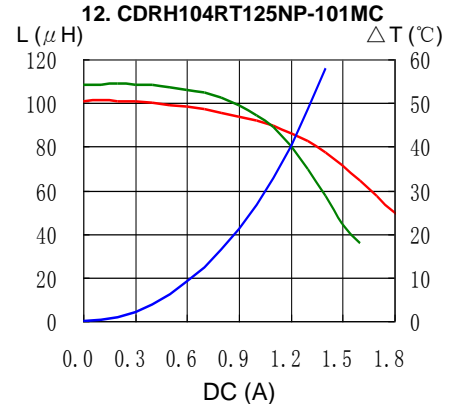
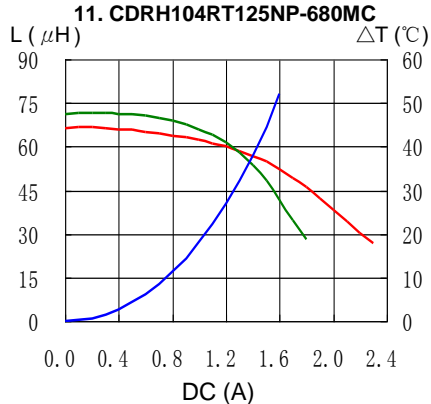
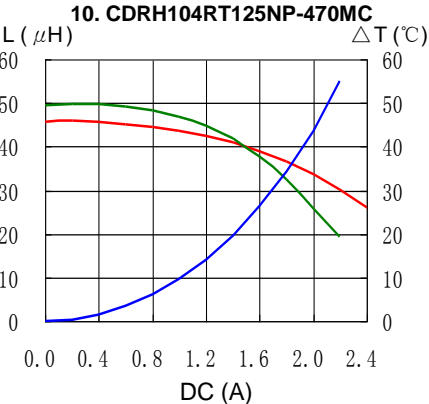
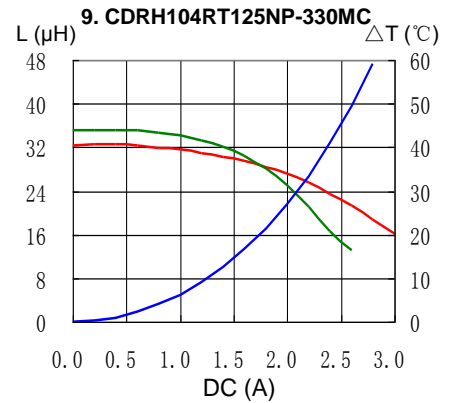
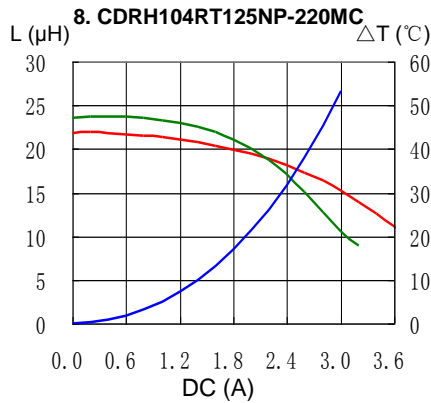
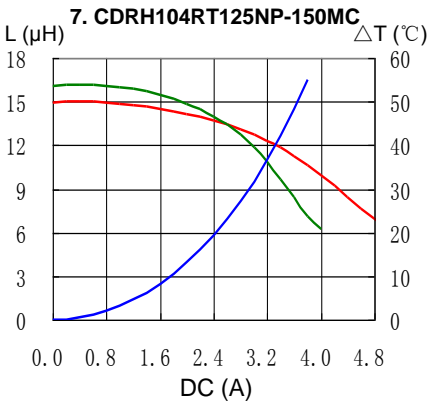
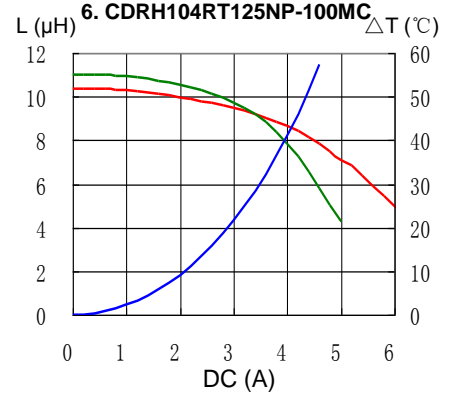
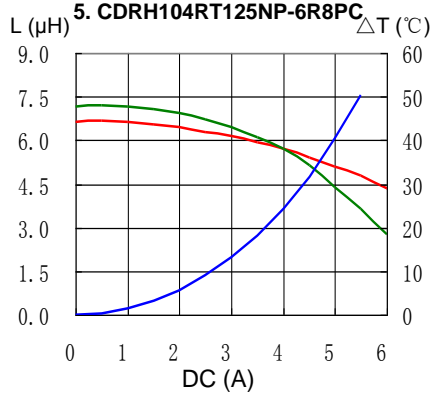
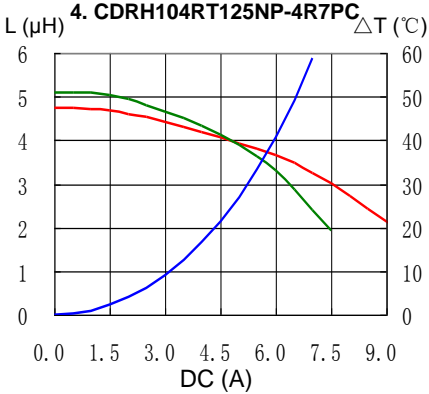
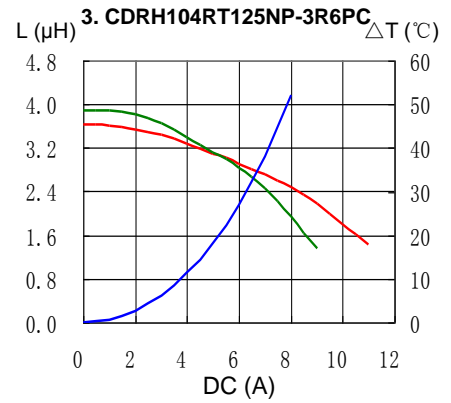
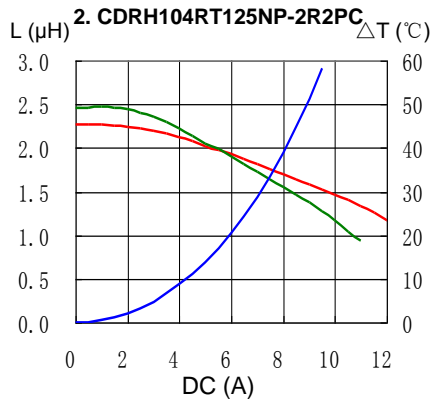
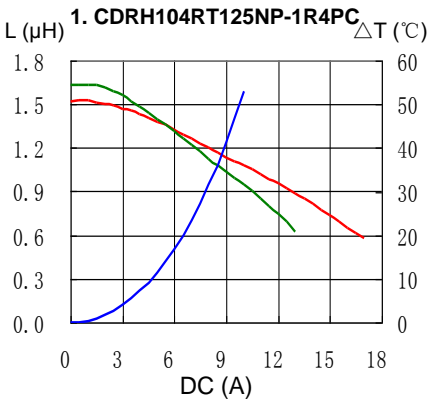

SMD Power Inductor CDRH104R/T125

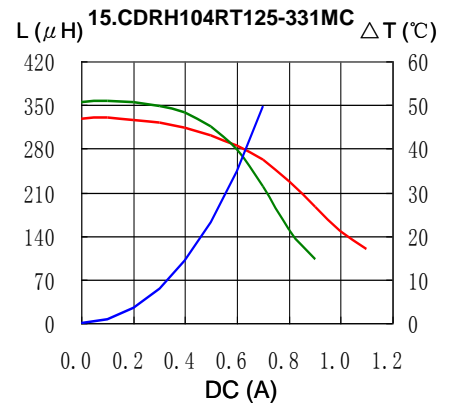
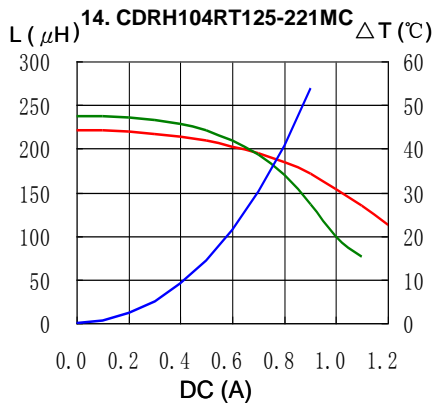
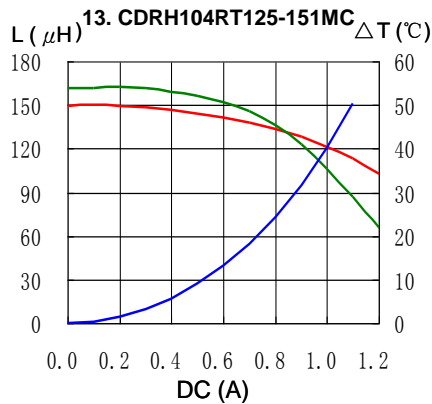

Solder Reflow Condition

Heat Endurance

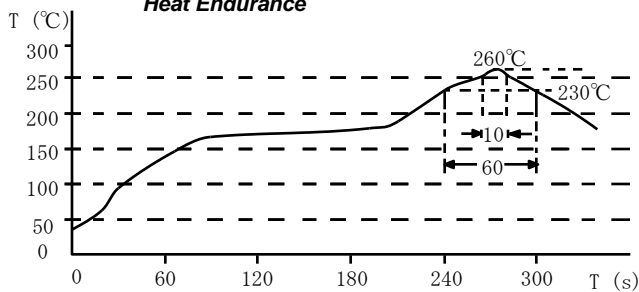

Temperature Chart

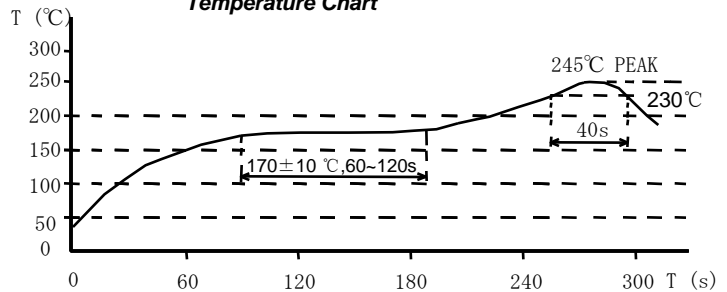

Please refer to the sales offices on our website - <http://www.sumida.com>

Hong Kong

Tel.+852-2880-6781
FAX.+852-2565-9600
sales@hk.sumida.com

Saitama(Japan)

Tel.+81-48-691-7300
FAX.+81-48-691-7340
sales@jp.sumida.com

Chicago

Tel.+1-847-545-6700
FAX. +1-847-545-6720
sales@us.sumida.com

Shanghai

Tel.+86-21-5836-3299
FAX.+86-21-5836-3266
shanghai.sales@cn.sumida.com

Seoul

Tel.+82-2-6237-0777
FAX.+82-2-6237-0778
sales@kr.sumida.com

Obernzell

Tel.+49-8591-937-0
FAX. +49-8591-937-103
contact@eu.sumida.com

Shenzhen

Tel.+86-755-8291-0228
FAX.+86-755-8291-0338
shenzhen.sales@cn.sumida.com

Singapore

Tel.+65-6296-3388
FAX.+65-6841-4426
sales@sg.sumida.com

Neumarkt

Tel.+49-9181-4509-110
FAX. +49-9181-4509-310
infocomp@eu.sumida.com

Taipei

Tel.+886-2-8751-2737
FAX.+886-2-8751-2738
sales@tw.sumida.com

San Jose

Tel.+1-408-321-9660
FAX.+1-408-321-9308
sales@us.sumida.com

X-ON Electronics

Largest Supplier of Electrical and Electronic Components

Click to view similar products for [Fixed Inductors](#) category:

Click to view products by [Sumida](#) manufacturer:

Other Similar products are found below :

[CR43NP-680KC](#) [CR54NP-470LC](#) [CR54NP-820KC](#) [CR54NP-8R5MC](#) [70F224AI](#) [MGDQ4-00004-P](#) [MHL1ECTTP18NJ](#) [MHQ1005P10NJ](#)
[MHQ1005P1N0S](#) [MHQ1005P2N4S](#) [MHQ1005P3N6S](#) [MHQ1005P5N1S](#) [MHQ1005P8N2J](#) [PE-51506NL](#) [PE-53601NL](#) [PE-53602NL](#) [PE-](#)
[53630NL](#) [PE-53824SNLT](#) [PE-92100NL](#) [PG0434.801NLT](#) [PG0936.113NLT](#) [9220-20](#) [9310-16](#) [PM06-2N7](#) [PM06-39NJ](#) [A01TK](#) [1206CS-](#)
[471XJ](#) [HC2LP-R47-R](#) [HC2-R47-R](#) [HC3-2R2-R](#) [HC3-R50-R](#) [HC8-1R2-R](#) [HCF1305-3R3-R](#) [1206CS-151XG](#) [RCH664NP-140L](#) [RCH664NP-](#)
[4R7M](#) [RCH8011NP-221L](#) [RCP1317NP-332L](#) [RCP1317NP-391L](#) [RCR1010NP-470M](#) [RCR110DNP-331L](#) [DH2280-4R7M](#) [DS1608C-106](#)
[ASPI-4020HI-R10M-T](#) [B10TJ](#) [B82498B3101J000](#) [ELJ-RE27NJF2](#) [1812CS-153XJ](#) [1812CS-183XJ](#) [1812CS-223XJ](#)