

SMD Power Inductor CDRH10D68



Description

- Ferrite drum core construction.
- Magnetically shielded.
- L × W × H: 10.5 × 10.5 × 7.1 mm Max.
- Product weight: 2.6g(Ref.)
- Moisture Sensitivity Level: 1
- RoHS compliance.

Environmental Data

- Operating temperature range: -40°C ~ +105°C (including coil's self temperature rise)
- Storage temperature range: -40°C ~ +105°C
- Solder reflow temperature: 260 °C peak.

Dimension - [mm]

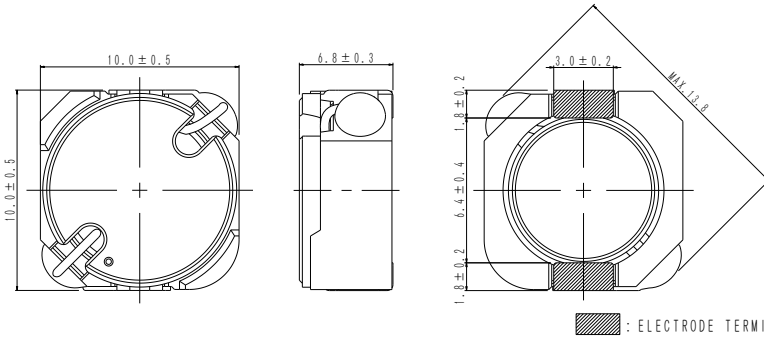

Packaging

- Carrier tape and reel packaging
- 12.9" diameter reel
- 500pcs per reel

Applications

- Ideally Used in Notebook PC, DSC/DVC, Game Machine, etc as DC-DC converter inductors.

Land pattern and Schematics - [mm]

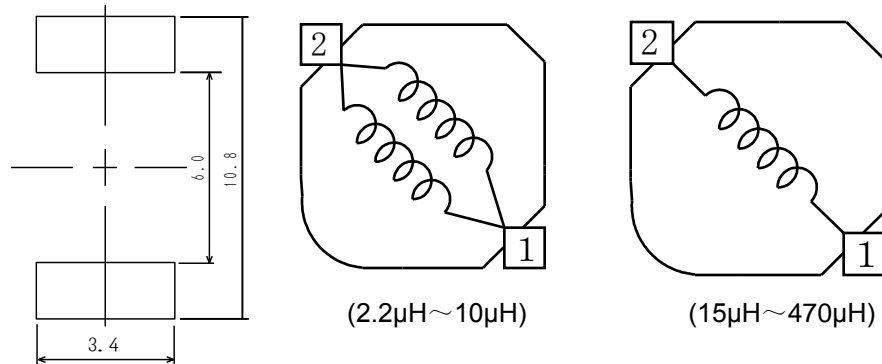

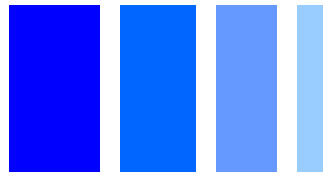

Electrical Characteristics

| Part Name | Stamp | Inductance (μH) [within] ※1 | D.C.R. (m Ω) Max. (Typ.) (at 20°C) | Saturation Current (A) ※2 | | Temperature Rise Current (A) ※3 |
|-------------------|-------|--|--|------------------------------|----------|---------------------------------------|
| | | | | at 20°C | at 105°C | |
| CDRH10D68NP-2R2NC | 2R2 | 2.2 \pm 25% | 7.20(5.7) | 9.8 | 8.0 | 9.0 |
| CDRH10D68NP-3R3NC | 3R3 | 3.3 \pm 25% | 8.50(6.8) | 8.4 | 6.8 | 8.0 |
| CDRH10D68NP-4R7NC | 4R7 | 4.7 \pm 25% | 9.80(7.9) | 7.9 | 6.5 | 7.0 |
| CDRH10D68NP-6R0NC | 6R0 | 6.0 \pm 25% | 14.0(11.2) | 6.5 | 5.2 | 5.5 |
| CDRH10D68NP-8R2NC | 8R2 | 8.2 \pm 25% | 15.8(12.7) | 5.1 | 4.0 | 5.3 |
| CDRH10D68NP-100MC | 100 | 10 \pm 20% | 21.5(17.2) | 4.8 | 3.8 | 4.4 |
| CDRH10D68NP-150MC | 150 | 15 \pm 20% | 34.5(27.6) | 4.5 | 3.6 | 3.6 |
| CDRH10D68NP-180MC | 180 | 18 \pm 20% | 37.0(29.7) | 3.6 | 2.9 | 3.4 |
| CDRH10D68NP-220MC | 220 | 22 \pm 20% | 40.2(32.1) | 3.0 | 2.6 | 3.2 |
| CDRH10D68NP-330MC | 330 | 33 \pm 20% | 60.4(48.3) | 2.7 | 2.2 | 2.6 |
| CDRH10D68NP-470MC | 470 | 47 \pm 20% | 106.3(85.0) | 2.4 | 2.0 | 2.1 |
| CDRH10D68NP-680MC | 680 | 68 \pm 20% | 149.8(119.8) | 2.0 | 1.6 | 1.7 |
| CDRH10D68NP-820MC | 820 | 82 \pm 20% | 163.3(130.6) | 1.7 | 1.4 | 1.6 |
| CDRH10D68NP-101MC | 101 | 100 \pm 20% | 205.0(164.3) | 1.5 | 1.2 | 1.5 |
| CDRH10D68NP-151MC | 151 | 150 \pm 20% | 291.9(233.5) | 1.3 | 1.1 | 1.3 |
| CDRH10D68NP-181MC | 181 | 180 \pm 20% | 325.7(260.6) | 1.2 | 0.9 | 1.2 |
| CDRH10D68NP-221MC | 221 | 220 \pm 20% | 362.4(290.0) | 1.0 | 0.8 | 1.1 |
| CDRH10D68NP-331MC | 331 | 330 \pm 20% | 525.1(420.1) | 0.8 | 0.6 | 0.9 |
| CDRH10D68NP-471MC | 471 | 470 \pm 20% | 739.6(591.7) | 0.7 | 0.5 | 0.8 |

※1 Inductance measuring condition: at 100kHz.

※2 The saturation current: This indicates the value of DC current when the inductance decreases to 65% of it's nominal.

※3 The temperature rise: The value of DC current when the temperature rise is $\Delta T=40^\circ\text{C}$ ($T_a=20^\circ\text{C}$).

SMD Power Inductor CDRH10D68

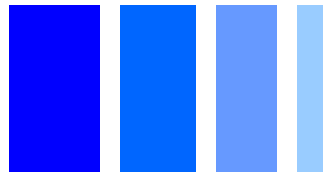

Saturation Current & Temperature Rise Graph

— L (20°C) — L (100°C) — ΔT

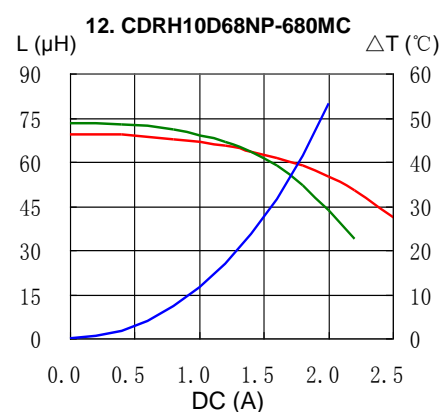
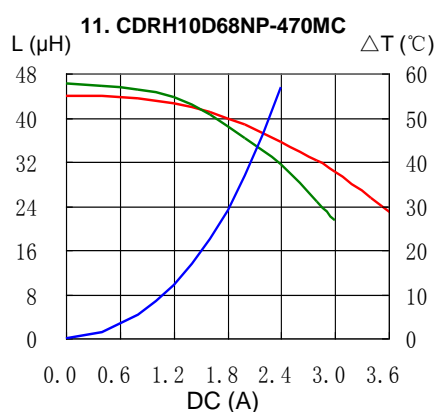
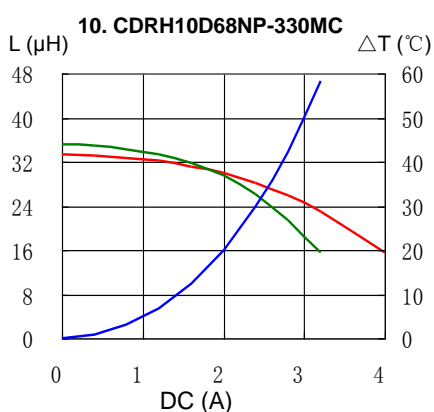
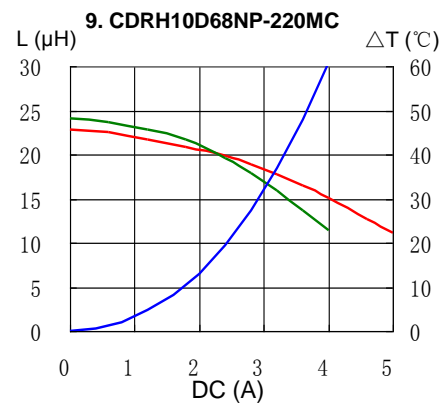
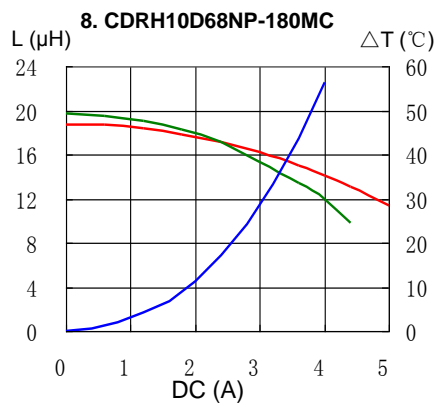
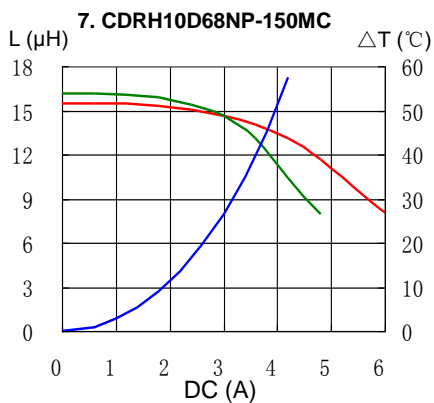
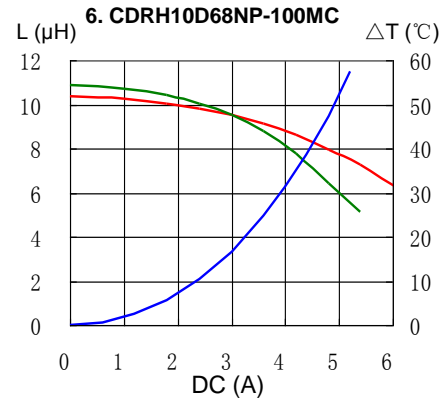
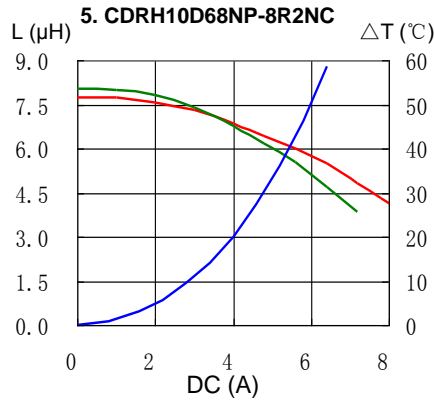
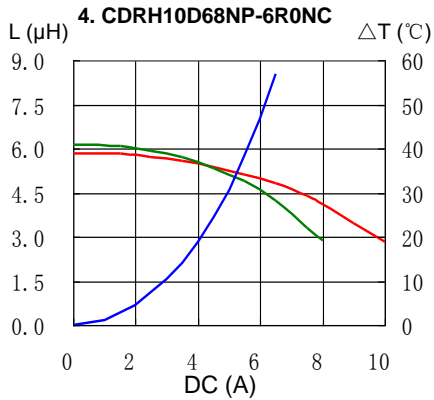
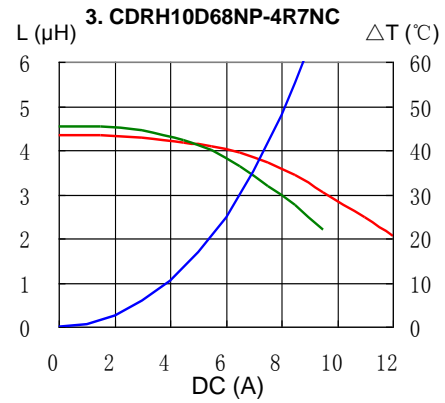
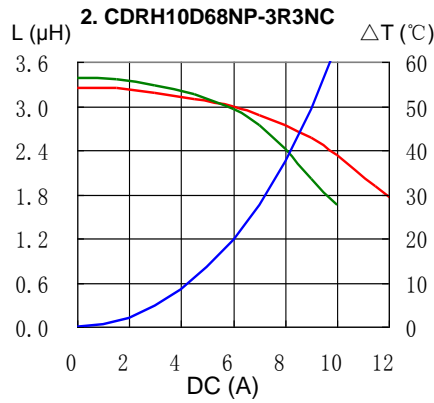
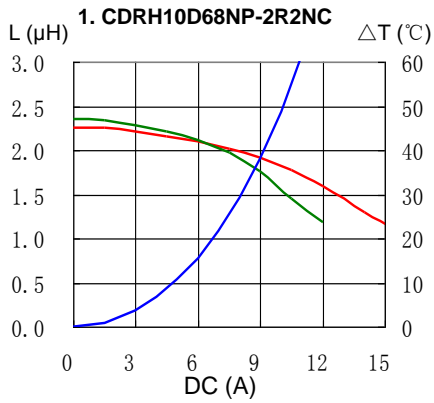

SMD Power Inductor CDRH10D68



Saturation Current & Temperature Rise Graph

— L (20°C) — L (100°C) — ΔT

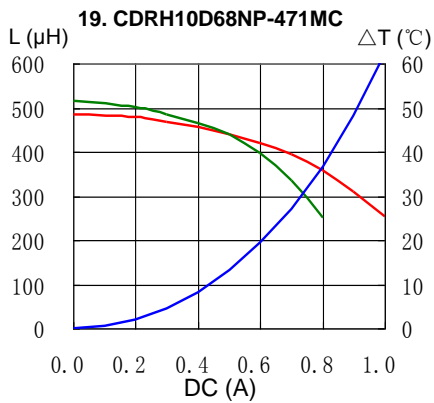
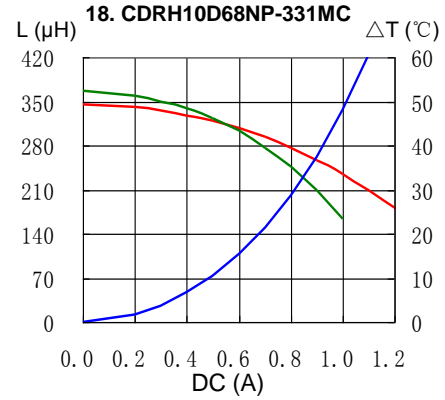
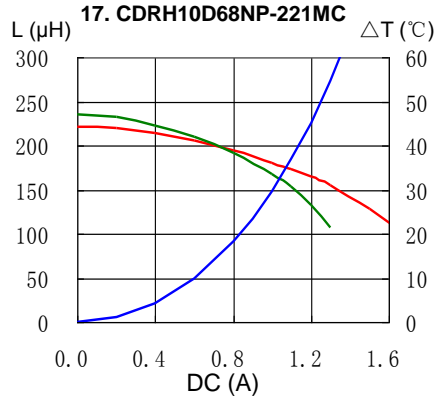
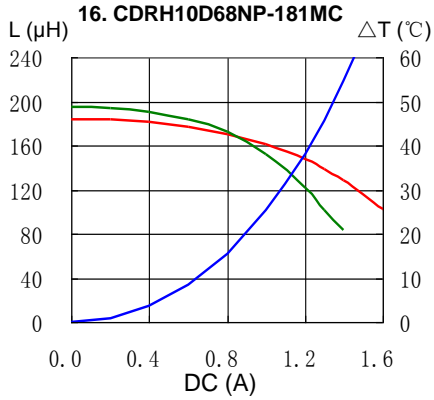
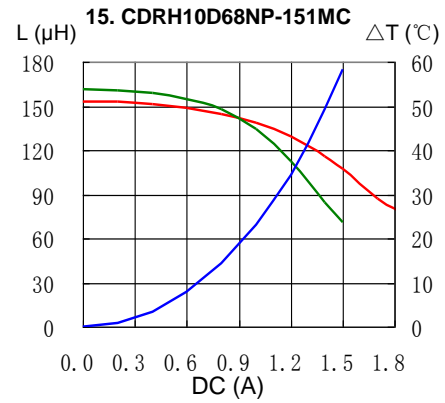
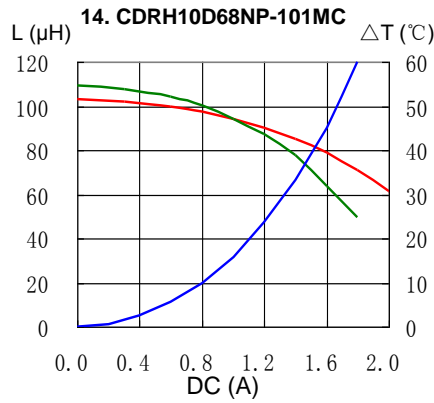
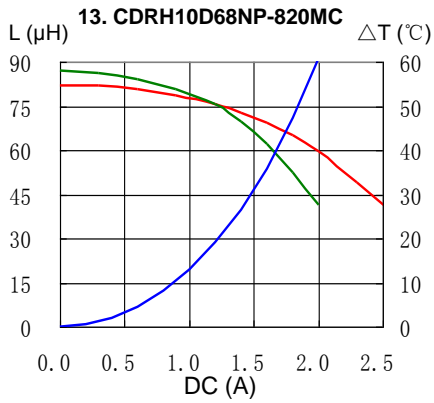

SMD Power Inductor CDRH10D68



Solder Reflow Condition

Heat Endurance

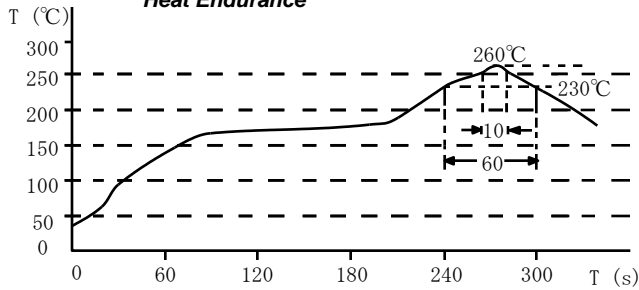

Temperature Chart

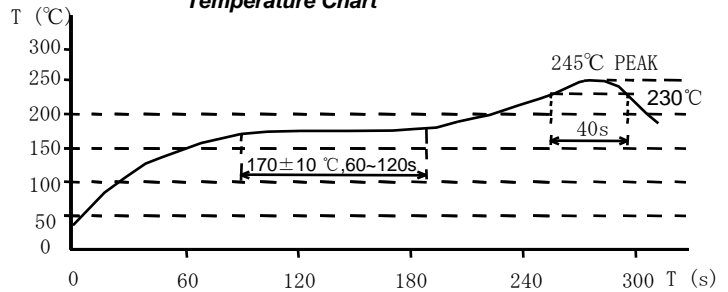

Please refer to the sales offices on our website - <http://www.sumida.com>

Hong Kong

Tel.+852-2880-6781
FAX.+852-2565-9600
sales@hk.sumida.com

Saitama(Japan)

Tel.+81-48-691-7300
FAX.+81-48-691-7340
sales@jp.sumida.com

Chicago

Tel.+1-847-545-6700
FAX. +1-847-545-6720
sales@us.sumida.com

Shanghai

Tel.+86-21-5836-3299
FAX.+86-21-5836-3266
shanghai.sales@cn.sumida.com

Seoul

Tel.+82-2-6237-0777
FAX.+82-2-6237-0778
sales@kr.sumida.com

Obernzell

Tel.+49-8591-937-0
FAX. +49-8591-937-103
contact@eu.sumida.com

Shenzhen

Tel.+86-755-8291-0228
FAX.+86-755-8291-0338
shenzhen.sales@cn.sumida.com

Singapore

Tel.+65-6296-3388
FAX.+65-6841-4426
sales@sg.sumida.com

Neumarkt

Tel.+49-9181-4509-110
FAX. +49-9181-4509-310
infocomp@eu.sumida.com

Taipei

Tel.+886-2-8751-2737
FAX.+886-2-8751-2738
sales@tw.sumida.com

San Jose

Tel.+1-408-321-9660
FAX.+1-408-321-9308
sales@us.sumida.com

X-ON Electronics

Largest Supplier of Electrical and Electronic Components

Click to view similar products for [Fixed Inductors](#) category:

Click to view products by [Sumida](#) manufacturer:

Other Similar products are found below :

[CR43NP-680KC](#) [CR54NP-820KC](#) [CR54NP-8R5MC](#) [CTX32CT-100](#) [70F224AI](#) [MGDQ4-00004-P](#) [MHL1ECTTP18NJ](#) [MHL1JCTTD12NJ](#)
[PE-51506NL](#) [PE-53601NL](#) [PE-53602NL](#) [PE-53630NL](#) [PE-53824SNLT](#) [PE-92100NL](#) [PG0434.801NLT](#) [PG0936.113NLT](#) [9310-16](#) [PM06-2N7](#) [PM06-39NJ](#) [A01TK](#) [1206CS-471XJ](#) [HC2-2R2TR](#) [HC2LP-R47-R](#) [HC3-2R2-R](#) [1206CS-151XG](#) [RCH664NP-140L](#) [RCH664NP-4R7M](#)
[RCH8011NP-221L](#) [RCP1317NP-332L](#) [RCP1317NP-391L](#) [RCR1010NP-470M](#) [RCR110DNP-331L](#) [DH2280-4R7M](#) [DS1608C-106](#) [ASPI-4020HI-R10M-T](#) [B10TJ](#) [B82477P4333M](#) [B82498B3101J000](#) [B82498B3680J000](#) [ELJ-RE27NJF2](#) [1812CS-153XJ](#) [1812CS-183XJ](#) [1812CS-223XJ](#) [1812LS-104XJ](#) [1812LS-105XJ](#) [1812LS-124XJ](#) [1812LS-154XJ](#) [1812LS-223XJ](#) [1812LS-224XJ](#) [1812LS-563XJ](#)