

SMD Power Inductor

CDRH10D68R/T125



Description

- Ferrite drum core construction.
- Magnetically shielded.
- L × W × H: 10.6 × 10.6 × 7.0 mm Max.
- Product weight: 2.7g(Ref.)
- Moisture Sensitivity Level: 1
- RoHS compliance.
- Qualified with AEC-Q200.

Dimension - [mm]

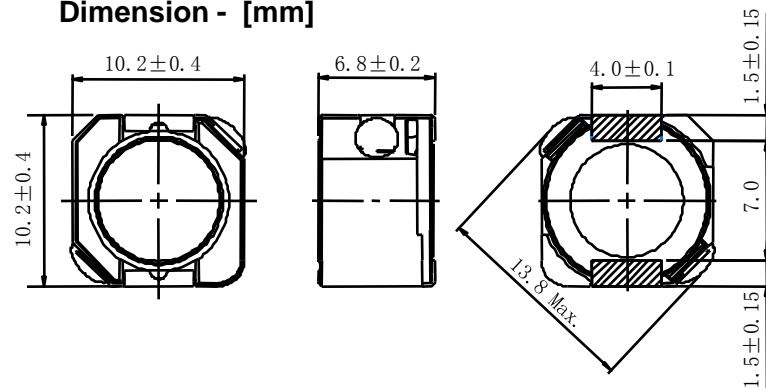

Environmental Data

- Operating temperature range: -40°C ~ +125°C (including coil's self temperature rise)
- Storage temperature range: -40°C ~ +125°C
- Solder reflow temperature: 260 °C peak.

Packaging

- Carrier tape and reel packaging

Applications

- Automotive.

Land pattern and Schematics - [mm]

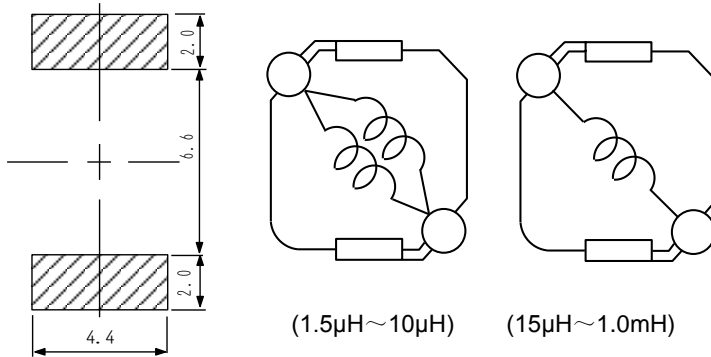

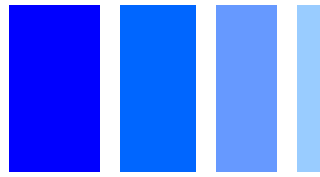

Electrical Characteristics

Part No.	Stamp	Inductance (μH) [Within] ※1	D.C.R. ($\text{m}\Omega$)[Max.] (at20°C) ※2	Saturation current (A) ※3		Temperature rise current (A) ※4
				(at20°C)	(at125°C) (Typ)	
CDRH10D68RT125NP-1R5NC	1R5	1.5±30%	6.1(4.9)	11.00	8.50	10.50
CDRH10D68RT125NP-2R2NC	2R2	2.2±30%	7.1(5.7)	10.50	7.50	9.50
CDRH10D68RT125NP-3R3NC	3R3	3.3±30%	8.5(6.8)	7.80	5.60	8.30
CDRH10D68RT125NP-4R7NC	4R7	4.7±30%	9.9(7.9)	7.15	5.17	7.60
CDRH10D68RT125NP-6R2NC	6R2	6.2±30%	14.2(11.3)	5.95	4.14	6.45
CDRH10D68RT125NP-7R5NC	7R5	7.5±30%	16.4(13.0)	5.50	3.89	5.55
CDRH10D68RT125NP-100PC	100	10±25%	21.4(17.1)	4.40	3.60	4.40
CDRH10D68RT125NP-150PC	150	15±25%	30.6(24.5)	3.60	2.85	3.60
CDRH10D68RT125NP-220PC	220	22±25%	39.1(31.3)	3.10	2.47	3.10
CDRH10D68RT125NP-330PC	330	33±25%	59.1(47.3)	2.60	1.85	2.60
CDRH10D68RT125NP-470PC	470	47±25%	88.3(70.6)	2.00	1.60	2.00
CDRH10D68RT125NP-680PC	680	68±25%	125(100)	1.80	1.24	1.80
CDRH10D68RT125NP-101PC	101	100±25%	175(140)	1.50	1.05	1.50
CDRH10D68RT125NP-151PC	151	150±25%	250(200)	1.23	0.86	1.23
CDRH10D68RT125NP-221PC	221	220±25%	370(296)	1.00	0.73	1.00
CDRH10D68RT125NP-331PC	331	330±25%	465(372)	0.80	0.55	0.91
CDRH10D68RT125NP-471PC	471	470±25%	703(562)	0.68	0.50	0.72
CDRH10D68RT125NP-681PC	681	680±25%	1030(828)	0.60	0.40	0.61
CDRH10D68RT125NP-102PC	102	1000±25%	1560(1253)	0.45	0.33	0.49

※ 1 Measuring frequency inductance at 100kHz.

※ 2 () are typical value

※ 3 Saturation current: The value of D.C. current when the inductance decreases to 65% of its nominal value.

※ 4 Temperature rise current: The value of D.C. current when the temperature rise is $\Delta t=40^\circ\text{C}$ ($T_a=20^\circ\text{C}$).

SMD Power Inductor CDRH10D68R/T125



Saturation Current & Temperature Rise Graph

— L (20°C) — L (125°C) — ΔT

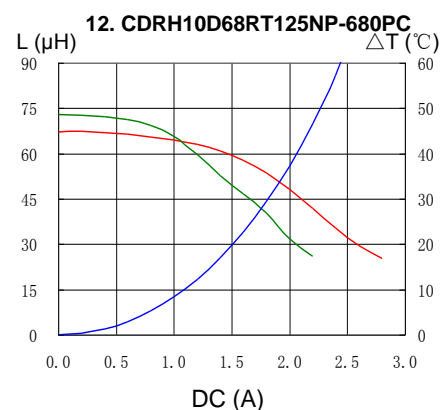
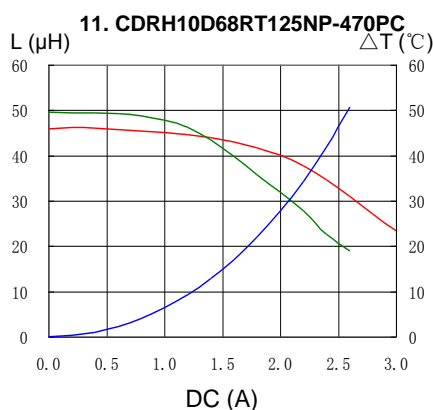
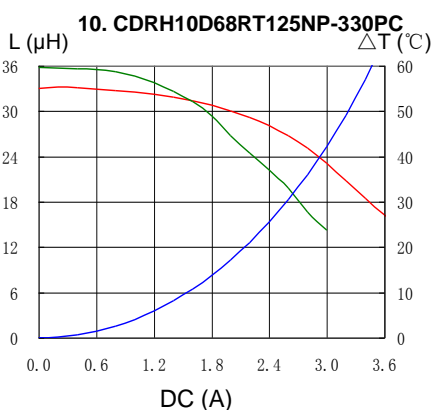
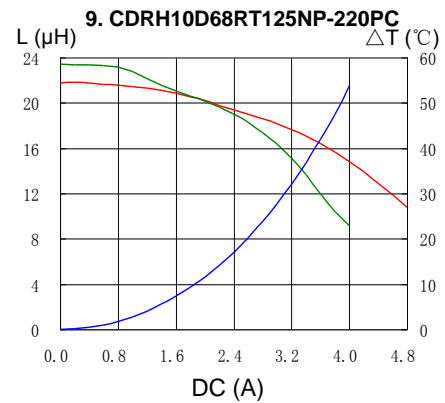
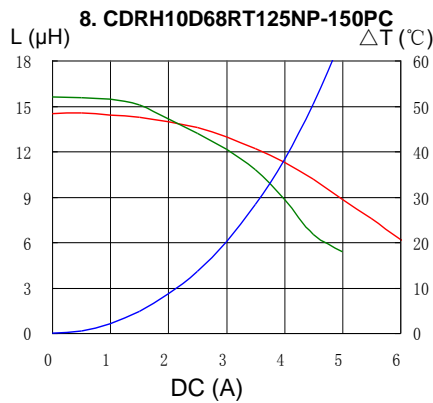
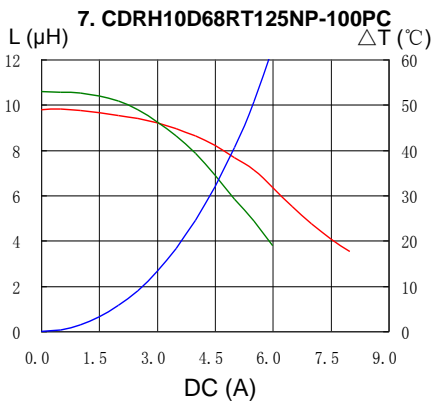
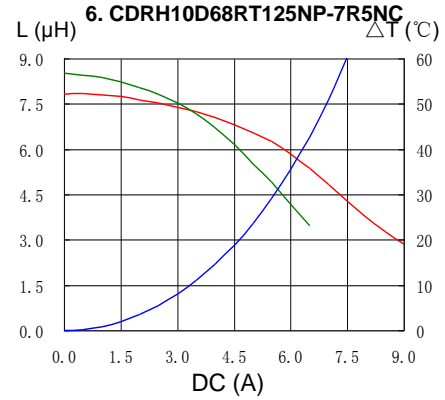
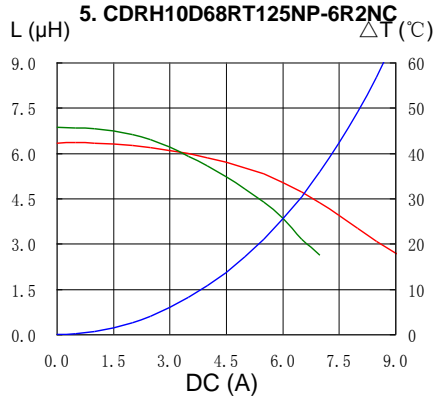
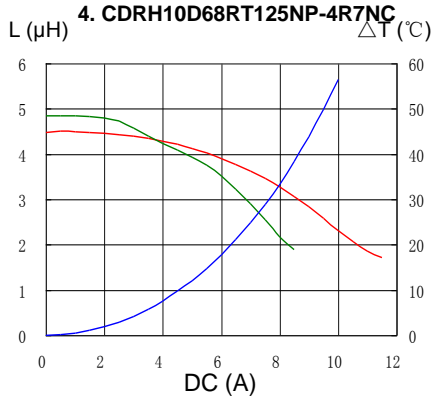
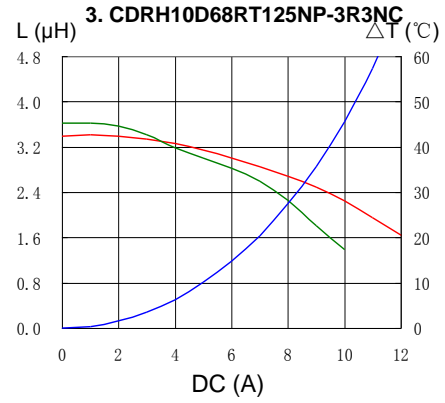
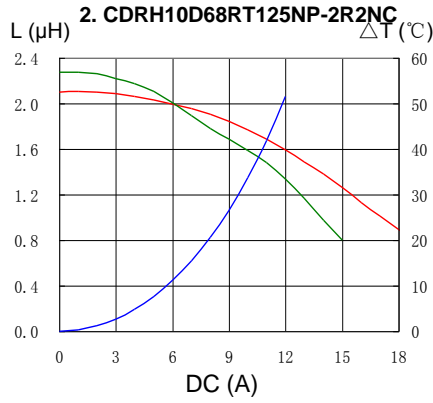
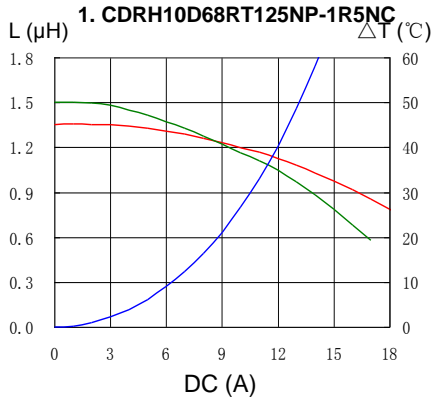

SMD Power Inductor CDRH10D68R/T125



Saturation Current & Temperature Rise Graph

— L (20°C) — L (125°C) — ΔT

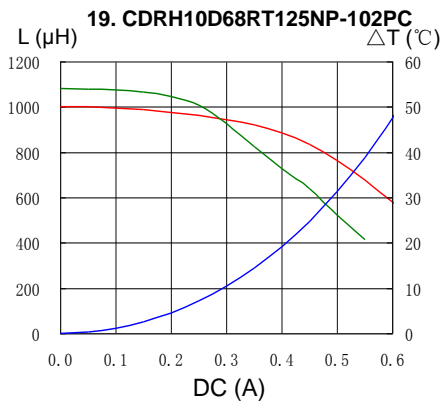
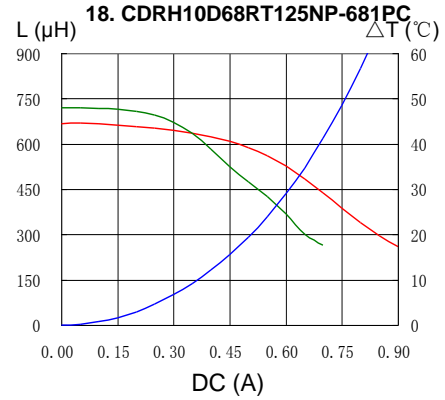
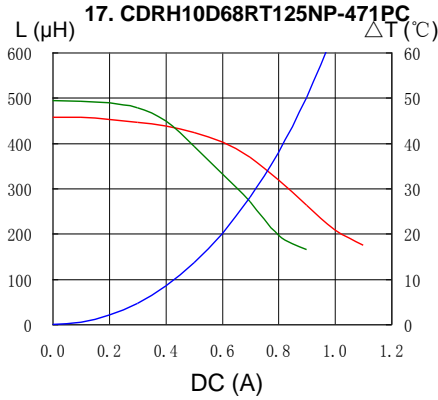
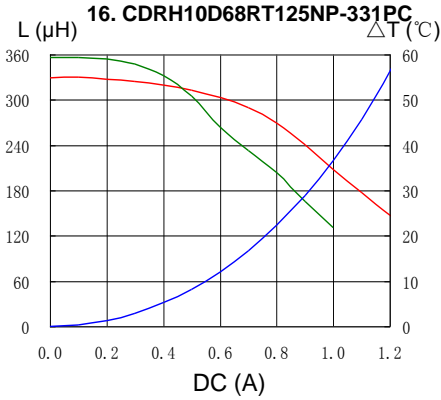
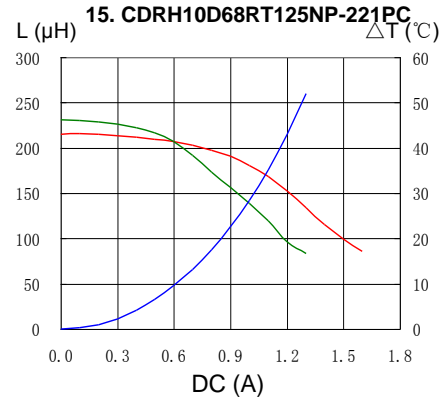
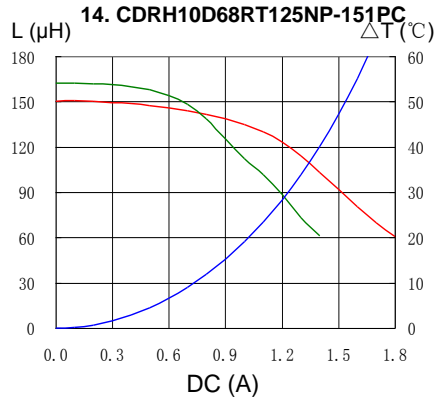
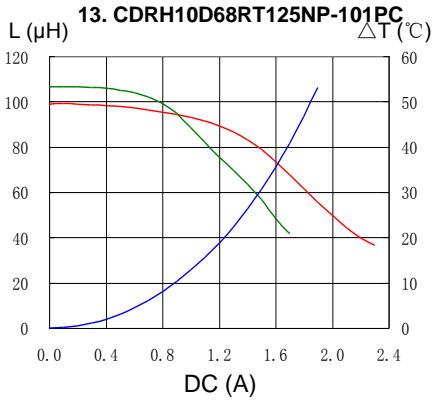

SMD Power Inductor CDRH10D68R/T125



Solder Reflow Condition

Heat Endurance

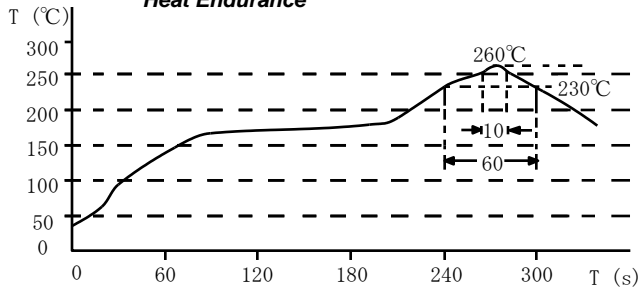

Temperature Chart

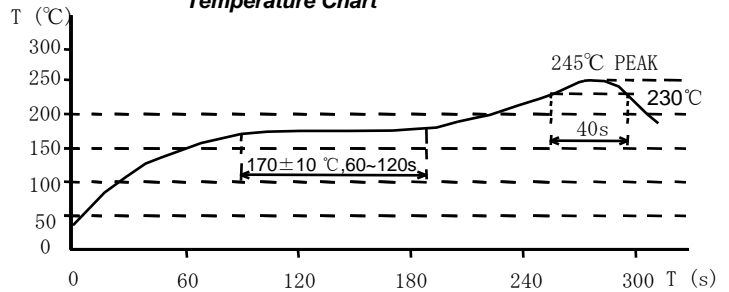

Please refer to the sales offices on our website - <http://www.sumida.com>

Hong Kong

Tel.+852-2880-6781
FAX.+852-2565-9600
sales@hk.sumida.com

Saitama(Japan)

Tel.+81-48-691-7300
FAX.+81-48-691-7340
sales@jp.sumida.com

Chicago

Tel.+1-847-545-6700
FAX. +1-847-545-6720
sales@us.sumida.com

Shanghai

Tel.+86-21-5836-3299
FAX.+86-21-5836-3266
shanghai.sales@cn.sumida.com

Seoul

Tel.+82-2-6237-0777
FAX.+82-2-6237-0778
sales@kr.sumida.com

Obernzell

Tel.+49-8591-937-0
FAX. +49-8591-937-103
contact@eu.sumida.com

Shenzhen

Tel.+86-755-8291-0228
FAX.+86-755-8291-0338
shenzhen.sales@cn.sumida.com

Singapore

Tel.+65-6296-3388
FAX.+65-6841-4426
sales@sg.sumida.com

Neumarkt

Tel.+49-9181-4509-110
FAX. +49-9181-4509-310
infocomp@eu.sumida.com

Taipei

Tel.+886-2-8751-2737
FAX.+886-2-8751-2738
sales@tw.sumida.com

San Jose

Tel.+1-408-321-9660
FAX.+1-408-321-9308
sales@us.sumida.com

X-ON Electronics

Largest Supplier of Electrical and Electronic Components

Click to view similar products for [Fixed Inductors](#) category:

Click to view products by [Sumida](#) manufacturer:

Other Similar products are found below :

[CR32NP-151KC](#) [CR32NP-180KC](#) [CR32NP-181KC](#) [CR32NP-1R5MC](#) [CR32NP-390KC](#) [CR32NP-3R9MC](#) [CR32NP-680KC](#) [CR32NP-820KC](#) [CR32NP-8R2MC](#) [CR43NP-390KC](#) [CR43NP-560KC](#) [CR43NP-680KC](#) [CR54NP-181KC](#) [CR54NP-470LC](#) [CR54NP-820KC](#) [CR54NP-8R5MC](#) [70F224AI](#) [MGDQ4-00004-P](#) [MHL1ECTTP18NJ](#) [MHQ1005P10NJ](#) [MHQ1005P1N0S](#) [MHQ1005P2N4S](#) [MHQ1005P3N6S](#) [MHQ1005P5N1S](#) [MHQ1005P8N2J](#) [PE-51506NL](#) [PE-53601NL](#) [PE-53602NL](#) [PE-53630NL](#) [PE-53824SNLT](#) [PE-92100NL](#) [PG0434.801NLT](#) [PG0936.113NLT](#) [9220-20](#) [9310-16](#) [PM06-2N7](#) [PM06-39NJ](#) [A01TK](#) [1206CS-471XJ](#) [HC2LP-R47-R](#) [HC2-R47-R](#) [HC3-2R2-R](#) [HCF1305-3R3-R](#) [1206CS-151XG](#) [RCH664NP-140L](#) [RCH664NP-4R7M](#) [RCH8011NP-221L](#) [RCP1317NP-332L](#) [RCP1317NP-391L](#) [RCR1010NP-470M](#)