

SMD Power Inductor CDRH124

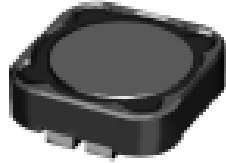

Description

- Ferrite drum core construction.
- Magnetically shielded.
- L × W × H: 12.3 × 12.3 × 4.5 mm Max.
- Product weight: 2.3g(Ref.)
- Moisture Sensitivity Level: 1
- RoHS compliance.

Environmental Data

- Operating temperature range: -40°C ~ +100°C (including coil's self temperature rise)
- Storage temperature range: -40°C ~ +100°C
- Solder reflow temperature: 260 °C peak.

Packaging

- Carrier tape and reel packaging
- 13" diameter reel
- 500pcs per reel

Applications

- Ideally used in Notebook PC, LCD TV, DVD, Game machine, STB, Projector etc as DC-DC converter inductors.

Dimension - [mm]

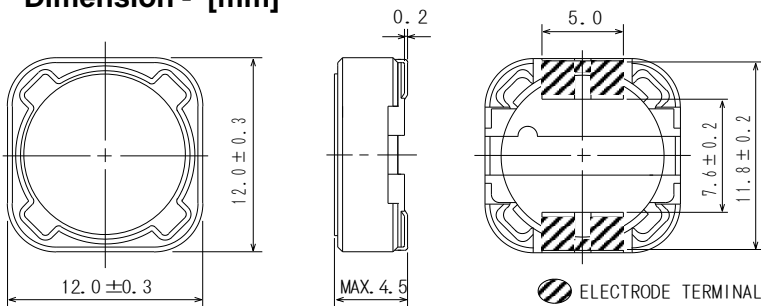

Land pattern and Schematics - [mm]

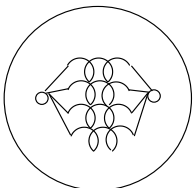
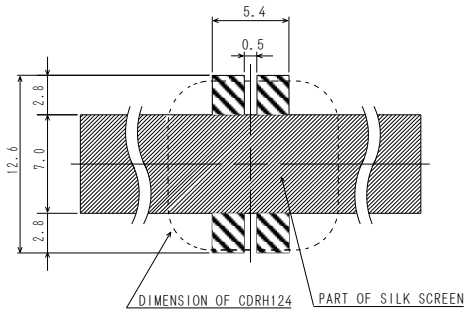

3.9µH~10µH

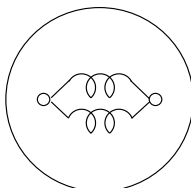

12µH~47µH,
68µH,82µH

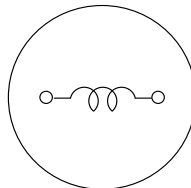

56µH,
100µH~330µH



Electrical Characteristics

PART NO.	STAMP	INDUCTANCE [WITHIN] ※1	D.C.R. (mΩ) (at 20°C) MAX.(TYP.)	SATURATION CURRENT (A)※2 MAX.(TYP.)	TEMPERATURE RISE CURRENT (A)※3
CDRH124NP-3R9MC	3R9	3.9μH ± 20%	15(12)	8.60(10.80)	7.30
CDRH124NP-4R7MC	4R7	4.7μH ± 20%	18(14)	7.75(9.70)	6.60
CDRH124NP-6R8MC	6R8	6.8μH ± 20%	23(18)	6.40(8.00)	5.90
CDRH124NP-8R2MC	8R2	8.2μH ± 20%	26(21)	6.32(7.90)	5.40
CDRH124NP-100MC	100	10 μH ± 20%	28(22)	5.60(7.00)	5.05
CDRH124NP-120MC	120	12 μH ± 20%	38(30)	4.96(6.20)	4.55
CDRH124NP-150MC	150	15 μH ± 20%	50(40)	4.32(5.40)	3.80
CDRH124NP-180MC	180	18 μH ± 20%	57(46)	3.96(4.95)	3.72
CDRH124NP-220MC	220	22 μH ± 20%	66(53)	3.80(4.75)	3.52
CDRH124NP-270MC	270	27 μH ± 20%	80(64)	3.08(3.85)	3.30
CDRH124NP-330MC	330	33 μH ± 20%	97(78)	2.96(3.70)	3.10
CDRH124NP-390MC	390	39 μH ± 20%	132(106)	2.66(3.32)	2.55
CDRH124NP-470MC	470	47 μH ± 20%	150(120)	2.56(3.20)	2.28
CDRH124NP-560MC	560	56 μH ± 20%	190(152)	2.36(2.95)	2.10
CDRH124NP-680MC	680	68 μH ± 20%	220(176)	2.14(2.67)	1.80
CDRH124NP-820MC	820	82 μH ± 20%	260(208)	1.90(2.37)	1.55
CDRH124NP-101MC	101	100μH ± 20%	308(246)	1.66(2.07)	1.40
CDRH124NP-121MC	121	120μH ± 20%	380(304)	1.52(1.90)	1.32
CDRH124NP-151MC	151	150μH ± 20%	530(424)	1.42(1.77)	1.20
CDRH124NP-181MC	181	180μH ± 20%	620(496)	1.33(1.66)	1.06
CDRH124NP-221MC	221	220μH ± 20%	700(560)	1.18(1.48)	0.93
CDRH124NP-271MC	271	270μH ± 20%	870(696)	0.98(1.23)	0.76
CDRH124NP-331MC	331	330μH ± 20%	990(792)	0.90(1.13)	0.65

※1 Measured frequency L at 100 kHz

※2 Saturation current: This indicates the value of D.C. current when the inductance becomes 25% lower than it's initial value. (Ta=20°C).

※3 Temperature rise current :The actual value of D.C. current when the temperature of coil becomes $\Delta T=40^{\circ}\text{C}$ (Ta=20°C).

SMD Power Inductor CDRH124



Saturation Current & Temperature Rise Graph

— L (20°C) — L (100°C) — ΔT

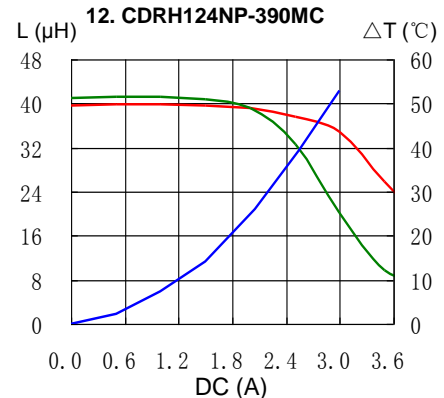
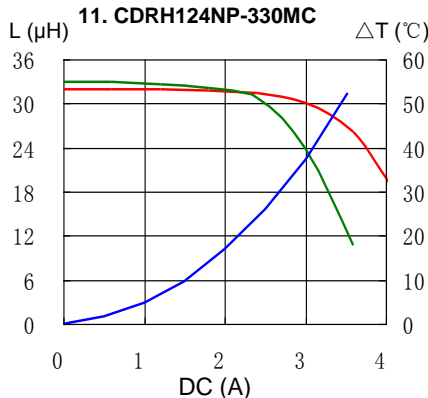
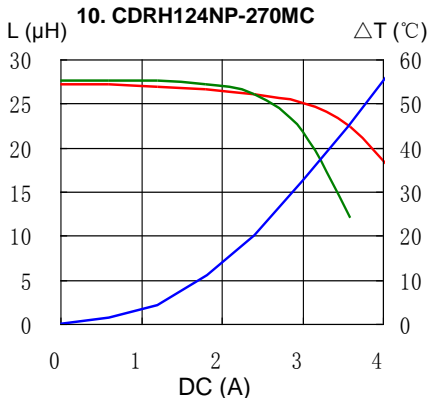
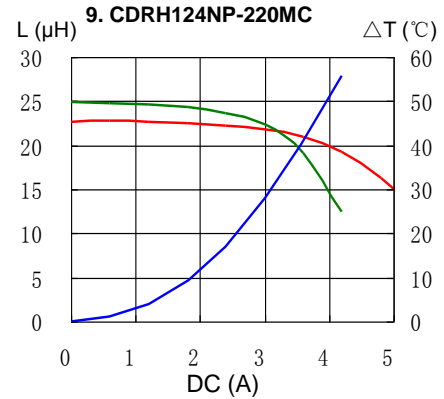
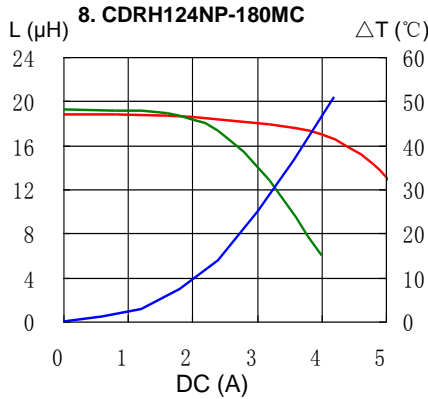
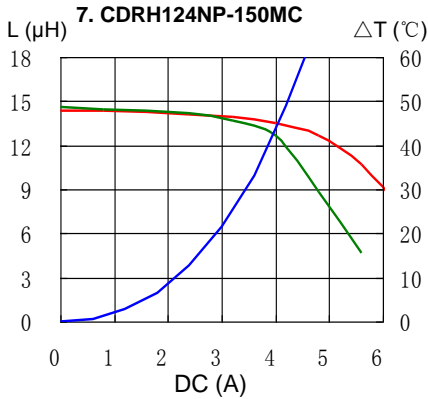
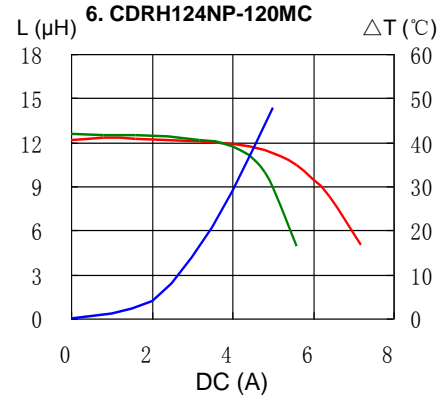
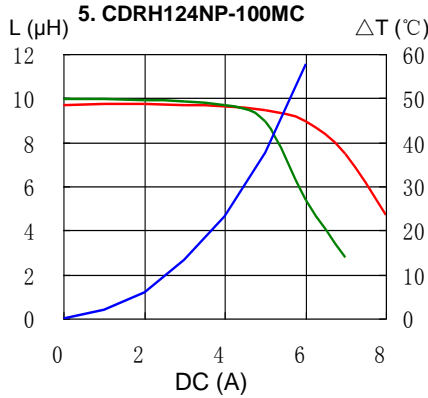
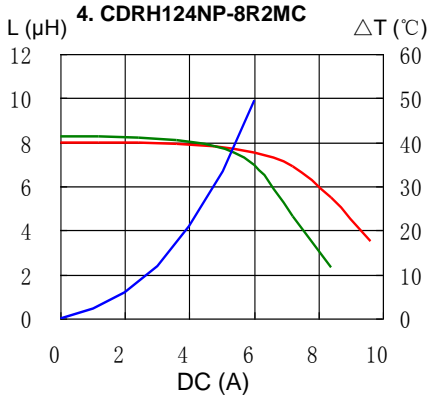
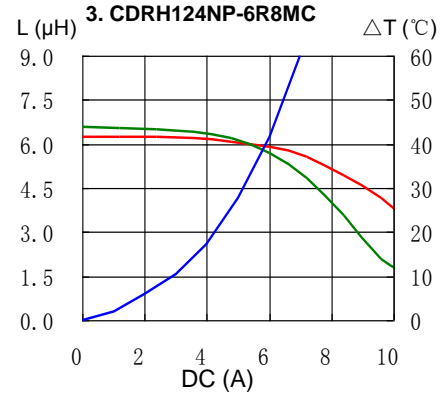
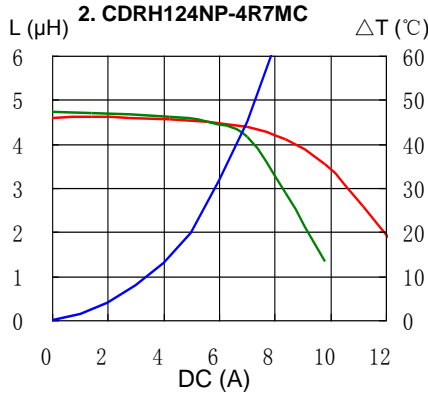
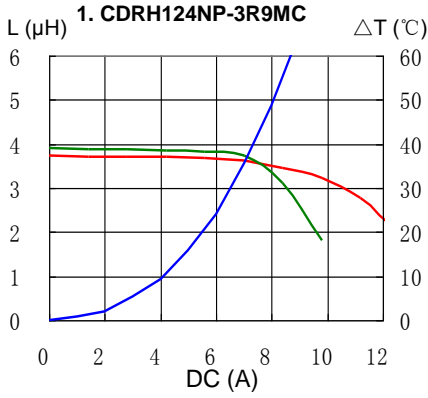

SMD Power Inductor CDRH124



Saturation Current & Temperature Rise Graph

— L (20°C) — L (100°C) — ΔT

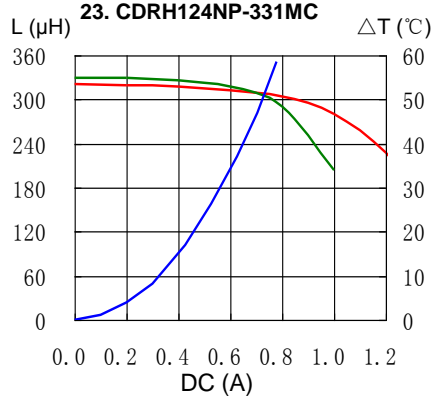
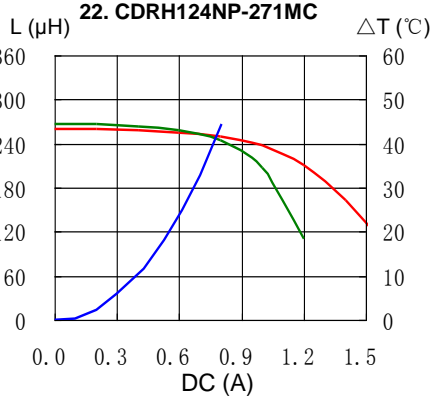
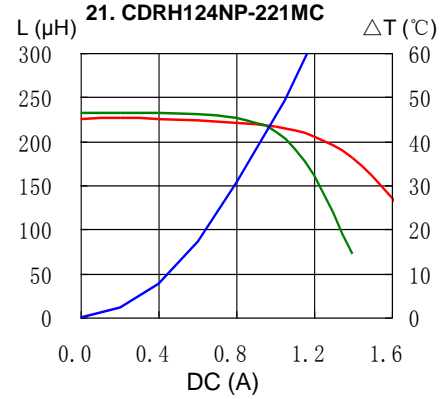
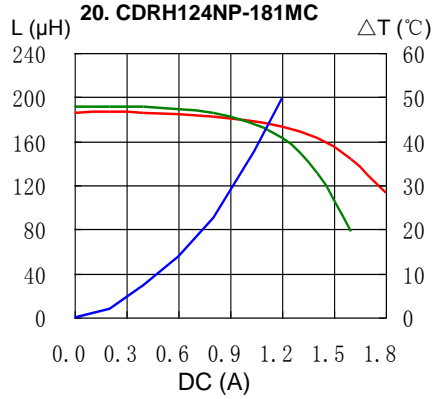
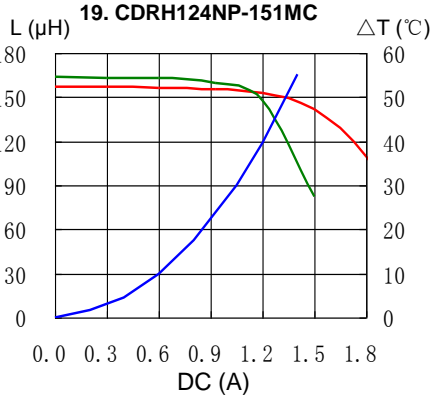
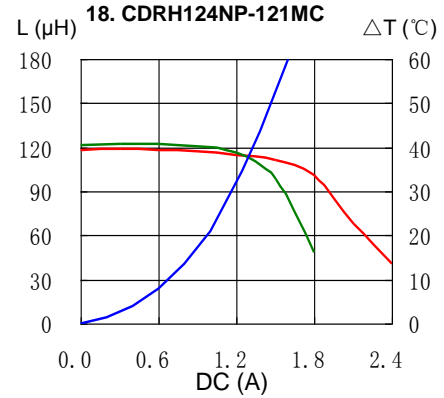
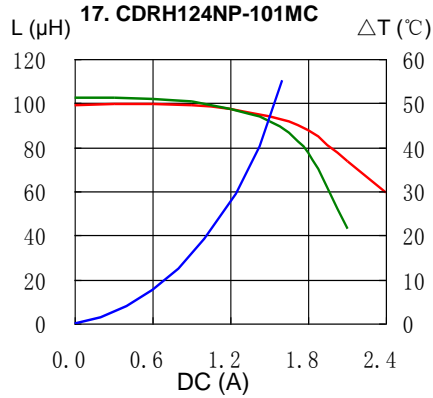
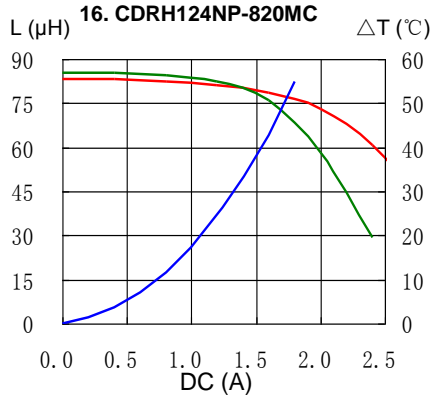
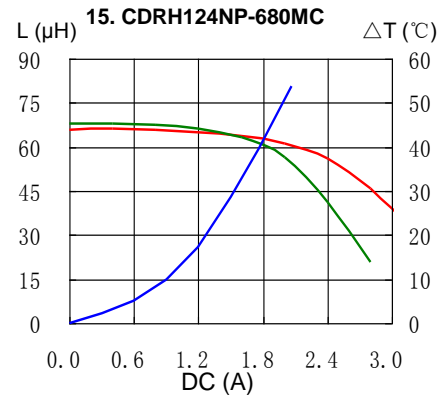
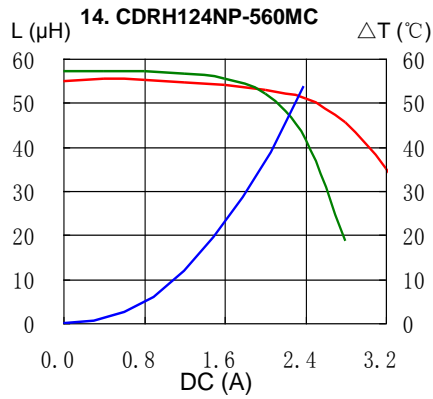
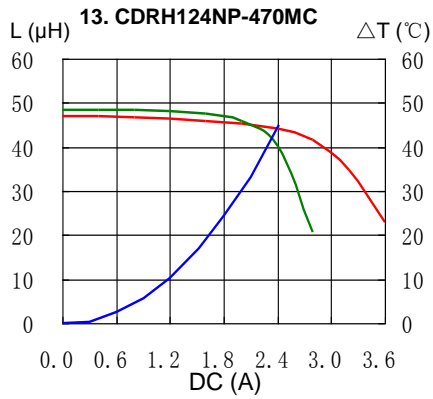

SMD Power Inductor CDRH124

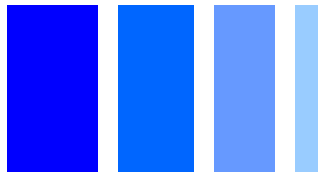

Solder Reflow Condition

Heat Endurance



Temperature Chart



Please refer to the sales offices on our website - <http://www.sumida.com>

Hong Kong

Tel.+852-2880-6781
FAX.+852-2565-9600
sales@hk.sumida.com

Saitama(Japan)

Tel.+81-48-691-7300
FAX.+81-48-691-7340
sales@jp.sumida.com

Chicago

Tel.+1-847-545-6700
FAX. +1-847-545-6720
sales@us.sumida.com

Shanghai

Tel.+86-21-5836-3299
FAX.+86-21-5836-3266
shanghai.sales@cn.sumida.com

Seoul

Tel.+82-2-6237-0777
FAX.+82-2-6237-0778
sales@kr.sumida.com

Obernzell

Tel.+49-8591-937-0
FAX. +49-8591-937-103
contact@eu.sumida.com

Shenzhen

Tel.+86-755-8291-0228
FAX.+86-755-8291-0338
shenzhen.sales@cn.sumida.com

Singapore

Tel.+65-6296-3388
FAX.+65-6841-4426
sales@sg.sumida.com

Neumarkt

Tel.+49-9181-4509-110
FAX. +49-9181-4509-310
infocomp@eu.sumida.com

Taipei

Tel.+886-2-8751-2737
FAX.+886-2-8751-2738
sales@tw.sumida.com

San Jose

Tel.+1-408-321-9660
FAX.+1-408-321-9308
sales@us.sumida.com

X-ON Electronics

Largest Supplier of Electrical and Electronic Components

Click to view similar products for [Fixed Inductors](#) category:

Click to view products by [Sumida](#) manufacturer:

Other Similar products are found below :

[CR43NP-680KC](#) [CR54NP-820KC](#) [CR54NP-8R5MC](#) [CTX32CT-100](#) [70F224AI](#) [MGDQ4-00004-P](#) [MHL1ECTTP18NJ](#) [MHL1JCTTD12NJ](#)
[PE-51506NL](#) [PE-53601NL](#) [PE-53602NL](#) [PE-53630NL](#) [PE-53824SNLT](#) [PE-62892NL](#) [PE-92100NL](#) [PG0434.801NLT](#) [PG0936.113NLT](#)
[9310-16](#) [PM06-2N7](#) [PM06-39NJ](#) [A01TK](#) [1206CS-471XJ](#) [HC2-2R2TR](#) [HC2LP-R47-R](#) [HC3-2R2-R](#) [1206CS-151XG](#) [RCH664NP-140L](#)
[RCH664NP-4R7M](#) [RCH8011NP-221L](#) [RCP1317NP-332L](#) [RCP1317NP-391L](#) [RCR1010NP-470M](#) [RCR110DNP-331L](#) [DH2280-4R7M](#)
[DS1608C-106](#) [ASPI-4020HI-R10M-T](#) [B10TJ](#) [B82477P4333M](#) [B82498B3101J000](#) [B82498B3680J000](#) [ELJ-RE27NJF2](#) [1812CS-153XJ](#)
[1812CS-183XJ](#) [1812CS-223XJ](#) [1812LS-104XJ](#) [1812LS-105XJ](#) [1812LS-124XJ](#) [1812LS-154XJ](#) [1812LS-223XJ](#) [1812LS-224XJ](#)