

# SMD Power Inductor CDRH125/LD

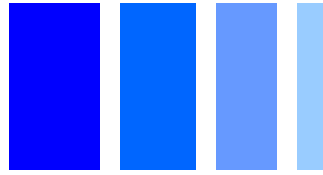

## Description

- Ferrite drum core construction.
- Magnetically shielded.
- L × W × H: 12.3 × 12.3 × 6.0 mm Max.
- Product weight: 2.9g(Ref.)
- Moisture Sensitivity Level: 1
- RoHS compliance.

## Environmental Data

- Operating temperature range: -40°C ~ +100°C (including coil's self temperature rise)
- Storage temperature range: -40°C ~ +100°C
- Solder reflow temperature: 260 °C peak.

## Packaging

- Carrier tape and reel packaging
- 13" diameter reel
- 500pcs per reel

## Applications

- Ideally used in Notebook PC, LCD TV, DVD, Game machine, STB, Projector etc. as converter inductors.

## Dimension - [mm]

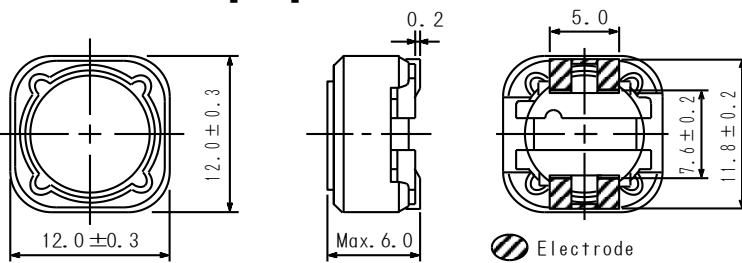

## Land pattern and Schematics - [mm]

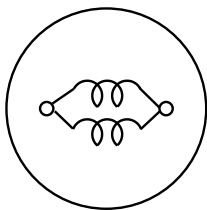
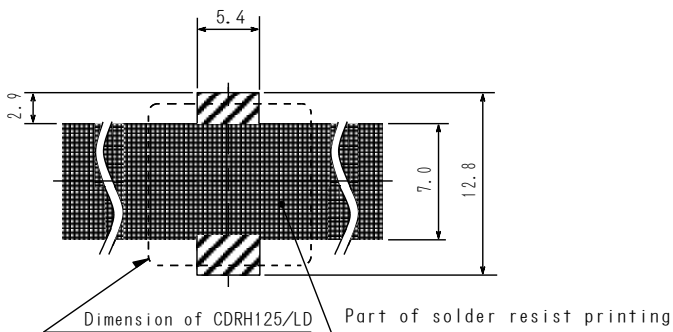

7.5µH ~ 56µH

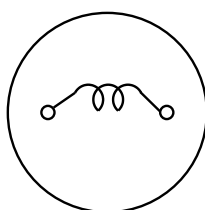

68µH ~ 1000µH

※2 Saturation current: This indicates the value of D.C. current when the inductance becomes 25% lower than its initial value. (Ta=20°C)  
 ※3 Temperature rise current: The actual value of D.C. current when the temperature of coil becomes  $\Delta T=40^{\circ}\text{C}$  (Ta=20°C).

# SMD Power Inductor

## CDRH125/LD

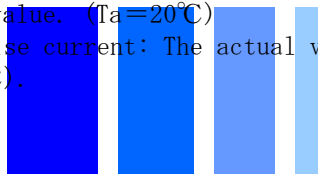

### Electrical Characteristics

Part No	Stamp	Inductance [Within] ※1	D.C.R ( $\Omega$ ) [Typ.]	D.C.R ( $\Omega$ ) [Max.]	Saturation current (A)※2 Max.(Typ.)	Temperature rise current (A)※3
CDRH125/LDNP-7R5NC	7R5	7.5 $\mu\text{H} \pm 30\%$	14.7m	19.0m	5.60(7.00)	6.40
CDRH125/LDNP-100NC	100	10 $\mu\text{H} \pm 30\%$	22.5m	29.0m	4.60(6.00)	5.40
CDRH125/LDNP-120MC	120	12 $\mu\text{H} \pm 20\%$	24.6m	32.0m	4.20(5.40)	5.20
CDRH125/LDNP-150MC	150	15 $\mu\text{H} \pm 20\%$	27.1m	35.0m	4.00(5.00)	5.00
CDRH125/LDNP-180MC	180	18 $\mu\text{H} \pm 20\%$	31.8m	41.0m	3.56(4.50)	4.60
CDRH125/LDNP-220MC	220	22 $\mu\text{H} \pm 20\%$	33.9m	44.0m	3.28(4.20)	4.50
CDRH125/LDNP-270MC	270	27 $\mu\text{H} \pm 20\%$	41.5m	52.0m	3.00(3.70)	4.20
CDRH125/LDNP-330MC	330	33 $\mu\text{H} \pm 20\%$	50.0m	65.0m	2.60(3.25)	3.80
CDRH125/LDNP-390MC	390	39 $\mu\text{H} \pm 20\%$	60.0m	75.0m	2.40 (3.00)	3.40
CDRH125/LDNP-470MC	470	47 $\mu\text{H} \pm 20\%$	72.5m	95.0m	2.30(2.90)	2.70
CDRH125/LDNP-560MC	560	56 $\mu\text{H} \pm 20\%$	95.4m	125m	2.00(2.50)	2.60
CDRH125/LDNP-680MC	680	68 $\mu\text{H} \pm 20\%$	0.110	0.140	1.85(2.25)	2.40
CDRH125/LDNP-820MC	820	82 $\mu\text{H} \pm 20\%$	0.121	0.157	1.70(2.10)	2.30
CDRH125/LDNP-101MC	101	100 $\mu\text{H} \pm 20\%$	0.144	0.187	1.60(2.00)	2.15
CDRH125/LDNP-121MC	121	120 $\mu\text{H} \pm 20\%$	0.175	0.228	1.37(1.70)	1.90
CDRH125/LDNP-151MC	151	150 $\mu\text{H} \pm 20\%$	0.218	0.280	1.26(1.60)	1.75
CDRH125/LDNP-181MC	181	180 $\mu\text{H} \pm 20\%$	0.259	0.335	1.14(1.45)	1.48
CDRH125/LDNP-221MC	221	220 $\mu\text{H} \pm 20\%$	0.303	0.395	1.08(1.35)	1.40
CDRH125/LDNP-271MC	271	270 $\mu\text{H} \pm 20\%$	0.403	0.520	0.94 (1.20)	1.25
CDRH125/LDNP-331MC	331	330 $\mu\text{H} \pm 20\%$	0.547	0.710	0.85 (1.10)	1.05
CDRH125/LDNP-391MC	391	390 $\mu\text{H} \pm 20\%$	0.614	0.800	0.77 (0.98)	1.00
CDRH125/LDNP-471MC	471	470 $\mu\text{H} \pm 20\%$	0.711	0.920	0.72 (0.90)	0.95
CDRH125/LDNP-561MC	561	560 $\mu\text{H} \pm 20\%$	0.956	1.20	0.67 (0.83)	0.85
CDRH125/LDNP-681MC	681	680 $\mu\text{H} \pm 20\%$	1.08	1.35	0.57 (0.71)	1.78
CDRH125/LDNP-821MC	821	820 $\mu\text{H} \pm 20\%$	1.17	1.40	0.51 (0.62)	1.72
CDRH125/LDNP-102MC	102	1000 $\mu\text{H} \pm 20\%$	1.62	1.95	0.46 (0.58)	0.60

※1 Measured frequency (Inductance  $\leq 10\mu\text{H}$  at 7.96MHz; Inductance  $> 10\mu\text{H}$  at 100kHz)

※2 Saturation current: This indicates the value of D.C. current when the inductance becomes 25% lower than its initial value. (Ta=20°C)

※3 Temperature rise current: The actual value of D.C. current when the temperature of coil becomes  $\Delta T=40^{\circ}\text{C}$  (Ta=20°C).

# SMD Power Inductor CDRH125/LD



## Saturation Current & Temperature Rise Graph

— L (20°C)    —  $\Delta T$

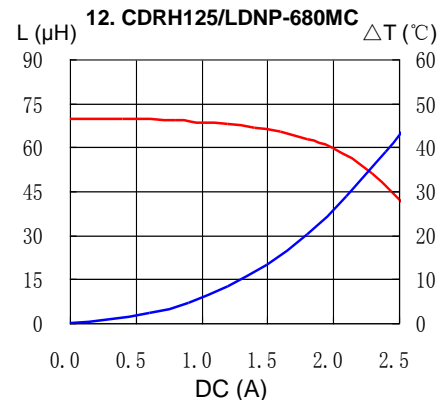
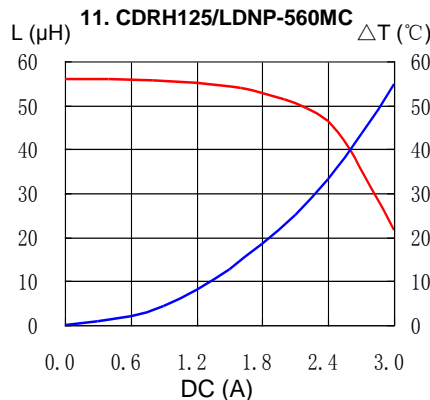
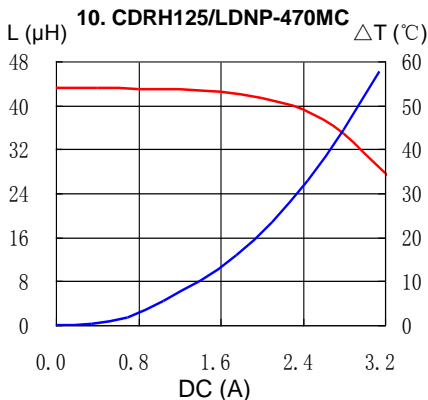
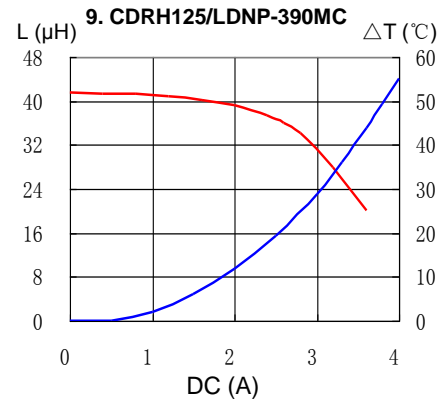
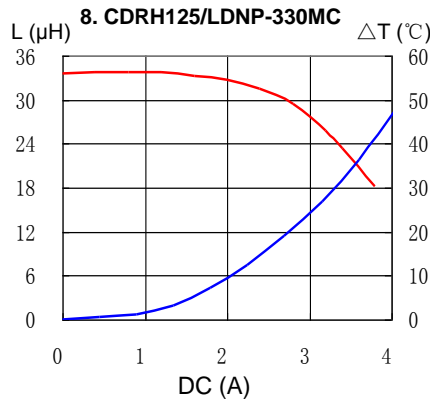
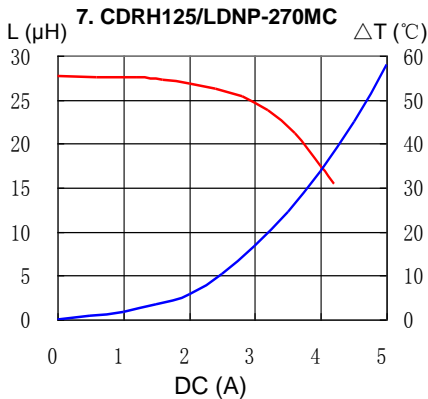
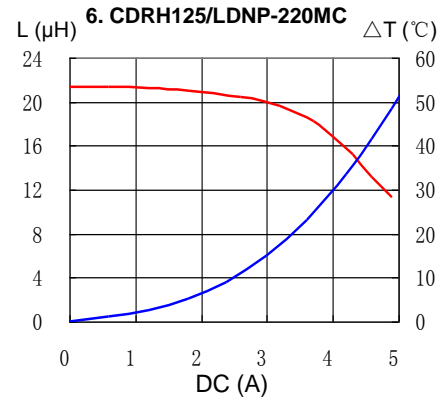
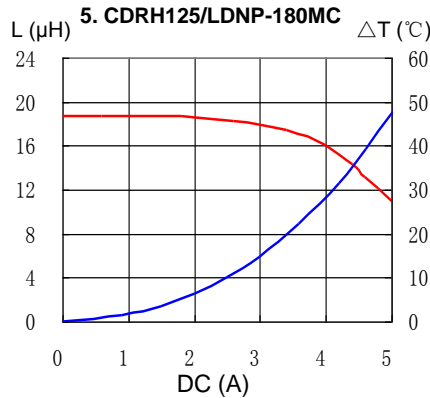
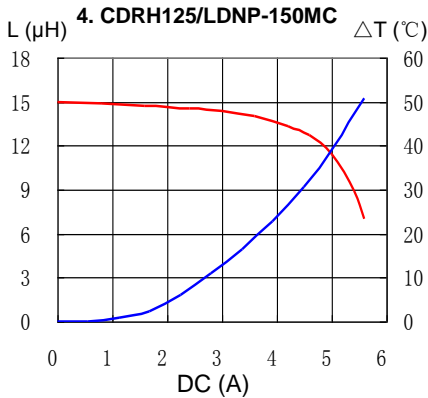
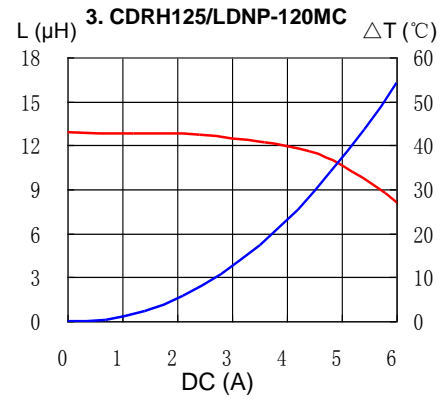
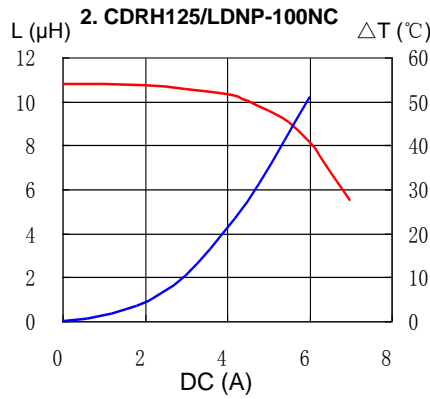
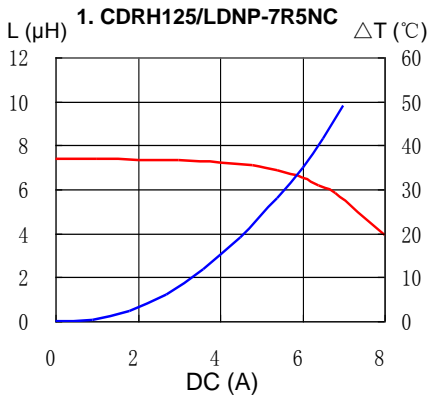

# SMD Power Inductor CDRH125/LD

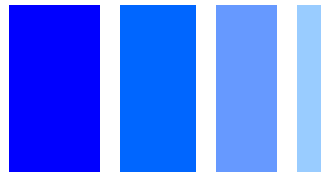

## Saturation Current & Temperature Rise Graph

— L (20°C)    —  $\Delta T$

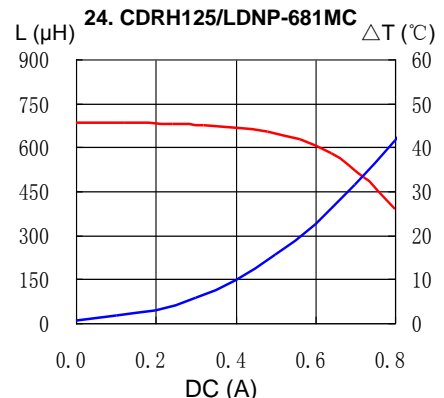
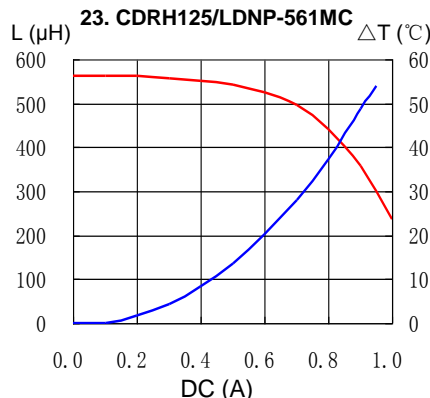
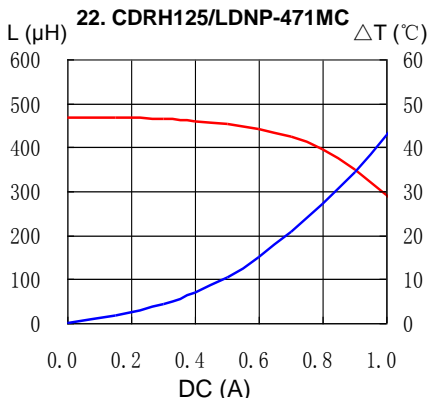
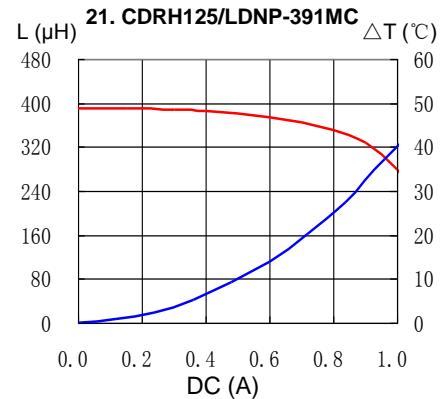
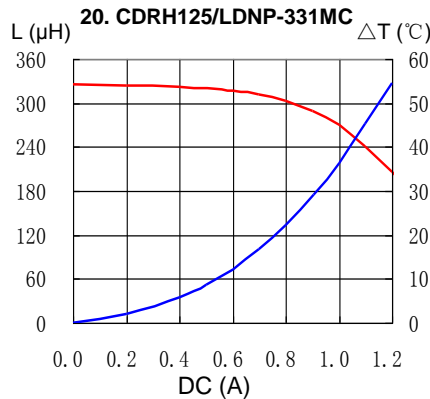
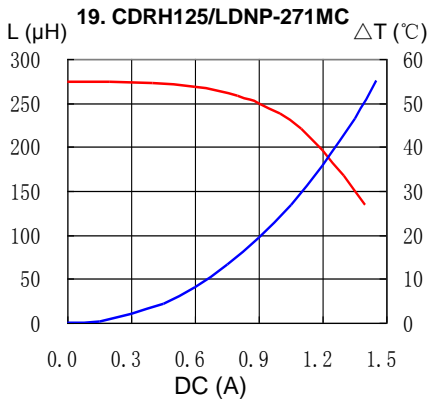
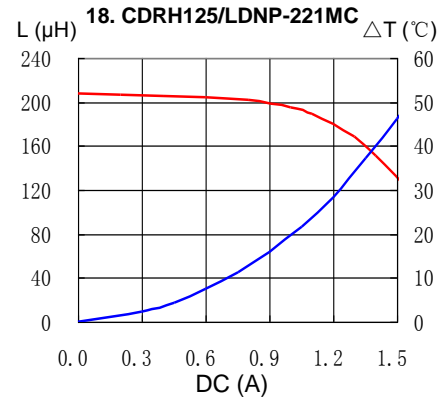
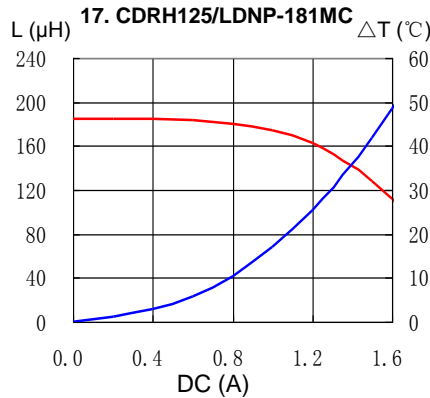
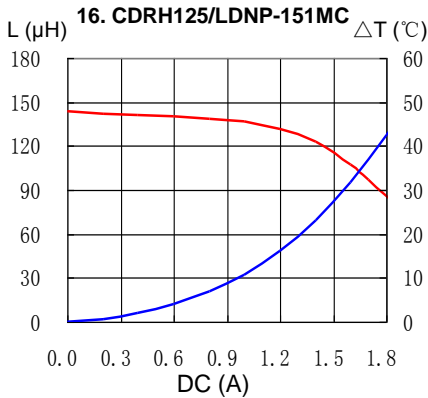
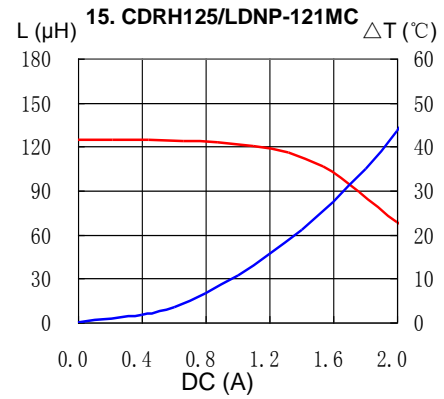
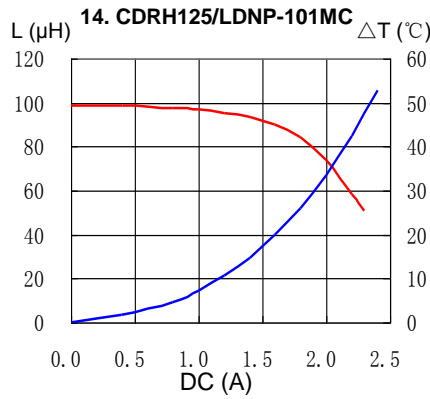
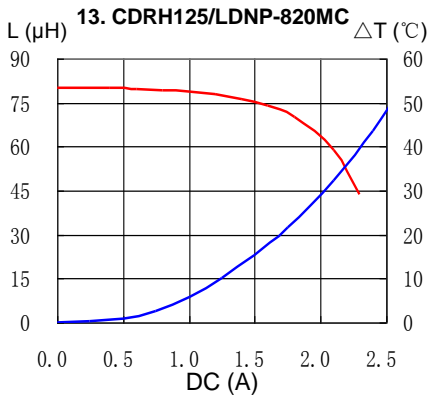

# SMD Power Inductor CDRH125/LD

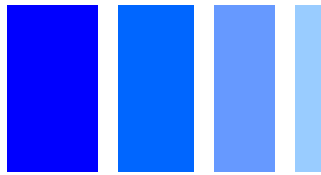

## Saturation Current & Temperature Rise Graph

— L (20°C)    —  $\Delta T$

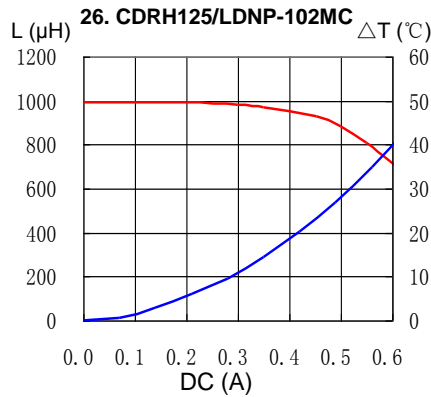
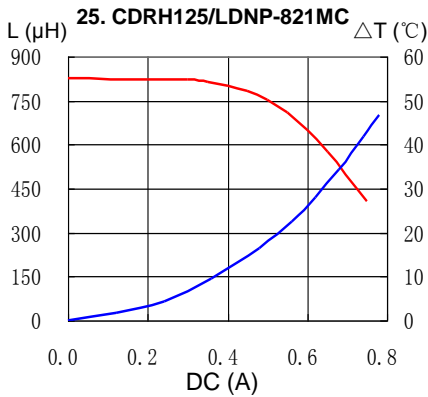

## Solder Reflow Condition

**Heat Endurance**

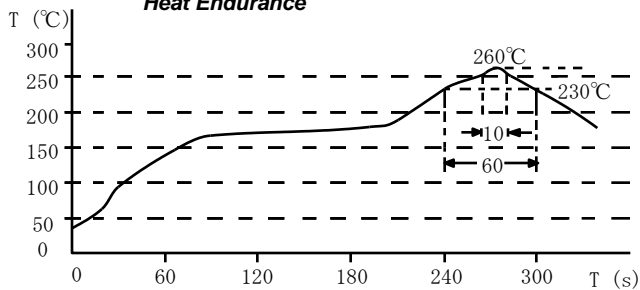

**Temperature Chart**

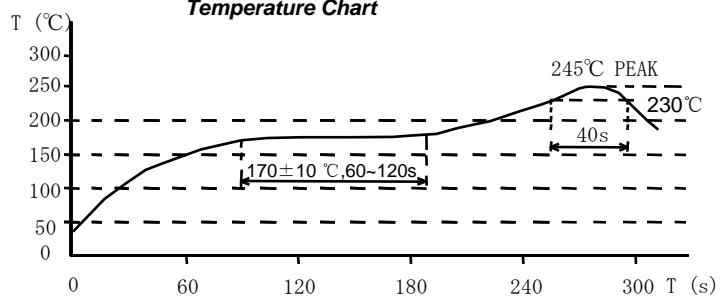

Please refer to the sales offices on our website - <http://www.sumida.com>

### Hong Kong

Tel. +852-2880-6781  
FAX. +852-2565-9600  
[sales@hk.sumida.com](mailto:sales@hk.sumida.com)

### Saitama(Japan)

Tel. +81-48-691-7300  
FAX. +81-48-691-7340  
[sales@jp.sumida.com](mailto:sales@jp.sumida.com)

### Chicago

Tel. +1-847-545-6700  
FAX. +1-847-545-6720  
[sales@us.sumida.com](mailto:sales@us.sumida.com)

### Shanghai

Tel. +86-21-5836-3299  
FAX. +86-21-5836-3266  
[shanghai.sales@cn.sumida.com](mailto:shanghai.sales@cn.sumida.com)

### Seoul

Tel. +82-2-6237-0777  
FAX. +82-2-6237-0778  
[sales@kr.sumida.com](mailto:sales@kr.sumida.com)

### Obernzell

Tel. +49-8591-937-0  
FAX. +49-8591-937-103  
[contact@eu.sumida.com](mailto:contact@eu.sumida.com)

### Shenzhen

Tel. +86-755-8291-0228  
FAX. +86-755-8291-0338  
[shenzhen.sales@cn.sumida.com](mailto:shenzhen.sales@cn.sumida.com)

### Singapore

Tel. +65-6296-3388  
FAX. +65-6841-4426  
[sales@sg.sumida.com](mailto:sales@sg.sumida.com)

### Neumarkt

Tel. +49-9181-4509-110  
FAX. +49-9181-4509-310  
[infocomp@eu.sumida.com](mailto:infocomp@eu.sumida.com)

### Taipei

Tel. +886-2-8751-2737  
FAX. +886-2-8751-2738  
[sales@tw.sumida.com](mailto:sales@tw.sumida.com)

### San Jose

Tel. +1-408-321-9660  
FAX. +1-408-321-9308  
[sales@us.sumida.com](mailto:sales@us.sumida.com)

## X-ON Electronics

Largest Supplier of Electrical and Electronic Components

*Click to view similar products for [Fixed Inductors](#) category:*

*Click to view products by [Sumida](#) manufacturer:*

Other Similar products are found below :

[CR43NP-680KC](#) [CR54NP-820KC](#) [CR54NP-8R5MC](#) [CTX32CT-100](#) [70F224AI](#) [MGDQ4-00004-P](#) [MHL1ECTTP18NJ](#) [MHL1JCTTD12NJ](#)  
[PE-51506NL](#) [PE-53601NL](#) [PE-53602NL](#) [PE-53630NL](#) [PE-53824SNLT](#) [PE-92100NL](#) [PG0434.801NLT](#) [PG0936.113NLT](#) [9310-16](#) [PM06-2N7](#) [PM06-39NJ](#) [A01TK](#) [1206CS-471XJ](#) [HC2-2R2TR](#) [HC2LP-R47-R](#) [HC3-2R2-R](#) [1206CS-151XG](#) [RCH664NP-140L](#) [RCH664NP-4R7M](#)  
[RCH8011NP-221L](#) [RCP1317NP-332L](#) [RCP1317NP-391L](#) [RCR1010NP-470M](#) [RCR110DNP-331L](#) [DH2280-4R7M](#) [DS1608C-106](#) [ASPI-4020HI-R10M-T](#) [B10TJ](#) [B82477P4333M](#) [B82498B3101J000](#) [B82498B3680J000](#) [ELJ-RE27NJF2](#) [1812CS-153XJ](#) [1812CS-183XJ](#) [1812CS-223XJ](#) [1812LS-104XJ](#) [1812LS-105XJ](#) [1812LS-124XJ](#) [1812LS-154XJ](#) [1812LS-223XJ](#) [1812LS-224XJ](#) [1812LS-563XJ](#)