

SMD Power Inductor CDRH129R



Description

- Ferrite drum core construction.
- Magnetically shielded.
- L × W × H: 12.4 × 12.4 × 10.0 mm Max.
- Product weight: 5.3g(Ref.)
- Moisture Sensitivity Level: 1
- RoHS compliance.

Environmental Data

- Operating temperature range: -40°C ~ +105°C (including coil's self temperature rise)
- Storage temperature range: -40°C ~ +105°C
- Solder reflow temperature: 260 °C peak.

Packaging

- Carrier tape and reel packaging.
- 13" diameter reel.
- 250pcs per reel.

Applications

- Ideally used in LED lighting, etc.

Dimension - [mm]

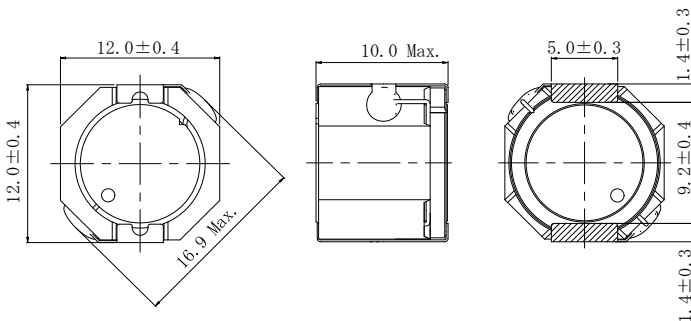

Land pattern and Schematics - [mm]

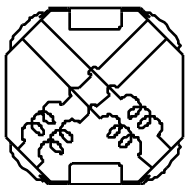
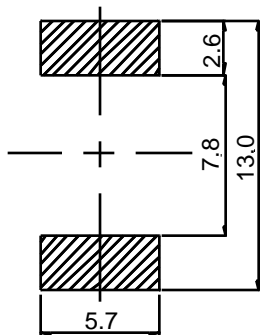

10µH~56µH

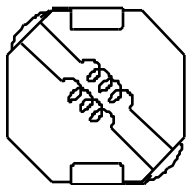

68µH~330µH

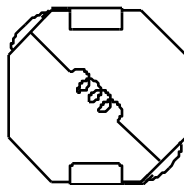

470µH~1.0mH



Electrical Characteristics

Part No.	Stamp	Inductance (μH) ※1 [Within]	D.C.R.(mΩ) [Max] (typ.) (at 20°C)	Saturation current (A) (at20°C)※2	Temperature rise current (A) ※3
CDRH129RNP-100MC	100	10±20%	16.5(13.2)	7.60	6.50
CDRH129RNP-150MC	150	15±20%	20.3(16.2)	5.80	6.00
CDRH129RNP-220MC	220	22±20%	32.9(26.3)	5.30	4.70
CDRH129RNP-330MC	330	33±20%	39.3(31.4)	4.00	4.25
CDRH129RNP-470MC	470	47±20%	53.4(42.7)	3.45	3.80
CDRH129RNP-560MC	560	56±20%	67.0(53.6)	3.15	3.25
CDRH129RNP-680MC	680	68±20%	83.5(66.8)	2.95	2.85
CDRH129RNP-820MC	820	82±20%	90.6(72.5)	2.60	2.75
CDRH129RNP-101MC	101	100±20%	116(93)	2.40	2.45
CDRH129RNP-151MC	151	150±20%	159(127)	1.95	2.20
CDRH129RNP-221MC	221	220±20%	226(181)	1.60	1.85
CDRH129RNP-331MC	331	330±20%	366(293)	1.30	1.45
CDRH129RNP-471MC	471	470±20%	415(330)	1.08	1.30
CDRH129RNP-561MC	561	560±20%	521(417)	1.00	1.18
CDRH129RNP-681MC	681	680±20%	654(523)	0.91	1.04
CDRH129RNP-821MC	821	820±20%	825(660)	0.82	0.92
CDRH129RNP-102MC	102	1000±20%	938(750)	0.75	0.82

※1 Measuring condition: at 100kHz.

※2 The saturation current: This indicates the value of DC current when the inductance decreases to 75% of its nominal.

※3 The temperature rise: The value of DC current when the temperature rise is $\Delta T=40^{\circ}\text{C}$ ($T_a=20^{\circ}\text{C}$).

SMD Power Inductor CDRH129R



Saturation Current & Temperature Rise Graph

— L (20°C) — L (105°C) — ΔT

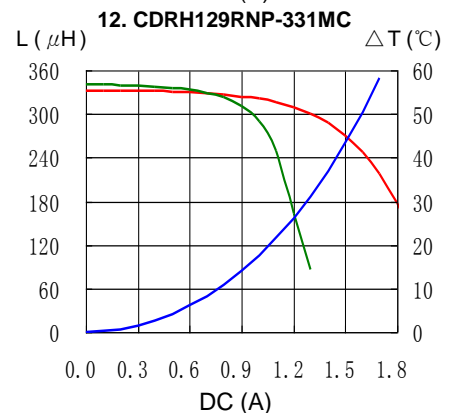
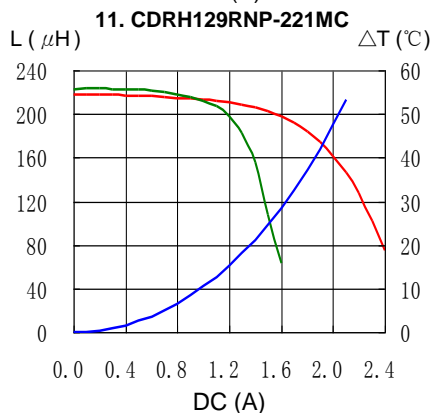
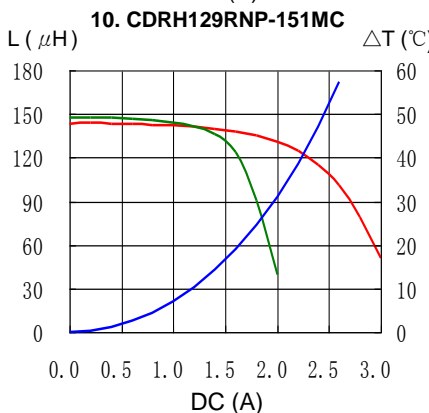
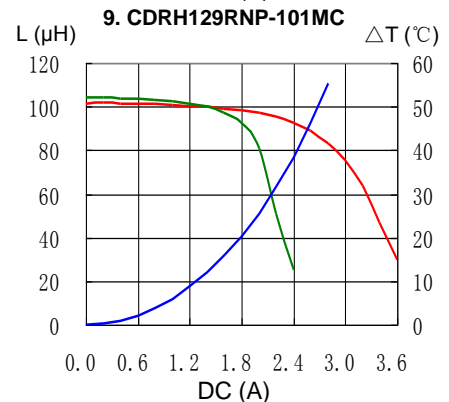
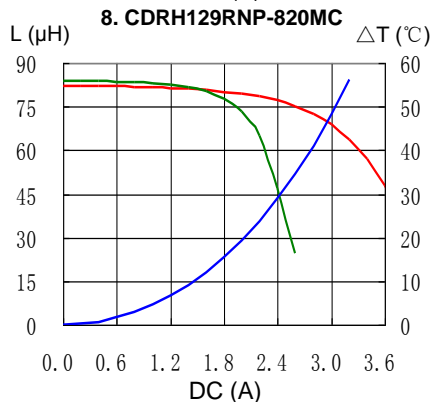
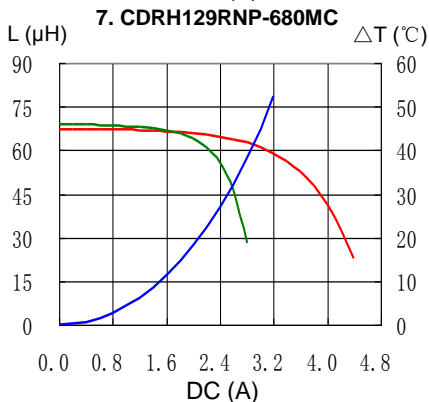
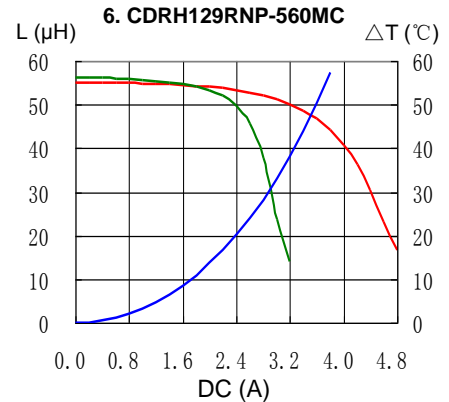
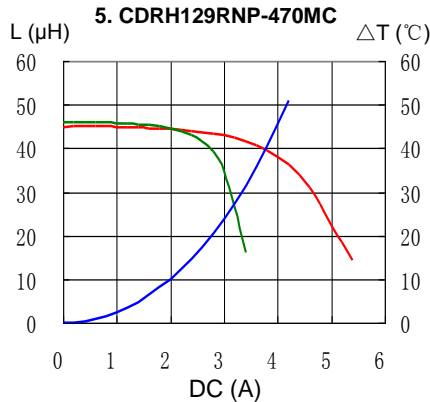
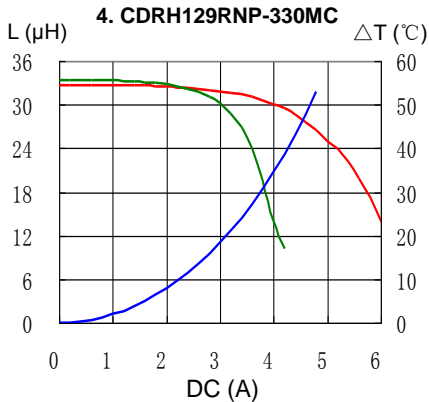
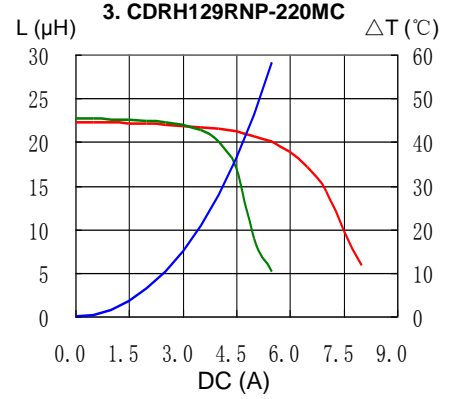
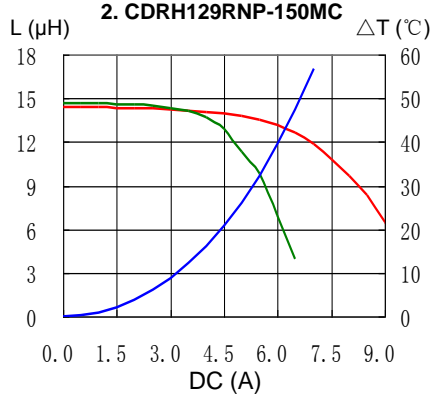
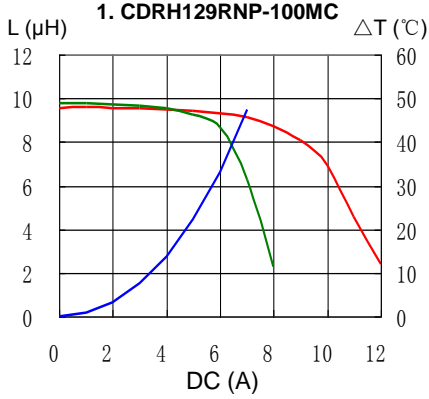

SMD Power Inductor CDRH129R

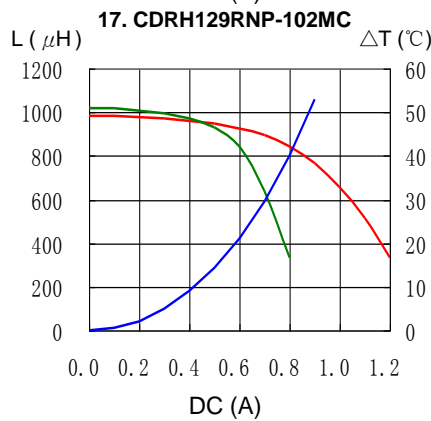
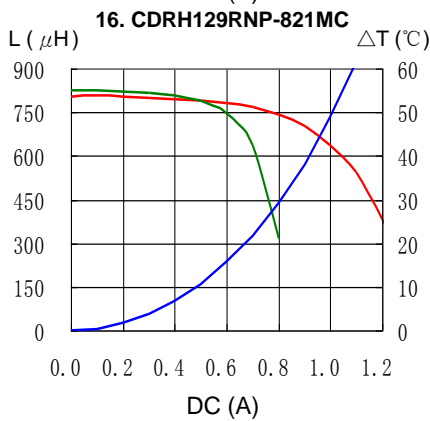
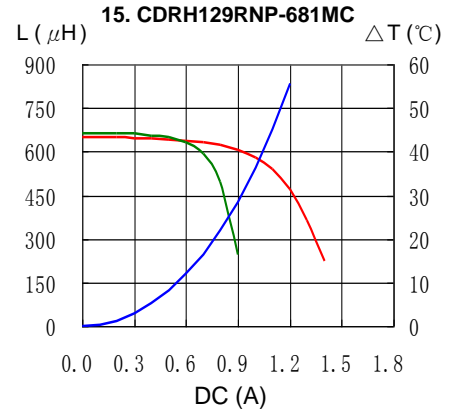
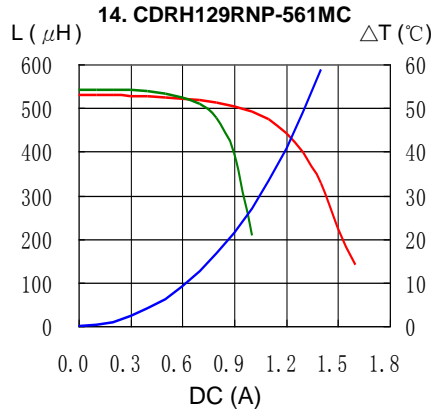
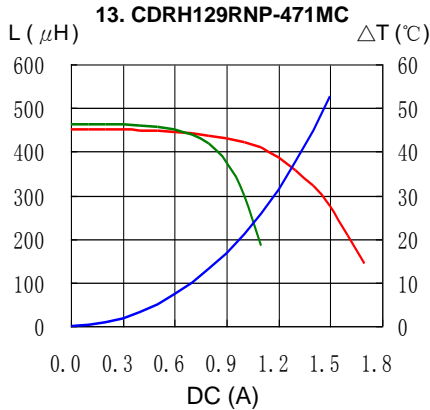
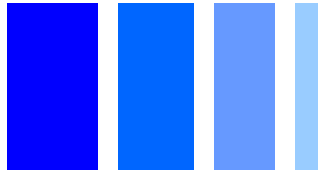

Solder Reflow Condition

Heat Endurance

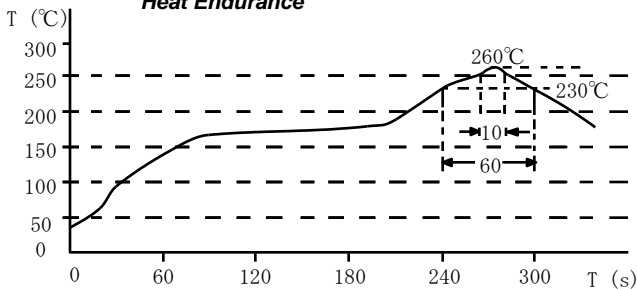

Temperature Chart

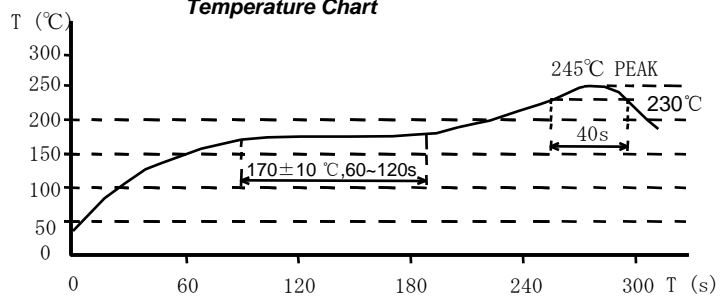

Please refer to the sales offices on our website - <http://www.sumida.com>

Hong Kong

Tel.+852-2880-6781
FAX.+852-2565-9600
sales@hk.sumida.com

Saitama(Japan)

Tel.+81-48-691-7300
FAX.+81-48-691-7340
sales@jp.sumida.com

Chicago

Tel.+1-847-545-6700
FAX. +1-847-545-6720
sales@us.sumida.com

Shanghai

Tel.+86-21-5836-3299
FAX.+86-21-5836-3266
shanghai.sales@cn.sumida.com

Seoul

Tel.+82-2-6237-0777
FAX.+82-2-6237-0778
sales@kr.sumida.com

Obernzell

Tel.+49-8591-937-0
FAX. +49-8591-937-103
contact@eu.sumida.com

Shenzhen

Tel.+86-755-8291-0228
FAX.+86-755-8291-0338
shenzhen.sales@cn.sumida.com

Singapore

Tel.+65-6296-3388
FAX.+65-6841-4426
sales@sg.sumida.com

Neumarkt

Tel.+49-9181-4509-110
FAX. +49-9181-4509-310
infocomp@eu.sumida.com

Taipei

Tel.+886-2-8751-2737
FAX.+886-2-8751-2738
sales@tw.sumida.com

San Jose

Tel.+1-408-321-9660
FAX.+1-408-321-9308
sales@us.sumida.com

X-ON Electronics

Largest Supplier of Electrical and Electronic Components

Click to view similar products for [Fixed Inductors](#) category:

Click to view products by [Sumida](#) manufacturer:

Other Similar products are found below :

[CR32NP-100KC](#) [CR32NP-151KC](#) [CR32NP-180KC](#) [CR32NP-181KC](#) [CR32NP-1R5MC](#) [CR32NP-390KC](#) [CR32NP-3R9MC](#) [CR32NP-680KC](#) [CR32NP-820KC](#) [CR32NP-8R2MC](#) [CR43NP-390KC](#) [CR43NP-560KC](#) [CR43NP-680KC](#) [CR54NP-181KC](#) [CR54NP-470LC](#) [CR54NP-820KC](#) [CR54NP-8R5MC](#) [70F224AI](#) [MGDQ4-00004-P](#) [MHL1ECTTP18NJ](#) [MHQ1005P10NJ](#) [MHQ1005P1N0S](#) [MHQ1005P2N4S](#) [MHQ1005P3N6S](#) [MHQ1005P5N1S](#) [MHQ1005P8N2J](#) [PE-51506NL](#) [PE-53601NL](#) [PE-53602NL](#) [PE-53630NL](#) [PE-53824SNLT](#) [PE-92100NL](#) [PG0434.801NLT](#) [PG0936.113NLT](#) [9220-20](#) [9310-16](#) [PM06-2N7](#) [PM06-39NJ](#) [A01TK](#) [1206CS-471XJ](#) [HC2LP-R47-R](#) [HC2-R47-R](#) [HC3-2R2-R](#) [HCF1305-3R3-R](#) [1206CS-151XG](#) [RCH664NP-140L](#) [RCH664NP-4R7M](#) [RCH8011NP-221L](#) [RCP1317NP-332L](#) [RCP1317NP-391L](#)