

# SMD Power Inductor CDRH12D78/A

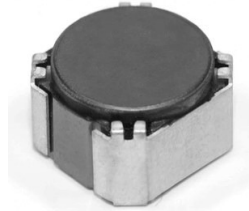

## Description

- Ferrite drum core construction.
- Magnetically shielded.
- L × W × H: 12.5 × 12.5 × 8.0 mm Max.
- Product weight 4.1g(Ref.)
- Moisture Sensitivity Level: 1
- RoHS compliance.
- Qualification to AEC-Q200.

## Environmental Data

- Operating temperature range: -40°C ~ +125°C (including coil's self temperature rise)
- Storage temperature range: -40°C ~ +85°C
- Solder reflow temperature: 260 °C peak.

## Packaging

- Carrier tape and reel packaging.
- 13.0" diameter reel
- 500pcs per reel

## Applications

- Automotive and other high temperature, high reliability application.

## Dimension - [mm]

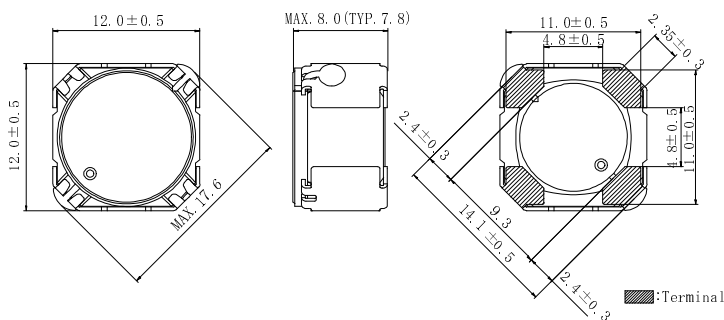

## Land pattern and Schematics - [mm]

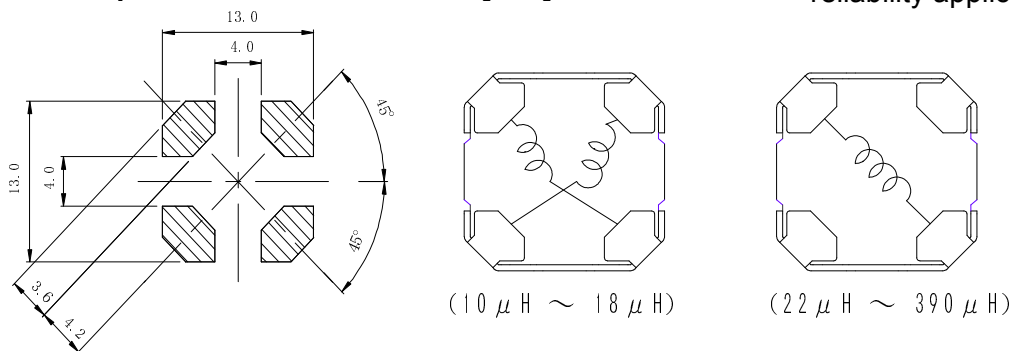

# SMD Power Inductor

## CDRH12D78/A



### Electrical Characteristics

Part name	Stamp	Inductance ( $\mu$ H) [within] ※1	D.C.R. (m $\Omega$ ) [Max.].(Typ.) (at 20°C)	Rated current (A) (at 125°C) ※2
CDRH12D78/ANP-100MC	100M	10 $\mu$ H $\pm$ 20%	22(17)	4.2
CDRH12D78/ANP-120MC	120M	12 $\mu$ H $\pm$ 20%	24(19)	4.0
CDRH12D78/ANP-150MC	150M	15 $\mu$ H $\pm$ 20%	27(21)	3.7
CDRH12D78/ANP-180MC	180M	18 $\mu$ H $\pm$ 20%	29(23)	3.4
CDRH12D78/ANP-220MC	220M	22 $\mu$ H $\pm$ 20%	44(35)	2.9
CDRH12D78/ANP-270MC	270M	27 $\mu$ H $\pm$ 20%	47(37)	2.7
CDRH12D78/ANP-330MC	330M	33 $\mu$ H $\pm$ 20%	64(51)	2.4
CDRH12D78/ANP-390MC	390M	39 $\mu$ H $\pm$ 20%	68(54)	2.3
CDRH12D78/ANP-470MC	470M	47 $\mu$ H $\pm$ 20%	75(60)	2.1
CDRH12D78/ANP-560MC	560M	56 $\mu$ H $\pm$ 20%	84(67)	1.9
CDRH12D78/ANP-680MC	680M	68 $\mu$ H $\pm$ 20%	97(77)	1.7
CDRH12D78/ANP-820MC	820M	82 $\mu$ H $\pm$ 20%	124(99)	1.6
CDRH12D78/ANP-101MC	101M	100 $\mu$ H $\pm$ 20%	152(121)	1.4
CDRH12D78/ANP-121MC	121M	120 $\mu$ H $\pm$ 20%	197(157)	1.3
CDRH12D78/ANP-151MC	151M	150 $\mu$ H $\pm$ 20%	249(199)	1.2
CDRH12D78/ANP-181MC	181M	180 $\mu$ H $\pm$ 20%	270(216)	1.1
CDRH12D78/ANP-221MC	221M	220 $\mu$ H $\pm$ 20%	308(246)	1.0
CDRH12D78/ANP-271MC	271M	270 $\mu$ H $\pm$ 20%	448(358)	0.86
CDRH12D78/ANP-331MC	331M	330 $\mu$ H $\pm$ 20%	579(463)	0.75
CDRH12D78/ANP-391MC	391M	390 $\mu$ H $\pm$ 20%	730(584)	0.66

※1. Measuring condition: at 100 kHz.

※2. Rated current: The DC current at which the inductance decreases to 65% of its nominal value or when  $\Delta t=30^{\circ}\text{C}$ , whichever is lower .

# SMD Power Inductor CDRH12D78/A

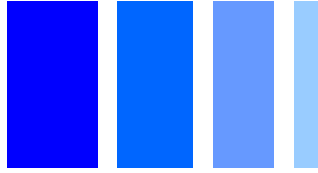

## Saturation Current & Temperature Rise Graph

— L (20°C) — L (125°C) —  $\Delta T$

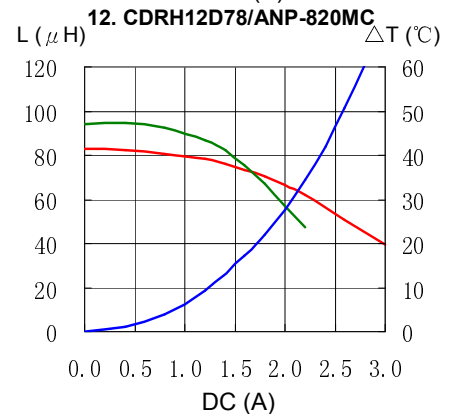
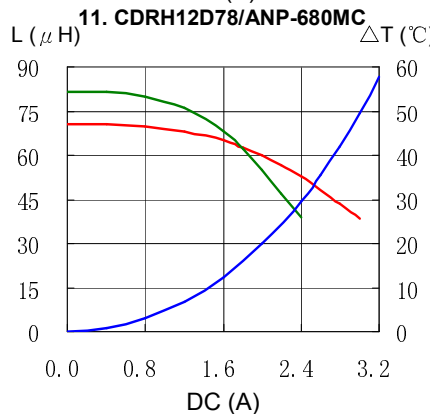
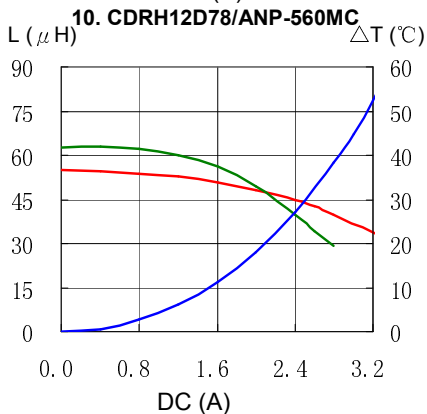
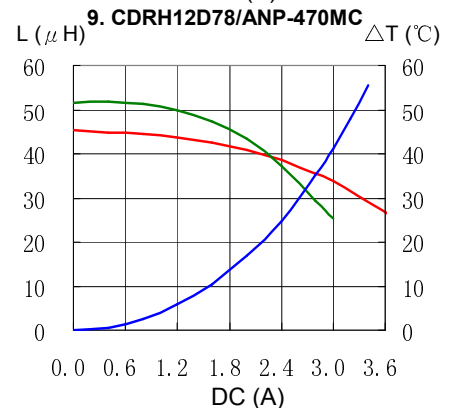
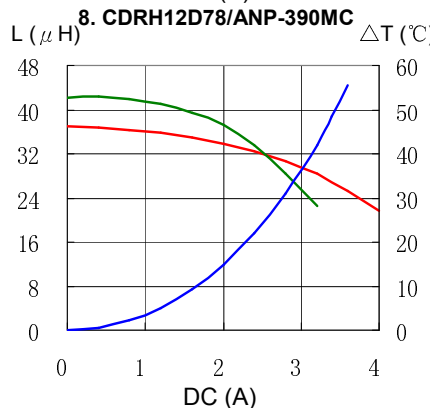
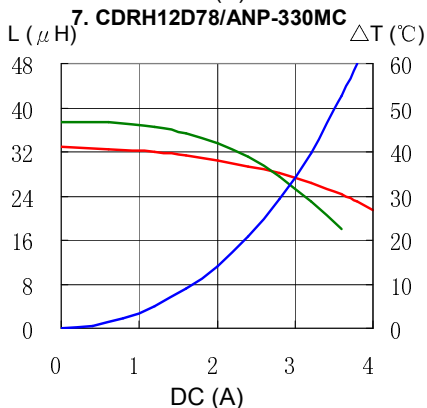
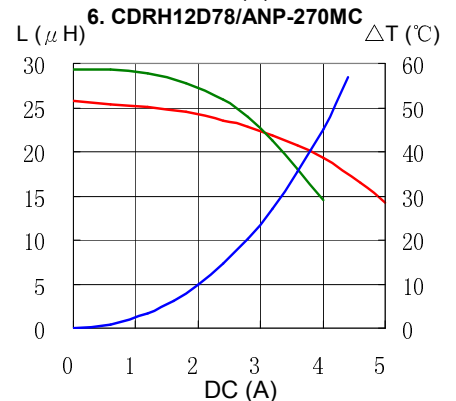
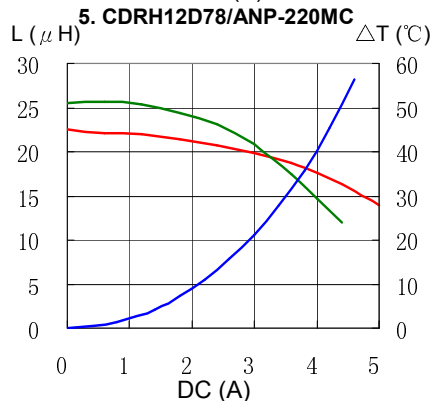
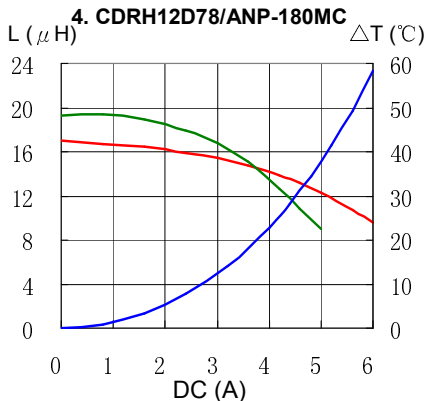
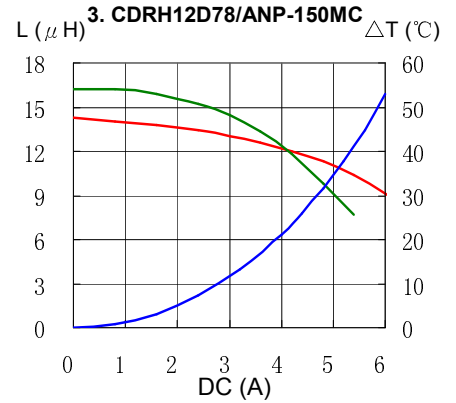
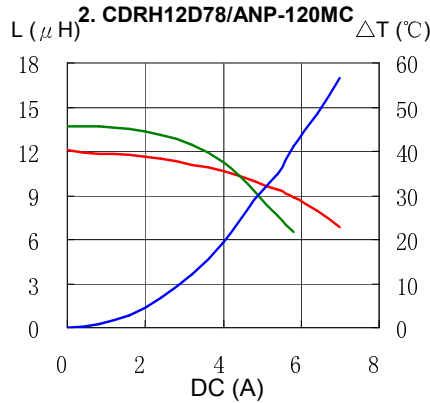
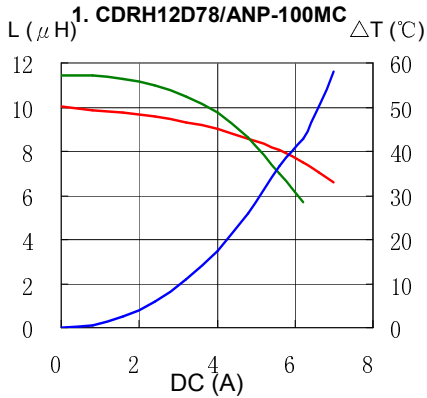

# SMD Power Inductor CDRH12D78/A



## Saturation Current & Temperature Rise Graph

— L (20°C) — L (125°C) —  $\Delta T$

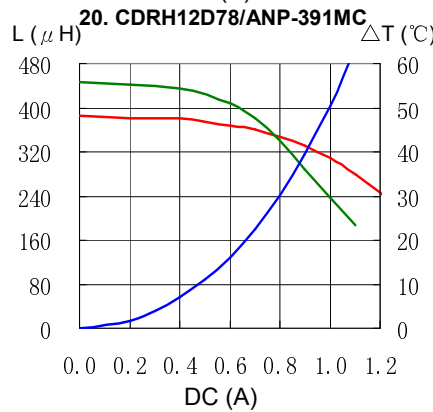
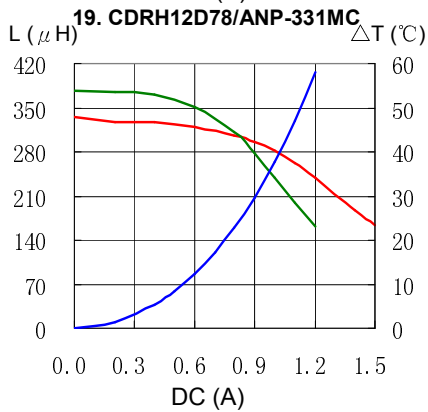
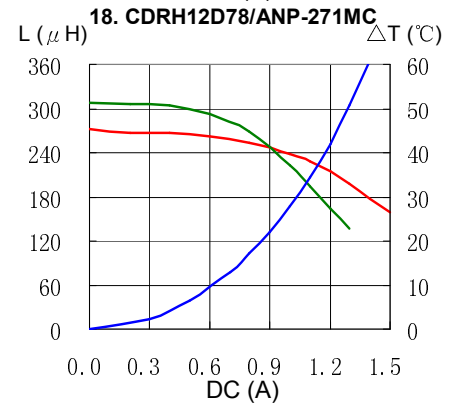
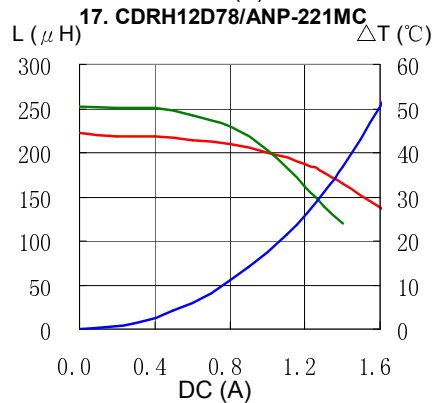
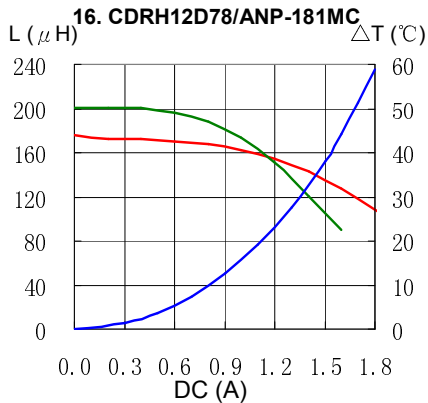
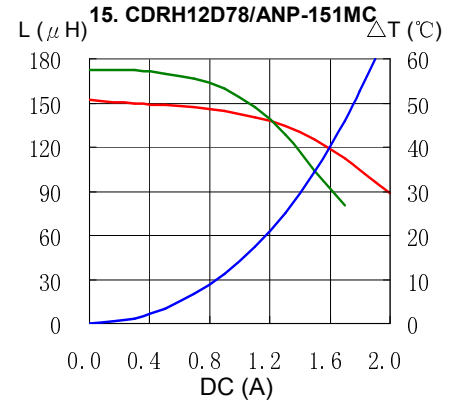
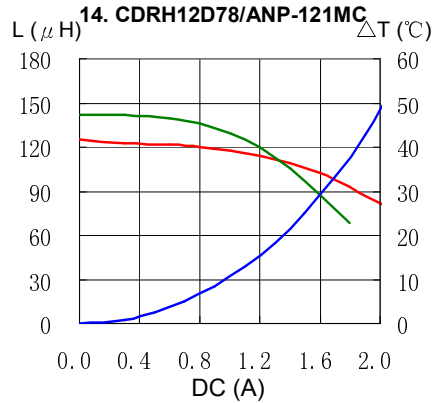
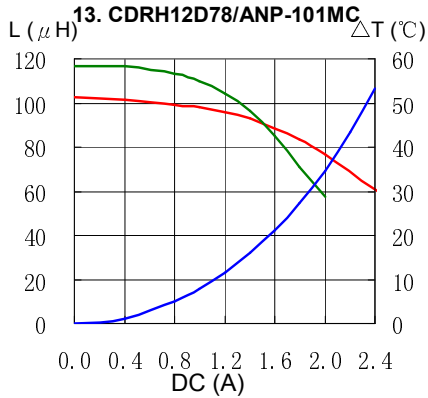

# SMD Power Inductor CDRH12D78/A



## Solder Reflow Condition

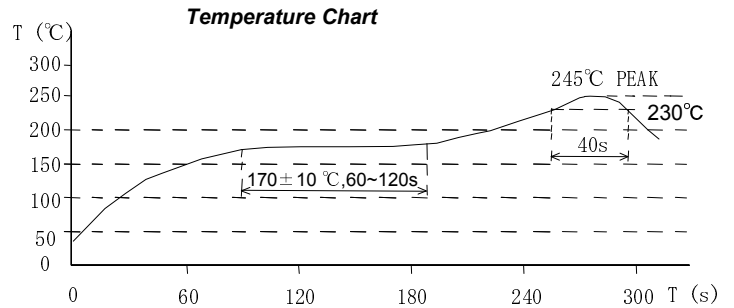
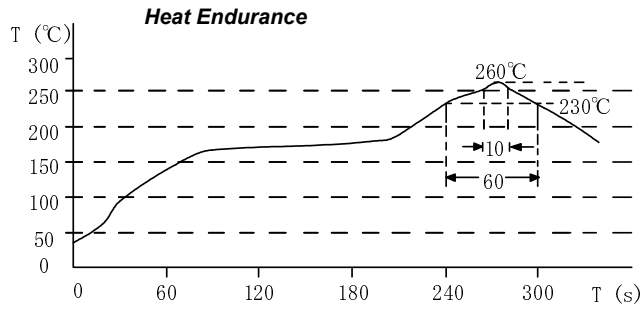

Please refer to the sales offices on our website - <http://www.sumida.com>

### Hong Kong

Tel.+852-2880-6781  
FAX.+852-2565-9600  
[sales@hk.sumida.com](mailto:sales@hk.sumida.com)

### Saitama(Japan)

Tel.+81-48-691-7300  
FAX.+81-48-691-7340  
[sales@jp.sumida.com](mailto:sales@jp.sumida.com)

### Chicago

Tel.+1-847-545-6700  
FAX. +1-847-545-6720  
[sales@us.sumida.com](mailto:sales@us.sumida.com)

### Shanghai

Tel.+86-21-5836-3299  
FAX.+86-21-5836-3266  
[shanghai.sales@cn.sumida.com](mailto:shanghai.sales@cn.sumida.com)

### Seoul

Tel.+82-2-6237-0777  
FAX.+82-2-6237-0778  
[sales@kr.sumida.com](mailto:sales@kr.sumida.com)

### Oberzell

Tel.+49-8591-937-0  
FAX. +49-8591-937-103  
[contact@eu.sumida.com](mailto:contact@eu.sumida.com)

### Shenzhen

Tel.+86-755-8291-0228  
FAX.+86-755-8291-0338  
[shenzhen.sales@cn.sumida.com](mailto:shenzhen.sales@cn.sumida.com)

### Singapore

Tel.+65-6296-3388  
FAX.+65-6841-4426  
[sales@sg.sumida.com](mailto:sales@sg.sumida.com)

### Neumarkt

Tel.+49-9181-4509-110  
FAX. +49-9181-4509-310  
[infocomp@eu.sumida.com](mailto:infocomp@eu.sumida.com)

### Taipei

Tel.+886-2-8751-2737  
FAX.+886-2-8751-2738  
[sales@tw.sumida.com](mailto:sales@tw.sumida.com)

### San Jose

Tel.+1-408-321-9660  
FAX.+1-408-321-9308  
[sales@us.sumida.com](mailto:sales@us.sumida.com)

## X-ON Electronics

Largest Supplier of Electrical and Electronic Components

*Click to view similar products for [Fixed Inductors](#) category:*

*Click to view products by [Sumida](#) manufacturer:*

Other Similar products are found below :

[CR43NP-680KC](#) [CR54NP-820KC](#) [CR54NP-8R5MC](#) [CTX32CT-100](#) [70F224AI](#) [MGDQ4-00004-P](#) [MHL1ECTTP18NJ](#) [MHL1JCTTD12NJ](#)  
[PE-51506NL](#) [PE-53601NL](#) [PE-53602NL](#) [PE-53630NL](#) [PE-53824SNLT](#) [PE-92100NL](#) [PG0434.801NLT](#) [PG0936.113NLT](#) [9310-16](#) [PM06-2N7](#) [PM06-39NJ](#) [A01TK](#) [1206CS-471XJ](#) [HC2-2R2TR](#) [HC2LP-R47-R](#) [HC3-2R2-R](#) [1206CS-151XG](#) [RCH664NP-140L](#) [RCH664NP-4R7M](#)  
[RCH8011NP-221L](#) [RCP1317NP-332L](#) [RCP1317NP-391L](#) [RCR1010NP-470M](#) [RCR110DNP-331L](#) [DH2280-4R7M](#) [DS1608C-106](#) [ASPI-4020HI-R10M-T](#) [B10TJ](#) [B82477P4333M](#) [B82498B3101J000](#) [B82498B3680J000](#) [ELJ-RE27NJF2](#) [1812CS-153XJ](#) [1812CS-183XJ](#) [1812CS-223XJ](#) [1812LS-104XJ](#) [1812LS-105XJ](#) [1812LS-124XJ](#) [1812LS-154XJ](#) [1812LS-223XJ](#) [1812LS-224XJ](#) [1812LS-563XJ](#)