

SMD Power Inductor CDRH2D14

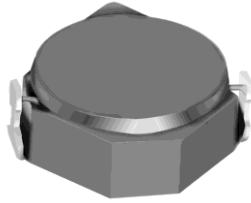

Description

- Ferrite drum core construction.
- Magnetically shielded.
- L × W × H: 3.2 × 3.2 × 1.55mm Max.
- Product weight: 46mg(Ref.)
- Moisture Sensitivity Level: 1
- RoHS compliance.

Dimension - [mm]

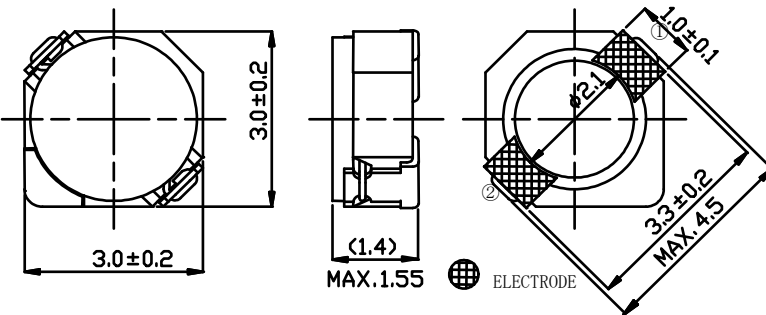

Land pattern and Schematics - [mm]

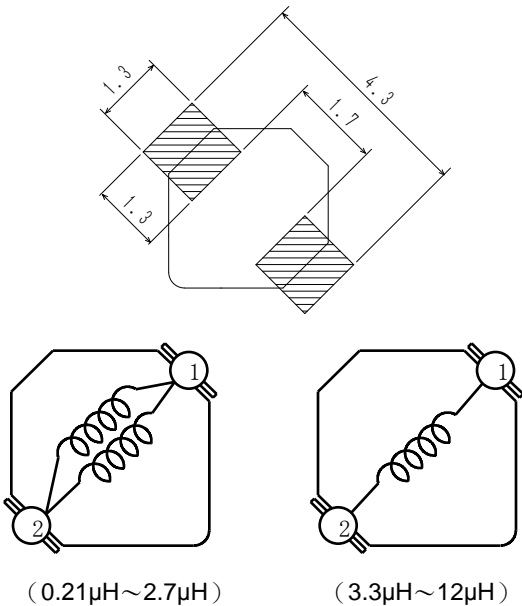

Environmental Data

- Operating temperature range: $-40^\circ\text{C} \sim +100^\circ\text{C}$ (including coil's self temperature rise)
- Storage temperature range: $-40^\circ\text{C} \sim +100^\circ\text{C}$
- Solder reflow temperature: 260°C peak.

Packaging

- Carrier tape and reel packaging
- 7.0" diameter reel
- 1000pcs per reel

Applications

- Ideally used in Mobilephone, PDA, MP3, DSC/DVC, etc. as DC-DC converter inductors.



Electrical Characteristics

Part Name	Stamp	Inductance (μH) [within] ※1	D.C.R. (m Ω) Max. (Typ.) (at 20°C)	Saturation Current (A) ※2		Temperature Rise Current (A) ※3
				at 20°C	at 100°C	
CDRH2D14NP-R21NC	N	0.21 \pm 35%	21(16)	3.80	2.70	4.74
CDRH2D14NP-R36NC	P	0.36 \pm 35%	26(20)	3.25	2.55	4.10
CDRH2D14NP-R60NC	Q	0.60 \pm 35%	33(25)	2.20	1.75	3.45
CDRH2D14NP-R82NC	R	0.82 \pm 35%	39(30)	2.10	1.68	2.85
CDRH2D14NP-1R2NC	S	1.2 \pm 30%	49(38)	1.95	1.35	2.75
CDRH2D14NP-1R5NC	A	1.5 \pm 30%	63(50)	1.80	1.20	2.00
CDRH2D14NP-1R8NC	B	1.8 \pm 30%	75(60)	1.65	1.10	1.80
CDRH2D14NP-2R2NC	C	2.2 \pm 30%	94(75)	1.50	1.00	1.60
CDRH2D14NP-2R7NC	D	2.7 \pm 30%	106(85)	1.35	0.90	1.40
CDRH2D14NP-3R3NC	E	3.3 \pm 30%	125(100)	1.20	0.82	1.24
CDRH2D14NP-3R9NC	F	3.9 \pm 30%	138(110)	1.10	0.75	1.12
CDRH2D14NP-4R7NC	G	4.7 \pm 30%	169(135)	1.00	0.68	1.00
CDRH2D14NP-5R6NC	H	5.6 \pm 30%	188(150)	0.95	0.60	0.98
CDRH2D14NP-6R8NC	J	6.8 \pm 30%	213(170)	0.85	0.56	0.92
CDRH2D14NP-8R2NC	K	8.2 \pm 30%	281(225)	0.80	0.51	0.80
CDRH2D14NP-100NC	L	10 \pm 30%	294(235)	0.70	0.46	0.76
CDRH2D14NP-120NC	M	12 \pm 30%	394(315)	0.62	0.42	0.64

※1 Inductance measuring condition: at 100 kHz.

※2 Saturation current: The DC current at which the inductance decreases to 65% of its nominal value.

※3 Temperature rise current: The DC current at which the temperature rise is $\Delta T=40^\circ\text{C}$. ($T_a=20^\circ\text{C}$)

SMD Power Inductor CDRH2D14



Saturation Current & Temperature Rise Graph

— L (20°C) — L (100°C) — ΔT

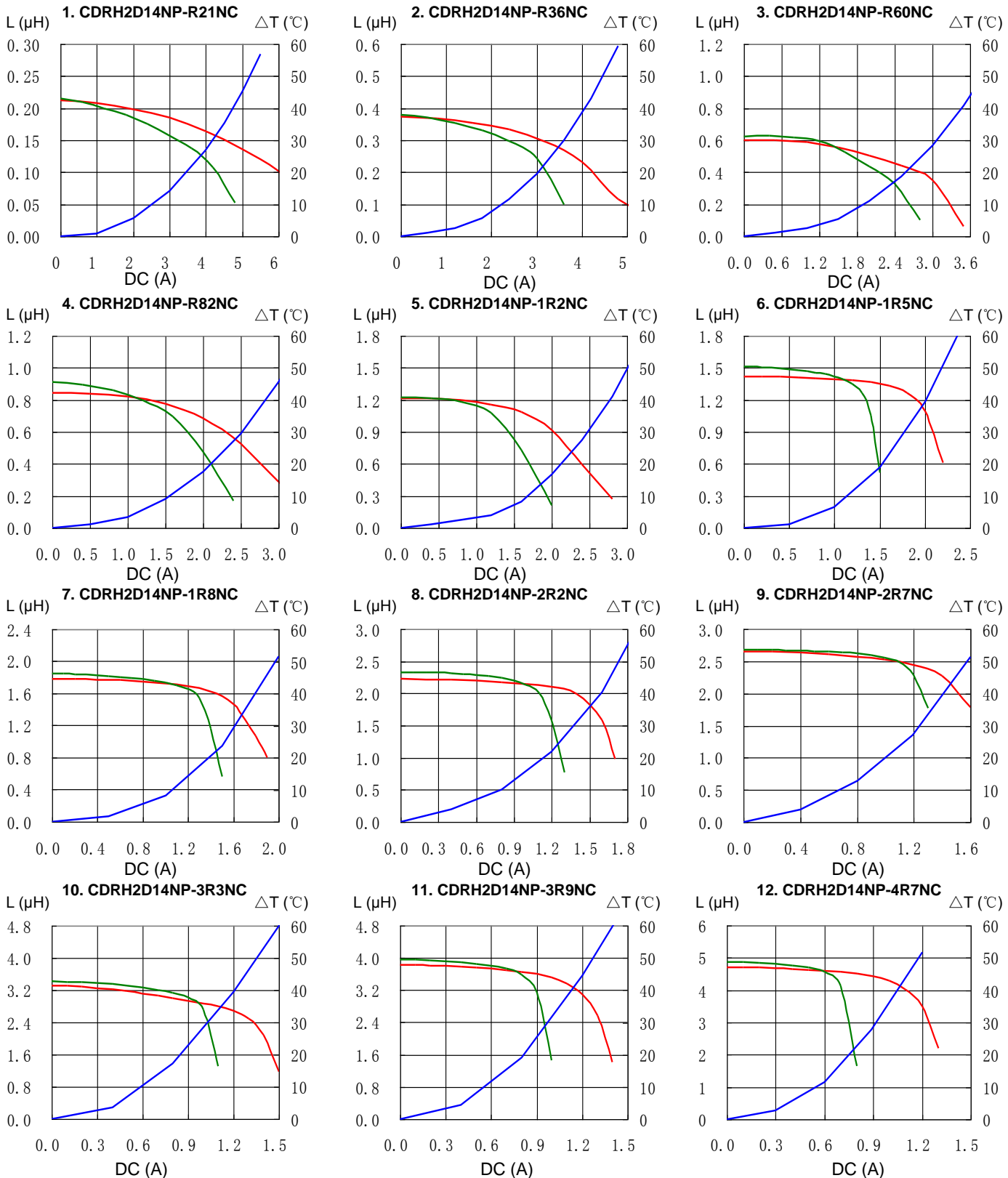

SMD Power Inductor CDRH2D14



Saturation Current & Temperature Rise Graph

— L (20°C) — L (100°C) — ΔT

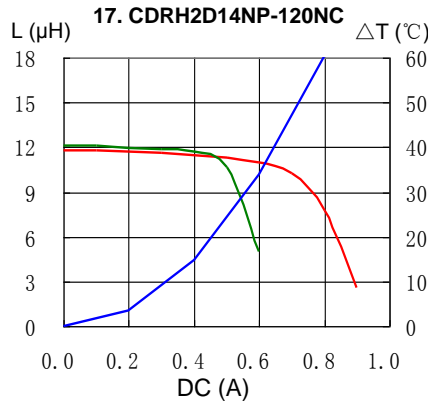
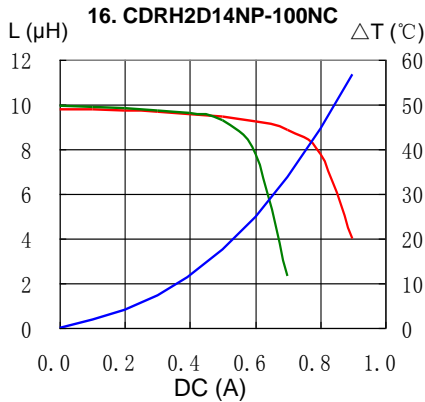
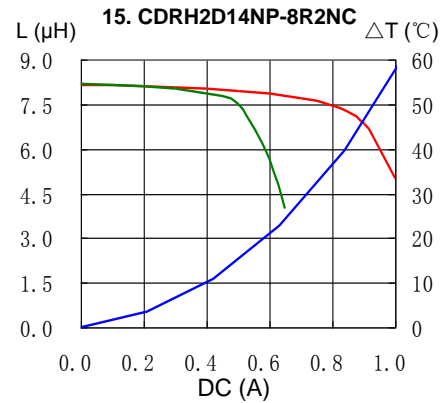
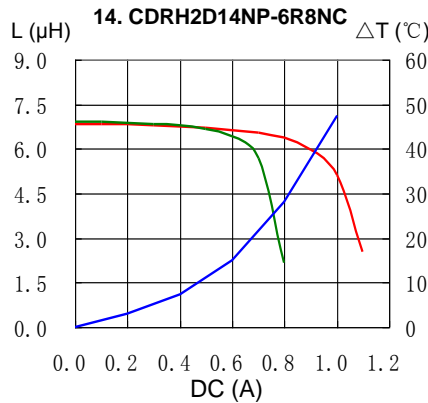
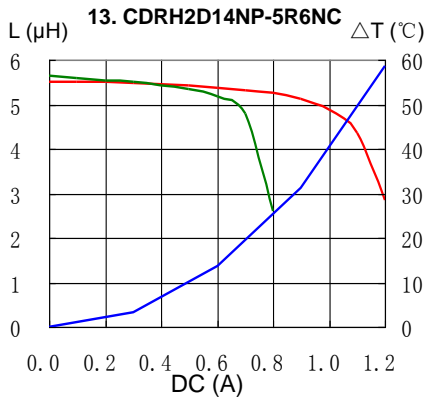

Solder Reflow Condition

Heat Endurance

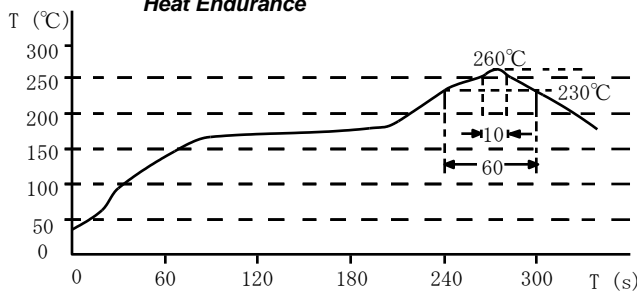

Temperature Chart

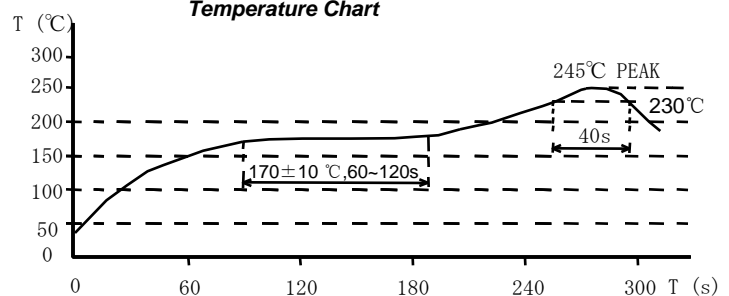

Please refer to the sales offices on our website - <http://www.sumida.com>

Hong Kong

Tel.+852-2880-6781
FAX.+852-2565-9600
sales@hk.sumida.com

Saitama(Japan)

Tel.+81-48-691-7300
FAX.+81-48-691-7340
sales@jp.sumida.com

Chicago

Tel.+1-847-545-6700
FAX. +1-847-545-6720
sales@us.sumida.com

Shanghai

Tel.+86-21-5836-3299
FAX.+86-21-5836-3266
shanghai.sales@cn.sumida.com

Seoul

Tel.+82-2-6237-0777
FAX.+82-2-6237-0778
sales@kr.sumida.com

Obernzell

Tel.+49-8591-937-0
FAX. +49-8591-937-103
contact@eu.sumida.com

Shenzhen

Tel.+86-755-8291-0228
FAX.+86-755-8291-0338
shenzhen.sales@cn.sumida.com

Singapore

Tel.+65-6296-3388
FAX.+65-6841-4426
sales@sg.sumida.com

Neumarkt

Tel.+49-9181-4509-110
FAX. +49-9181-4509-310
infocomp@eu.sumida.com

Taipei

Tel.+886-2-8751-2737
FAX.+886-2-8751-2738
sales@tw.sumida.com

San Jose

Tel.+1-408-321-9660
FAX.+1-408-321-9308
sales@us.sumida.com

X-ON Electronics

Largest Supplier of Electrical and Electronic Components

Click to view similar products for [Fixed Inductors](#) category:

Click to view products by [Sumida](#) manufacturer:

Other Similar products are found below :

[CR43NP-680KC](#) [CR54NP-820KC](#) [CR54NP-8R5MC](#) [CTX32CT-100](#) [70F224AI](#) [MGDQ4-00004-P](#) [MHL1ECTTP18NJ](#) [MHL1JCTTD12NJ](#)
[PE-51506NL](#) [PE-53601NL](#) [PE-53602NL](#) [PE-53630NL](#) [PE-53824SNLT](#) [PE-92100NL](#) [PG0434.801NLT](#) [PG0936.113NLT](#) [9310-16](#) [PM06-2N7](#) [PM06-39NJ](#) [A01TK](#) [1206CS-471XJ](#) [HC2-2R2TR](#) [HC2LP-R47-R](#) [HC3-2R2-R](#) [1206CS-151XG](#) [RCH664NP-140L](#) [RCH664NP-4R7M](#)
[RCH8011NP-221L](#) [RCP1317NP-332L](#) [RCP1317NP-391L](#) [RCR1010NP-470M](#) [RCR110DNP-331L](#) [DH2280-4R7M](#) [DS1608C-106](#) [ASPI-4020HI-R10M-T](#) [B10TJ](#) [B82477P4333M](#) [B82498B3101J000](#) [B82498B3680J000](#) [ELJ-RE27NJF2](#) [1812CS-153XJ](#) [1812CS-183XJ](#) [1812CS-223XJ](#) [1812LS-104XJ](#) [1812LS-105XJ](#) [1812LS-124XJ](#) [1812LS-154XJ](#) [1812LS-223XJ](#) [1812LS-224XJ](#) [1812LS-563XJ](#)