

SMD Power Inductor CDRH3D23/HP

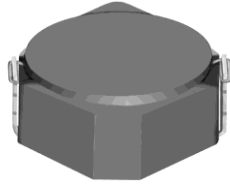
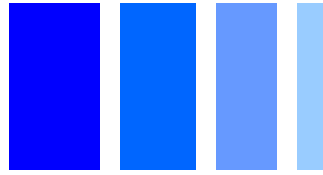

Description

- Ferrite drum core construction.
- Magnetically shielded.
- L × W × H: 3.92 × 3.92 × 2.5 mm Max.
- Product weight: 112mg(Ref.)
- Moisture Sensitivity Level: 1
- RoHS compliance.

Environmental Data

- Operating temperature range: -40°C ~ +105°C (including coil's self temperature rise)
- Storage temperature range: -40°C ~ +105°C
- Solder reflow temperature: 260 °C peak.

Packaging

- Carrier tape and reel packaging
- 7.0" diameter reel
- 500pcs per reel

Applications

- Ideally used in Mobilephone, PDA, MP3, DSC/DVC, etc. as DC-DC converter inductors.

Dimension - [mm]

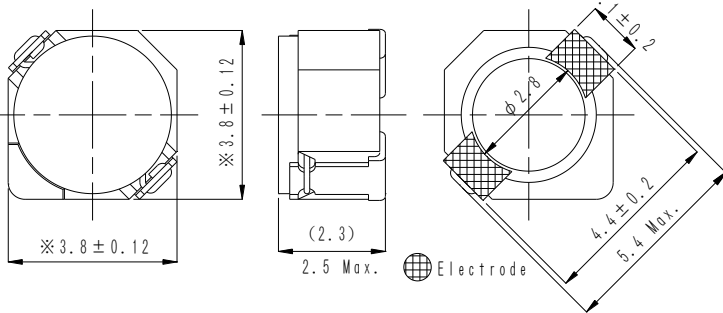

Land pattern and Schematics - [mm]

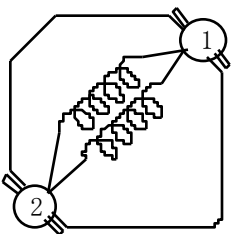
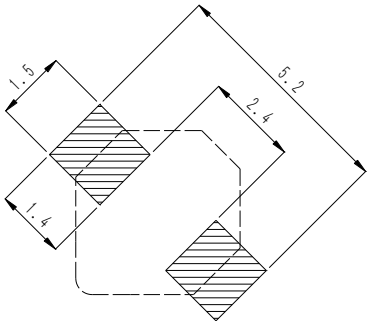

(1.2µH ~ 8.2µH)

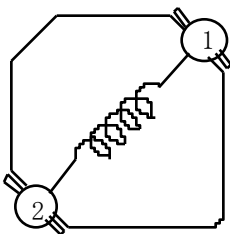

(10.0µH ~ 47.0µH)

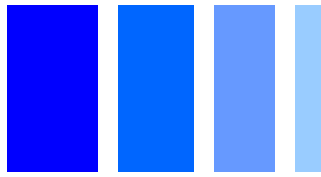

Electrical Characteristics

Part Name	Stamp	Inductance (μH) [within] ※1	D.C.R (m Ω) Max. (Typ.) (at 20°C)	Saturation Current (A) ※2		Temperature Rise Current (A) ※3
				at 20°C	at 105°C	
CDRH3D23HPNP-1R2PC	<u>B</u>	1.2 \pm 25%	40.4(32.3)	3.52	3.00	2.55
CDRH3D23HPNP-2R2PC	<u>E</u>	2.2 \pm 25%	50.3(40.2)	2.6	2.24	2.25
CDRH3D23HPNP-2R7PC	<u>F</u>	2.7 \pm 25%	62.3(49.8)	2.4	2.08	2.0
CDRH3D23HPNP-3R3PC	<u>G</u>	3.3 \pm 25%	70.0(56.0)	2.2	1.9	1.85
CDRH3D23HPNP-4R7PC	<u>J</u>	4.7 \pm 25%	95.5(76.4)	1.84	1.57	1.60
CDRH3D23HPNP-5R6PC	<u>K</u>	5.6 \pm 25%	102(81.2)	1.66	1.44	1.50
CDRH3D23HPNP-6R8PC	<u>L</u>	6.8 \pm 25%	136(109)	1.52	1.30	1.30
CDRH3D23HPNP-8R2PC	<u>N</u>	8.2 \pm 25%	145(116)	1.36	1.18	1.25
CDRH3D23HPNP-100MC	A	10 \pm 20%	198(158)	1.28	1.08	1.02
CDRH3D23HPNP-120MC	B	12 \pm 20%	249(199)	1.14	0.97	0.95
CDRH3D23HPNP-150MC	C	15 \pm 20%	276(221)	1.02	0.88	0.90
CDRH3D23HPNP-220MC	E	22 \pm 20%	383(306)	0.80	0.65	0.70
CDRH3D23HPNP-330MC	G	33 \pm 20%	555(444)	0.68	0.58	0.58
CDRH3D23HPNP-470MC	J	47 \pm 20%	798(638)	0.56	0.48	0.45

※1. Inductance measuring condition: at 100kHz.

※2. Saturation current: The value of D.C. current when the inductance decreases to 70% of it's nominal value.

※3. Temperature rise current: The value of D.C. current when the temperature rise is $\Delta t=40^\circ\text{C}$ ($T_a=20^\circ\text{C}$).

SMD Power Inductor CDRH3D23/HP

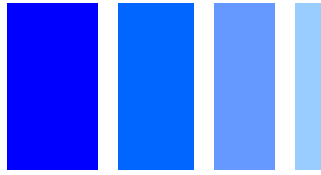

Saturation Current & Temperature Rise Graph

— L (20°C) — L (100°C) — ΔT

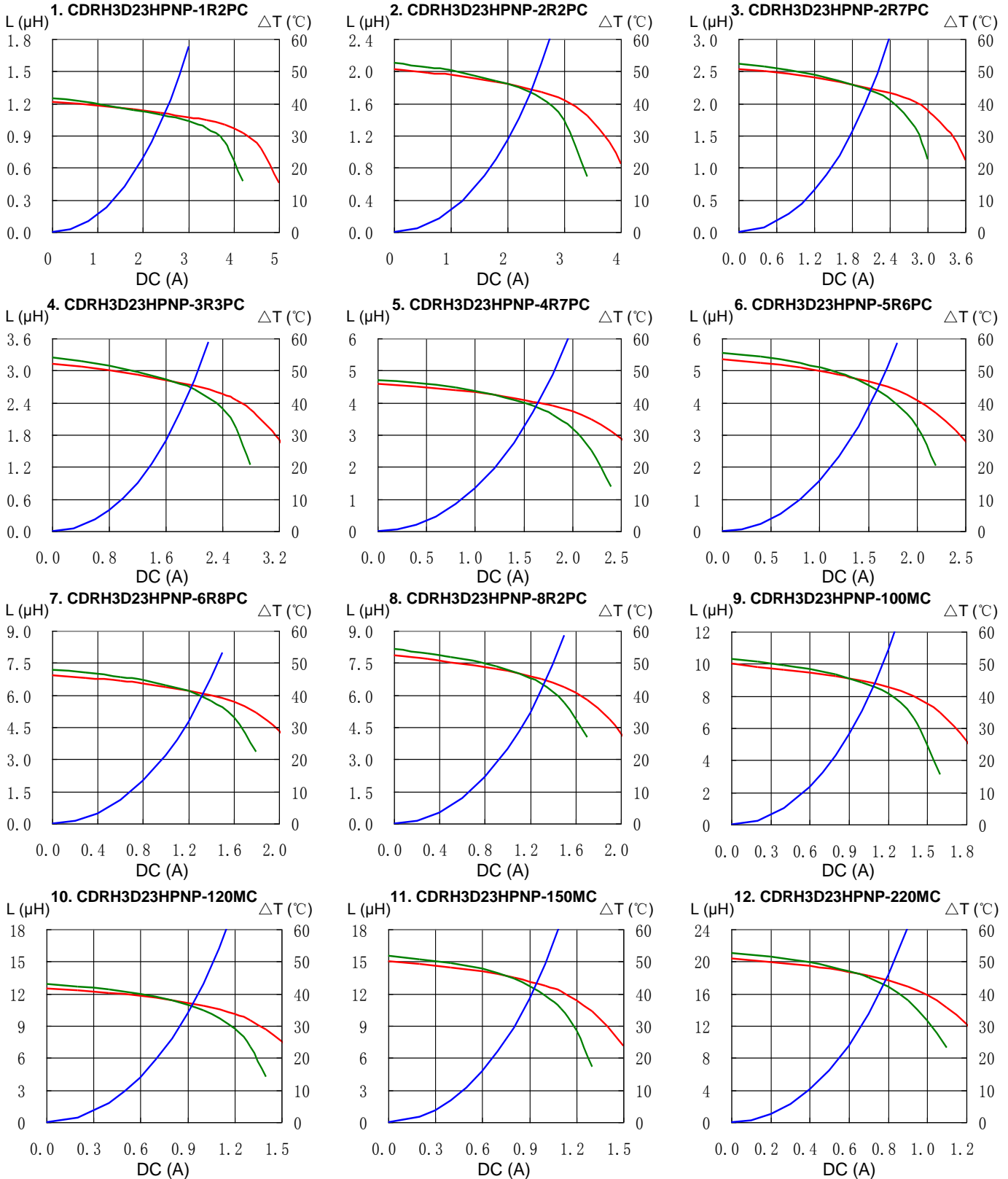

SMD Power Inductor CDRH3D23/HP

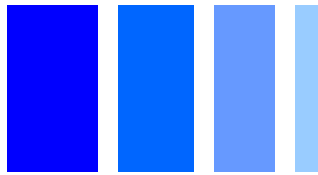

Saturation Current & Temperature Rise Graph

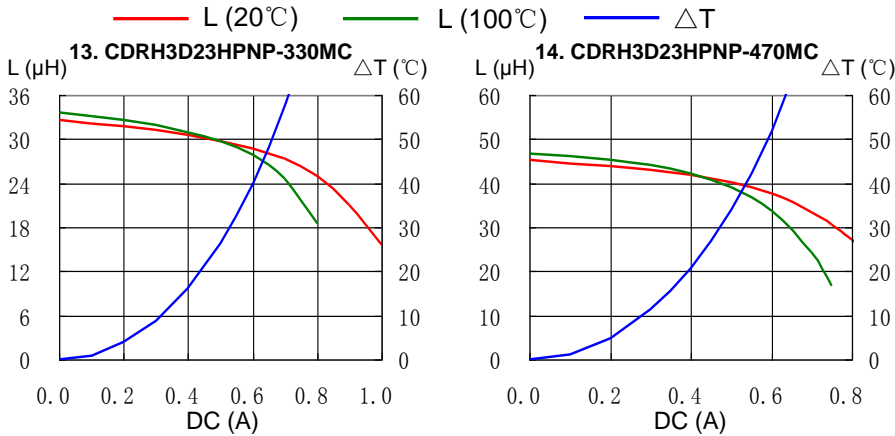

Solder Reflow Condition

Heat Endurance

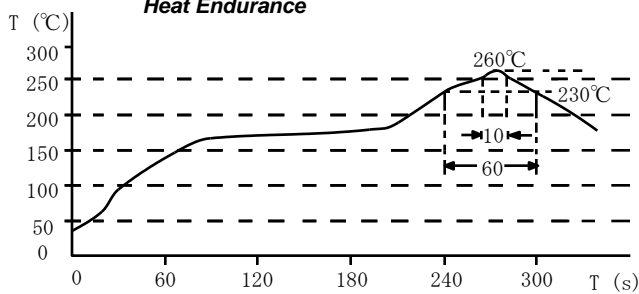

Temperature Chart

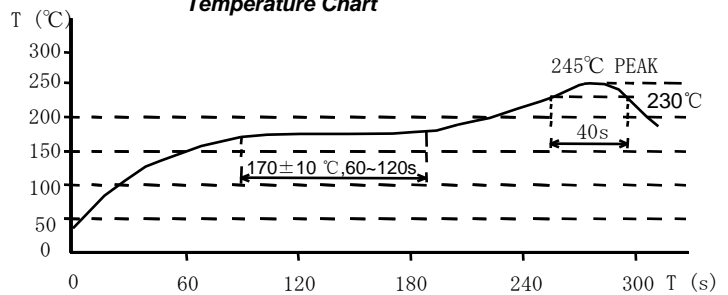

Please refer to the sales offices on our website - <http://www.sumida.com>

Hong Kong

Tel.+852-2880-6781
FAX.+852-2565-9600
sales@hk.sumida.com

Saitama(Japan)

Tel.+81-48-691-7300
FAX.+81-48-691-7340
sales@jp.sumida.com

Chicago

Tel.+1-847-545-6700
FAX. +1-847-545-6720
sales@us.sumida.com

Shanghai

Tel.+86-21-5836-3299
FAX.+86-21-5836-3266
shanghai.sales@cn.sumida.com

Seoul

Tel.+82-2-6237-0777
FAX.+82-2-6237-0778
sales@kr.sumida.com

Obernzell

Tel.+49-8591-937-0
FAX. +49-8591-937-103
contact@eu.sumida.com

Shenzhen

Tel.+86-755-8291-0228
FAX.+86-755-8291-0338
shenzhen.sales@cn.sumida.com

Singapore

Tel.+65-6296-3388
FAX.+65-6841-4426
sales@sg.sumida.com

Neumarkt

Tel.+49-9181-4509-110
FAX. +49-9181-4509-310
infocomp@eu.sumida.com

Taipei

Tel.+886-2-8751-2737
FAX.+886-2-8751-2738
sales@tw.sumida.com

San Jose

Tel.+1-408-321-9660
FAX.+1-408-321-9308
sales@us.sumida.com

X-ON Electronics

Largest Supplier of Electrical and Electronic Components

Click to view similar products for [Fixed Inductors](#) category:

Click to view products by [Sumida](#) manufacturer:

Other Similar products are found below :

[CR43NP-680KC](#) [CR54NP-820KC](#) [CR54NP-8R5MC](#) [CTX32CT-100](#) [70F224AI](#) [MGDQ4-00004-P](#) [MHL1ECTTP18NJ](#) [MHL1JCTTD12NJ](#)
[PE-51506NL](#) [PE-53601NL](#) [PE-53602NL](#) [PE-53630NL](#) [PE-53824SNLT](#) [PE-92100NL](#) [PG0434.801NLT](#) [PG0936.113NLT](#) [9310-16](#) [PM06-2N7](#) [PM06-39NJ](#) [A01TK](#) [1206CS-471XJ](#) [HC2-2R2TR](#) [HC2LP-R47-R](#) [HC3-2R2-R](#) [1206CS-151XG](#) [RCH664NP-140L](#) [RCH664NP-4R7M](#)
[RCH8011NP-221L](#) [RCP1317NP-332L](#) [RCP1317NP-391L](#) [RCR1010NP-470M](#) [RCR110DNP-331L](#) [DH2280-4R7M](#) [DS1608C-106](#) [ASPI-4020HI-R10M-T](#) [B10TJ](#) [B82477P4333M](#) [B82498B3101J000](#) [B82498B3680J000](#) [ELJ-RE27NJF2](#) [1812CS-153XJ](#) [1812CS-183XJ](#) [1812CS-223XJ](#) [1812LS-104XJ](#) [1812LS-105XJ](#) [1812LS-124XJ](#) [1812LS-154XJ](#) [1812LS-223XJ](#) [1812LS-224XJ](#) [1812LS-563XJ](#)