

SMD Power Inductor

CDRH40D18/A



特点

- Ferrite drum core construction
- Magnetically shielded
- L×W×H: 4.5×4.5×2.0 mm Max.
- Product weight: 0.1g(Ref.)
- Moisture Sensitivity Level: 1
- Qualification to AEC-Q200



环境规格

- Operating Temperature: -40°C to +125°C (including self-heating)
- Storage temperature range: -40°C~+85°C

包装

- Carrier tape and reel packaging

用途

- High temp and high reliability automotive applications

外形尺寸 - [mm]

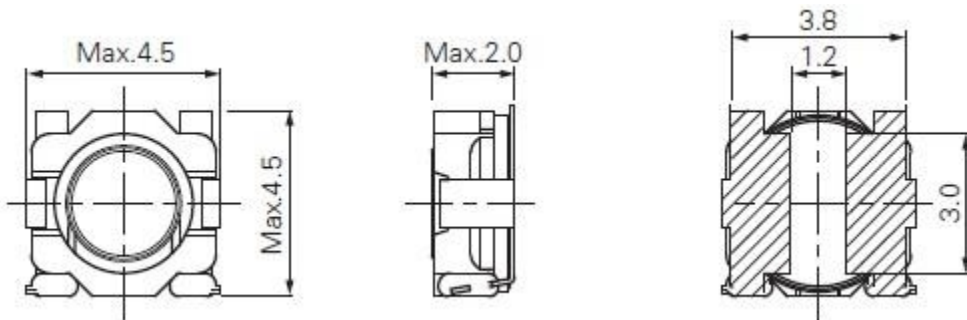

推荐焊盘尺寸 - [mm]

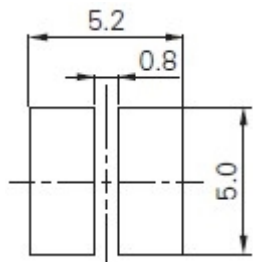

接线图 (底面)

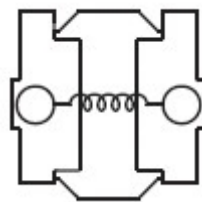



电气特性规格

品名	电感值 [within] (μ H) ※1	直流电阻 (20℃) Max. (Typ.) (m Ω)	饱和电流 (A) Max. (Typ.) ※2	温度上升电流 (A) Max. (Typ.) ※3
CDRH40D18ANP-2R2NC	2.20 \pm 30%	63.00 (50.00)	1.36 (2.14)	(1.82)
CDRH40D18ANP-3R3NC	3.30 \pm 30%	108 (86.00)	1.10 (1.77)	(1.45)
CDRH40D18ANP-4R7NC	4.70 \pm 30%	128 (102)	0.84 (1.39)	(1.34)
CDRH40D18ANP-6R8NC	6.80 \pm 30%	205 (164)	0.73 (1.22)	(0.99)
CDRH40D18ANP-100NC	10.00 \pm 30%	338 (270)	0.59 (0.98)	(0.72)
CDRH40D18ANP-150NC	15.00 \pm 30%	428 (342)	0.49 (0.82)	(0.65)
CDRH40D18ANP-220NC	22.00 \pm 30%	615 (492)	0.41 (0.66)	(0.57)
CDRH40D18ANP-330NC	33.00 \pm 30%	1175 (940)	0.31 (0.54)	(0.37)
CDRH40D18ANP-470NC	47.00 \pm 30%	1500 (1200)	0.28 (0.45)	(0.35)

※1. Inductance measuring condition: at 100 kHz.

※2. Rated current: The DC current at which the inductance decreases to 65% of its nominal value or when $\Delta t=30^{\circ}\text{C}$, whichever is lower.

回流焊耐热与推荐温度曲线图

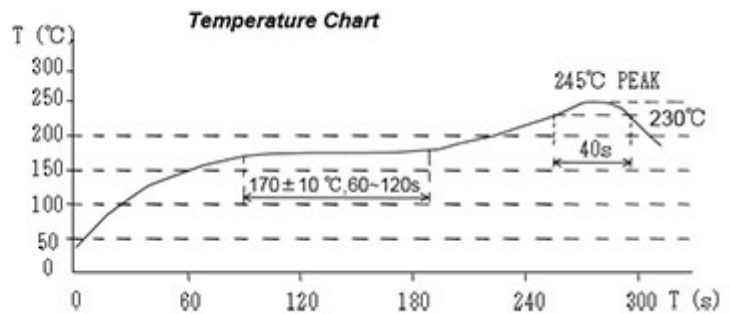
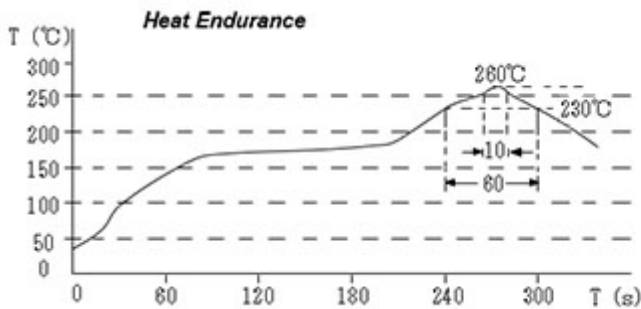



直流饱和电流&温度上升曲线图

— L (20°C) — L (155°C) — ΔT

1. CDRH40D18ANP-2R2NC

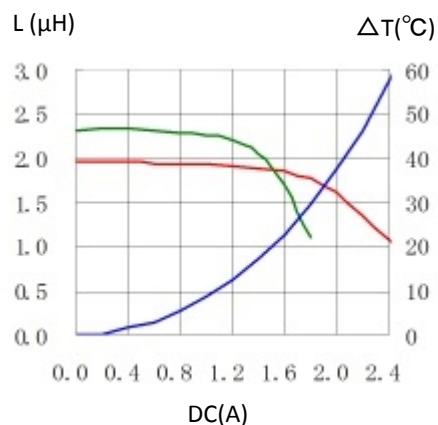

2. CDRH40D18ANP-3R3NC

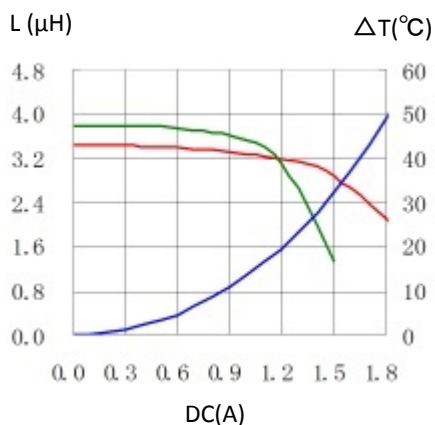

3. CDRH40D18ANP-4R7NC

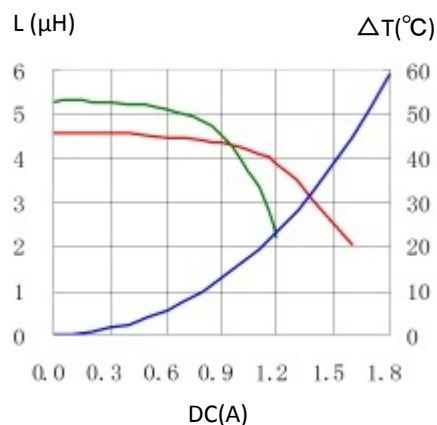

4. CDRH40D18ANP-6R8NC

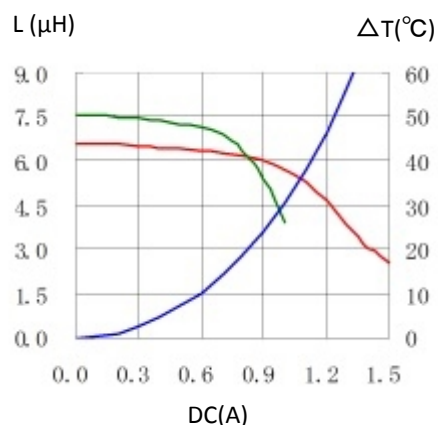

5. CDRH40D18ANP-100NC

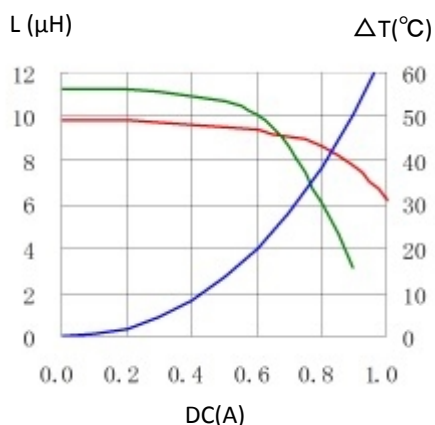

6. CDRH40D18ANP-150NC

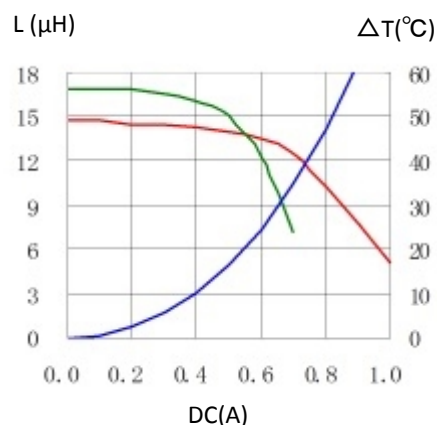

7. CDRH40D18ANP-220NC

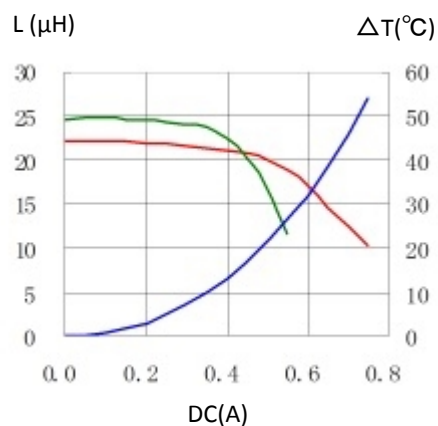

8. CDRH40D18ANP-330NC

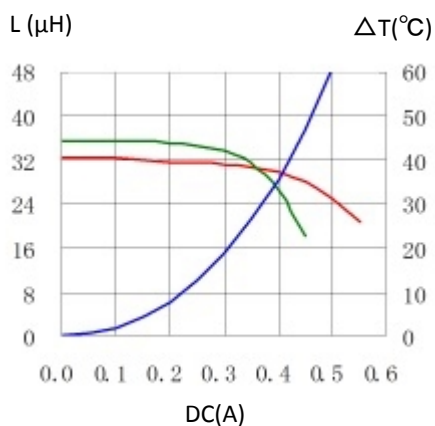

9. CDRH40D18ANP-470NC

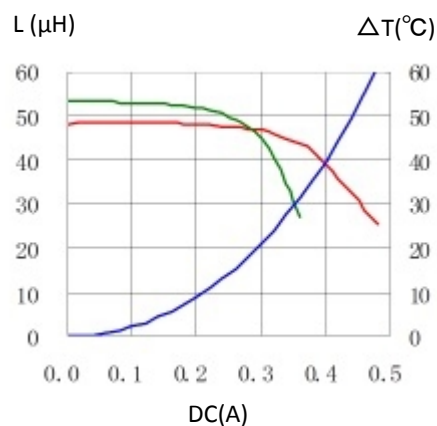

有关销售办事处的信息，请 [点击这里](#)。

X-ON Electronics

Largest Supplier of Electrical and Electronic Components

Click to view similar products for [Power Inductors - SMD category](#):

Click to view products by [Sumida manufacturer](#):

Other Similar products are found below :

[SPD62R-472M](#) [LLQPB201214T1R0M](#) [LLXND3030QKT470MNG](#) [LLQPB160807T4R7M](#) [LLAPB2016KKTR33M](#)
[LBXND4040TKL330MDG](#) [LLXNE3030KKT4R7MN](#) [LSQEA201212T100M](#) [IHLP5050CEER4R7M06](#) [LVS505020-1R0T-N](#) [LVS505040-1R2T-N](#) [LVS606020-1R5M-N](#) [LVS606028-6R8M-N](#) [LVS606045-102M-N](#) [LVS606045-150M-N](#) [LVS606045-1R8M-N](#) [LVS606045-6R8M-N](#) [LVS808040-2R0M-N](#) [LVS808040-330M-N](#) [LVS808040-4R7M-N](#) [MHCI06030-R56M-R8](#) [SCD0403T-470M-N](#) [SCD0403T-6R8K-N](#) [SCD0504T-101M-N](#) [SCD0504T-120M-N](#) [SCD0504T-221M-N](#) [SCD0504T-470M-N](#) [SCD0504T-471M-N](#) [SCD0705T-180M-N](#) [SCD0705T-221M-N](#) [SCD0705T-470M-N](#) [SCD1005T-101M-N](#) [SCD1005T-221M-N](#) [SCD1005T-470M-N](#) [SSL1306T-101M-N](#) [LQB15NNR27K10D](#) [201610CDMCDDS-R47MC](#) [201610CDMCDDS-1R0MC](#) [201610CDMCDDS-R68MC](#) [LSQPB201210T220M](#) [LBCNF2012KKTR24MA](#) [LSQEA201212T220K](#) [LSENC2016KKT1R0M](#) [LSBHB1608KKT2R2MG](#) [LSQPB160807T2R2M](#) [LSQEA201212T101K](#) [LCXND4040MKL4R7MDG](#) [DEM8045Z-5R6N=P3](#) [LCXNH8080YKL101MJG](#) [LSCNA2012KKT1R0MA](#)