

# SMD Power Inductor

## CDRH40D28/T125



### Description

- Ferrite drum core construction.
- Magnetically shielded.
- LxWxH:4.5x4.5x3.0mm Max.
- Product weight:0.13 g (Ref.)
- Moisture Sensitivity Level: 1



### Environmental Data

- Operating temperature range: -40°C~+125°C (including coil's self temperature rise)
- Storage condition of before PCB mounting : Ta:5~40°C, RH:20~70%

### Packaging

- Carrier tape and reel packaging.
- 13.0" diameter reel. 2000pcs per reel.

### Applications

- Automotive application and other high temperature,high reliability application type withstand up to 125°C.

### Dimension - [mm]

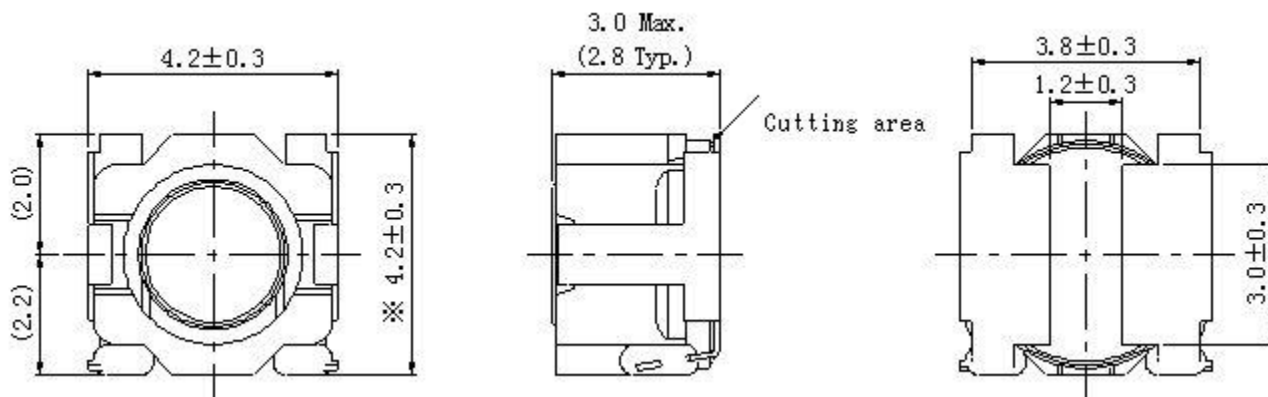

### Recommended Land pattern - [mm]

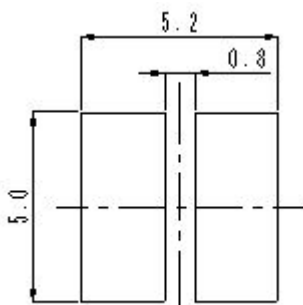

### Wire Connection

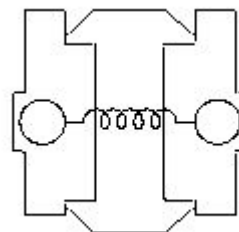

# SMD Power Inductor

## CDRH40D28/T125



### Electrical Characteristics

Part Number	Inductance [Within] ( $\mu$ H) ※1	D.C.R. at 20°C Max.(Typ.) (m $\Omega$ )	Saturation Current (A) Max.(Typ.) ※2		Temperature Rise Current (A) Max.(Typ.) ※3
			20°C	125°C	
CDRH40D28T125NP-1R5NC	1.50 $\pm$ 30%	43.50 (35.00)	2.20 (2.76)	1.92 (2.41)	(3.00)
CDRH40D28T125NP-1R8NC	1.80 $\pm$ 30%	50.00 (40.00)	2.00 (2.50)	1.76 (2.20)	(2.75)
CDRH40D28T125NP-2R2NC	2.20 $\pm$ 30%	56.00 (45.00)	1.85 (2.32)	1.56 (1.95)	(2.70)
CDRH40D28T125NP-3R3NC	3.30 $\pm$ 30%	68.50 (55.00)	1.59 (1.99)	1.36 (1.70)	(2.35)
CDRH40D28T125NP-4R7NC	4.70 $\pm$ 30%	85.00 (68.00)	1.29 (1.62)	1.12 (1.40)	(2.00)
CDRH40D28T125NP-5R6NC	5.60 $\pm$ 30%	112 (90.00)	1.20 (1.50)	1.03 (1.29)	(1.70)
CDRH40D28T125NP-6R8NC	6.80 $\pm$ 30%	118 (95.00)	1.08 (1.35)	0.93 (1.16)	(1.65)
CDRH40D28T125NP-100NC	10.00 $\pm$ 30%	188 (150)	0.82 (1.02)	0.72 (0.90)	(1.35)
CDRH40D28T125NP-150NC	15.00 $\pm$ 30%	240 (192)	0.72 (0.90)	0.62 (0.77)	(1.20)
CDRH40D28T125NP-220NC	22.00 $\pm$ 30%	338 (270)	0.61 (0.76)	0.53 (0.66)	(0.90)
CDRH40D28T125NP-330NC	33.00 $\pm$ 30%	619 (495)	0.49 (0.61)	0.42 (0.52)	(0.66)

※1 Measuring frequency inductance at 100kHz,1V.

※2 Saturation current: This indicates the actual value of D.C. current when the inductance becomes 35% lower than its nominal value.

※3 Temperature rise current: The actual value of D.C. current when the temperature of coil becomes  $\Delta T=40^{\circ}\text{C}$  ( $T_a=20^{\circ}\text{C}$ ).

### Solder Reflow Condition

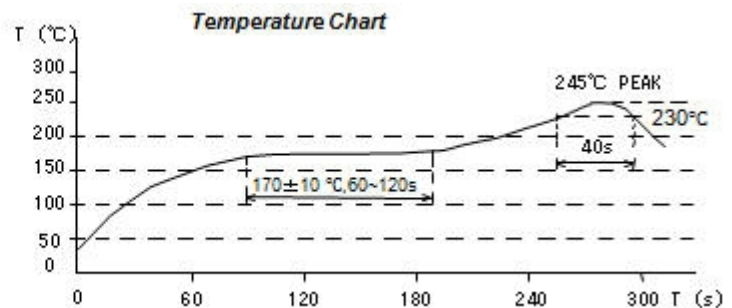
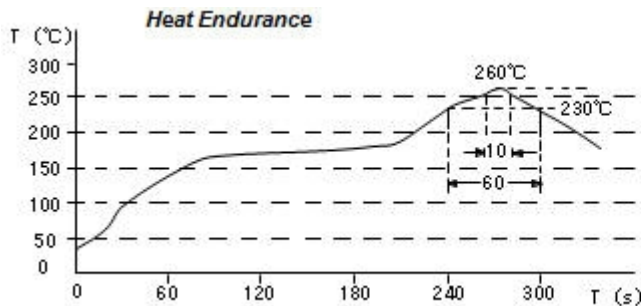

# SMD Power Inductor

## CDRH40D28/T125



Recommended Type

### Saturation Current & Temperature Rise Graph

— L (20°C)    — L (125°C)    — ΔT

1. CDRH40D28T125NP-1R5NC

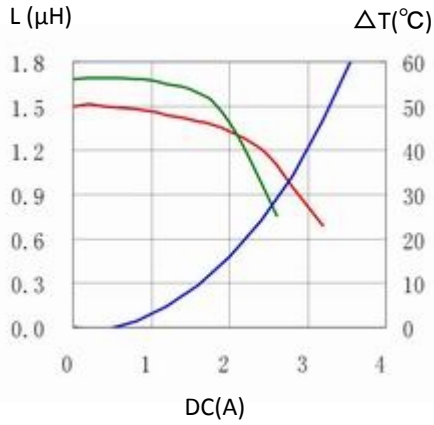

2. CDRH40D28T125NP-1R8NC

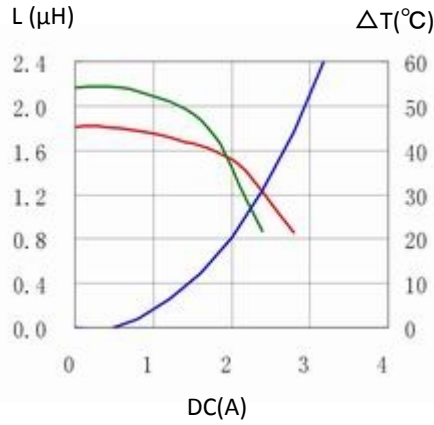

3. CDRH40D28T125NP-2R2NC

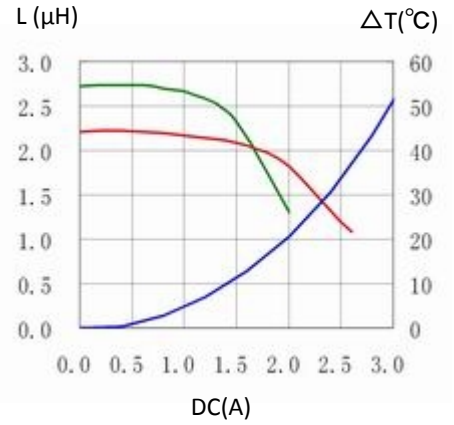

4. CDRH40D28T125NP-3R3NC

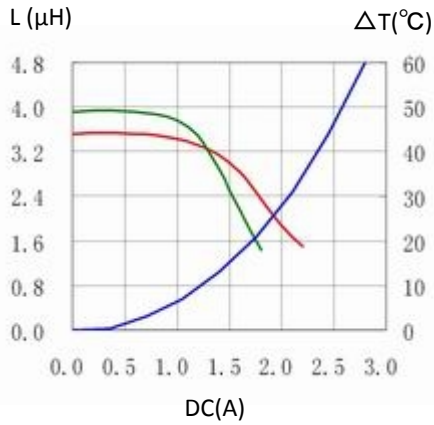

5. CDRH40D28T125NP-4R7NC

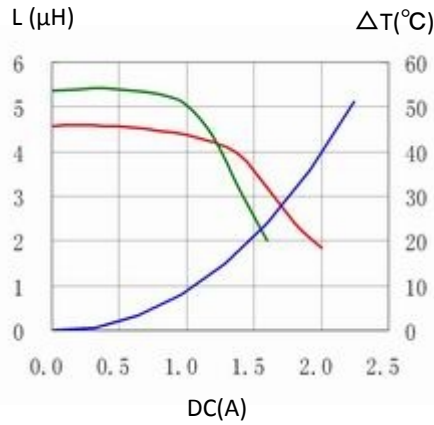

6. CDRH40D28T125NP-5R6NC

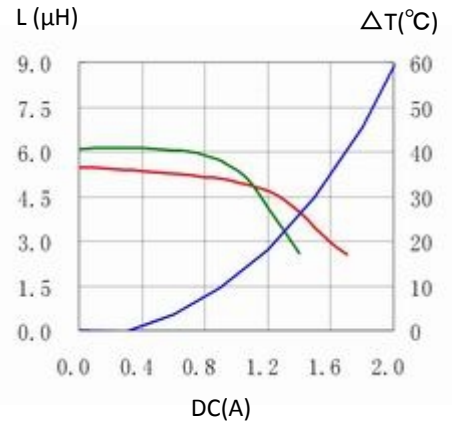

7. CDRH40D28T125NP-6R8NC

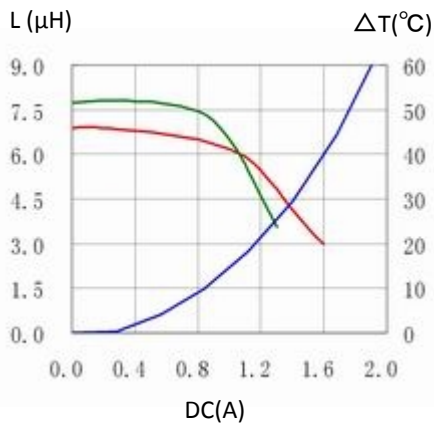

8. CDRH40D28T125NP-100NC

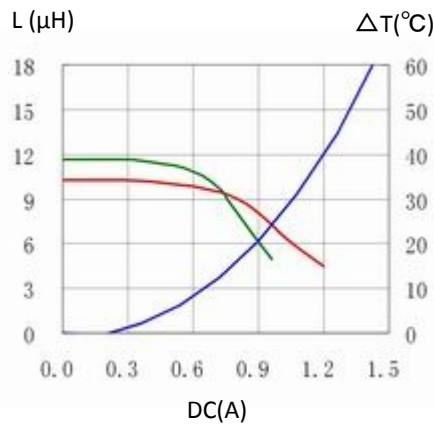

9. CDRH40D28T125NP-150NC

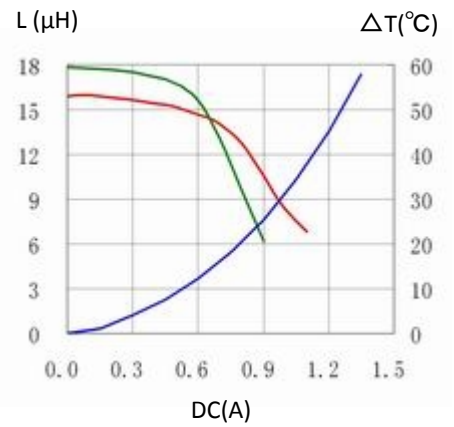

# SMD Power Inductor

## CDRH40D28/T125



Recommended Type

10. CDRH40D28T125NP-220NC

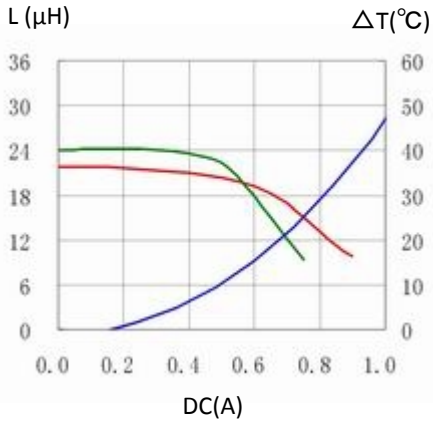

11. CDRH40D28T125NP-330NC

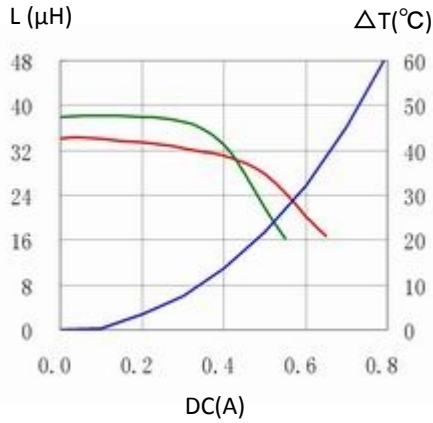

For sales office information, please [click here](#) to visit our website.

## X-ON Electronics

Largest Supplier of Electrical and Electronic Components

*Click to view similar products for [Power Inductors - SMD category](#):*

*Click to view products by [Sumida manufacturer](#):*

Other Similar products are found below :

[SPD62R-472M](#) [LLQPB201214T1R0M](#) [LLXND3030QKT470MNG](#) [LLQPB160807T4R7M](#) [LLAPB2016KKTR33M](#)  
[LBXND4040TKL330MDG](#) [LLXNE3030KKT4R7MN](#) [LSQEA201212T100M](#) [IHLP5050CEER4R7M06](#) [LVS505020-1R0T-N](#) [LVS505040-1R2T-N](#) [LVS606020-1R5M-N](#) [LVS606028-6R8M-N](#) [LVS606045-102M-N](#) [LVS606045-150M-N](#) [LVS606045-1R8M-N](#) [LVS606045-6R8M-N](#) [LVS808040-2R0M-N](#) [LVS808040-330M-N](#) [LVS808040-4R7M-N](#) [MHCI06030-R56M-R8](#) [SCD0403T-470M-N](#) [SCD0403T-6R8K-N](#) [SCD0504T-101M-N](#) [SCD0504T-120M-N](#) [SCD0504T-221M-N](#) [SCD0504T-470M-N](#) [SCD0504T-471M-N](#) [SCD0705T-180M-N](#) [SCD0705T-221M-N](#) [SCD0705T-470M-N](#) [SCD1005T-101M-N](#) [SCD1005T-221M-N](#) [SCD1005T-470M-N](#) [SSL1306T-101M-N](#) [LQB15NNR27K10D](#) [201610CDMCDDS-R47MC](#) [201610CDMCDDS-1R0MC](#) [201610CDMCDDS-R68MC](#) [LSQPB201210T220M](#) [LBCNF2012KKTR24MA](#) [LSQEA201212T220K](#) [LSENC2016KKT1R0M](#) [LSBHB1608KKT2R2MG](#) [LSQPB160807T2R2M](#) [LSQEA201212T101K](#) [LCXND4040MKL4R7MDG](#) [DEM8045Z-5R6N=P3](#) [LCXNH8080YKL101MJG](#) [LSCNA2012KKT1R0MA](#)