

SMD Power Inductor CDRH4D28C



Description

- Ferrite drum core construction.
- Magnetically shielded.
- L × W × H: 5.1 × 5.1 × 3.0 mm Max.
- Product weight: 0.21g(Ref.)
- Moisture Sensitivity Level: 1
- RoHS compliance.

Environmental Data

- Operating temperature range: -40°C ~ +105°C (including coil's self temperature rise)
- Storage temperature range: -40°C ~ +105°C
- Solder reflow temperature: 260 °C peak.

Packaging

- Carrier tape and reel packaging
- 12.9" diameter reel
- 2000pcs per reel

Applications

- Ideally used in Mobile phone, PDA, MP3, HDD, DSC/DVC, Note book PC, etc as DC-DC converter inductors.

Dimension - [mm]

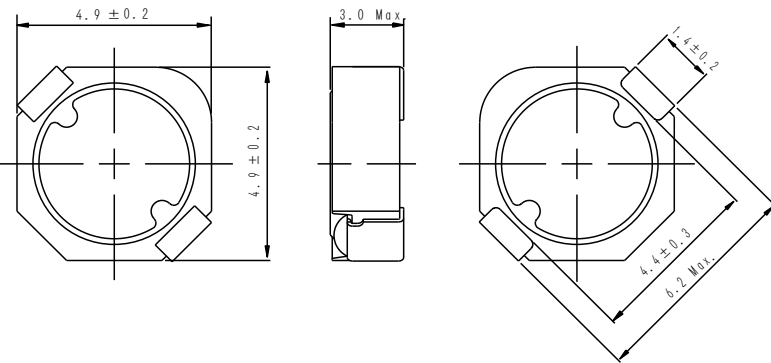

Land pattern and Schematics - [mm]

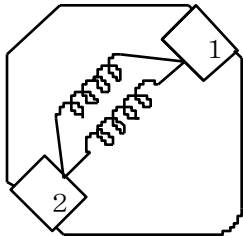
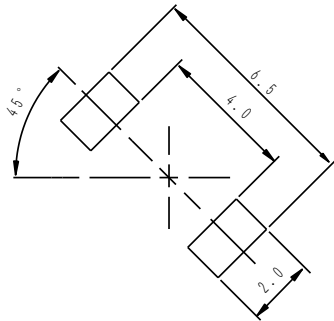

(1.1µH ~ 6.3µH)

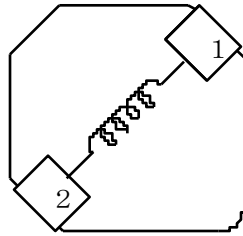

(10µH ~ 100µH)



Electrical Characteristics

Part No.	Stamp	Inductance (μ H) [within] ※1	D.C.R.(Ω) Max. (Typ.) (at 20°C)	Rated Current (A) ※2
CDRH4D28CNP-1R1PC	A	1.1 \pm 25%	22m(17.5m)	3.80
CDRH4D28CNP-2R0PC	B	2.0 \pm 25%	29m(23.0m)	2.60
CDRH4D28CNP-3R2PC	C	3.2 \pm 25%	42m(33.3m)	2.30
CDRH4D28CNP-4R7PC	D	4.7 \pm 25%	63m(50.0m)	1.80
CDRH4D28CNP-6R3PC	E	6.3 \pm 25%	94m(75.0m)	1.30
CDRH4D28CNP-100PC	F	10 \pm 25%	106m(85.0m)	1.26
CDRH4D28CNP-150PC	G	15 \pm 25%	137m(110m)	1.05
CDRH4D28CNP-220PC	H	22 \pm 25%	207m(166m)	0.85
CDRH4D28CNP-330PC	I	33 \pm 25%	331m(265m)	0.70
CDRH4D28CNP-470PC	J	47 \pm 25%	510m(408m)	0.54
CDRH4D28CNP-680PC	K	68 \pm 25%	625m(500m)	0.49
CDRH4D28CNP-101PC	L	100 \pm 25%	948m(758m)	0.40

※1. Inductance measuring condition: at 100kHz.

※2. Rated current: The DC current at which the inductance decreases to 65% of its nominal value or when $\Delta t=40^{\circ}\text{C}$, whichever is lower ($T_a=20^{\circ}\text{C}$).

SMD Power Inductor CDRH4D28C



Saturation Current & Temperature Rise Graph

— L (20°C) — L (100°C) — ΔT

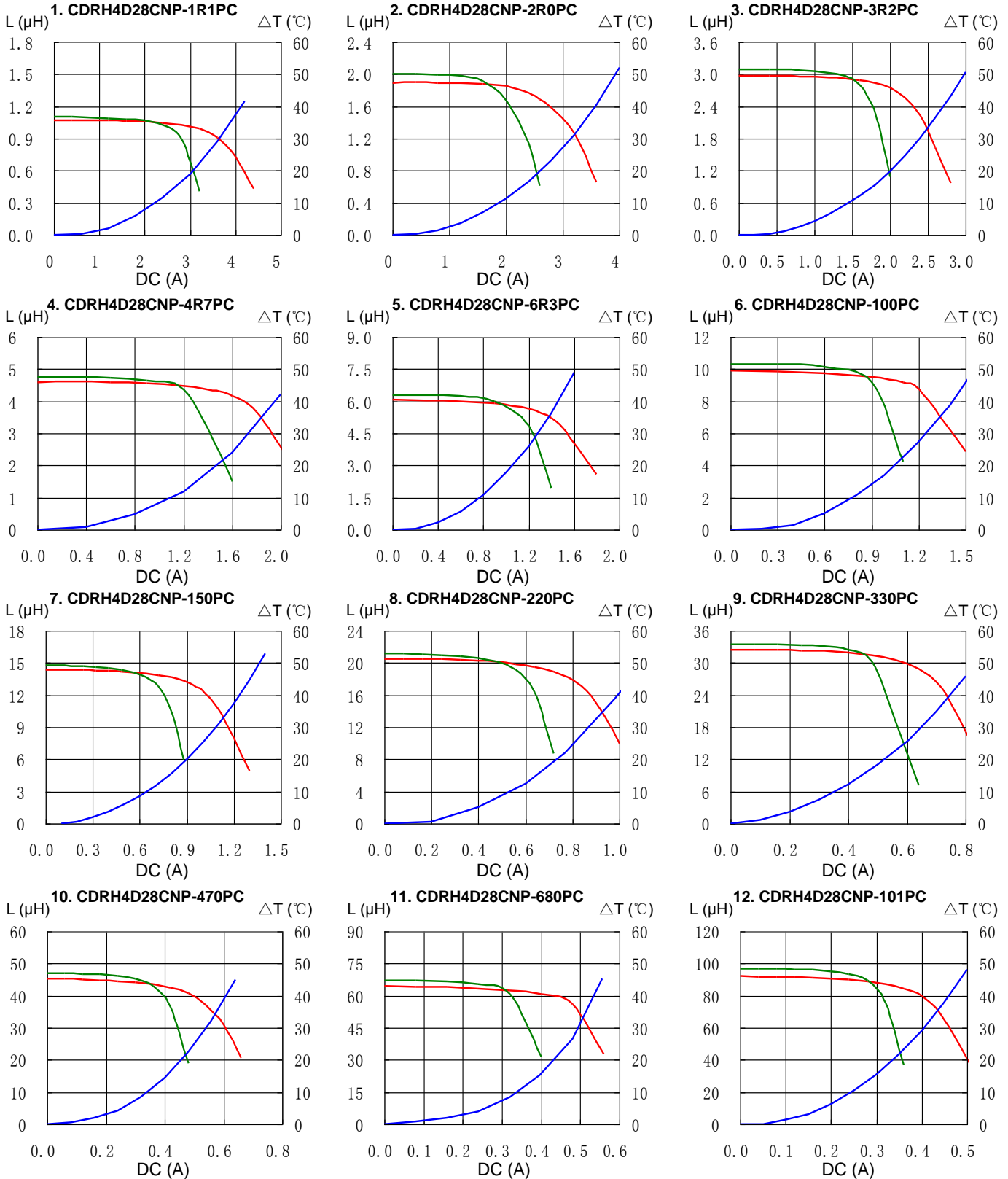

SMD Power Inductor CDRH4D28C



Solder Reflow Condition

Heat Endurance

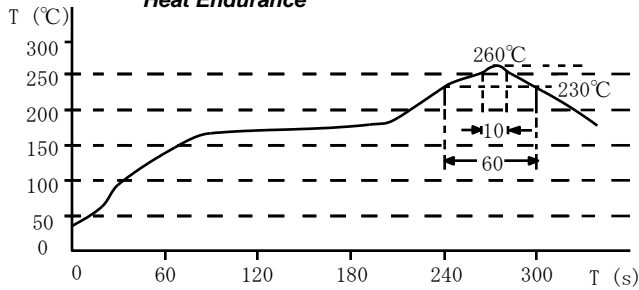

Temperature Chart

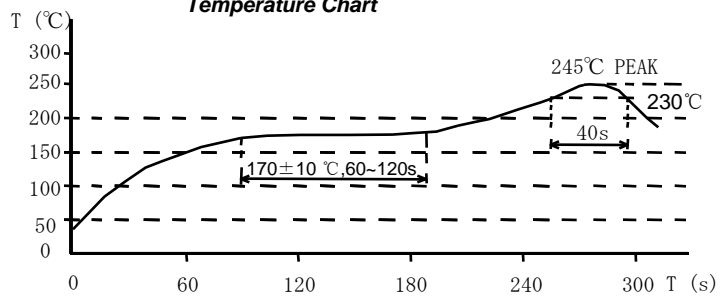

Please refer to the sales offices on our website - <http://www.sumida.com>

Hong Kong

Tel.+852-2880-6781
FAX.+852-2565-9600
sales@hk.sumida.com

Saitama(Japan)

Tel.+81-48-691-7300
FAX.+81-48-691-7340
sales@jp.sumida.com

Chicago

Tel.+1-847-545-6700
FAX. +1-847-545-6720
sales@us.sumida.com

Shanghai

Tel.+86-21-5836-3299
FAX.+86-21-5836-3266
shanghai.sales@cn.sumida.com

Seoul

Tel.+82-2-6237-0777
FAX.+82-2-6237-0778
sales@kr.sumida.com

Obernzell

Tel.+49-8591-937-0
FAX. +49-8591-937-103
contact@eu.sumida.com

Shenzhen

Tel.+86-755-8291-0228
FAX.+86-755-8291-0338
shenzhen.sales@cn.sumida.com

Singapore

Tel.+65-6296-3388
FAX.+65-6841-4426
sales@sg.sumida.com

Neumarkt

Tel.+49-9181-4509-110
FAX. +49-9181-4509-310
infocomp@eu.sumida.com

Taipei

Tel.+886-2-8751-2737
FAX.+886-2-8751-2738
sales@tw.sumida.com

San Jose

Tel.+1-408-321-9660
FAX.+1-408-321-9308
sales@us.sumida.com

X-ON Electronics

Largest Supplier of Electrical and Electronic Components

Click to view similar products for [Fixed Inductors](#) category:

Click to view products by [Sumida](#) manufacturer:

Other Similar products are found below :

[CR43NP-680KC](#) [CR54NP-820KC](#) [CR54NP-8R5MC](#) [CTX32CT-100](#) [70F224AI](#) [MGDQ4-00004-P](#) [MHL1ECTTP18NJ](#) [MHL1JCTTD12NJ](#)
[PE-51506NL](#) [PE-53601NL](#) [PE-53602NL](#) [PE-53630NL](#) [PE-53824SNLT](#) [PE-92100NL](#) [PG0434.801NLT](#) [PG0936.113NLT](#) [9310-16](#) [PM06-2N7](#) [PM06-39NJ](#) [A01TK](#) [1206CS-471XJ](#) [HC2-2R2TR](#) [HC2LP-R47-R](#) [HC3-2R2-R](#) [1206CS-151XG](#) [RCH664NP-140L](#) [RCH664NP-4R7M](#)
[RCH8011NP-221L](#) [RCP1317NP-332L](#) [RCP1317NP-391L](#) [RCR1010NP-470M](#) [RCR110DNP-331L](#) [DH2280-4R7M](#) [DS1608C-106](#) [ASPI-4020HI-R10M-T](#) [B10TJ](#) [B82477P4333M](#) [B82498B3101J000](#) [B82498B3680J000](#) [ELJ-RE27NJF2](#) [1812CS-153XJ](#) [1812CS-183XJ](#) [1812CS-223XJ](#) [1812LS-104XJ](#) [1812LS-105XJ](#) [1812LS-124XJ](#) [1812LS-154XJ](#) [1812LS-223XJ](#) [1812LS-224XJ](#) [1812LS-563XJ](#)