

# SMD Power Inductor

## CDRH5D28RB/H125



Recommended Type

### Description

- Ferrite drum core construction
- Magnetically shielded
- LxWxH: 6.5x6.2 x3.0 mm Max.
- Product weight:0.35g(Ref.)
- Moisture Sensitivity Level: 1
- Qualification to AEC-Q200



### Environmental Data

- Operating Temperature: -40°C to +125°C (including self-heating)
- Storage temperature range: -40°C~+125°C

### Packaging

- Carrier tape and reel packaging

### Applications

- High temp and high reliability automotive applications

### Dimension - [mm]

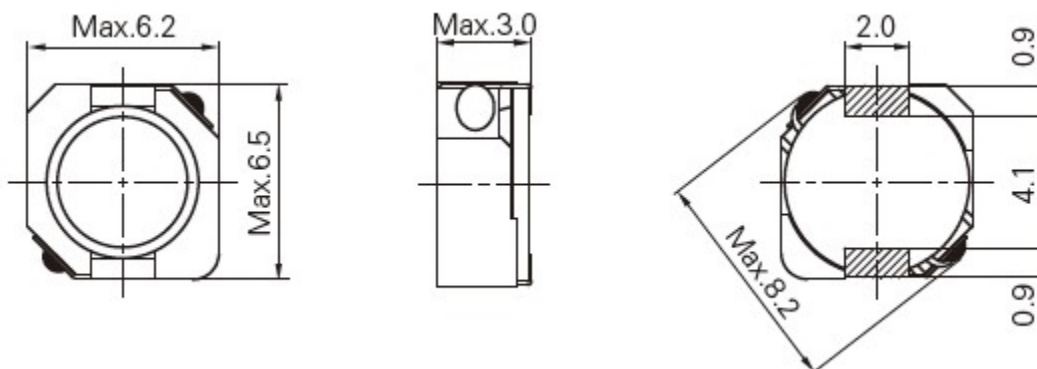

### Recommended Land pattern - [mm]

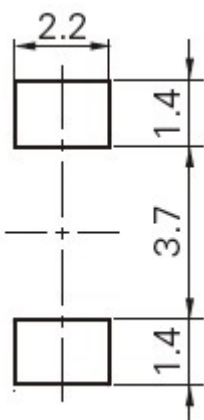

### Wire Connection

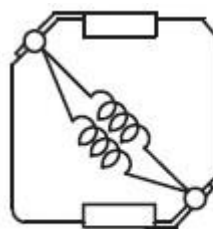

(1.0µH - 10µH)

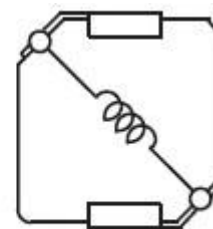

(15µH - 100µH)

# SMD Power Inductor

## CDRH5D28RB/H125



Recommended Type

### Electrical Characteristics

Part Number	Inductance [Within] ( $\mu$ H) ※1	D.C.R. at 20°C Max.(Typ.) (m $\Omega$ )	Saturation Current (A) Max.(Typ.) ※2	Temperature Rise Current (A) Max.(Typ.) ※3
CDRH5D28RBH125NP-1R0PC	1.00 $\pm$ 25%	17.00 (13.50)	7.10 (9.00)	4.10 (4.70)
CDRH5D28RBH125NP-1R4PC	1.40 $\pm$ 25%	20.00 (16.00)	6.50 (7.55)	3.60 (4.15)
CDRH5D28RBH125NP-1R8PC	1.80 $\pm$ 25%	22.50 (18.00)	5.70 (6.60)	3.40 (4.00)
CDRH5D28RBH125NP-2R4PC	2.40 $\pm$ 25%	27.00 (21.50)	5.30 (5.90)	3.20 (3.65)
CDRH5D28RBH125NP-3R3PC	3.30 $\pm$ 25%	35.50 (28.50)	4.30 (4.85)	2.72 (3.10)
CDRH5D28RBH125NP-4R7PC	4.70 $\pm$ 25%	54.00 (43.00)	3.70 (4.18)	2.20 (2.50)
CDRH5D28RBH125NP-6R8PC	6.80 $\pm$ 25%	77.50 (62.00)	3.08 (3.42)	1.80 (2.00)
CDRH5D28RBH125NP-100MC	10.00 $\pm$ 20%	121 (97.00)	2.46 (2.78)	1.40 (1.58)
CDRH5D28RBH125NP-150MC	15.00 $\pm$ 20%	148 (118)	2.08 (2.32)	1.24 (1.40)
CDRH5D28RBH125NP-220MC	22.00 $\pm$ 20%	266 (213)	1.70 (1.88)	0.90 (1.10)
CDRH5D28RBH125NP-330MC	33.00 $\pm$ 20%	334 (267)	1.41 (1.59)	0.80 (0.92)
CDRH5D28RBH125NP-470MC	47.00 $\pm$ 20%	500 (400)	1.16 (1.32)	0.64 (0.73)
CDRH5D28RBH125NP-680MC	68.00 $\pm$ 20%	685 (548)	0.95 (1.11)	0.54 (0.62)
CDRH5D28RBH125NP-101MC	100 $\pm$ 20%	1020 (815)	0.80 (0.90)	0.46 (0.53)

※1. Inductance measuring condition: at 100kHz.

※2. Saturation current: The value of D.C. current when the inductance decreases to 65% of its nominal value.

※3. Temperature rise current: The value of D.C. current when the temperature rise is  $\Delta t=40^{\circ}\text{C}$  ( $T_a=20^{\circ}\text{C}$ ).

### Solder Reflow Condition

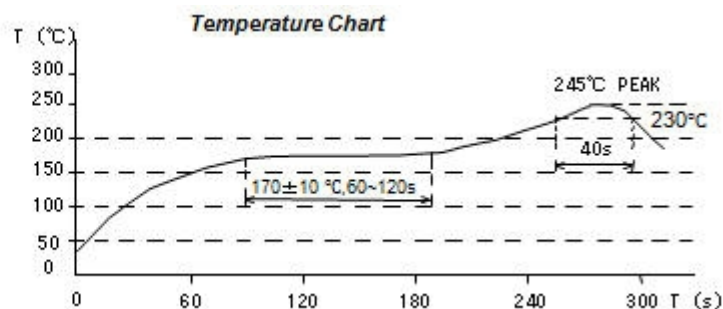
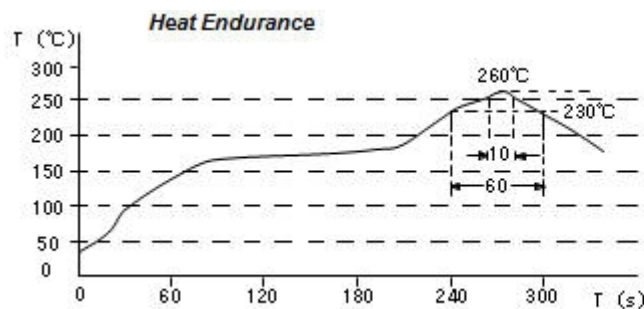

# SMD Power Inductor

## CDRH5D28RB/H125



Recommended Type

### Saturation Current & Temperature Rise Graph

— L (20°C) — L (125°C) —  $\Delta T$

1. CDRH5D28RBH125NP-1R0PC

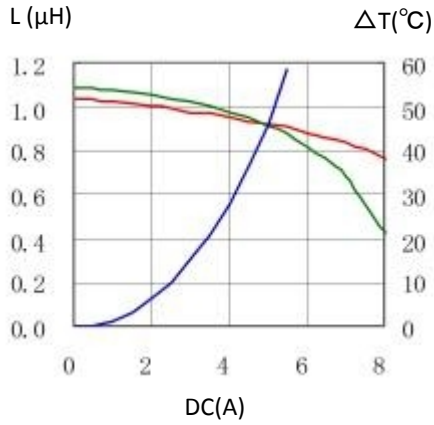

2. CDRH5D28RBH125NP-1R4PC

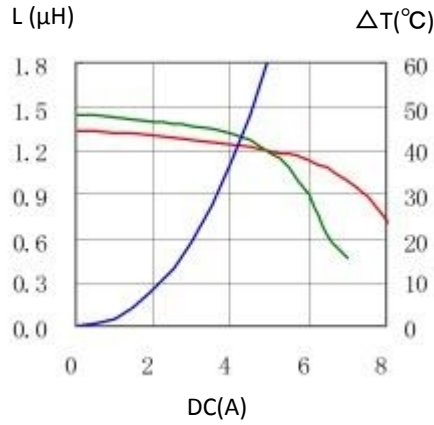

3. CDRH5D28RBH125NP-1R8PC

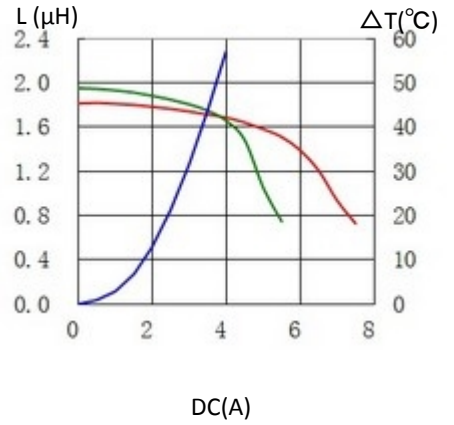

4. CDRH5D28RBH125NP-2R4PC

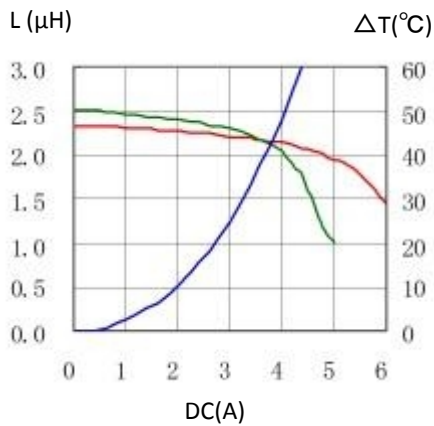

5. CDRH5D28RBH125NP-3R3PC

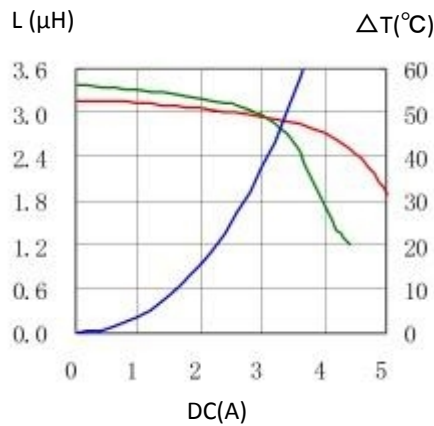

6. CDRH5D28RBH125NP-4R7PC

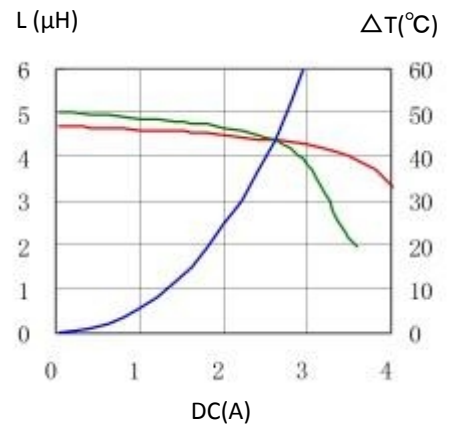

7. CDRH5D28RBH125NP-6R8PC

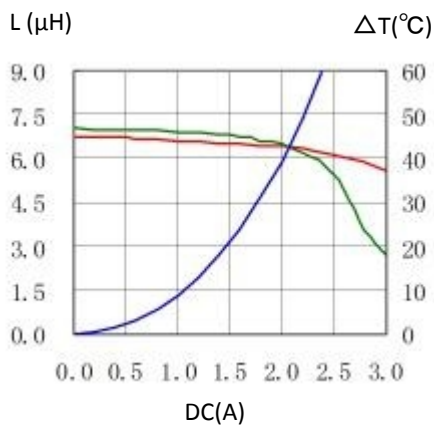

8. CDRH5D28RBH125NP-100MC

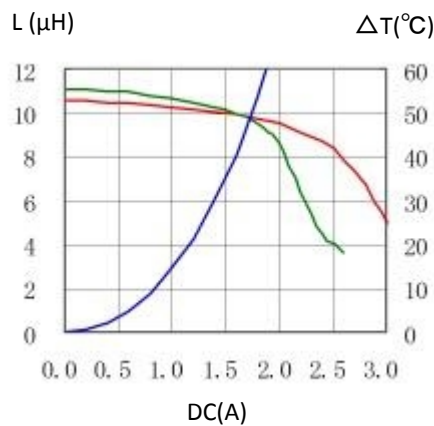

9. CDRH5D28RBH125NP-150MC

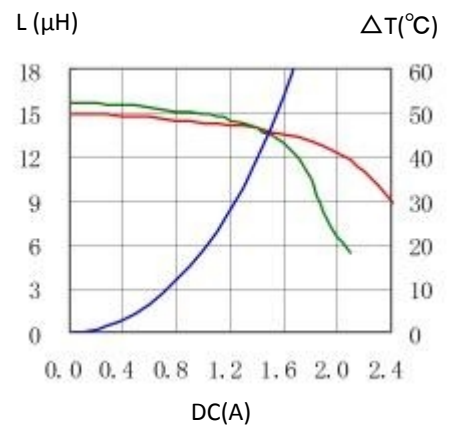

Note: This specification is subject to change without notice. Please contact your nearest sales office for updated information when placing an order.

# SMD Power Inductor

## CDRH5D28RB/H125



10. CDRH5D28RBH125NP-220MC

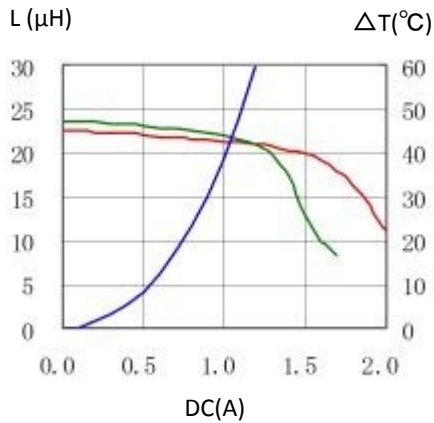

11. CDRH5D28RBH125NP-330MC

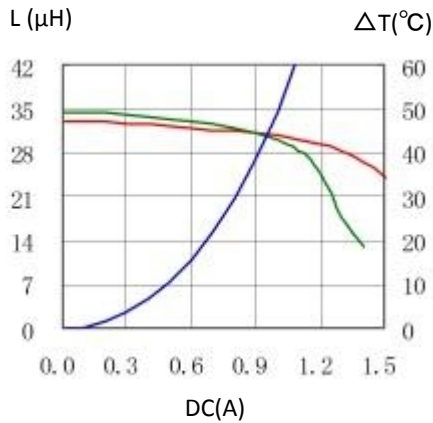

12. CDRH5D28RBH125NP-470MC

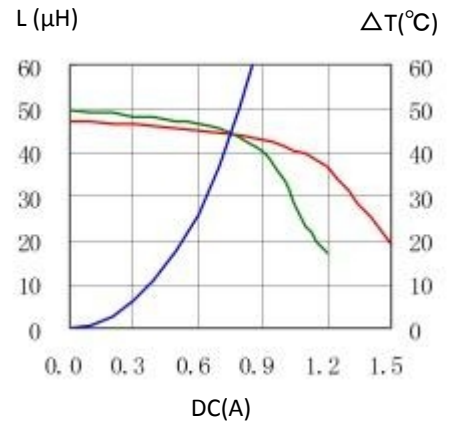

13. CDRH5D28RBH125NP-680MC

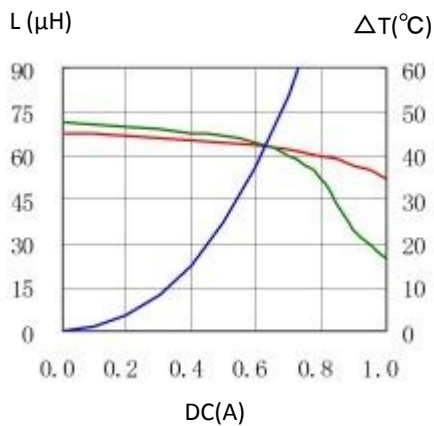

14. CDRH5D28RBH125NP-101MC

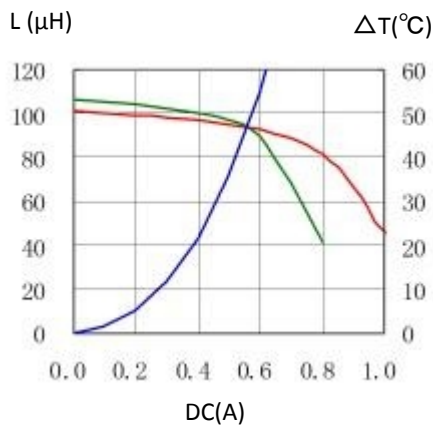

For sales office information, please [click here](#) to visit our website.

## X-ON Electronics

Largest Supplier of Electrical and Electronic Components

*Click to view similar products for [Power Inductors - SMD category](#):*

*Click to view products by [Sumida manufacturer](#):*

Other Similar products are found below :

[SPD62R-472M](#) [LLQPB201214T1R0M](#) [LLXND3030QKT470MNG](#) [LLQPB160807T4R7M](#) [LLAPB2016KKTR33M](#)  
[LBXND4040TKL330MDG](#) [LLXNE3030KKT4R7MN](#) [LSQEA201212T100M](#) [IHLP5050CEER4R7M06](#) [LVS505020-1R0T-N](#) [LVS505040-1R2T-N](#) [LVS606020-1R5M-N](#) [LVS606028-6R8M-N](#) [LVS606045-102M-N](#) [LVS606045-150M-N](#) [LVS606045-1R8M-N](#) [LVS606045-6R8M-N](#) [LVS808040-2R0M-N](#) [LVS808040-330M-N](#) [LVS808040-4R7M-N](#) [MHCI06030-R56M-R8](#) [SCD0403T-470M-N](#) [SCD0403T-6R8K-N](#) [SCD0504T-101M-N](#) [SCD0504T-120M-N](#) [SCD0504T-221M-N](#) [SCD0504T-470M-N](#) [SCD0504T-471M-N](#) [SCD0705T-180M-N](#) [SCD0705T-221M-N](#) [SCD0705T-470M-N](#) [SCD1005T-101M-N](#) [SCD1005T-221M-N](#) [SCD1005T-470M-N](#) [SSL1306T-101M-N](#) [LQB15NNR27K10D](#) [201610CDMCDDS-R47MC](#) [201610CDMCDDS-1R0MC](#) [201610CDMCDDS-R68MC](#) [LSQPB201210T220M](#) [LBCNF2012KKTR24MA](#) [LSQEA201212T220K](#) [LSENC2016KKT1R0M](#) [LSBHB1608KKT2R2MG](#) [LSQPB160807T2R2M](#) [LSQEA201212T101K](#) [LCXND4040MKL4R7MDG](#) [DEM8045Z-5R6N=P3](#) [LCXNH8080YKL101MJG](#) [LSCNA2012KKT1R0MA](#)