

# SMD Power Inductor CDRH5D28R/H125



## Description

- Ferrite drum core construction.
- Magnetically shielded.
- L × W × H: 6.3 × 6.2 × 3.0 mm Max.
- Product weight: 0.35g (Ref.)
- Moisture Sensitivity Level: 1
- RoHS compliance.
- Qualification to AEC-Q200.

## Dimension - [mm]

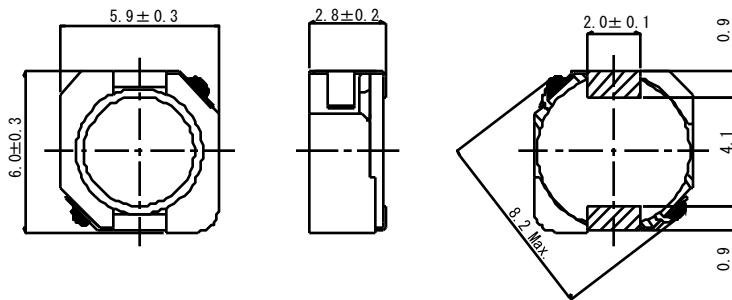

## Land pattern and Schematics - [mm]

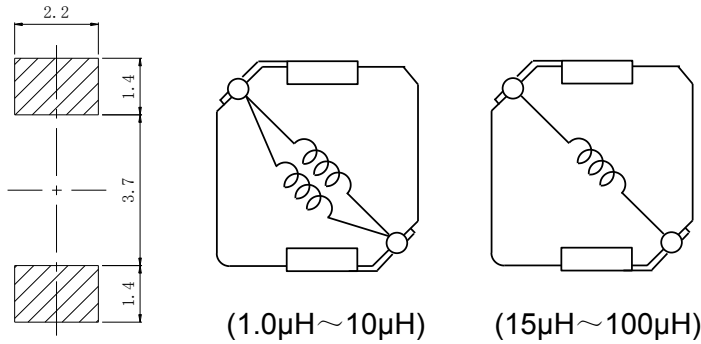

## Environmental Data

- Operating temperature range: -40°C ~ +125°C (including coil's self temperature rise)
- Storage temperature range: -40°C ~ +125°C
- Solder reflow temperature: 260 °C peak.

## Packaging

- Carrier tape and reel packaging
- 13.0" diameter reel
- 2000 pcs per reel

## Applications

- Automotive and other high temperature, high reliability application.

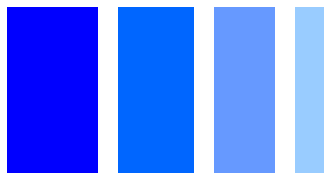

### Electrical Characteristics

Part No.	Stamp	Inductance [μH] 100kHz	D.C.R. (mΩ) [Max.] (at 20°C)	Saturation current (A) ※1		Temperature rise current (A)※2
				(at20°C)	(at125°C) Typ.	
CDRH5D28RH125NP-1R0PC	1R0	1.0±25%	17.0(13.5)	7.10	5.60	4.10
CDRH5D28RH125NP-1R5PC	1R5	1.5±25%	20.0(16.0)	6.50	5.10	3.60
CDRH5D28RH125NP-2R4PC	2R4	2.4±25%	27.0(21.5)	5.30	4.00	3.20
CDRH5D28RH125NP-3R3PC	3R3	3.3±25%	35.5(28.5)	4.30	3.40	2.72
CDRH5D28RH125NP-4R7PC	4R7	4.7±25%	54.0(43.0)	3.70	2.89	2.20
CDRH5D28RH125NP-6R8PC	6R8	6.8±25%	77.5(62.0)	3.08	2.44	1.80
CDRH5D28RH125NP-100MC	100	10±20%	121(97.0)	2.46	1.93	1.40
CDRH5D28RH125NP-150MC	150	15±20%	148(118)	2.08	1.63	1.24
CDRH5D28RH125NP-220MC	220	22±20%	266(213)	1.70	1.33	0.90
CDRH5D28RH125NP-330MC	330	33±20%	334(267)	1.41	1.12	0.80
CDRH5D28RH125NP-470MC	470	47±20%	500(400)	1.16	0.91	0.64
CDRH5D28RH125NP-680MC	680	68±20%	685(548)	0.95	0.74	0.54
CDRH5D28RH125NP-101MC	101	100±20%	1020(815)	0.80	0.62	0.46

※1. Saturation current: The value of D.C. current when the inductance decreases to 65% of its nominal value.

※2. Temperature rise current: The value of D.C. current when the temperature rise is  $\Delta t=40^{\circ}\text{C}$  ( $T_a=20^{\circ}\text{C}$ ).

# SMD Power Inductor CDRH5D28R/H125

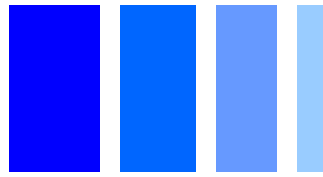

## Saturation Current & Temperature Rise Graph

— L (20°C) — L (125°C) —  $\Delta T$

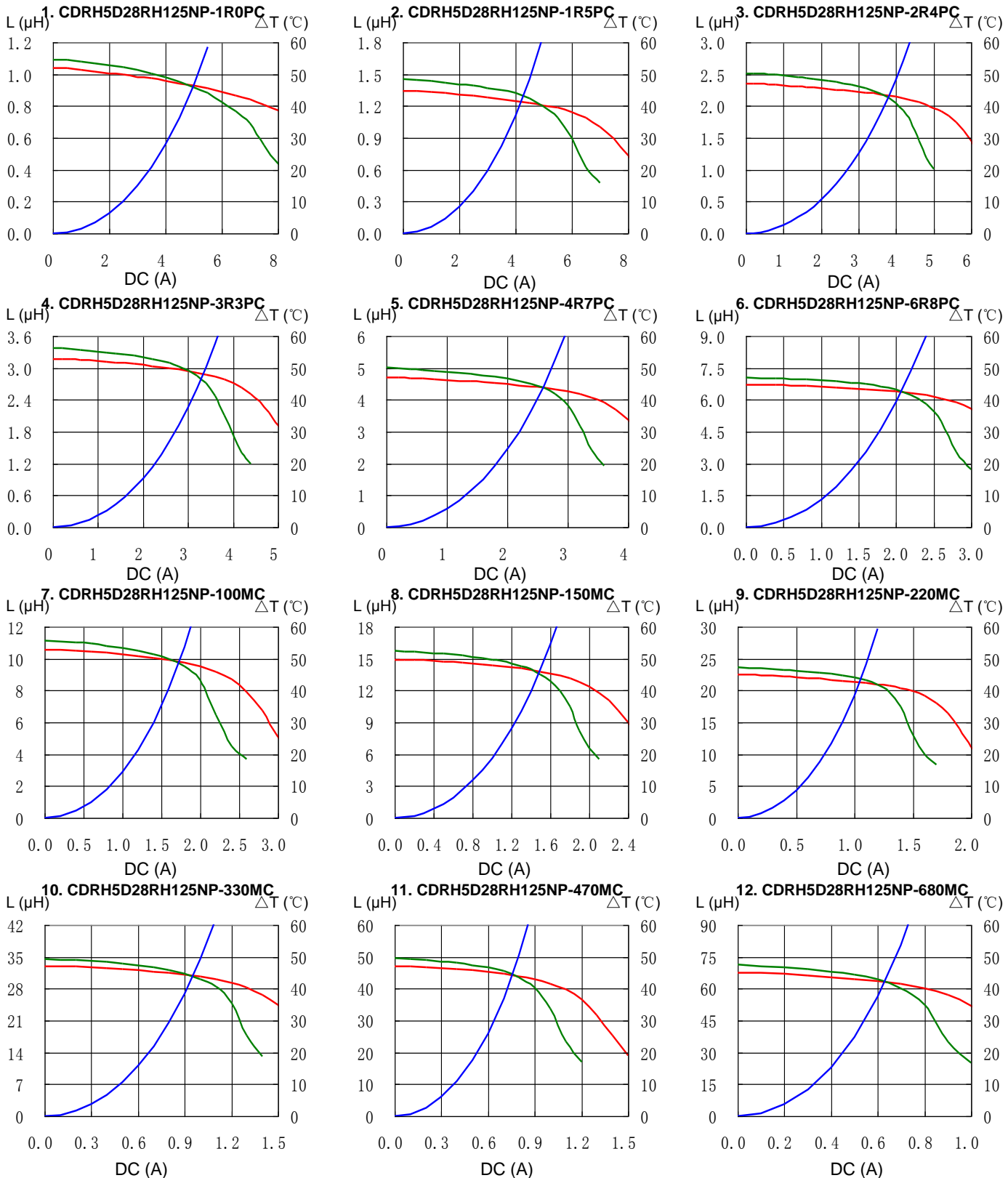

# SMD Power Inductor CDRH5D28R/H125



## Saturation Current & Temperature Rise Graph

— L (20°C) — L (125°C) —  $\Delta T$

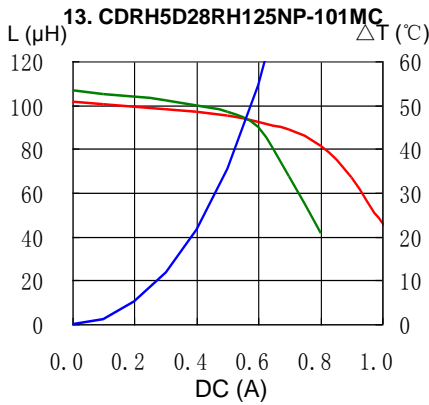

## Solder Reflow Condition

Heat Endurance

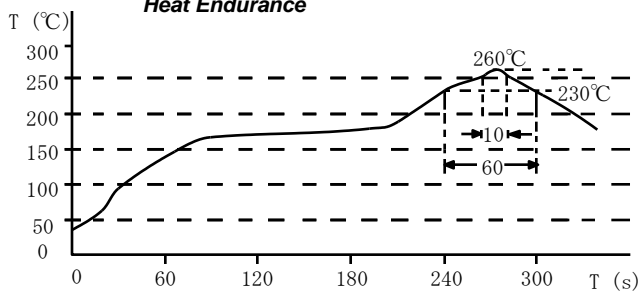

Temperature Chart

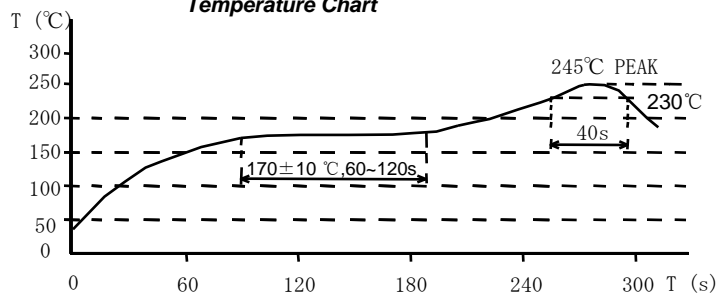

Please refer to the sales offices on our website - <http://www.sumida.com>

### Hong Kong

Tel.+852-2880-6781  
FAX.+852-2565-9600  
[sales@hk.sumida.com](mailto:sales@hk.sumida.com)

### Saitama(Japan)

Tel.+81-48-691-7300  
FAX.+81-48-691-7340  
[sales@jp.sumida.com](mailto:sales@jp.sumida.com)

### Chicago

Tel.+1-847-545-6700  
FAX. +1-847-545-6720  
[sales@us.sumida.com](mailto:sales@us.sumida.com)

### Shanghai

Tel.+86-21-5836-3299  
FAX.+86-21-5836-3266  
[shanghai.sales@cn.sumida.com](mailto:shanghai.sales@cn.sumida.com)

### Seoul

Tel.+82-2-6237-0777  
FAX.+82-2-6237-0778  
[sales@kr.sumida.com](mailto:sales@kr.sumida.com)

### Obernzell

Tel.+49-8591-937-0  
FAX. +49-8591-937-103  
[contact@eu.sumida.com](mailto:contact@eu.sumida.com)

### Shenzhen

Tel.+86-755-8291-0228  
FAX.+86-755-8291-0338  
[shenzhen.sales@cn.sumida.com](mailto:shenzhen.sales@cn.sumida.com)

### Singapore

Tel.+65-6296-3388  
FAX.+65-6841-4426  
[sales@sg.sumida.com](mailto:sales@sg.sumida.com)

### Neumarkt

Tel.+49-9181-4509-110  
FAX. +49-9181-4509-310  
[infocomp@eu.sumida.com](mailto:infocomp@eu.sumida.com)

### Taipei

Tel.+886-2-8751-2737  
FAX.+886-2-8751-2738  
[sales@tw.sumida.com](mailto:sales@tw.sumida.com)

### San Jose

Tel.+1-408-321-9660  
FAX.+1-408-321-9308  
[sales@us.sumida.com](mailto:sales@us.sumida.com)

## X-ON Electronics

Largest Supplier of Electrical and Electronic Components

*Click to view similar products for [Fixed Inductors](#) category:*

*Click to view products by [Sumida](#) manufacturer:*

Other Similar products are found below :

[CR43NP-680KC](#) [CR54NP-820KC](#) [CR54NP-8R5MC](#) [CTX32CT-100](#) [70F224AI](#) [MGDQ4-00004-P](#) [MHL1ECTTP18NJ](#) [MHL1JCTTD12NJ](#)  
[PE-51506NL](#) [PE-53601NL](#) [PE-53602NL](#) [PE-53630NL](#) [PE-53824SNLT](#) [PE-62892NL](#) [PE-92100NL](#) [PG0434.801NLT](#) [PG0936.113NLT](#)  
[9310-16](#) [PM06-2N7](#) [PM06-39NJ](#) [A01TK](#) [1206CS-471XJ](#) [HC2-2R2TR](#) [HC2LP-R47-R](#) [HC3-2R2-R](#) [1206CS-151XG](#) [RCH664NP-140L](#)  
[RCH664NP-4R7M](#) [RCH8011NP-221L](#) [RCP1317NP-332L](#) [RCP1317NP-391L](#) [RCR1010NP-470M](#) [RCR110DNP-331L](#) [DH2280-4R7M](#)  
[DS1608C-106](#) [ASPI-4020HI-R10M-T](#) [B10TJ](#) [B82477P4333M](#) [B82498B3101J000](#) [B82498B3680J000](#) [ELJ-RE27NJF2](#) [1812CS-153XJ](#)  
[1812CS-183XJ](#) [1812CS-223XJ](#) [1812LS-104XJ](#) [1812LS-105XJ](#) [1812LS-124XJ](#) [1812LS-154XJ](#) [1812LS-223XJ](#) [1812LS-224XJ](#)