

SMD Power Inductor CDRH8D43R/T125



Description

- Ferrite drum core construction.
- Magnetically shielded.
- L × W × H: 8.5 × 8.3 × 4.5 mm Max.
- Product weight: 1.0g(Ref.)
- Moisture Sensitivity Level: 1
- RoHS compliance.

Environmental Data

- Operating temperature range: -40°C ~ +125°C (including coil's self temperature rise)
- Storage temperature range: -40°C ~ +125°C
- Solder reflow temperature: 260 °C peak.

Packaging

- Carrier tape and reel packaging
- 13.0" diameter reel
- 500pcs per reel

Applications

- Automotive and other high temperature, high reliability application.

Dimension - [mm]

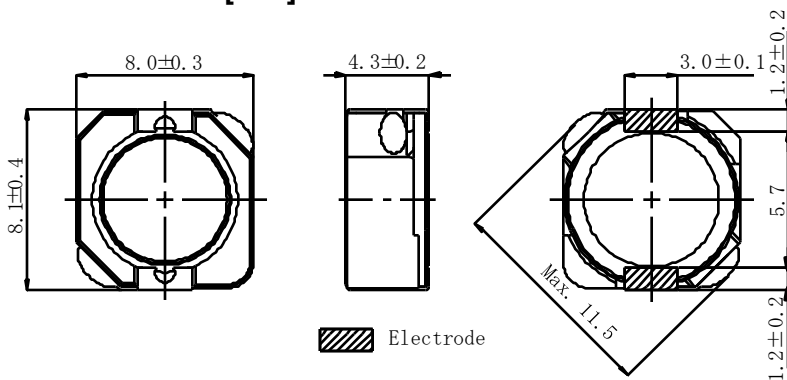

Land pattern and Schematics - [mm]

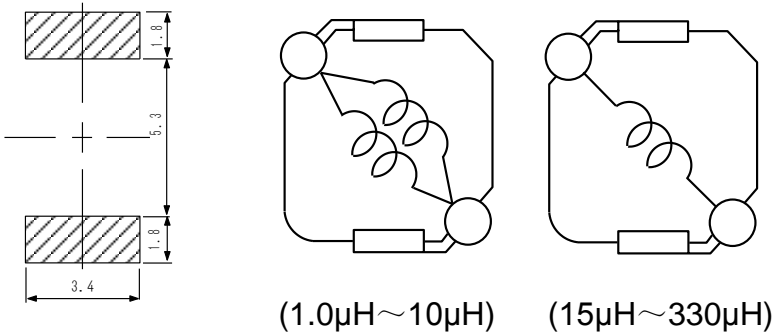



Electrical Characteristics

Part No.	Stamp	Inductance (μ H) [Within] ※1	D.C.R. (m Ω) [Max.] (at 20°C) ※2	Saturation current (A) ※3		Temperature rise current (A) ※4
				(at 20°C)	(at 125°C) (Typ.)	
CDRH8D43RT125NP-1R0NC	1R0	1.0 \pm 30%	9.7(7.8)	8.00	6.00	7.50
CDRH8D43RT125NP-1R8NC	1R8	1.8 \pm 30%	12.1(9.7)	7.30	5.80	6.40
CDRH8D43RT125NP-2R4NC	2R4	2.4 \pm 30%	14.0(11.2)	7.10	5.60	5.80
CDRH8D43RT125NP-3R3NC	3R3	3.3 \pm 30%	16.3(13.0)	6.10	4.70	5.20
CDRH8D43RT125NP-4R3NC	4R3	4.3 \pm 30%	23.5(18.8)	5.40	4.20	4.30
CDRH8D43RT125NP-5R6NC	5R6	5.6 \pm 30%	26.9(21.5)	4.50	3.50	3.70
CDRH8D43RT125NP-6R8NC	6R8	6.8 \pm 30%	29.8(23.9)	4.20	3.30	3.45
CDRH8D43RT125NP-8R2NC	8R2	8.2 \pm 30%	40.8(32.6)	4.00	3.20	2.85
CDRH8D43RT125NP-100MC	100	10 \pm 20%	45.0(36.0)	3.50	2.75	2.70
CDRH8D43RT125NP-150MC	150	15 \pm 20%	61.8(49.4)	2.90	2.30	2.30
CDRH8D43RT125NP-220MC	220	22 \pm 20%	77.6(62.0)	2.35	1.85	2.05
CDRH8D43RT125NP-330MC	330	33 \pm 20%	123(98.5)	1.95	1.55	1.55
CDRH8D43RT125NP-470MC	470	47 \pm 20%	186(149)	1.60	1.30	1.30
CDRH8D43RT125NP-680MC	680	68 \pm 20%	288(231)	1.30	1.05	1.03
CDRH8D43RT125NP-101MC	101	100 \pm 20%	353(282)	1.10	0.87	0.93
CDRH8D43RT125NP-151MC	151	150 \pm 20%	575(460)	0.91	0.72	0.76
CDRH8D43RT125NP-221MC	221	220 \pm 20%	861(689)	0.75	0.60	0.60
CDRH8D43RT125NP-331MC	331	330 \pm 20%	1330(1068)	0.62	0.50	0.48

※ 1 Measuring frequency inductance at 100kHz.

※ 2 () are typical value.

※ 3 Saturation current: The value of D.C. current when the inductance decreases to 65% of it's nominal value.

※ 4 Temperature rise current: The value of D.C. current when the temperature rise is $\Delta t=40^{\circ}\text{C}$ ($T_a=20^{\circ}\text{C}$).

SMD Power Inductor CDRH8D43R/T125

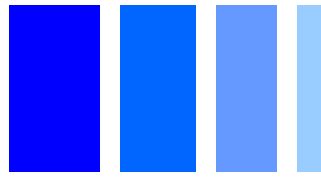

Saturation Current & Temperature Rise Graph

— L (20°C) — L (125°C) — ΔT

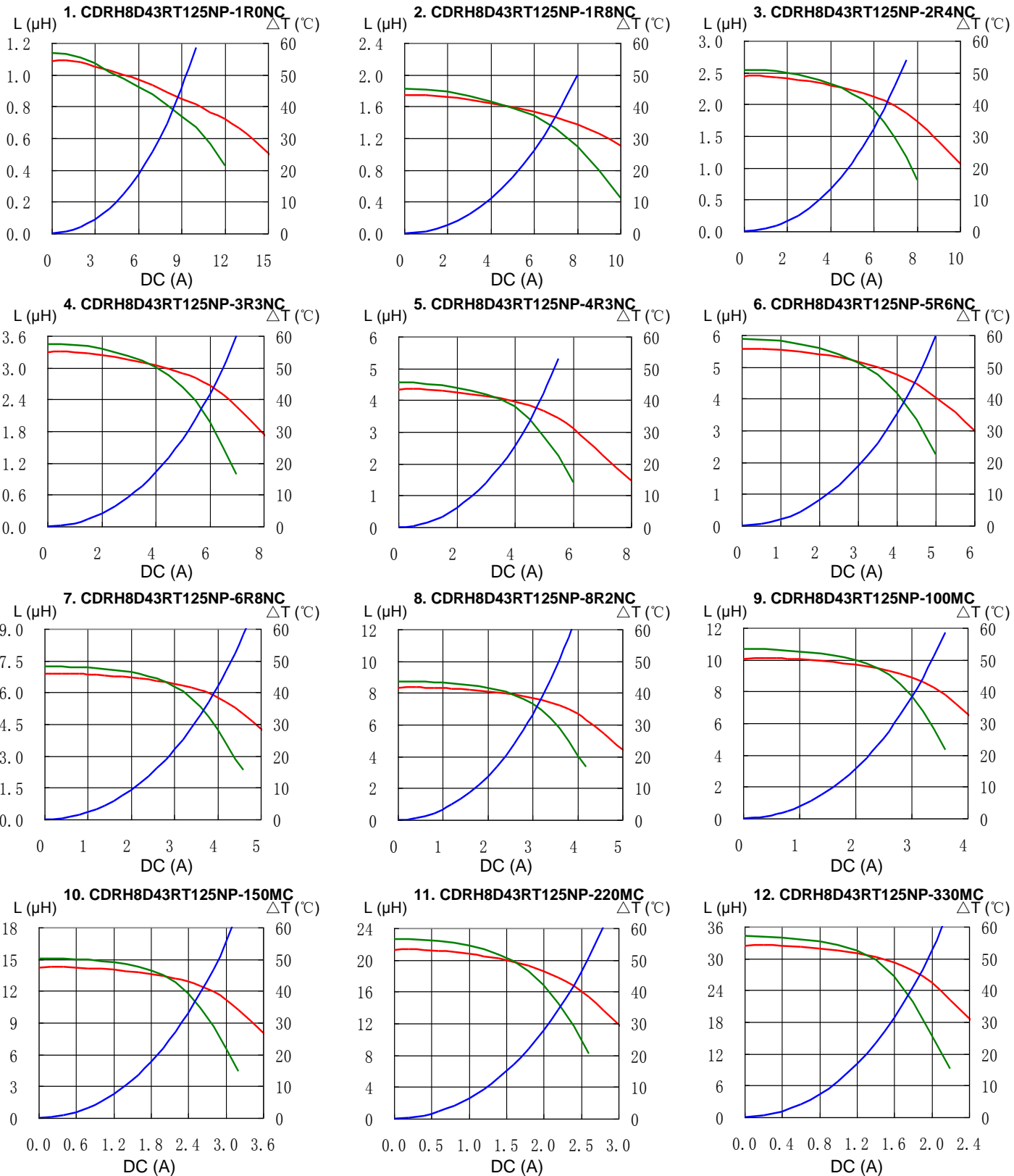

SMD Power Inductor CDRH8D43R/T125



Saturation Current & Temperature Rise Graph

— L (20°C) — L (125°C) — ΔT

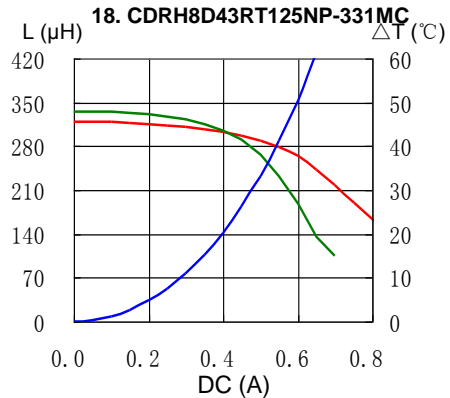
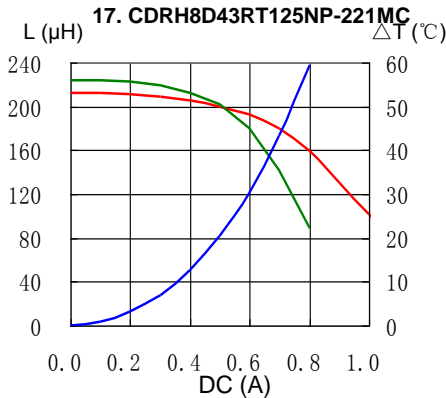
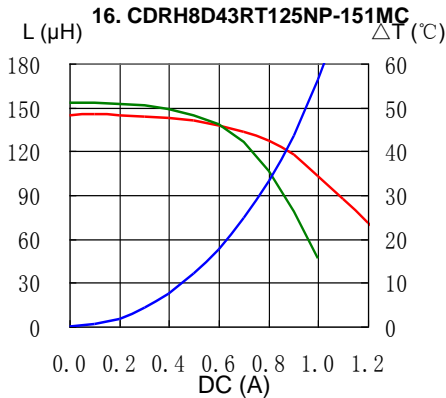
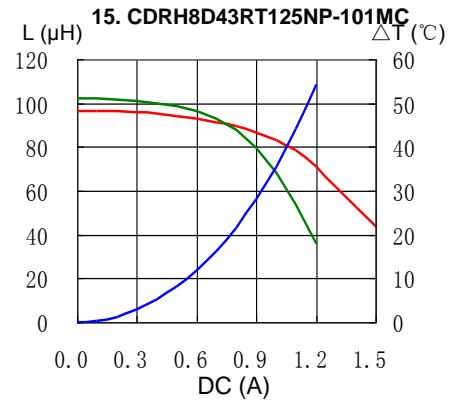
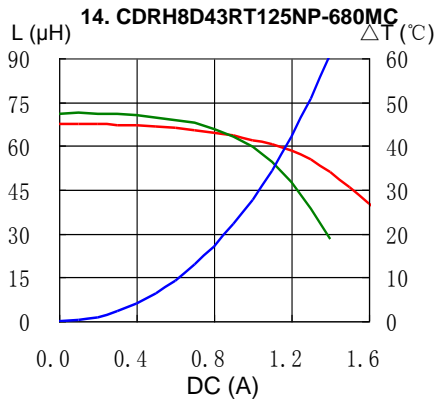
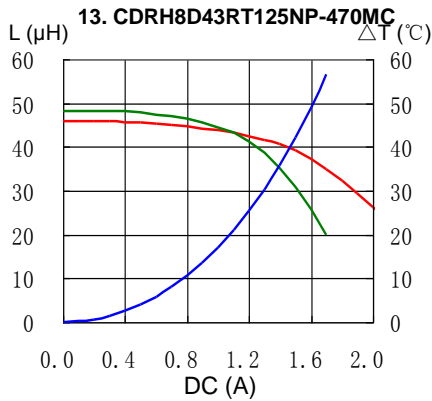

Solder Reflow Condition

Heat Endurance

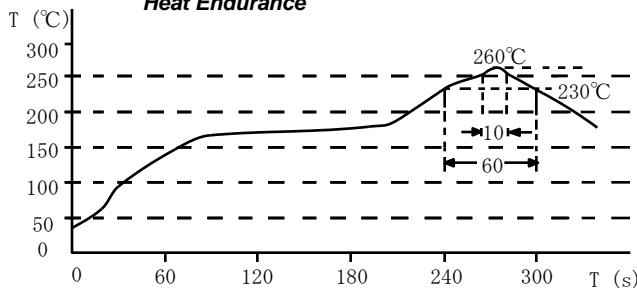

Temperature Chart

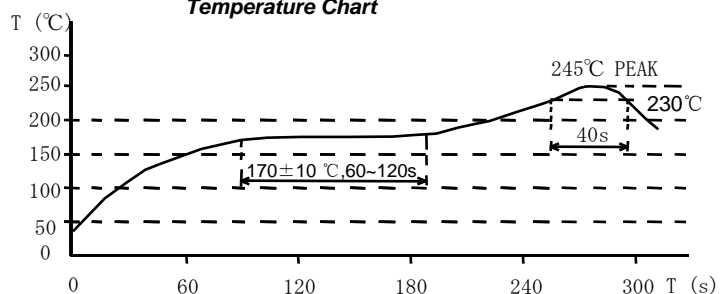

Please refer to the sales offices on our website - <http://www.sumida.com>

Hong Kong

Tel.+852-2880-6781
FAX.+852-2565-9600
sales@hk.sumida.com

Saitama(Japan)

Tel.+81-48-691-7300
FAX.+81-48-691-7340
sales@jp.sumida.com

Chicago

Tel.+1-847-545-6700
FAX. +1-847-545-6720
sales@us.sumida.com

Shanghai

Tel.+86-21-5836-3299
FAX.+86-21-5836-3266
shanghai.sales@cn.sumida.com

Seoul

Tel.+82-2-6237-0777
FAX.+82-2-6237-0778
sales@kr.sumida.com

Obernzell

Tel.+49-8591-937-0
FAX. +49-8591-937-103
contact@eu.sumida.com

Shenzhen

Tel.+86-755-8291-0228
FAX.+86-755-8291-0338
shenzhen.sales@cn.sumida.com

Singapore

Tel.+65-6296-3388
FAX.+65-6841-4426
sales@sg.sumida.com

Neumarkt

Tel.+49-9181-4509-110
FAX. +49-9181-4509-310
infocomp@eu.sumida.com

Taipei

Tel.+886-2-8751-2737
FAX.+886-2-8751-2738
sales@tw.sumida.com

San Jose

Tel.+1-408-321-9660
FAX.+1-408-321-9308
sales@us.sumida.com

X-ON Electronics

Largest Supplier of Electrical and Electronic Components

Click to view similar products for [Fixed Inductors](#) category:

Click to view products by [Sumida](#) manufacturer:

Other Similar products are found below :

[CR32NP-100KC](#) [CR32NP-151KC](#) [CR32NP-180KC](#) [CR32NP-181KC](#) [CR32NP-1R5MC](#) [CR32NP-390KC](#) [CR32NP-3R9MC](#) [CR32NP-680KC](#) [CR32NP-820KC](#) [CR32NP-8R2MC](#) [CR43NP-390KC](#) [CR43NP-560KC](#) [CR43NP-680KC](#) [CR54NP-181KC](#) [CR54NP-470LC](#) [CR54NP-820KC](#) [CR54NP-8R5MC](#) [70F224AI](#) [MGDQ4-00004-P](#) [MHL1ECTTP18NJ](#) [MHQ1005P10NJ](#) [MHQ1005P1N0S](#) [MHQ1005P2N4S](#) [MHQ1005P3N6S](#) [MHQ1005P5N1S](#) [MHQ1005P8N2J](#) [PE-51506NL](#) [PE-53601NL](#) [PE-53602NL](#) [PE-53630NL](#) [PE-53824SNLT](#) [PE-92100NL](#) [PG0434.801NLT](#) [PG0936.113NLT](#) [9220-20](#) [9310-16](#) [PM06-2N7](#) [PM06-39NJ](#) [A01TK](#) [1206CS-471XJ](#) [HC2LP-R47-R](#) [HC2-R47-R](#) [HC3-2R2-R](#) [HCF1305-3R3-R](#) [1206CS-151XG](#) [RCH664NP-140L](#) [RCH664NP-4R7M](#) [RCH8011NP-221L](#) [RCP1317NP-332L](#) [RCP1317NP-391L](#)