

SMD Power Inductor CDRH8D48/A



Description

- Ferrite drum core construction.
- Magnetically shielded.
- L × W × H: 8.5 × 8.5 × 5.0 mm Max.
- Product weight: 1.1g(Ref.)
- Moisture Sensitivity Level: 1
- RoHS compliance.
- Qualification to AEC-Q200.

Environmental Data

- Operating temperature range: -40°C ~ +125°C (including coil's self temperature rise).
- Storage temperature range: -40°C ~ +85°C
- Solder reflow temperature: 260 °C peak.

Packaging

- Carrier tape and reel packaging
- 14.5" diameter reel
- 1000pcs per reel

Applications

- Automotive and other high temperature, high reliability application.

Dimension - [mm]

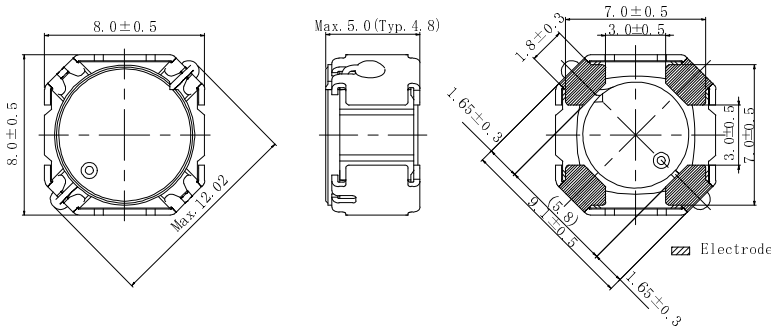

Land pattern and Schematics - [mm]

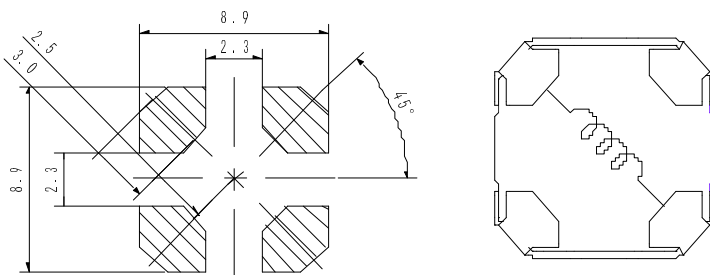

SMD Power Inductor CDRH8D48/A



Electrical Characteristics

Part No.	Stamp	Inductance [μ H] [Within] ※1	D.C.R. (m Ω) [Max.](Typ.) (at 20°C)	Rated current (A) (at 125°C) ※2
CDRH8D48/ANP-100MC	100	10 μ H \pm 20%	38(30)	2.26
CDRH8D48/ANP-120MC	120	12 μ H \pm 20%	50(40)	1.87
CDRH8D48/ANP-150MC	150	15 μ H \pm 20%	63(50)	1.62
CDRH8D48/ANP-180MC	180	18 μ H \pm 20%	75(60)	1.58
CDRH8D48/ANP-220MC	220	22 μ H \pm 20%	88(70)	1.45
CDRH8D48/ANP-270MC	270	27 μ H \pm 20%	106(85)	1.33
CDRH8D48/ANP-330MC	330	33 μ H \pm 20%	125(100)	1.20
CDRH8D48/ANP-390MC	390	39 μ H \pm 20%	156(125)	1.06
CDRH8D48/ANP-470MC	470	47 μ H \pm 20%	188(150)	1.00
CDRH8D48/ANP-560MC	560	56 μ H \pm 20%	238(190)	0.89
CDRH8D48/ANP-680MC	680	68 μ H \pm 20%	275(220)	0.82
CDRH8D48/ANP-820MC	820	82 μ H \pm 20%	312(250)	0.73
CDRH8D48/ANP-101MC	101	100 μ H \pm 20%	394(315)	0.70
CDRH8D48/ANP-121MC	121	120 μ H \pm 20%	438(350)	0.63
CDRH8D48/ANP-151MC	151	150 μ H \pm 20%	580(465)	0.58

※1. Inductance measuring condition: at 100 kHz.

※2. Rated current: The DC current at which the inductance decreases to 65% of its nominal value or when $\Delta t=30^{\circ}\text{C}$, whichever is lower .

SMD Power Inductor CDRH8D48/A



Saturation Current & Temperature Rise Graph

— L (20°C) — L (125°C) — ΔT

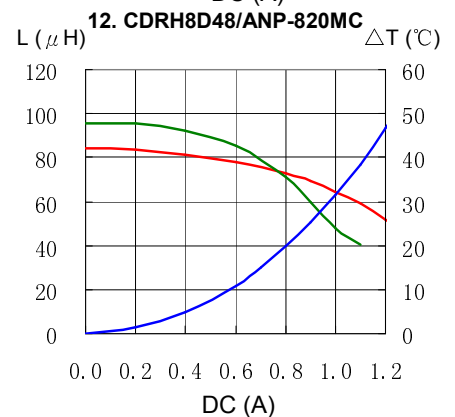
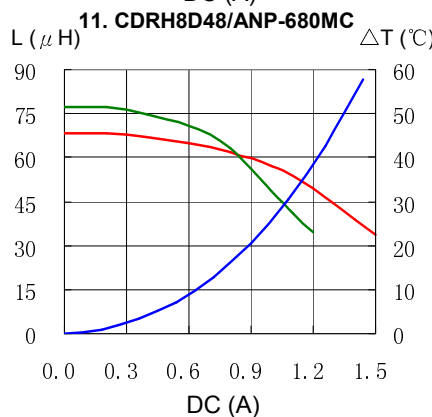
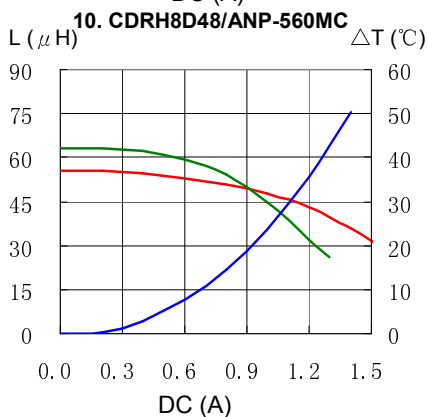
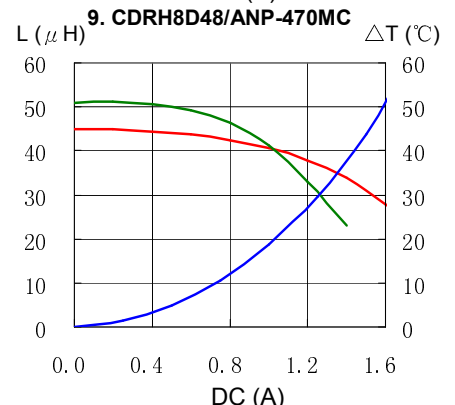
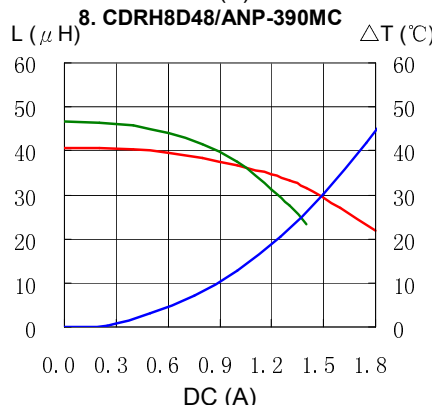
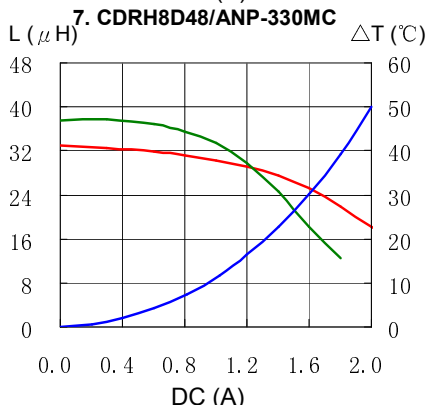
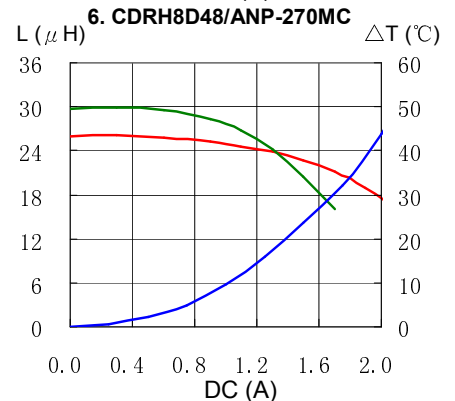
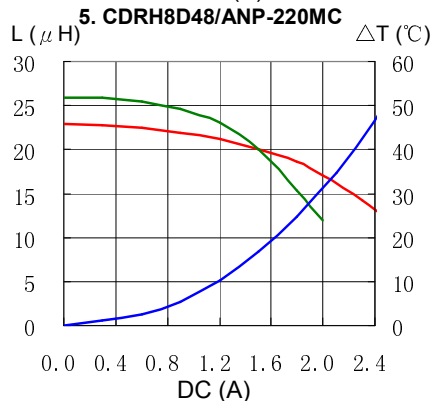
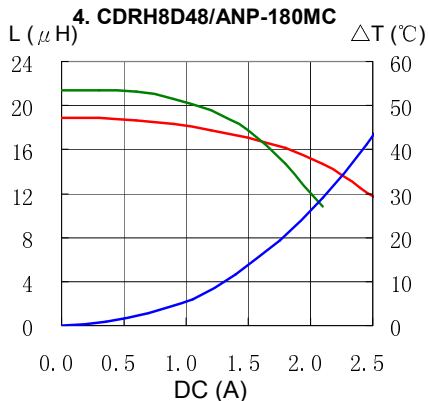
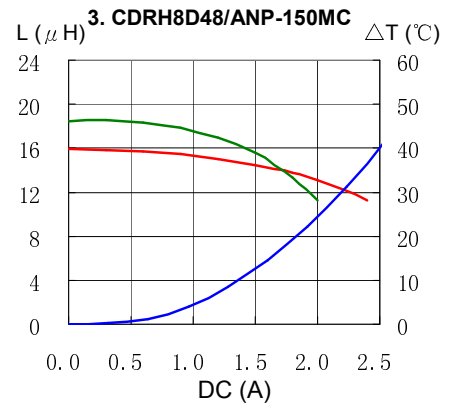
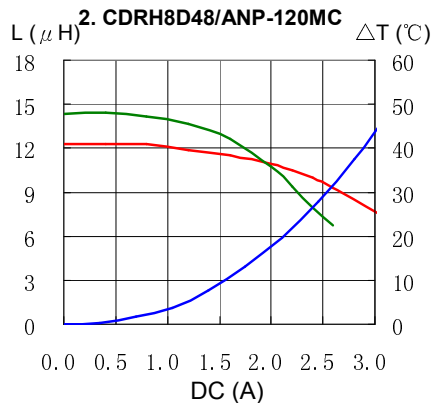
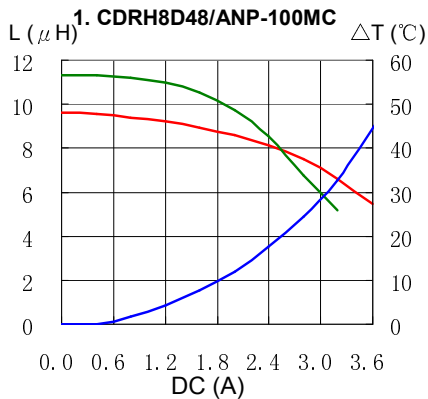

SMD Power Inductor CDRH8D48/A



Saturation Current & Temperature Rise Graph

— L (20°C) — L (125°C) — ΔT

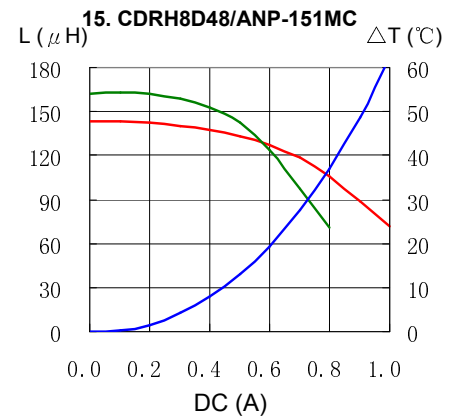
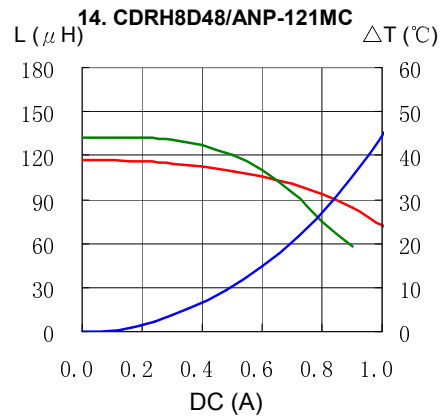
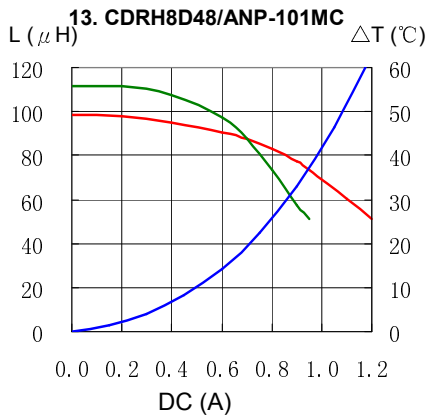

Solder Reflow Condition

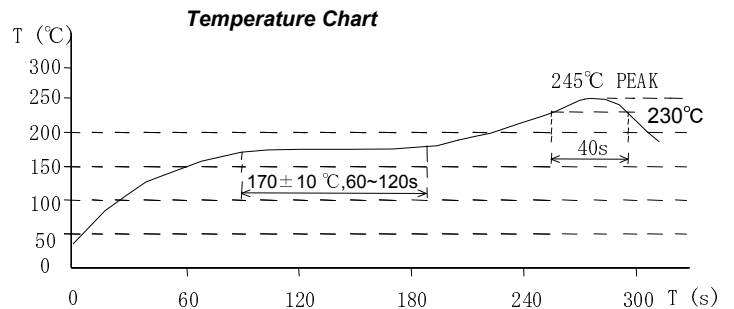
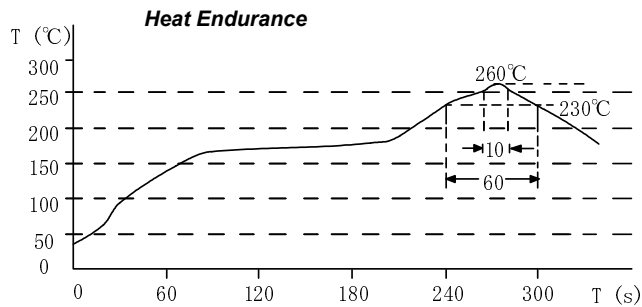

Please refer to the sales offices on our website - <http://www.sumida.com>

Hong Kong
Tel.+852-2880-6781
FAX.+852-2565-9600
sales@hk.sumida.com

Saitama(Japan)
Tel.+81-48-691-7300
FAX.+81-48-691-7340
sales@jp.sumida.com

Chicago
Tel.+1-847-545-6700
FAX. +1-847-545-6720
sales@us.sumida.com

Shanghai
Tel.+86-21-5836-3299
FAX.+86-21-5836-3266
shanghai.sales@cn.sumida.com

Seoul
Tel.+82-2-6237-0777
FAX.+82-2-6237-0778
sales@kr.sumida.com

Oberzell
Tel.+49-8591-937-0
FAX. +49-8591-937-103
contact@eu.sumida.com

Shenzhen
Tel.+86-755-8291-0228
FAX.+86-755-8291-0338
shenzhen.sales@cn.sumida.com

Singapore
Tel.+65-6296-3388
FAX.+65-6841-4426
sales@sg.sumida.com

Neumarkt
Tel.+49-9181-4509-110
FAX. +49-9181-4509-310
infocomp@eu.sumida.com

Taipei
Tel.+886-2-8751-2737
FAX.+886-2-8751-2738
sales@tw.sumida.com

San Jose
Tel.+1-408-321-9660
FAX.+1-408-321-9308
sales@us.sumida.com

X-ON Electronics

Largest Supplier of Electrical and Electronic Components

Click to view similar products for [Fixed Inductors](#) category:

Click to view products by [Sumida](#) manufacturer:

Other Similar products are found below :

[CR32NP-100KC](#) [CR43NP-680KC](#) [CR54NP-820KC](#) [CR54NP-8R5MC](#) [CTX32CT-100](#) [70F224AI](#) [MGDQ4-00004-P](#) [MHL1ECTTP18NJ](#)
[MHL1JCTTD12NJ](#) [PE-51506NL](#) [PE-53601NL](#) [PE-53602NL](#) [PE-53630NL](#) [PE-53824SNLT](#) [PE-62892NL](#) [PE-92100NL](#) [PG0434.801NLT](#)
[PG0936.113NLT](#) [9310-16](#) [PM06-2N7](#) [PM06-39NJ](#) [A01TK](#) [1206CS-471XJ](#) [HC2-2R2TR](#) [HC2LP-R47-R](#) [HC3-2R2-R](#) [1206CS-151XG](#)
[RCH664NP-140L](#) [RCH664NP-4R7M](#) [RCH8011NP-221L](#) [RCP1317NP-332L](#) [RCP1317NP-391L](#) [RCR1010NP-470M](#) [RCR110DNP-331L](#)
[DH2280-4R7M](#) [DS1608C-106](#) [ASPI-4020HI-R10M-T](#) [B10TJ](#) [B82477P4333M](#) [B82498B3101J000](#) [B82498B3680J000](#) [ELJ-RE27NJF2](#)
[1812CS-153XJ](#) [1812CS-183XJ](#) [1812CS-223XJ](#) [1812LS-104XJ](#) [1812LS-105XJ](#) [1812LS-124XJ](#) [1812LS-154XJ](#) [1812LS-223XJ](#)