

# SMD Power Inductor CDRH8D58/LD



Halogen Free



## Description

- Ferrite drum core construction.
- Magnetically shielded.
- L × W × H: 8.3 × 8.3 × 6.0 mm Max.
- Product weight: 1.3g(Ref.)
- Moisture Sensitivity Level: 1
- RoHS compliance.
- Halogen Free available.

## Environmental Data

- Operating temperature range: -40°C~+105°C (including coil's self temperature rise)
- Storage temperature range: -40°C~+105°C
- Solder reflow temperature: 260 °C peak.

## Packaging

- Carrier tape and reel packaging
- 12.9" diameter reel
- 500pcs per reel

## Applications

- Ideally used in Notebook PC, Game machine, DVD, LCD TV, STB etc as DC-DC converter inductors.

## Dimension - [mm]

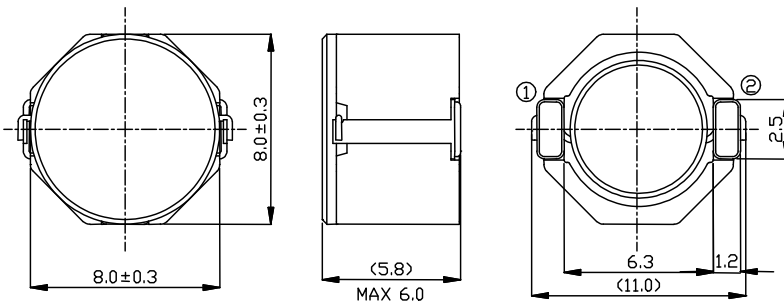

## Land pattern and Schematics - [mm]

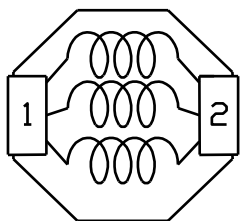
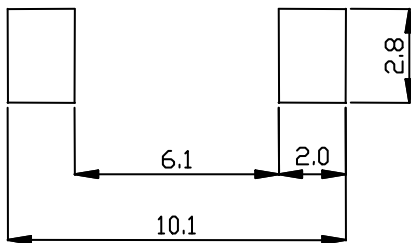

(2.8 μH ~ 10 μH)

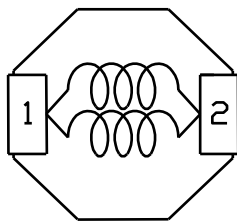

(15.0 μH ~ 47.0 μH)

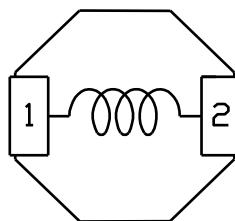

(68 μH ~ 100 μH)

# SMD Power Inductor

## CDRH8D58/LD



### Electrical Characteristics

Part Name	Stamp	Inductance ( $\mu$ H) [ within ] ※1	D.C.R. ( $m\Omega$ ) Max. (Typ.) (at 20°C)	Saturation Current (A) ※2		Temperature Rise Current (A) ※3
				at 20°C	at 100°C	
CDRH8D58/LDNP-2R8NC	2R8	2.8 $\pm$ 30%	15.0(12)	4.7	4.0	6.90
CDRH8D58/LDNP-3R9NC	3R9	3.9 $\pm$ 30%	16.3(13)	4.1	3.5	6.30
CDRH8D58/LDNP-5R0NC	5R0	5.0 $\pm$ 30%	17.5(14)	3.8	3.1	6.00
CDRH8D58/LDNP-6R2NC	6R2	6.2 $\pm$ 30%	20.0(16)	3.3	2.7	5.50
CDRH8D58/LDNP-100NC	100	10 $\pm$ 30%	25.6(20.5)	2.6	2.2	4.50
CDRH8D58/LDNP-150NC	150	15 $\pm$ 30%	36.3(29.0)	2.3	1.9	3.60
CDRH8D58/LDNP-220NC	220	22 $\pm$ 30%	45.3(36.2)	1.7	1.4	3.30
CDRH8D58/LDNP-330NC	330	33 $\pm$ 30%	65.3(52.2)	1.5	1.3	2.70
CDRH8D58/LDNP-470NC	470	47 $\pm$ 30%	90.5(72.4)	1.2	1.0	2.20
CDRH8D58/LDNP-680NC	680	68 $\pm$ 30%	130(104)	1.0	0.9	1.70
CDRH8D58/LDNP-101NC	101	100 $\pm$ 30%	175(140)	0.8	0.7	1.40

※1. Inductance measuring conditions at 100kHz.

※2. Saturation current: The DC current at which the inductance decreases to 65% of its nominal value.

※3. Temperature rise current: The DC current at which the temperature rise is  $\Delta t=40^{\circ}\text{C}$ . ( $T_a=20^{\circ}\text{C}$ )

# SMD Power Inductor CDRH8D58/LD



## Saturation Current & Temperature Rise Graph

— L (20°C) — L (100°C) —  $\Delta T$

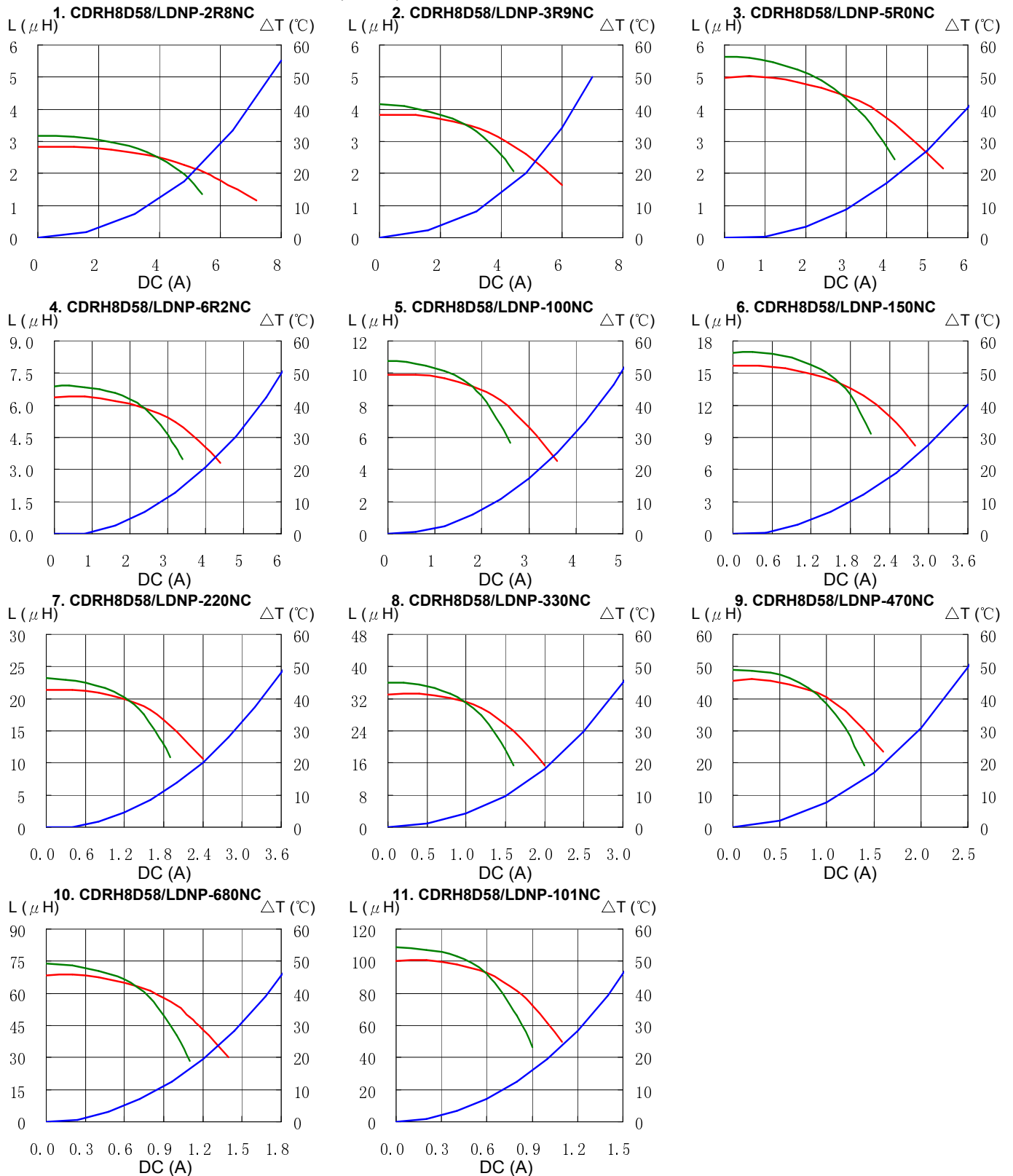

# SMD Power Inductor CDRH8D58/LD



## Solder Reflow Condition

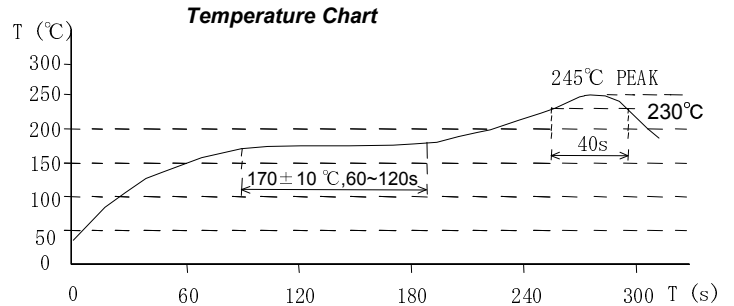
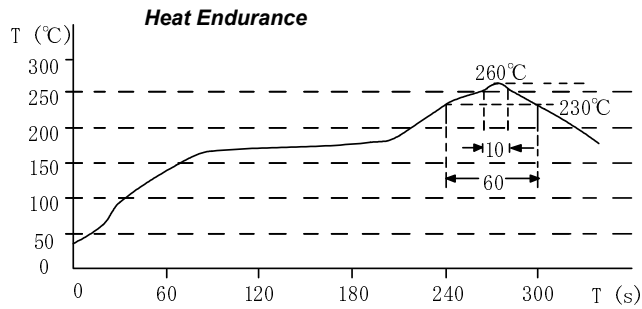

Please refer to the sales offices on our website - <http://www.sumida.com>

### Hong Kong

Tel.+852-2880-6781  
FAX.+852-2565-9600  
[sales@hk.sumida.com](mailto:sales@hk.sumida.com)

### Saitama(Japan)

Tel.+81-48-691-7300  
FAX.+81-48-691-7340  
[sales@jp.sumida.com](mailto:sales@jp.sumida.com)

### Chicago

Tel.+1-847-545-6700  
FAX. +1-847-545-6720  
[sales@us.sumida.com](mailto:sales@us.sumida.com)

### Shanghai

Tel.+86-21-5836-3299  
FAX.+86-21-5836-3266  
[shanghai.sales@cn.sumida.com](mailto:shanghai.sales@cn.sumida.com)

### Seoul

Tel.+82-2-6237-0777  
FAX.+82-2-6237-0778  
[sales@kr.sumida.com](mailto:sales@kr.sumida.com)

### Oberzell

Tel.+49-8591-937-0  
FAX. +49-8591-937-103  
[contact@eu.sumida.com](mailto:contact@eu.sumida.com)

### Shenzhen

Tel.+86-755-8291-0228  
FAX.+86-755-8291-0338  
[shenzhen.sales@cn.sumida.com](mailto:shenzhen.sales@cn.sumida.com)

### Singapore

Tel.+65-6296-3388  
FAX.+65-6841-4426  
[sales@sg.sumida.com](mailto:sales@sg.sumida.com)

### Neumarkt

Tel.+49-9181-4509-110  
FAX. +49-9181-4509-310  
[infocomp@eu.sumida.com](mailto:infocomp@eu.sumida.com)

### Taipei

Tel.+886-2-8751-2737  
FAX.+886-2-8751-2738  
[sales@tw.sumida.com](mailto:sales@tw.sumida.com)

### San Jose

Tel.+1-408-321-9660  
FAX.+1-408-321-9308  
[sales@us.sumida.com](mailto:sales@us.sumida.com)

## X-ON Electronics

Largest Supplier of Electrical and Electronic Components

*Click to view similar products for [Fixed Inductors](#) category:*

*Click to view products by [Sumida](#) manufacturer:*

Other Similar products are found below :

[MLZ1608M6R8WTD25](#) [MLZ1608N6R8LT000](#) [MLZ1608N3R3LTD25](#) [MLZ1608N3R3LT000](#) [MLZ1608N150LT000](#)

[MLZ1608M150WTD25](#) [MLZ1608M3R3WTD25](#) [MLZ1608M3R3WT000](#) [MLZ1608M150WT000](#) [MLZ1608A1R5WT000](#)

[MLZ1608N1R5LT000](#) [B82432C1333K000](#) [PCMB053T-1R0MS](#) [PCMB053T-1R5MS](#) [PCMB104T-1R5MS](#) [CR32NP-100KC](#) [CR32NP-](#)

[151KC](#) [CR32NP-180KC](#) [CR32NP-181KC](#) [CR32NP-1R5MC](#) [CR32NP-390KC](#) [CR32NP-3R9MC](#) [CR32NP-680KC](#) [CR32NP-820KC](#)

[CR32NP-8R2MC](#) [CR43NP-390KC](#) [CR43NP-560KC](#) [CR43NP-680KC](#) [CR54NP-181KC](#) [CR54NP-470LC](#) [CR54NP-820KC](#) [CR54NP-8R5MC](#)

[MGDQ4-00004-P](#) [MGDU1-00016-P](#) [MHL1ECTTP18NJ](#) [MHL1JCTTD12NJ](#) [PE-51506NL](#) [PE-53601NL](#) [PE-53630NL](#) [PE-53824SNLT](#) [PE-](#)

[62892NL](#) [PE-92100NL](#) [PG0434.801NLT](#) [PG0936.113NLT](#) [PM06-2N7](#) [PM06-39NJ](#) [HC2LP-R47-R](#) [HC2-R47-R](#) [HC3-2R2-R](#) [HC8-1R2-R](#)