

SMD Power Inductor CDRR105



Halogen Free



Description

- Ferrite drum core construction.
- Magnetically shielded.
- L × W × H: 10.4 × 10.4 × 4.8 mm Max.
- Product weight: 1.3 g(Ref.)
- Moisture Sensitivity Level: 1
- RoHS compliance.
- Halogen Free available.

Environmental Data

- Operating temperature range: -40°C~+125°C (including coil's self temperature rise)
- Storage temperature range: -40°C~+125°C
- Solder reflow temperature: 260 °C peak.

Packaging

- Carrier tape and reel packaging
- 13.0" diameter reel
- 500pcs per reel

Applications

- For consumer electronics :HDD, personal computer, LCD display, etc.
- For automotive: ABS, SRS airbag, HID/LED, car audio, car navigation, LCD display, etc.

Dimension - [mm]

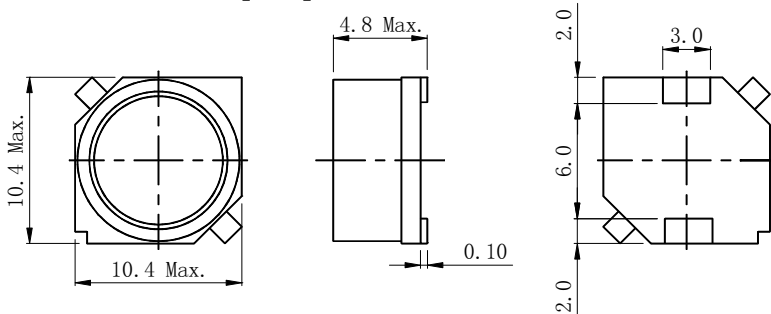

Land pattern and Schematics - [mm]

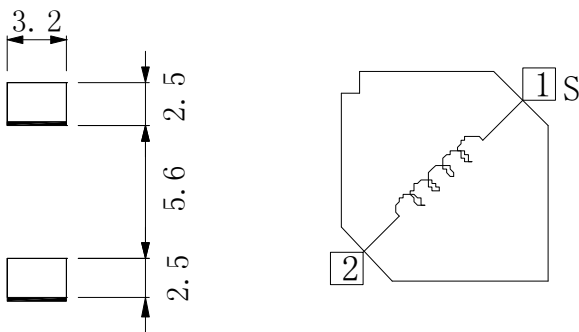

SMD Power Inductor CDRR105

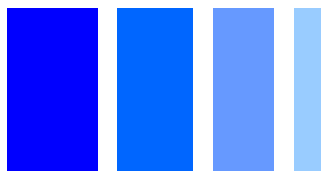

Electrical Characteristics

Part No.	Stamp	Inductance (μ H) [Within] ※1	D.C.R.(Ω) Max. (Typ.) (at 20°C)	DC Saturation Current (A) ※2		Temperature Rise Current (A) ※3
				(at 20°C)	(at 125°C)	
CDRR105NP-3R3NC	3R3	3.3 \pm 30%	21.0m(16.8m)	4.80(6.00)	3.76(4.70)	4.90(5.60)
CDRR105NP-5R6MC	5R6	5.6 \pm 20%	29.6m(23.7m)	3.52(4.40)	2.88(3.60)	3.90(4.50)
CDRR105NP-100MC	100	10 \pm 20%	47.5m(38.0m)	2.48(3.10)	1.92(2.40)	3.00(3.42)
CDRR105NP-150MC	150	15 \pm 20%	63.8m(51.0m)	2.00(2.50)	1.56(1.95)	2.71(3.08)
CDRR105NP-220MC	220	22 \pm 20%	77.5m(62.0m)	1.66(2.08)	1.30(1.62)	2.35(2.70)
CDRR105NP-330MC	330	33 \pm 20%	0.105(84.0m)	1.32(1.65)	1.00(1.25)	1.93(2.20)
CDRR105NP-470MC	470	47 \pm 20%	0.138(0.110)	1.12(1.40)	0.87(1.09)	1.70(1.92)
CDRR105NP-680MC	680	68 \pm 20%	0.195(0.156)	0.98(1.22)	0.70(0.87)	1.38(1.58)
CDRR105NP-101MC	101	100 \pm 20%	0.278(0.222)	0.80(1.00)	0.63(0.79)	1.16(1.33)
CDRR105NP-151MC	151	150 \pm 20%	0.425(0.340)	0.67(0.84)	0.52(0.65)	0.93(1.05)
CDRR105NP-221MC	221	220 \pm 20%	0.573(0.458)	0.51(0.64)	0.40(0.50)	0.76(0.87)
CDRR105NP-331MC	331	330 \pm 20%	0.848(0.678)	0.44(0.54)	0.34(0.42)	0.61(0.71)
CDRR105NP-471MC	471	470 \pm 20%	1.20(1.01)	0.38(0.48)	0.30(0.37)	0.54(0.62)
CDRR105NP-681MC	681	680 \pm 20%	1.82(1.52)	0.32(0.39)	0.24(0.30)	0.42(0.48)
CDRR105NP-102MC	102	1000 \pm 20%	2.71(2.26)	0.26(0.32)	0.20(0.24)	0.32(0.37)
CDRR105NP-152MC	152	1500 \pm 20%	4.00(3.33)	0.21(0.26)	0.16(0.20)	0.27(0.32)

※1. Measuring condition: at 1kHz.

※2. Saturation current: The value of D.C. current when the inductance decreases to 90% of it's nominal value.

※3. Temperature rise current: The value of D.C. current when the temperature rise is $\Delta t=40^{\circ}\text{C}$ ($T_a=20^{\circ}\text{C}$).

SMD Power Inductor CDRR105



Saturation Current & Temperature Rise Graph

— L (20°C) — L (125°C) — ΔT

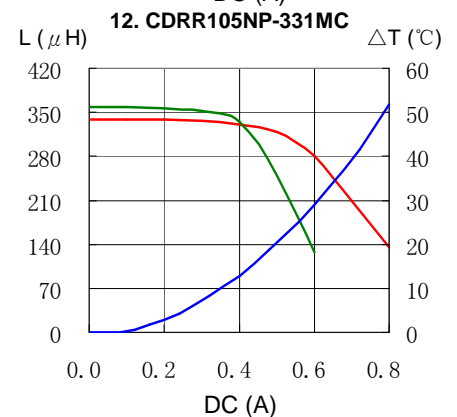
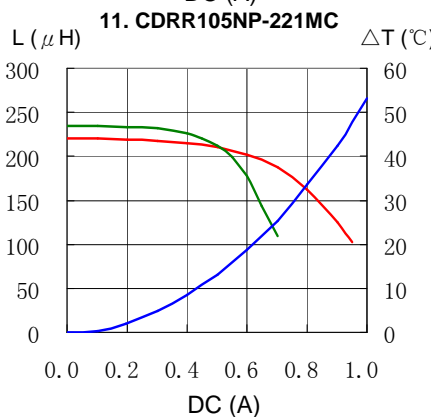
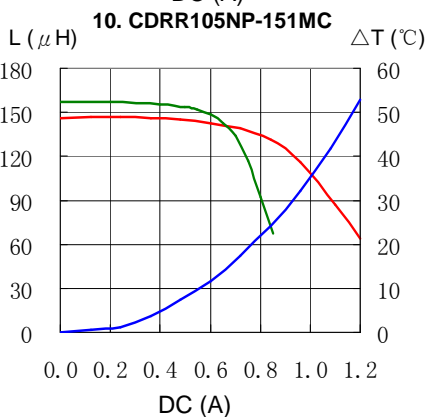
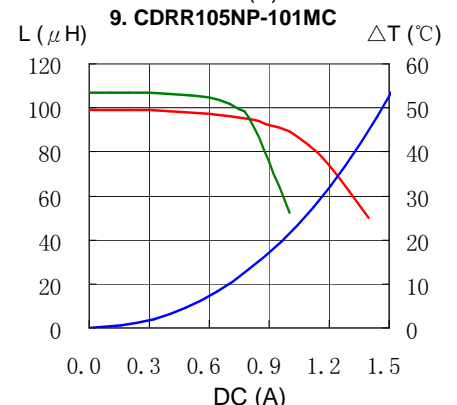
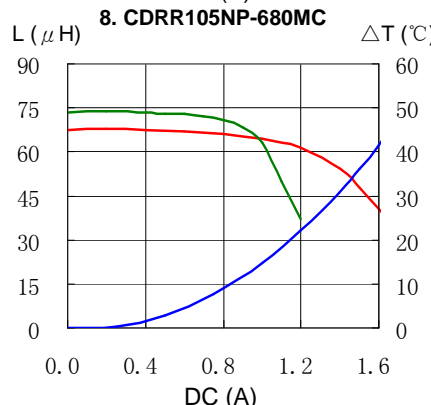
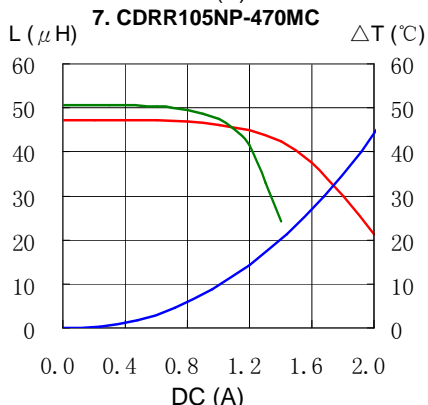
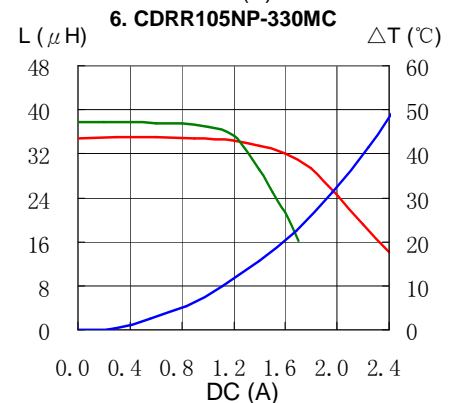
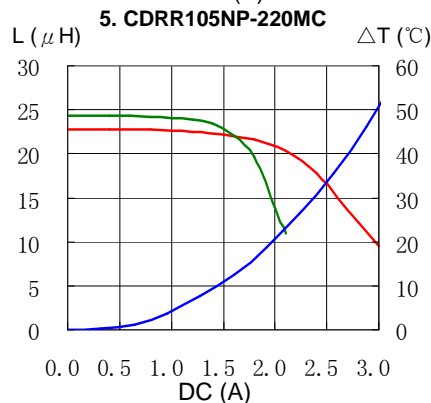
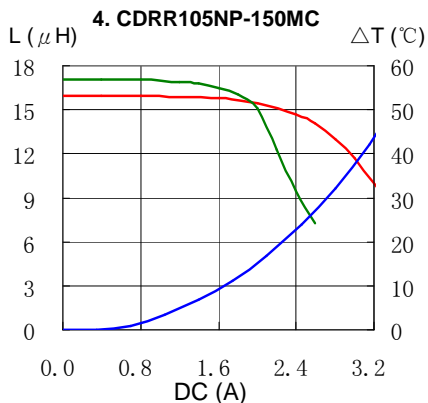
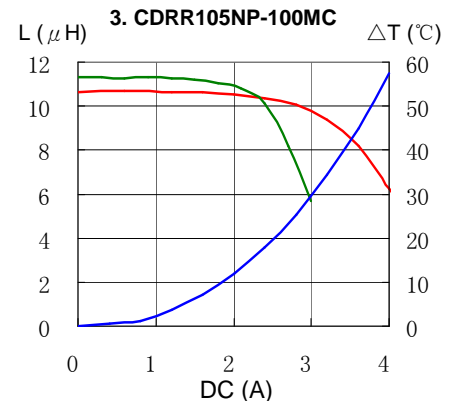
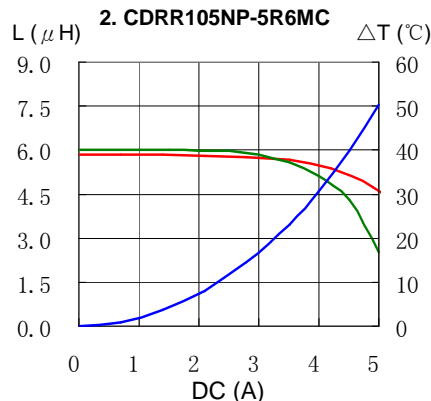
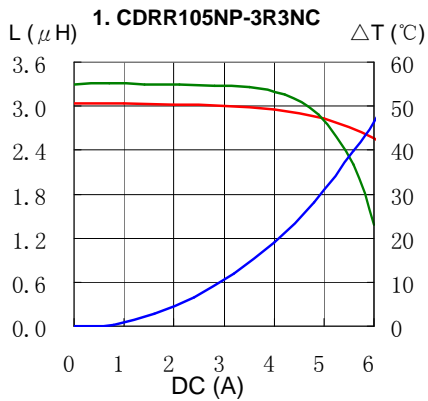

SMD Power Inductor CDRR105



Saturation Current & Temperature Rise Graph

— L (20°C) — L (125°C) — ΔT

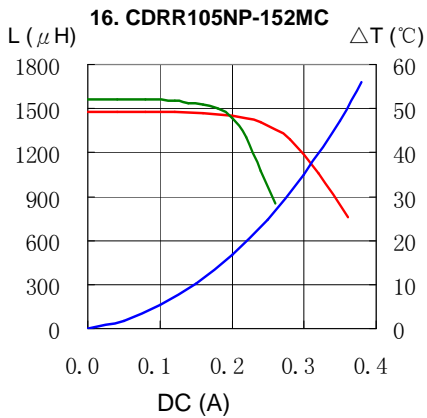
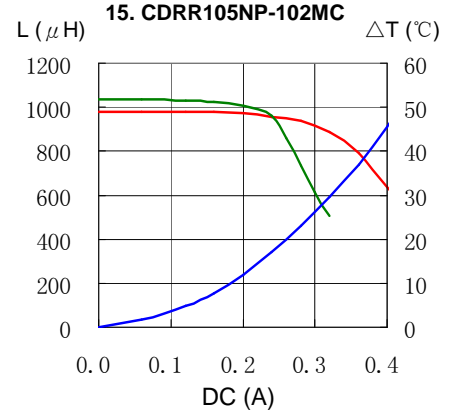
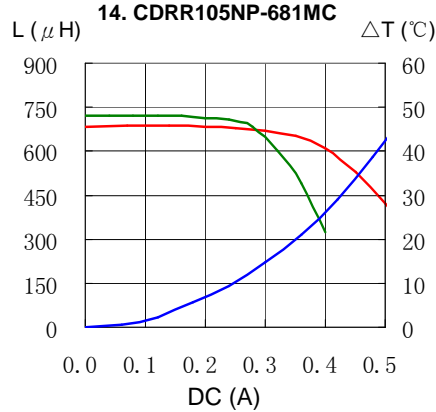
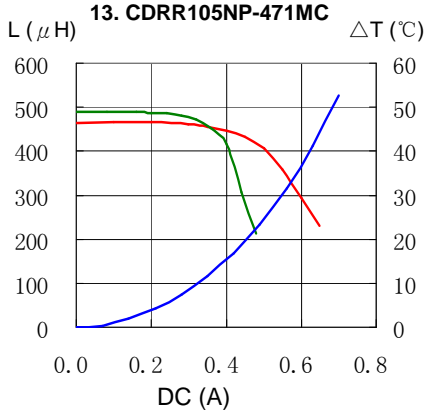

Solder Reflow Condition

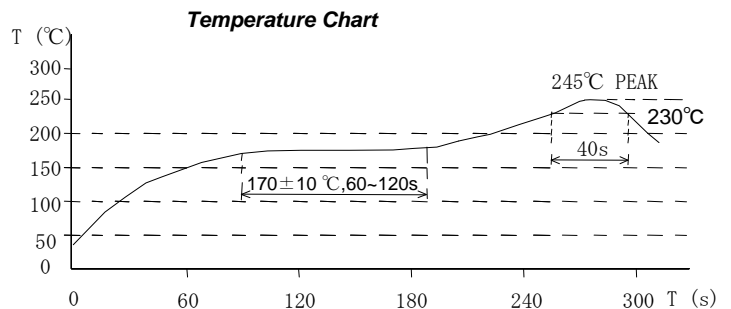
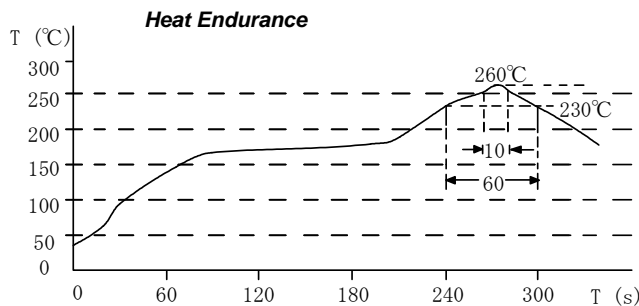

Please refer to the sales offices on our website - <http://www.sumida.com>

Hong Kong
Tel.+852-2880-6781
FAX.+852-2565-9600
sales@hk.sumida.com

Saitama(Japan)
Tel.+81-48-691-7300
FAX.+81-48-691-7340
sales@jp.sumida.com

Chicago
Tel.+1-847-545-6700
FAX. +1-847-545-6720
sales@us.sumida.com

Shanghai
Tel.+86-21-5836-3299
FAX.+86-21-5836-3266
shanghai.sales@cn.sumida.com

Seoul
Tel.+82-2-6237-0777
FAX.+82-2-6237-0778
sales@kr.sumida.com

Oberzell
Tel.+49-8591-937-0
FAX. +49-8591-937-103
contact@eu.sumida.com

Shenzhen
Tel.+86-755-8291-0228
FAX.+86-755-8291-0338
shenzhen.sales@cn.sumida.com

Singapore
Tel.+65-6296-3388
FAX.+65-6841-4426
sales@sg.sumida.com

Neumarkt
Tel.+49-9181-4509-110
FAX. +49-9181-4509-310
infocomp@eu.sumida.com

Taipei
Tel.+886-2-8751-2737
FAX.+886-2-8751-2738
sales@tw.sumida.com

San Jose
Tel.+1-408-321-9660
FAX.+1-408-321-9308
sales@us.sumida.com

X-ON Electronics

Largest Supplier of Electrical and Electronic Components

Click to view similar products for [Power Inductors - SMD category](#):

Click to view products by [Sumida manufacturer](#):

Other Similar products are found below :

[SPD62R-472M](#) [LLQPB201214T1R0M](#) [LLXND3030QKT470MNG](#) [LLQPB160807T4R7M](#) [LLAPB2016KKTR33M](#)
[LBXND4040TKL330MDG](#) [LLXNE3030KKT4R7MN](#) [LSQEA201212T100M](#) [IHLP5050CEER4R7M06](#) [LVS505020-1R0T-N](#) [LVS505040-1R2T-N](#) [LVS606020-1R5M-N](#) [LVS606028-6R8M-N](#) [LVS606045-102M-N](#) [LVS606045-150M-N](#) [LVS606045-1R8M-N](#) [LVS606045-6R8M-N](#) [LVS808040-2R0M-N](#) [LVS808040-330M-N](#) [LVS808040-4R7M-N](#) [MHCI06030-R56M-R8](#) [SCD0403T-470M-N](#) [SCD0403T-6R8K-N](#) [SCD0504T-101M-N](#) [SCD0504T-120M-N](#) [SCD0504T-221M-N](#) [SCD0504T-470M-N](#) [SCD0504T-471M-N](#) [SCD0705T-180M-N](#) [SCD0705T-221M-N](#) [SCD0705T-470M-N](#) [SCD1005T-101M-N](#) [SCD1005T-221M-N](#) [SCD1005T-470M-N](#) [SSL1306T-101M-N](#) [LQB15NNR27K10D](#) [201610CDMCDDS-R47MC](#) [201610CDMCDDS-1R0MC](#) [201610CDMCDDS-R68MC](#) [LSQPB201210T220M](#) [LBCNF2012KKTR24MA](#) [LSQEA201212T220K](#) [LSENC2016KKT1R0M](#) [LSQNB160808T470M](#) [LSBHB1608KKT2R2MG](#) [LSQPB160807T2R2M](#) [LSQEA201212T101K](#) [LCXND4040MKL4R7MDG](#) [DEM8045Z-5R6N=P3](#) [LCXNH8080YKL101MJG](#)