

SMD Power Inductor CDRR126



Halogen Free



Description

- Ferrite drum core construction.
- Magnetically shielded.
- L × W × H: 12.8 × 12.8 × 6.8 mm Max.
- Product weight: 2.9 g(Ref.)
- Moisture Sensitivity Level: 1
- RoHS compliance.
- Halogen Free available.

Environmental Data

- Operating temperature range: -40°C~+125°C (including coil's self temperature rise)
- Storage temperature range: -40°C~+125°C
- Solder reflow temperature: 260 °C peak.

Packaging

- Carrier tape and reel packaging.
- 13.0" diameter reel
- 500pcs per reel

Applications

- For consumer electronics :DVD player, person computer, LCD display, etc.
- For automotive: ABS, SRS airbag, HID/LED, car audio, car navigation, LCD display, etc.

Dimension - [mm]

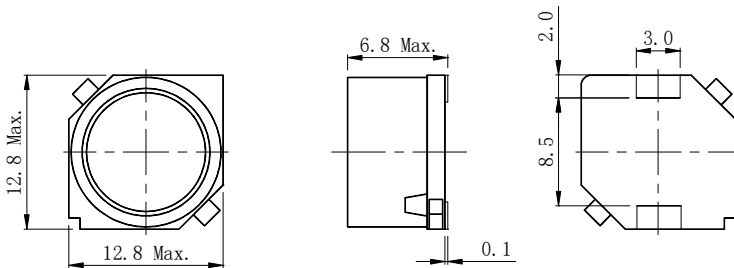

Land pattern and Schematics - [mm]

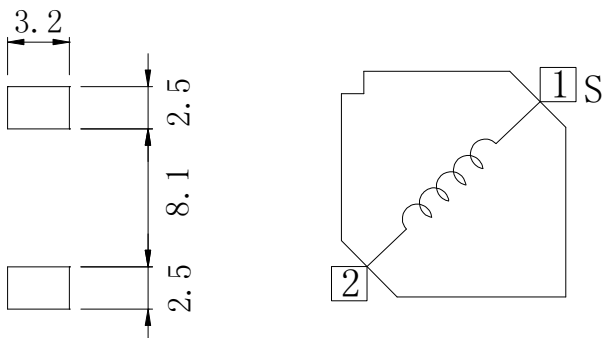

SMD Power Inductor CDRR126



Electrical Characteristics

Part No.	Stamp	Inductance [Within] ※1	D.C.R. (Ω) [Max.] (Typ.) (at 20°C)	Saturation current (A) ※2		Temperature rise current (A) ※3
				(at 25°C)	(at 125°C)	
CDRR126NP-7R0NC	7R0	7.0 μH ± 30%	28m(22m)	5.00(6.25)	3.84(4.80)	4.62(5.30)
CDRR126NP-100MC	100	10 μH ± 20%	33m(26m)	4.30(5.38)	3.32(4.15)	4.18(4.70)
CDRR126NP-150MC	150	15 μH ± 20%	38m(30m)	3.68(4.60)	2.87(3.59)	3.73(4.25)
CDRR126NP-220MC	220	22 μH ± 20%	45m(36m)	3.08(3.85)	2.26(2.82)	3.30(3.80)
CDRR126NP-330MC	330	33 μH ± 20%	66m(53m)	2.28(2.85)	1.76(2.20)	2.65(3.20)
CDRR126NP-470MC	470	47 μH ± 20%	80m(64m)	2.08(2.60)	1.56(1.95)	2.52(2.86)
CDRR126NP-680MC	680	68 μH ± 20%	0.118(95m)	1.68(2.10)	1.28(1.60)	2.00(2.30)
CDRR126NP-101MC	101	100 μH ± 20%	0.166(0.133)	1.36(1.70)	1.03(1.29)	1.60(1.83)
CDRR126NP-151MC	151	150 μH ± 20%	0.234(0.187)	1.10(1.37)	0.83(1.04)	1.33(1.53)
CDRR126NP-221MC	221	220 μH ± 20%	0.371(0.297)	0.90(1.12)	0.71(0.89)	1.09(1.22)
CDRR126NP-331MC	331	330 μH ± 20%	0.538(0.430)	0.77(0.96)	0.61(0.76)	0.88(1.00)

※1. Measuring condition: at 1kHz.

※2. Saturation current: The value of D.C. current when the inductance decreases to 90% of its nominal value.

※3. Temperature rise current: The value of D.C. current when the temperature rise is $\Delta t = 40^\circ\text{C}$ ($T_a = 20^\circ\text{C}$).

SMD Power Inductor CDRR126



Saturation Current & Temperature Rise Graph

— L (25°C) — L (125°C) — ΔT

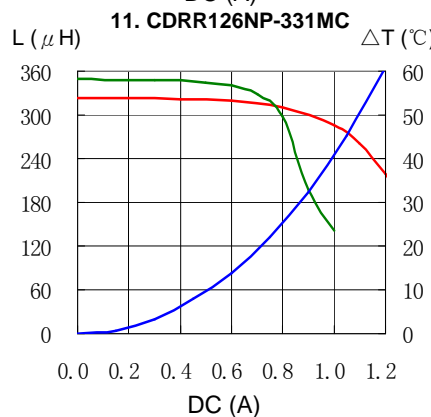
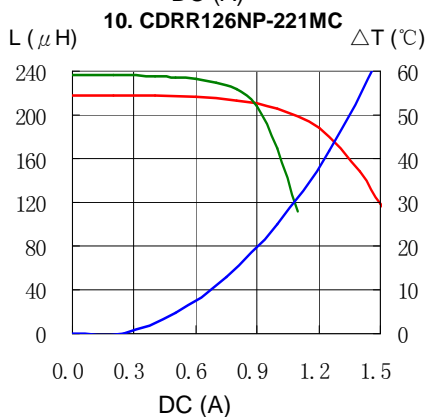
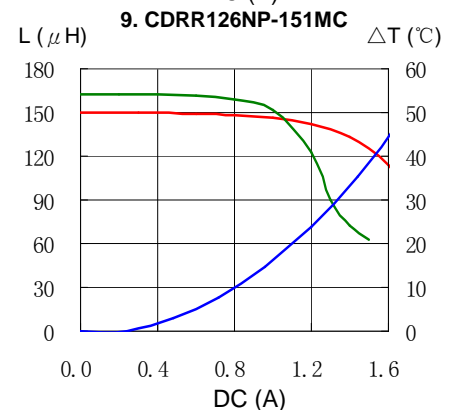
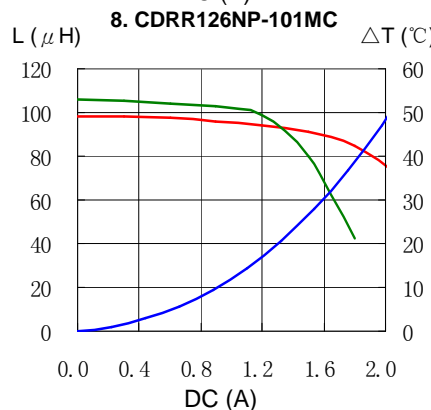
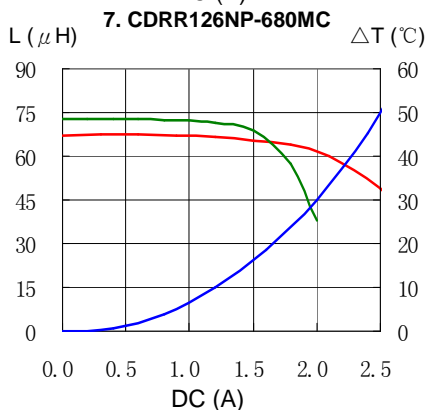
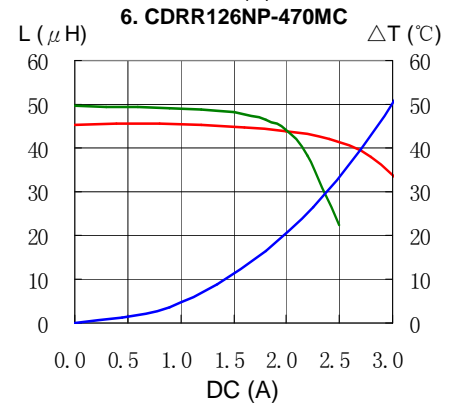
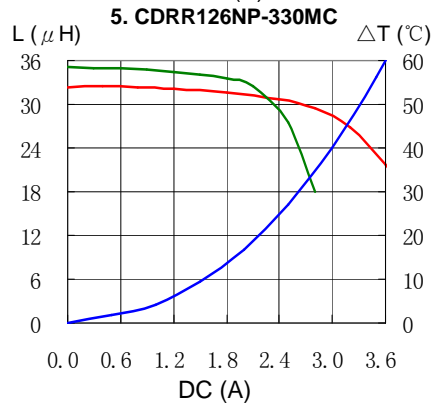
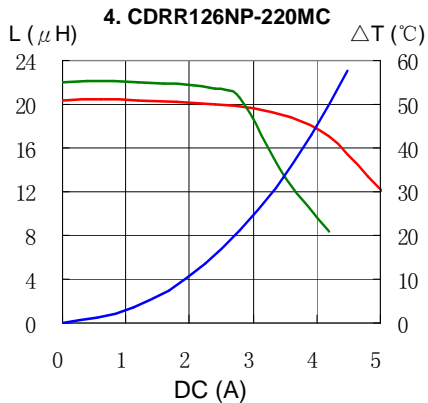
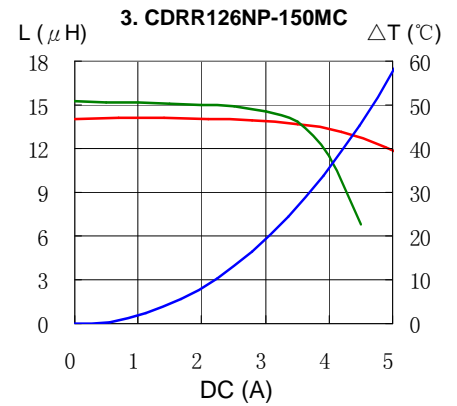
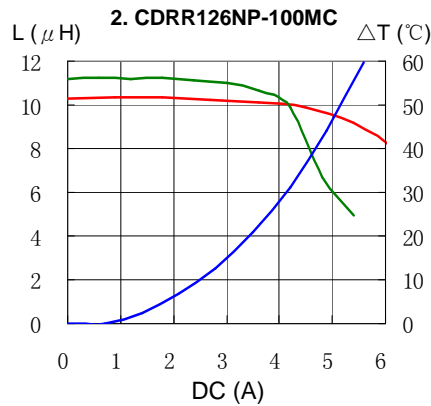
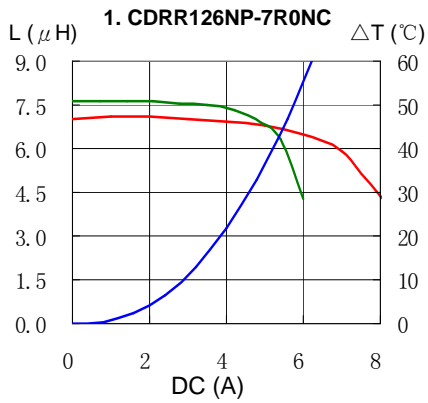

SMD Power Inductor CDRR126



Solder Reflow Condition

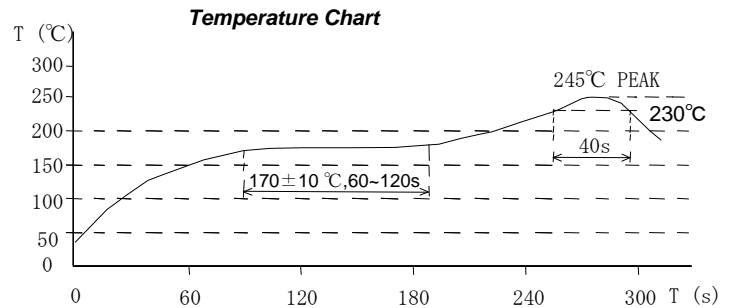
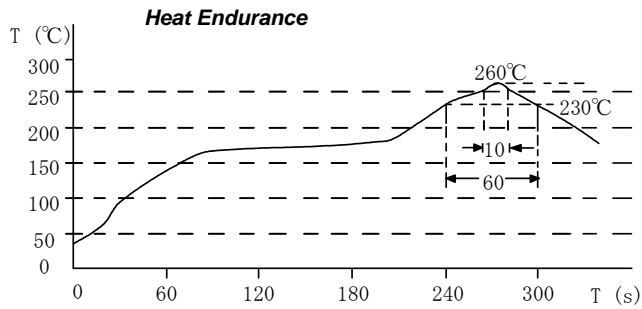

Please refer to the sales offices on our website - <http://www.sumida.com>

Hong Kong

Tel.+852-2880-6781
FAX.+852-2565-9600
sales@hk.sumida.com

Saitama(Japan)

Tel.+81-48-691-7300
FAX.+81-48-691-7340
sales@jp.sumida.com

Chicago

Tel.+1-847-545-6700
FAX. +1-847-545-6720
sales@us.sumida.com

Shanghai

Tel.+86-21-5836-3299
FAX.+86-21-5836-3266
shanghai.sales@cn.sumida.com

Seoul

Tel.+82-2-6237-0777
FAX.+82-2-6237-0778
sales@kr.sumida.com

Oberzell

Tel.+49-8591-937-0
FAX. +49-8591-937-103
contact@eu.sumida.com

Shenzhen

Tel.+86-755-8291-0228
FAX.+86-755-8291-0338
shenzhen.sales@cn.sumida.com

Singapore

Tel.+65-6296-3388
FAX.+65-6841-4426
sales@sg.sumida.com

Neumarkt

Tel.+49-9181-4509-110
FAX. +49-9181-4509-310
infocomp@eu.sumida.com

Taipei

Tel.+886-2-8751-2737
FAX.+886-2-8751-2738
sales@tw.sumida.com

San Jose

Tel.+1-408-321-9660
FAX.+1-408-321-9308
sales@us.sumida.com

X-ON Electronics

Largest Supplier of Electrical and Electronic Components

Click to view similar products for [Power Inductors - SMD category](#):

Click to view products by [Sumida manufacturer](#):

Other Similar products are found below :

[SPD62R-472M](#) [LLQPB201214T1R0M](#) [LLXND3030QKT470MNG](#) [LLQPB160807T4R7M](#) [LLAPB2016KKTR33M](#)
[LBXND4040TKL330MDG](#) [LLXNE3030KKT4R7MN](#) [LSQEA201212T100M](#) [IHLP5050CEER4R7M06](#) [LVS505020-1R0T-N](#) [LVS505040-1R2T-N](#) [LVS606020-1R5M-N](#) [LVS606028-6R8M-N](#) [LVS606045-102M-N](#) [LVS606045-150M-N](#) [LVS606045-1R8M-N](#) [LVS606045-6R8M-N](#) [LVS808040-2R0M-N](#) [LVS808040-330M-N](#) [LVS808040-4R7M-N](#) [MHCI06030-R56M-R8](#) [SCD0403T-470M-N](#) [SCD0403T-6R8K-N](#) [SCD0504T-101M-N](#) [SCD0504T-120M-N](#) [SCD0504T-221M-N](#) [SCD0504T-470M-N](#) [SCD0504T-471M-N](#) [SCD0705T-180M-N](#) [SCD0705T-221M-N](#) [SCD0705T-470M-N](#) [SCD1005T-101M-N](#) [SCD1005T-221M-N](#) [SCD1005T-470M-N](#) [SSL1306T-101M-N](#) [LQB15NNR27K10D](#) [201610CDMCDDS-R47MC](#) [201610CDMCDDS-1R0MC](#) [201610CDMCDDS-R68MC](#) [LSQPB201210T220M](#) [LBCNF2012KKTR24MA](#) [LSQEA201212T220K](#) [LSENC2016KKT1R0M](#) [LSBHB1608KKT2R2MG](#) [LSQPB160807T2R2M](#) [LSQEA201212T101K](#) [LCXND4040MKL4R7MDG](#) [DEM8045Z-5R6N=P3](#) [LCXNH8080YKL101MJG](#) [LSCNA2012KKT1R0MA](#)