

# SMD Power Inductor

## CDRR7D45/T125



### Description

- Ferrite drum core construction
- Magnetically shielded
- LxWxH: 7.2x7.2x4.8 mm Max.
- Product weight:0.6 g(Ref.)
- Moisture Sensitivity Level: 1
- RoHS compliance



### Environmental Data

- Operating Temperature: -40°C to +125°C (including self-heating)
- Storage temperature range: -40°C~+125°C

### Packaging

- Carrier tape and reel packaging

### Applications

- High temp and high reliability automotive applications

### Dimension - [mm]

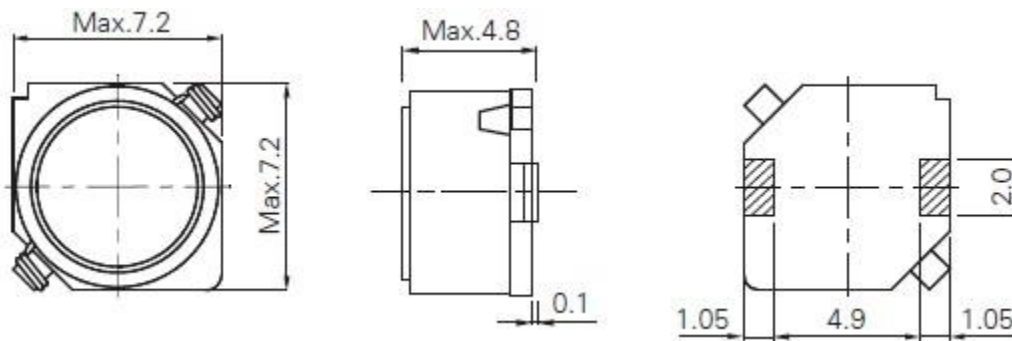

### Recommended Land pattern - [mm]

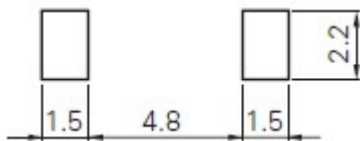

### Wire Connection

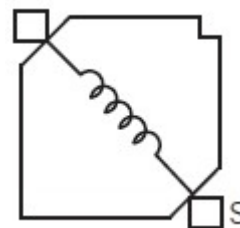

# SMD Power Inductor

## CDRR7D45/T125



### Electrical Characteristics

Part Number	Inductance [Within] ( $\mu$ H) ※1	D.C.R. at 20°C Max.(Typ.) (m $\Omega$ )	Saturation Current (A) Max.(Typ.) ※2	Temperature Rise Current (A) Max.(Typ.) ※3
CDRR7D45T125NP-3R3MC	3.30 $\pm$ 20%	33.60 (28.00)	3.50 (4.40)	3.20 (3.65)
CDRR7D45T125NP-4R7MC	4.70 $\pm$ 20%	37.20 (31.00)	2.80 (3.58)	2.90 (3.34)
CDRR7D45T125NP-6R8MC	6.80 $\pm$ 20%	46.80 (39.00)	2.40 (3.02)	2.45 (2.81)
CDRR7D45T125NP-100MC	10.00 $\pm$ 20%	56.40 (47.00)	1.96 (2.47)	2.25 (2.60)
CDRR7D45T125NP-150MC	15.00 $\pm$ 20%	81.60 (68.00)	1.64 (2.08)	1.85 (2.10)
CDRR7D45T125NP-220MC	22.00 $\pm$ 20%	98.40 (82.00)	1.36 (1.70)	1.60 (1.82)
CDRR7D45T125NP-330MC	33.00 $\pm$ 20%	144 (120)	1.21 (1.45)	1.30 (1.50)
CDRR7D45T125NP-470MC	47.00 $\pm$ 20%	216 (180)	0.94 (1.17)	1.10 (1.27)
CDRR7D45T125NP-680MC	68.00 $\pm$ 20%	324 (270)	0.78 (0.95)	0.90 (1.04)
CDRR7D45T125NP-101MC	100 $\pm$ 20%	468 (390)	0.62 (0.76)	0.73 (0.85)
CDRR7D45T125NP-151MC	150 $\pm$ 20%	660 (550)	0.52 (0.65)	0.65 (0.74)
CDRR7D45T125NP-221MC	220 $\pm$ 20%	996 (830)	0.44 (0.56)	0.54 (0.60)
CDRR7D45T125NP-331MC	330 $\pm$ 20%	1380 (1150)	0.35 (0.46)	0.44 (0.50)
CDRR7D45T125NP-471MC	470 $\pm$ 20%	2160 (1800)	0.31 (0.38)	0.36 (0.41)

※1. Inductance measuring condition: at 100 kHz.

※2. Saturation current: The value of D.C. current when the inductance decreases to 90% of its nominal value.

※3. Temperature rise current: The value of D.C. current when the temperature rise is  $\Delta t=40^{\circ}\text{C}$ ( $T_a=20^{\circ}\text{C}$ ).

### Solder Reflow Condition

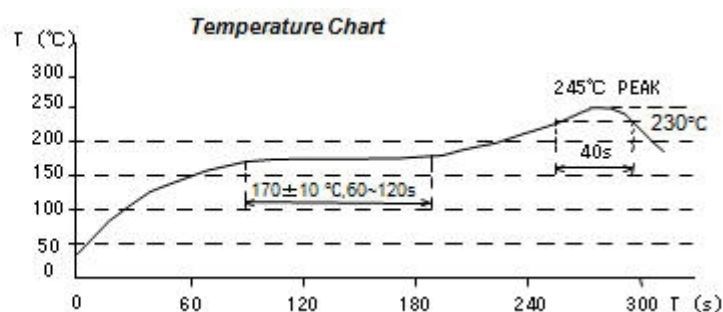
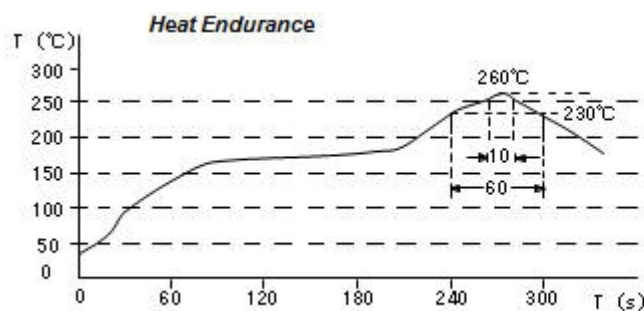

# SMD Power Inductor

## CDRR7D45/T125



### Saturation Current & Temperature Rise Graph

— L (20°C)    —  $\Delta T$

1. CDRR7D45T125NP-3R3MC

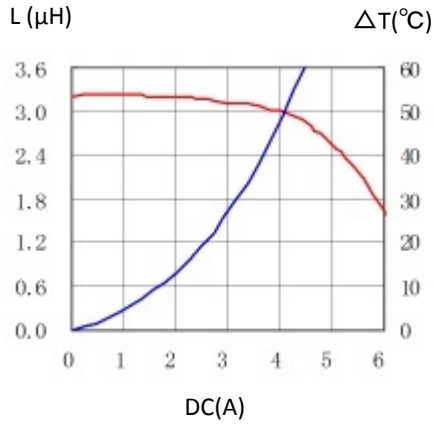

2. CDRR7D45T125NP-4R7MC

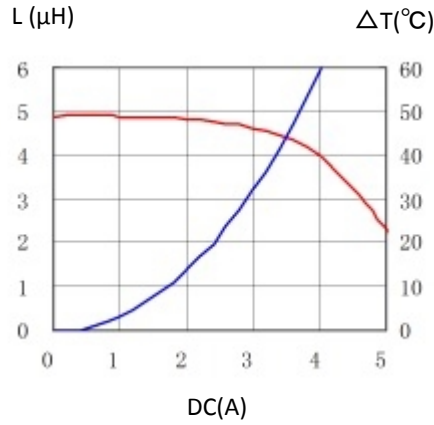

3. CDRR7D45T125NP-6R8MC

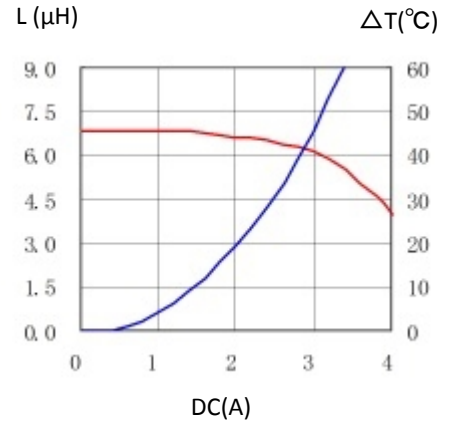

4. CDRR7D45T125NP-100MC

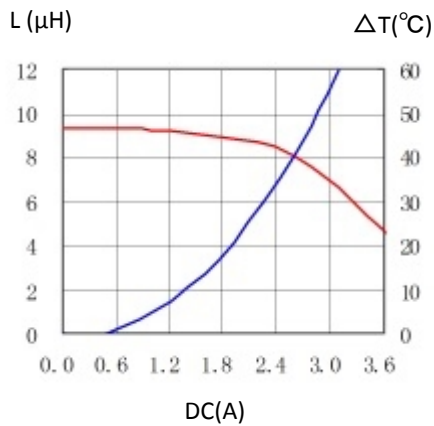

5. CDRR7D45T125NP-150MC

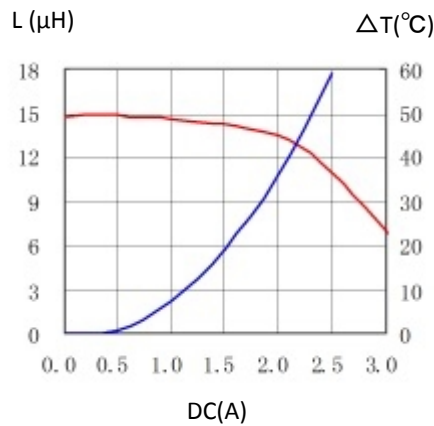

6. CDRR7D45T125NP-220MC

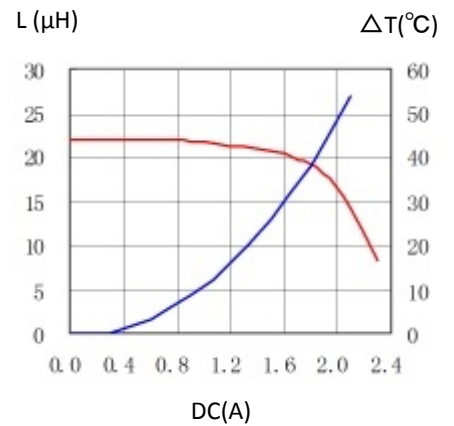

7. CDRR7D45T125NP-330MC

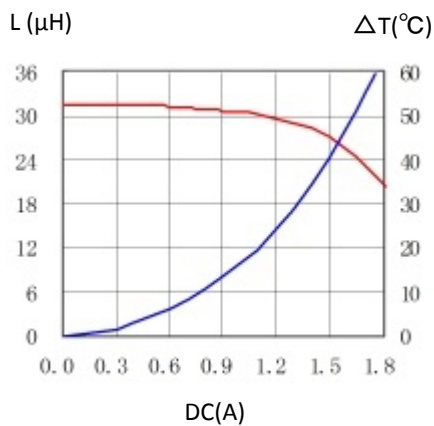

8. CDRR7D45T125NP-470MC

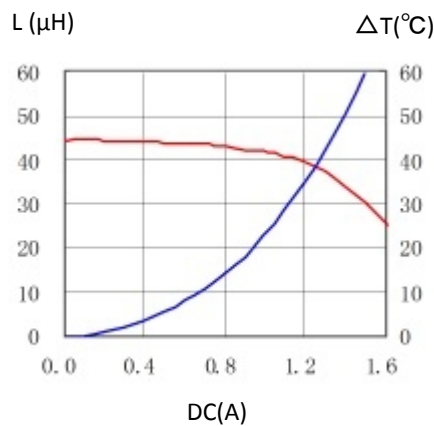

9. CDRR7D45T125NP-680MC

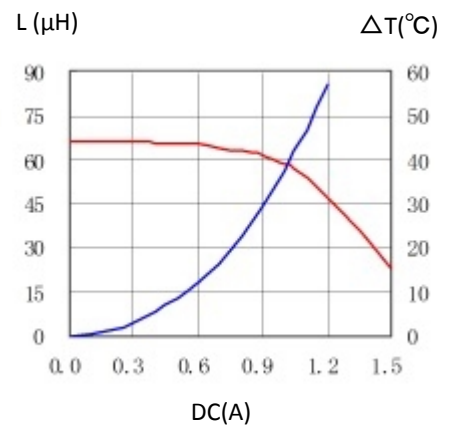

# SMD Power Inductor

## CDRR7D45/T125



10. CDRR7D45T125NP-101MC

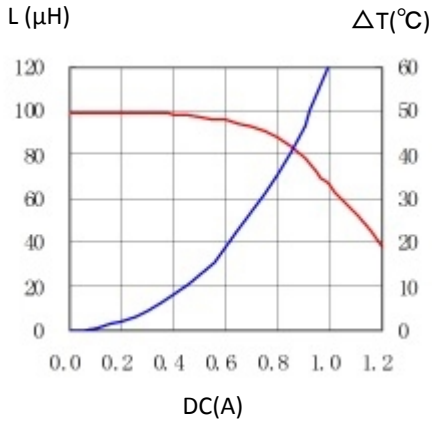

11. CDRR7D45T125NP-151MC

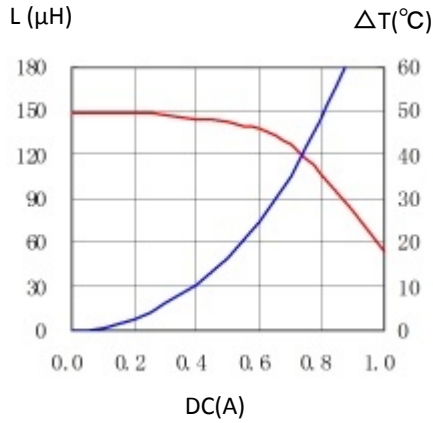

12. CDRR7D45T125NP-221MC

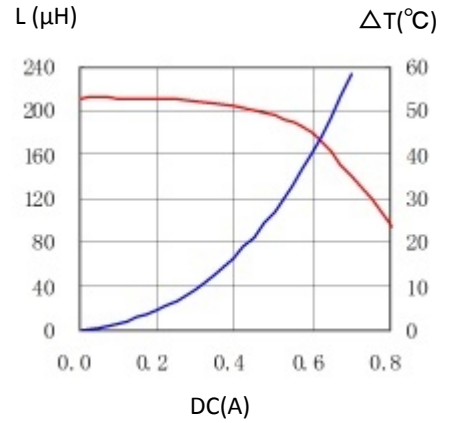

13. CDRR7D45T125NP-331MC

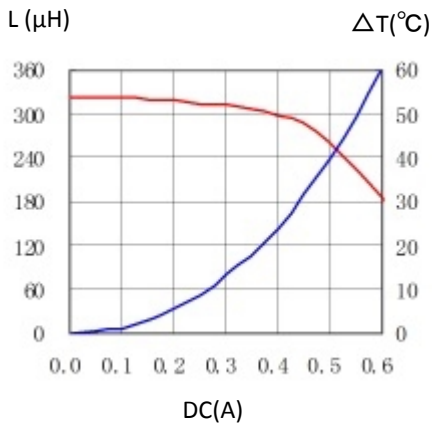

14. CDRR7D45T125NP-471MC

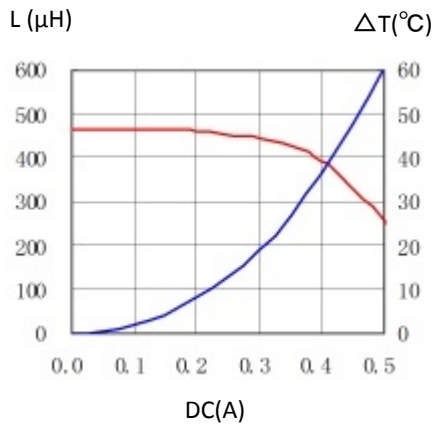

For sales office information, please [click here](#) to visit our website.

## X-ON Electronics

Largest Supplier of Electrical and Electronic Components

*Click to view similar products for [Power Inductors - SMD category](#):*

*Click to view products by [Sumida manufacturer](#):*

Other Similar products are found below :

[SPD62R-472M](#) [LLQPB201214T1R0M](#) [LLXND3030QKT470MNG](#) [LLQPB160807T4R7M](#) [LLAPB2016KKTR33M](#)  
[LBXND4040TKL330MDG](#) [LLXNE3030KKT4R7MN](#) [LSQEA201212T100M](#) [IHLP5050CEER4R7M06](#) [LVS505020-1R0T-N](#) [LVS505040-1R2T-N](#) [LVS606020-1R5M-N](#) [LVS606028-6R8M-N](#) [LVS606045-102M-N](#) [LVS606045-150M-N](#) [LVS606045-1R8M-N](#) [LVS606045-6R8M-N](#) [LVS808040-2R0M-N](#) [LVS808040-330M-N](#) [LVS808040-4R7M-N](#) [MHCI06030-R56M-R8](#) [SCD0403T-470M-N](#) [SCD0403T-6R8K-N](#) [SCD0504T-101M-N](#) [SCD0504T-120M-N](#) [SCD0504T-221M-N](#) [SCD0504T-470M-N](#) [SCD0504T-471M-N](#) [SCD0705T-180M-N](#) [SCD0705T-221M-N](#) [SCD0705T-470M-N](#) [SCD1005T-101M-N](#) [SCD1005T-221M-N](#) [SCD1005T-470M-N](#) [SSL1306T-101M-N](#) [LQB15NNR27K10D](#) [201610CDMCDDS-R47MC](#) [201610CDMCDDS-1R0MC](#) [201610CDMCDDS-R68MC](#) [LSQPB201210T220M](#) [LBCNF2012KKTR24MA](#) [LSQEA201212T220K](#) [LSENC2016KKT1R0M](#) [LSBHB1608KKT2R2MG](#) [LSQPB160807T2R2M](#) [LSQEA201212T101K](#) [LCXND4040MKL4R7MDG](#) [DEM8045Z-5R6N=P3](#) [LCXNH8080YKL101MJG](#) [LSCNA2012KKT1R0MA](#)