

SMD Power Inductor

CY1770AT125/DS



特点

- Metal alloy
- Magnetically shielded
- L×W×H:18×17.3×7.0mm Max.
- Absolute maximum voltage (across inductor): 50V
- Product weight:0.75g (Ref.)
- Moisture Sensitivity Level: 1
- AEC-Q200 qualified

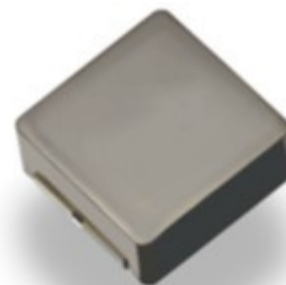

环境规格

- Operating temperature range: -40°C~+125°C (including coil's self temperature rise)

包装

- Carrier tape and reel packaging
- 150pcs per reel

用途

- Suitable for DC/DC converter on ECU and LED head light, the other high reliability environment for automotive application.

外形尺寸 - [mm]

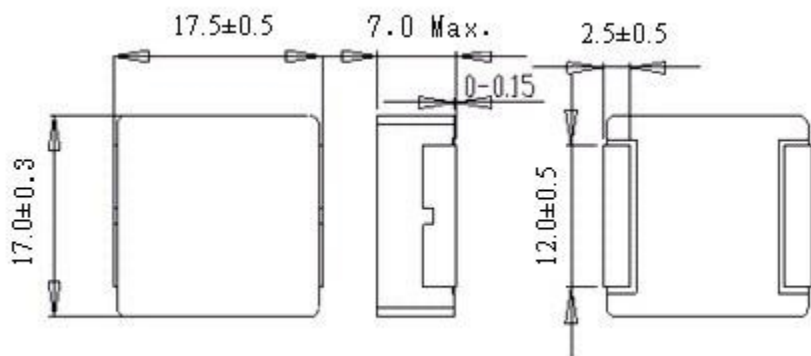

推荐焊盘尺寸 - [mm]

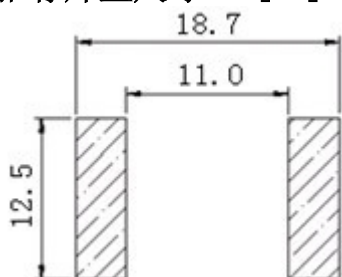

接线图 (底面)

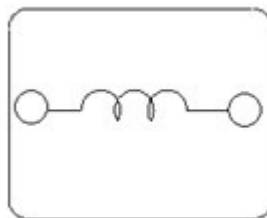

SMD Power Inductor

CY1770AT125/DS



电气特性规格

品名	电感值 [within] (μ H) ※1	直流电阻 (20°C) Max. (Typ.) (m Ω)	饱和电流 (A) Max. (Typ.) ※2	温度上升电流 (A) Max. (Typ.) ※3
CY1770AT125DS-1R0MC	1.00 \pm 20%	1.55 (1.35)	43.00 (54.00)	35.00 (40.00)
CY1770AT125DS-1R5MC	1.50 \pm 20%	2.00 (1.70)	38.50 (48.00)	33.00 (37.50)
CY1770AT125DS-2R2MC	2.20 \pm 20%	2.65 (2.30)	31.00 (39.00)	30.00 (34.00)
CY1770AT125DS-3R3MC	3.30 \pm 20%	3.60 (3.10)	30.50 (38.00)	23.00 (26.00)
CY1770AT125DS-4R7MC	4.70 \pm 20%	4.95 (4.30)	24.50 (30.50)	21.00 (24.00)
CY1770AT125DS-5R6MC	5.60 \pm 20%	5.12 (4.45)	23.50 (29.40)	20.00 (23.00)
CY1770AT125DS-6R8MC	6.80 \pm 20%	7.55 (6.55)	22.50 (28.00)	18.00 (20.00)
CY1770AT125DS-8R2MC	8.20 \pm 20%	9.50 (8.20)	16.80 (21.00)	12.00 (13.50)
CY1770AT125DS-100MC	10.00 \pm 20%	10.50 (9.00)	15.00 (19.00)	10.50 (12.00)
CY1770AT125DS-150MC	15.00 \pm 20%	14.50 (12.50)	14.50 (18.50)	10.00 (11.50)
CY1770AT125DS-220MC	22.00 \pm 20%	21.00 (18.00)	12.50 (15.50)	8.00 (9.20)
CY1770AT125DS-330MC	33.00 \pm 20%	37.00 (32.00)	9.50 (12.00)	6.70 (7.50)
CY1770AT125DS-470MC	47.00 \pm 20%	47.00 (41.00)	7.00 (8.80)	5.60 (6.30)

※1 Measuring frequency Inductance at 100kHz, 0.25V

※2 Saturation current: This indicates the value of DC current when the inductance becomes 30% lower than its initial value.

※3 Temperature rise current: The value of DC current when the temperature of coil becomes $\Delta T=40^{\circ}\text{C}$ ($T_a=25^{\circ}\text{C}$).

※ The allowable current shall be defined smaller value of either the saturation current or the temperature rise current, when being generated DC current.

※ Within a suitable application, the part temperature depends on circuit design and certain heat dissipation conditions. This should be checked in a worst case operation mode. In normal case, the max standard operating temperature of $+125^{\circ}\text{C}$ should not be exceeded.

※ Absolute maximum voltage(across inductor): 50V

SMD Power Inductor

CY1770AT125/DS



回流焊耐热与推荐温度曲线图

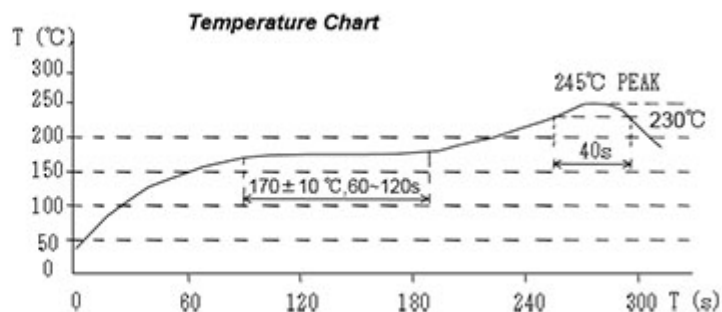
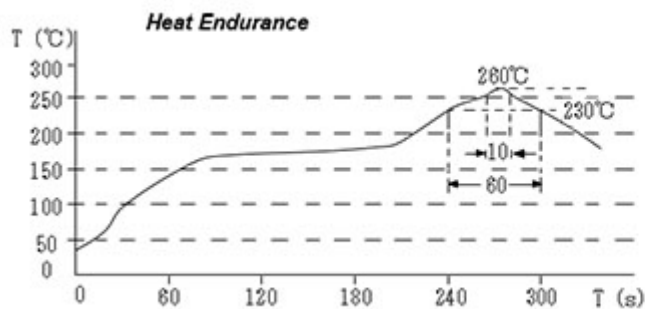

SMD Power Inductor

CY1770AT125/DS



直流饱和电流&温度上升曲线图

— L (25°C)

— ΔT

1. CY1770AT125DS-1R0MC

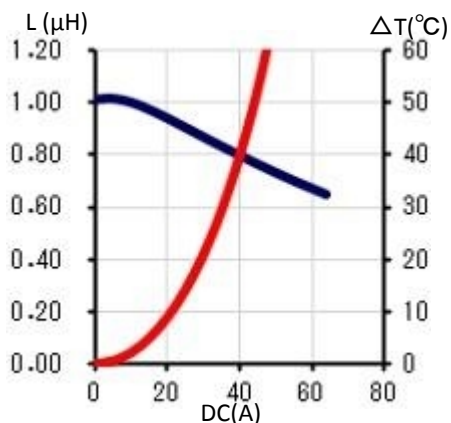

2. CY1770AT125DS-1R5MC

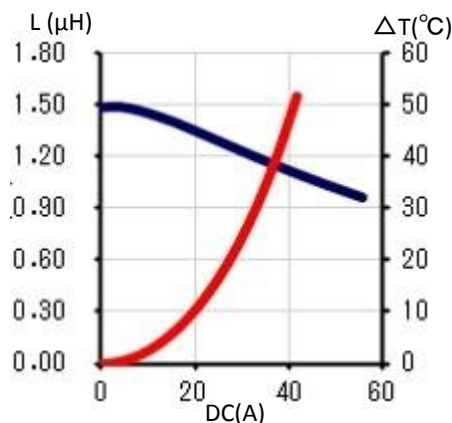

3. CY1770AT125DS-2R2MC

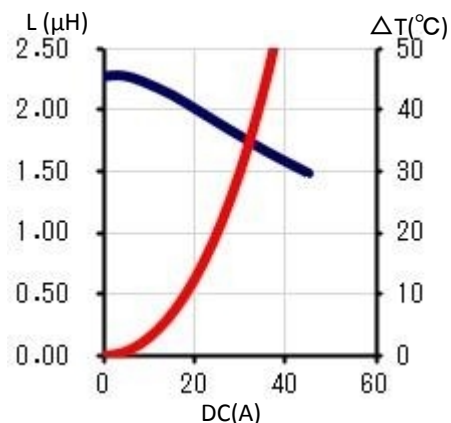

4. CY1770AT125DS-3R3MC

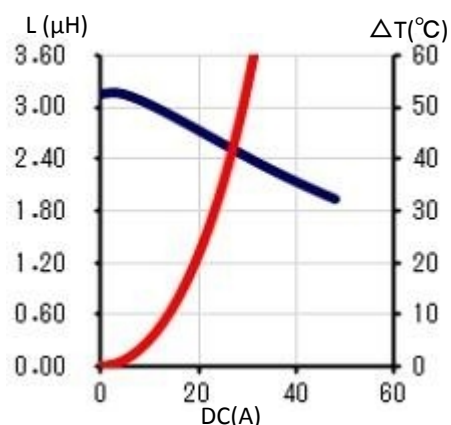

5. CY1770AT125DS-4R7MC

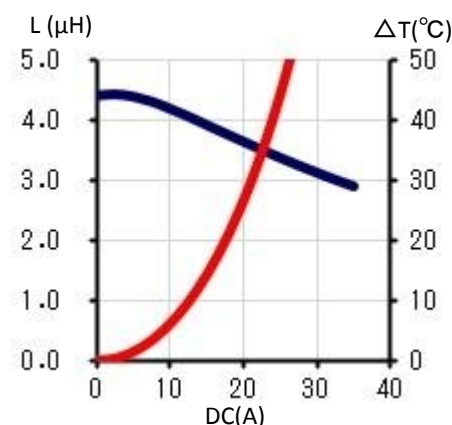

6. CY1770AT125DS-5R6MC

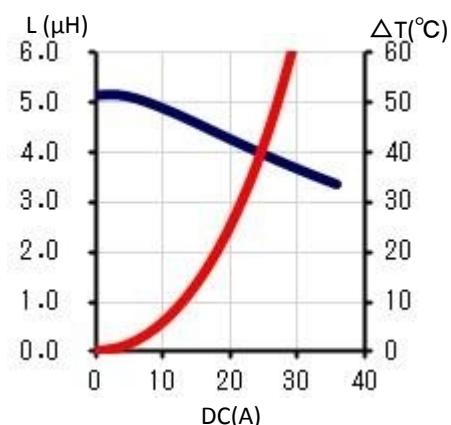

7. CY1770AT125DS-6R8MC

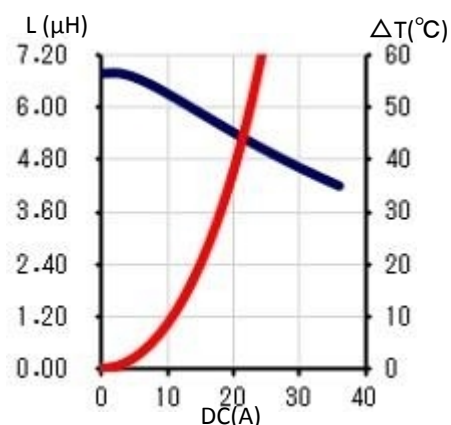

8. CY1770AT125DS-8R2MC

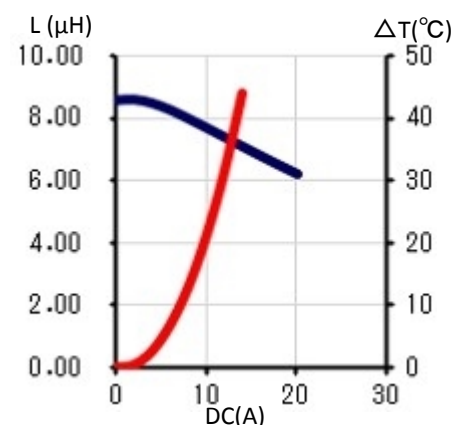

9. CY1770AT125DS-100MC

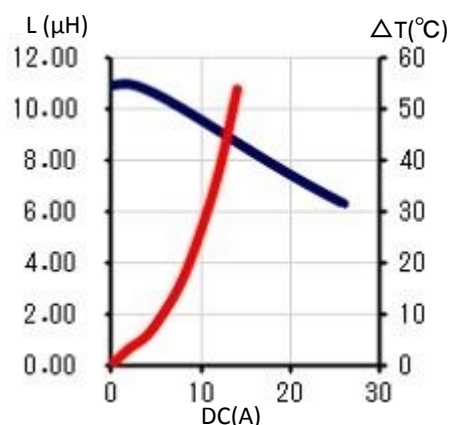

注：记载内容如有变更，恕不另行通知。订货时请联系您最近的销售办事处以获取最新产品信息。

SMD Power Inductor

CY1770AT125/DS



10. CY1770AT125DS-150MC

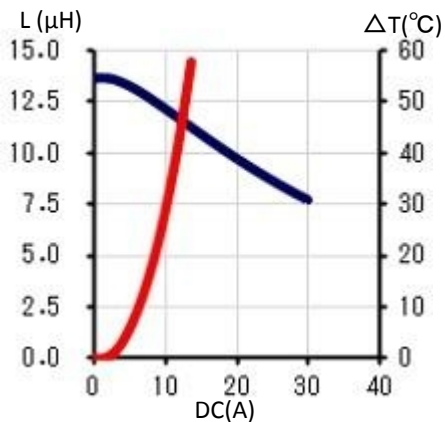

11. CY1770AT125DS-220MC

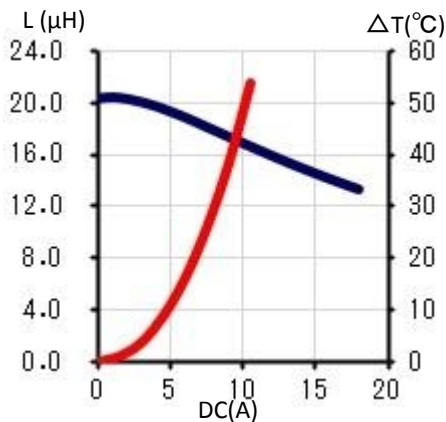

12. CY1770AT125DS-330MC

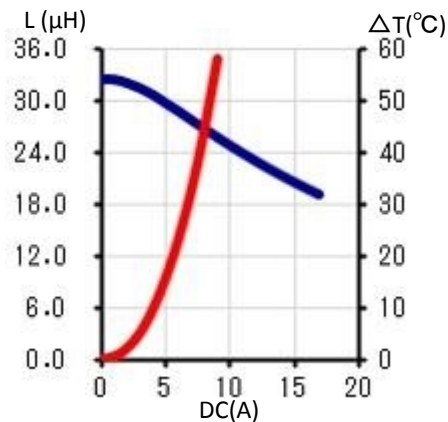

13. CY1770AT125DS-470MC

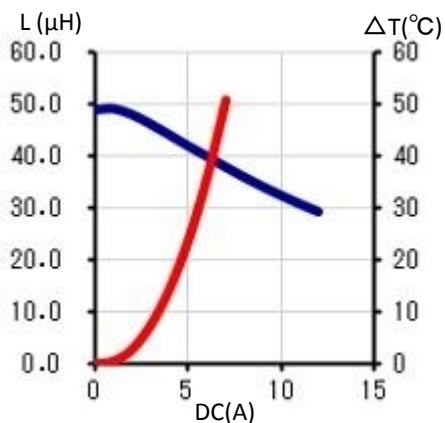

有关销售办事处的信息，请 [点击这里](#)。

X-ON Electronics

Largest Supplier of Electrical and Electronic Components

Click to view similar products for [Fixed Inductors](#) category:

Click to view products by [Sumida](#) manufacturer:

Other Similar products are found below :

[CR32NP-100KC](#) [70F224AI](#) [MHQ1005P10NJ](#) [MHQ1005P1N0S](#) [MHQ1005P2N4S](#) [MHQ1005P3N6S](#) [MHQ1005P5N1S](#) [MHQ1005P8N2J](#)
[PE-53601NL](#) [PE-53602NL](#) [PG0936.113NLT](#) [9220-20](#) [9310-16](#) [PM06-2N7](#) [PM06-39NJ](#) [A01TK](#) [1206CS-471XJ](#) [HC2-R47-R](#) [HC8-1R2-R](#)
[HCF1305-3R3-R](#) [1206CS-151XG](#) [RCH664NP-4R7M](#) [RCP1317NP-391L](#) [DH2280-4R7M](#) [DS1608C-106](#) [B10TJ](#) [B82498B3101J000](#) [ELJ-](#)
[RE27NJF2](#) [1812CS-153XJ](#) [1812CS-183XJ](#) [1812CS-223XJ](#) [1812LS-104XJ](#) [1812LS-105XJ](#) [1812LS-124XJ](#) [1812LS-154XJ](#) [1812LS-223XJ](#)
[1812LS-224XJ](#) [1812LS-563XJ](#) [1812LS-683XJ](#) [1812LS-824XJ](#) [NIN-FB101JTR110F](#) [NIN-FB471JTR62F](#) [NIN-FC1R5JTR220F](#) [NIN-](#)
[HCR15JTRF](#) [NIN-HCR33JTRF](#) [NIN-HDR22JTRF](#) [NIN-HDR82JTRF](#) [NIN-HK2N7STRF](#) [NIN-PA150KTR370F](#) [NIN-PB100KTR550F](#)