

Tooling – intro

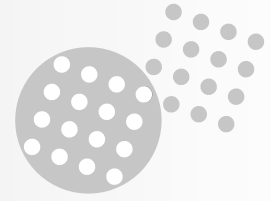

Overview TRIM TRIO tooling



Crimptooling for TRIM TRIO contacts

The TRIM TRIO connection system not only offers versatility in connectors but production versatility in tooling as well. All information needed on tooling ranges from simple handtools for small production, over semi-automatic to full automatic strip-and-crimp machines can be found on the hereafter paragraphs. All the TRIM TRIO tooling and this for machined, stamped and formed and coax contacts, is specially designed for this system to make reliable, trouble-free connections.

Tooling



Crimptooling for Size 16 contacts (Ø 1,6 mm)

For an overview on crimping refer to "crimping tables" at the different contact sections.



Weight: 425 gr.
Length: 250 mm.

M10S1 - for machined contacts

A robust, versatile, full cycling handtool which is fully qualified to the requirements of MIL-C-22520. Interchangeable 4-indent die sets are available for a wide range of machined contacts and gives a simultaneous crimp on both wire and insulation.

This tool is suitable for application of RM/RC machined contacts and coaxial from the TRIM TRIO range.

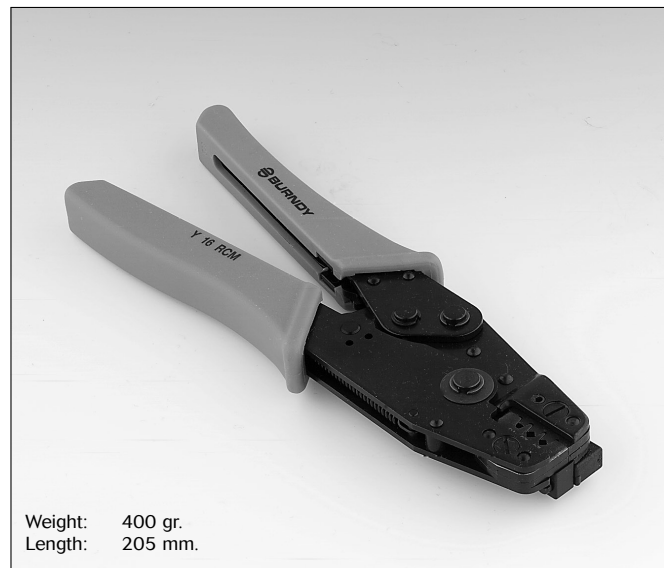

Weight: 400 gr.
Length: 205 mm.

Y16RCM - for machined contacts

A light weight, low cost crimping tool with fixed, 3-groove die set to crimp **Size 16 TRIM TRIO RM/RC loose piece machined contacts**.

The tool is ratchet controlled to guarantee a complete crimp cycle. Each crimping tool is supplied with a locator to guarantee a perfect crimp indent positioning.



Weight: 300 gr.
Length: 170 mm.

MH860 - for machined contacts

A light weight crimping tool Qualified to MIL-C-22520/7 that gives an 8 impression crimp with a precision cycle-controlled ratcheting mechanism. It features an 8 step crimp-depth selector knob and is designed to crimp **Size 16 TRIM TRIO RM/RC loose piece machined contacts**. The tool can be provided with different locator heads to crimp different contact types.



Weight: 425 gr.
Length: 250 mm.

AF8 - for machined contacts

Qualified to MIL-C-22520/1, has virtually limitless application within the specified wire range of 12 through 26 AWG. It gives an 8 impression crimp with a precision cycle-controlled ratcheting mechanism and **is used for certain machined power contacts and certain coax contacts**. The tool can be provided with different locator turret heads to crimp different contact types.

Tooling



Crimptooling for Size 16 contacts (Ø 1,6 mm)

For an overview on crimping refer to "crimping tables" at the different contact sections.



Weight: 340 gr.
Length: 220 mm

Y14SCM2 - for formed contacts

A low cost non ratchet plier type handtool for AWG26 to 16 + insulation crimp for:

Size 16 TRIM TRIO SM-M/SC-M loose piece formed contacts.

Size 20 SEALOK SM-W/SC-W loose piece formed contacts.

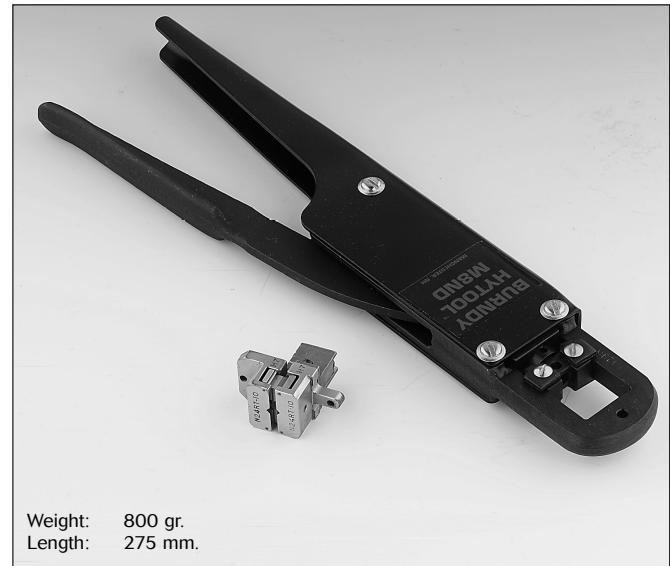

Weight: 800 gr.
Length: 275 mm.

M8ND - for machined and formed contacts

A robust full cycling hand ratchet tool which utilises interchangeable "N" die sets to crimp

Size 16 TRIM TRIO RM/RC loose piece machined contacts.

Size 16 TRIM TRIO SM-M/SC-M loose piece formed contacts.

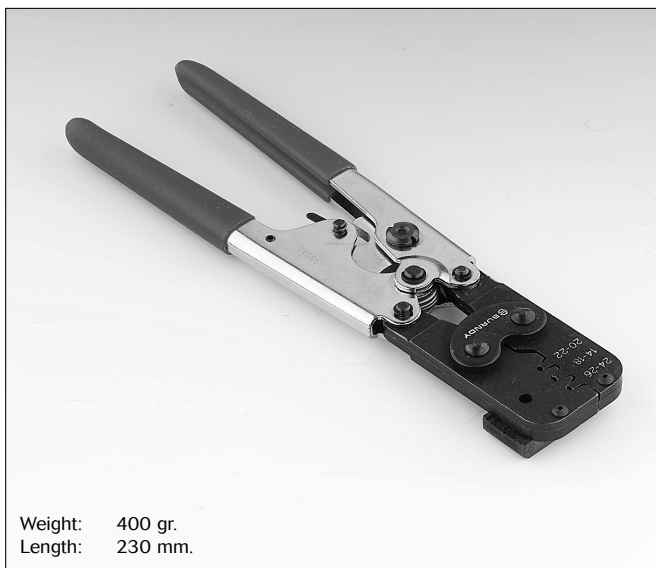

Weight: 400 gr.
Length: 230 mm.

Y14MTV - for formed contact

A light weight crimping tool with fixed 3-groove die set for AWG26 to 14 for: **Size 16 TRIM TRIO SM-M/SC-M loose piece formed contacts.**

Ratchet controlled to guarantee a complete crimp cycle.

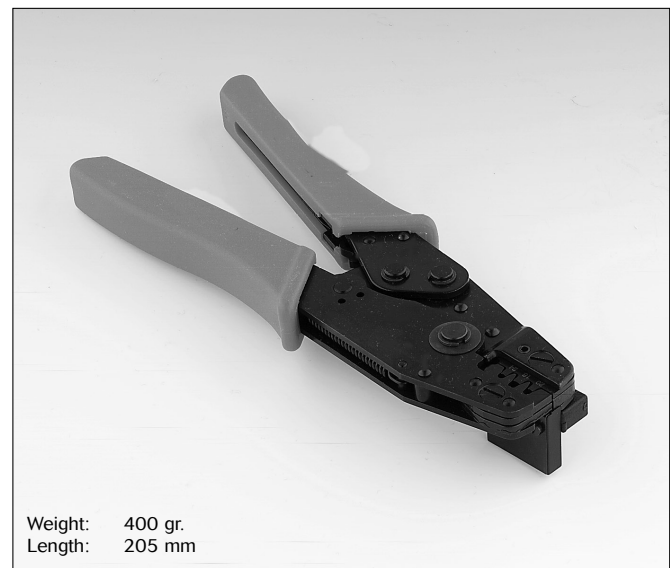

Weight: 400 gr.
Length: 205 mm

Y16SCM2 - for formed contacts

A light weight crimping tool with fixed 3-groove die set for AWG26 to 16 for:

Size 16 TRIM TRIO SM-M/SC-M loose piece formed contacts.

Ratchet controlled to guarantee a complete crimp cycle. Each crimping tool is supplied with a locator to guarantee a perfect crimp indent positioning.

Tooling



Crimptooling for Size 16 contacts (Ø 1,6 mm)

For an overview on crimping refer to “crimping tables” at the different contact sections.

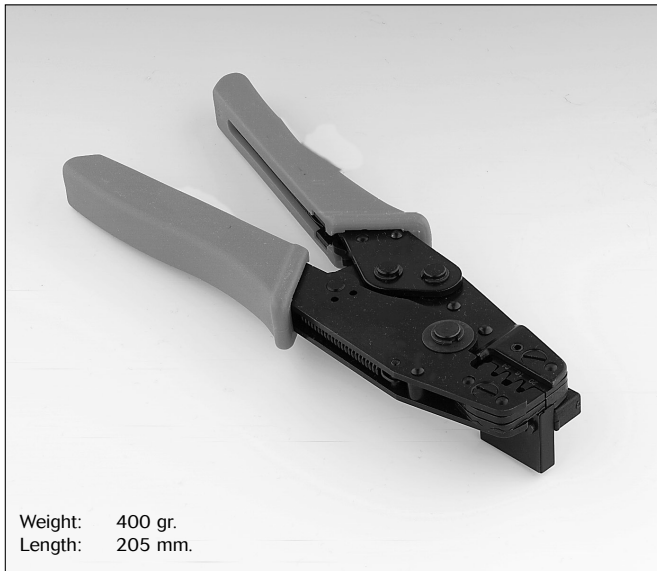

Y14SCM - for formed contacts

A light weight crimping tool with fixed 3-groove die set for AWG18 to 14 for:

Size 16 TRIM TRIO SM-M/SC-M loose piece formed contacts.

Ratchet controlled to guarantee a complete crimp cycle.

Each crimping tool is supplied with a locator to guarantee a perfect crimp indent positioning.

Tooling



Extraction and insertion tooling for size 16 contacts (Ø 1,6 mm)



RX2025GE1

A spring loaded extraction tool **for the full range of TRIM TRIO contacts**. This tool ensures that the contact locking louvres are fully retracted before any pressure is applied to extract a contact. Part number for extraction tip: RX2025GE1P4.



RX2025GE2

A low cost spring loaded extraction tool for the full range of **TRIM TRIO contacts**.



RX16D11D1

A spring loaded extraction tool **for the full range of TRIM TRIO contacts**. This tool ensures that the contact locking louvres are fully retracted before any pressure is applied to extract a contact. It is especially suitable for applications where the integrity of the assemblies are of the utmost importance.

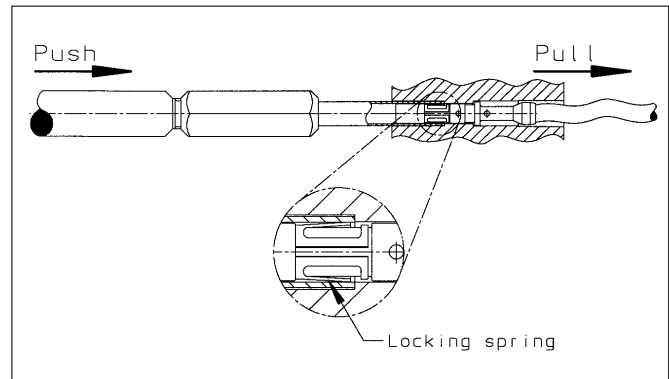

How to extract a contact out of its cavity?

Slide the extraction tip over contact from mating side till the locking spring from the contact is depressed. Push on handle to push out the contact with the spring loaded inner plunger.

Insertion tooling



RTM205

This tool is especially designed to ease insertion **of any TRIM TRIO contact** crimped on very flexible or small wire sizes. Simply position the insertion tool so that the tip of the tool bears against the back of the wire barrel, retaining the wire with thumb in the groove of the tool. Push the contact slowly into the connector until it snaps into position.

Tooling



Crimptooling for Size 20 contacts (Ø 1,0 mm)

For an overview on crimping refer to "crimping tables" at the different contact sections.



Weight: 300 gr.
Length: 170 mm.

MH860 - for machined contacts

A light weight crimping tool Qualified to MIL-C-22520/7 that gives an 8 impression crimp with a precision cycle-controlled ratcheting mechanism. It features an 8 step crimp-depth selector knob. The tool can be provided with different locator heads to crimp different contact types.



Weight: 340 gr.
Length: 220 mm

Y14SCM2 - for formed contacts

A low cost non ratchet plier type handtool for AWG26 to 16 + insulation crimp.

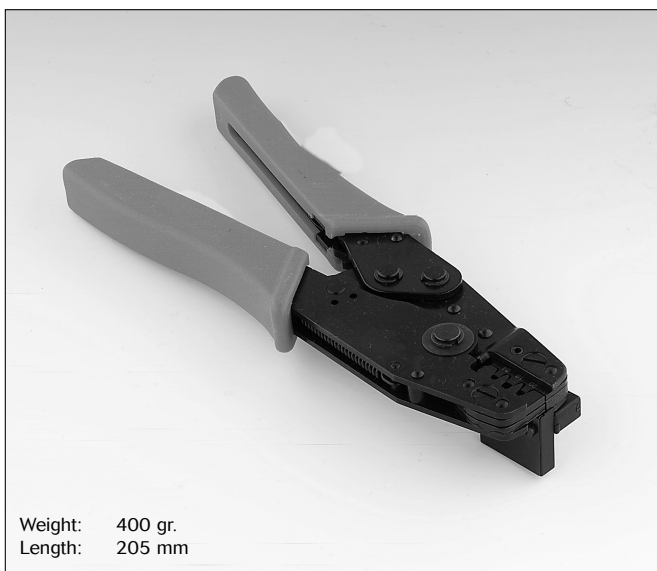

Weight: 400 gr.
Length: 205 mm

Y16SCM3 - for formed contacts

A light weight crimping tool with fixed 3-groove die set for AWG26 to 16 for:

Size 20 loose piece formed contacts.

Ratchet controlled to guarantee a complete crimp cycle.
Each crimping tool is supplied with a locator to guarantee a perfect crimp indent positioning.

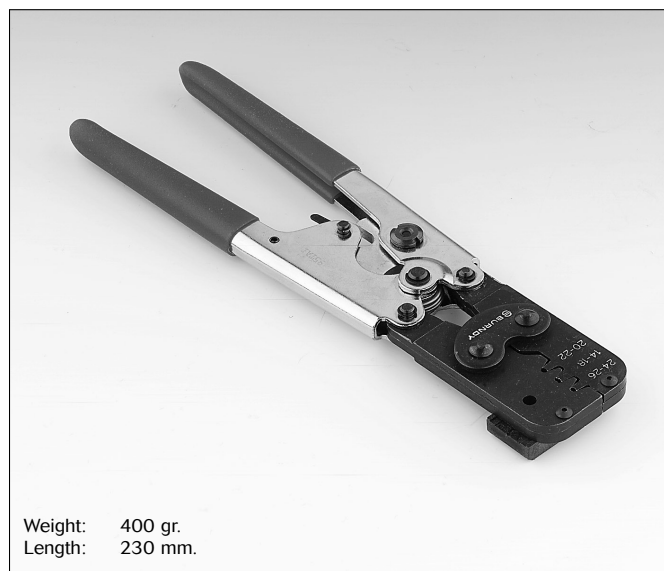

Weight: 400 gr.
Length: 230 mm.

Y14MTV - for formed contact

A light weight crimping tool with fixed 3-groove die set for AWG26 to 14. Ratchet controlled to guarantee a complete crimp cycle.

Tooling

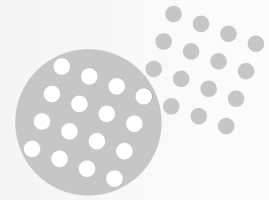

Extraction and insertion tooling for size 20 contacts (Ø 1,0 mm)



RX20D44

A spring loaded extraction tool. This tool ensures that the contact locking louvres are fully retracted before any pressure is applied to extract a contact. It is especially suitable for applications where the integrity of the assemblies are of the utmost importance.

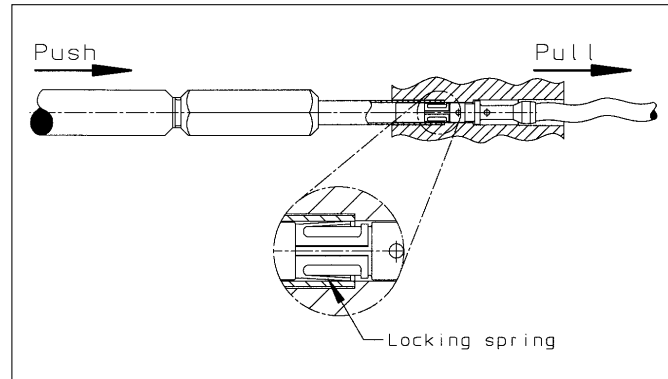

How to extract a contact out of its cavity?

Slide the extraction tip over contact from mating side till the locking spring from the contact is depressed. Push on handle to push out the contact with the spring loaded inner plunger.

Insertion tooling



RTM205

This tool is especially designed to ease insertion **of any contact** crimped on very flexible or small wire sizes. Simply position the insertion tool so that the tip of the tool bears against the back of the wire barrel, retaining the wire with thumb in the groove of the tool. Push the contact slowly into the connector until it snaps into position.

Tooling



Automatic crimping for size 16 (Ø 1,6 mm) and size 20 (Ø 1,0 mm) contacts

P100 MAN Press

This electromechanical high speed full automatic crimping press is specially designed for mass production and is realised totally in assembled steel parts.

The available force consents the crimping of a wire section up to 2.5mm².

The press has a 40mm stroke and can be used together with automatic cut and stripping machines.

It uses a new electronic module to control the bracking of the press at the desired point. The noise level of the press is less than 70dB. There is a safety mechanism that stops the press if the working speed is too high or the press does not complete its cycle. This protects the press or equipment mounted on board from damage.

Ref.: P100MAN
 Power.: 0.37 kWatt
 Weight: 35 kg
 Dimensions: 200x300x580

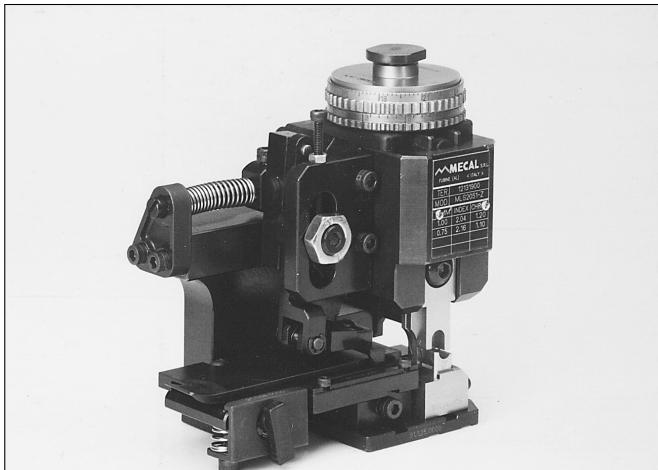

MLS--- Left side miniapplicator

Miniapplicator to crimp machined or stamped and formed TRIM TRIO and SEALOK contacts.

All the adjustments requested to make tool correctly functioning (crimp feeding pitch, crimp height...) can be simply made. Resolution of 0.03mm. Regulation range from 0 to 2.7 mm.

Ref.: See contact sections
 Stroke: 40 mm
 Weight: 4.5 kg
 Dimensions: 145x107x150

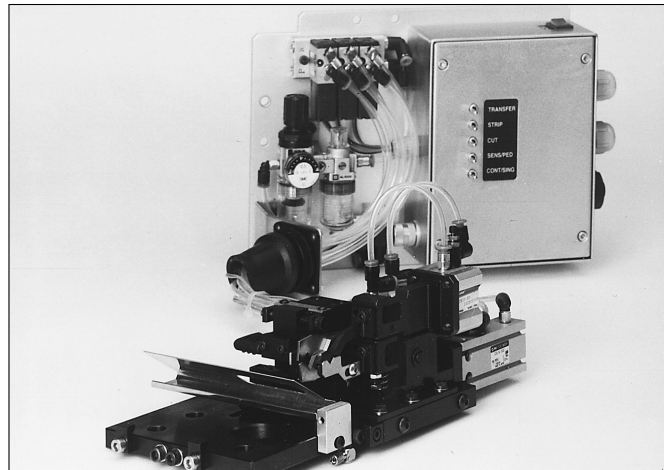

SC10S1 Stripper-crimper

This stripper unit is used to strip insulation, immediately before the crimping of the contact terminal. The stripper unit is totally separate from the miniapplicator that allows the execution in a way that the setup and trial of the stripper unit can be done independently.

Ref.: SC10S1
 Pressure: 5 - 7 bars
 Cable section: 0.2 - 3 mm²
 Stripping length: 2.5 - 12 mm
 Weight: 7.5 kg

Options

1 - Quality assurance for crimping technology...

A crimping force sensor continuously checks the quality of each individual crimp and records it without impairing the processing speed. The sensor detects bad crimp connections, eliminating the high subsequent costs otherwise caused by them.

For ordering consult factory

Options

2 - Crimp pull press gauge

The crimp pull press gauge allows to measure the resistance to the pulling of crimped terminals.

3 - Crimp height measuring device

4 - Kit press lighting lamp

For ordering consult factory

Tooling



Crimptooling & extraction tooling for power contacts:

Size 12 (dia. 2.4mm)

Size 8 (dia. 3.6mm)

Hand tooling for machined power contact # 12 (2,4 mm)



Crimp tooling M317 and locator VGE1 0077A

Extraction tooling for power contact # 12 (2,4 mm)

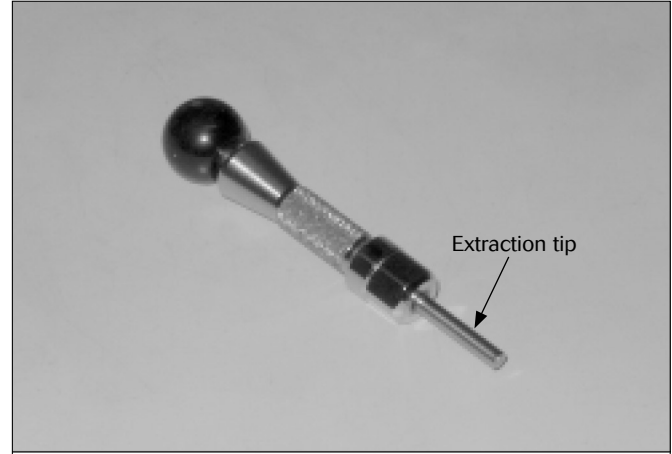

Extraction tooling 5106.021.09.24

Extraction tip: 5106.021.34.24

Handtooling for machined power contacts # 8 (3,6 mm)



Crimp tooling M317 and locator VGE1 0078A

Extraction tooling for contact # 8 (3,6 mm)

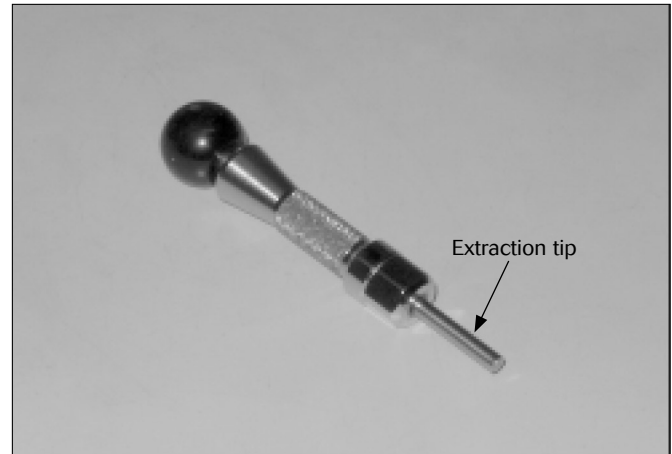

Extraction tooling 5106.021.09.36

Extraction tip: 5106.021.34.36

X-ON Electronics

Largest Supplier of Electrical and Electronic Components

Click to view similar products for [Extraction, Removal & Insertion Tools](#) category:

Click to view products by [Sunbank](#) manufacturer:

Other Similar products are found below :

[M8196914-08](#) [768211-2](#) [809-131](#) [844751-2](#) [8-59558-2](#) [91018-1](#) [12014013](#) [12093647](#) [1-21048-0](#) [R282867020](#) [12093078](#) [12180559](#) [1-21048-6](#) [12121897](#) [DCF.91.405.5LT](#) [1322](#) [15314260](#) [15350698](#) [15350707](#) [15430130](#) [1579018-4](#) [1643916-1](#) [1-679532-0](#) [1976593-3](#)
[OUTEXT-0321](#) [2-1579008-3](#) [2-1579008-4](#) [229694-7](#) [231106-1](#) [241469](#) [91040-3](#) [91040-7](#) [965004-000](#) [965069-000](#) [1738219-1](#) [ET-JL05-16](#)
[FG 0300 146 3000](#) [FIT-6](#) [210S048](#) [2-1579007-9](#) [231879-1](#) [312138-3](#) [RJ11FODE](#) [356-162](#) [M8196914-10](#) [4-1579018-0](#) [430395-001](#) [483249-1](#) [5-1579007-2](#) [5-1579007-9](#)