

SOURIAU

8ST Series

VG96912 & JN1003

8ST Series

VG96912 & JN1003



Contents

Overview

- 8ST Series - Presentation 06
- 8ST Series - Applications 06
- A universal product platform 07
- Contact layouts 08
- Contact layouts (matrix) 12
- Cross reference list 14

Standard Version

- Technical features 18
- Ordering information 19
- Dimensions 21
- Panel cut-out 24
- Mated/unmated dimensions 24
- Receptacle with straight PC tail contacts 25

Contacts & Tooling

- Straight PC tail contacts 28
- Crimp contacts 29
- Coaxial contacts #12 30
- Solder cup 30
- Quadrax #8 contacts 30
- Wire wrap contacts 31
- Thermocouple contacts 31

- Dummy contacts 32
- Filler plugs 32
- Wiring instructions 33
- Crimping tools 34
- Insertion & extraction tools 35
- Backshell tightening tools 35
- Tightening support 35
- Slackening tools 35

Common Section

- Backshells 38
- Protective caps 39
- Dummy receptacles 40
- Panel gasket 40
- Reductors 41
- Boots 41
- Orientations 41
- Coordinates information 42

Range Extension

- 8STA Series & 8STA derived Series 52
- 847/848 Series 53
- VGE1 Series 53
- micro38999 54
- 851 Series 54

OST Series



8ST Series

Overview

■ 8ST Series - Presentation	06
■ 8ST Series - Applications	06
■ A universal product platform: MIL-DTL-38999	07
■ Contact layouts	08
■ Contact layouts (matrix)	12
■ Cross reference list	14



8ST Series

VG96912 & JN1003

8ST Series - Presentation

VG96912 & JN1003

Derived from MIL-C-38999 Series I and II and incorporates lightweight, scoop proof and high contact density features. The design, performance and mechanical robustness of this product meet the requirements of the following applications:

- Military, aerospace,
- Ballistic missiles and weapon systems,
- Marine equipment.

8ST connector features include:

- A very high contact density,
- MIL-DTL-38999 Series I contact layouts,
- The male contacts are recessed into the body to prevent damage by mismatching (100% scoop proof),
- Keyway polarization (master keyway),
- RFI-EMI shielding and shell to shell continuity,
- Receptacle fixings and backshells as per pattern 602 and MIL-C-26482 Series II.

The plug and receptacle bodies, as the endbells, are manufactured from aluminum alloy and protected by cadmium or nickel plating. The shells are locked together by a bayonet coupling mechanism. Gold plated crimp or straight PC tail contacts are extracted from connector rear and are retained in the insulator by a metal clip.



8ST Series - Applications





A universal product platform: MIL-DTL-38999



38999 Series I: 8LT Series

- ▶ High density (#22D) MIL-spec circular
- ▶ Scoop proof
- ▶ Coupling system: Bayonet
- ▶ Method of mounting: screws or jam nut
- ▶ Shell: Aluminum alloy
- ▶ Plating: olive green cadmium, black zinc nickel or nickel
- ▶ QPL approved
- ▶ Numerous layouts



38999 Series II: 8T Series

- ▶ Short version of MIL-DTL-38999 Series I
- ▶ Low profile = lightweight
- ▶ High density MIL-spec circular (1980's)
- ▶ Non-scoop proof, bayonet coupling
- ▶ Method of mounting: screws or jam nut
- ▶ Shell: Aluminum alloy
- ▶ Plating: cadmium, nickel, hard anodized
- ▶ QPL approved
- ▶ Numerous layouts



38999 Series III: 8D Series

- ▶ High density MIL-spec circular (1980's)
- ▶ Scoop proof, fast screw coupling
- ▶ Composite light-weight version available
- ▶ QPL approved
- ▶ Titanium version, light-weight, mechanical and environmental performances
- ▶ Quadrax and Elio version
- ▶ Specific versions (clinch nuts, double flange, high power, hermetic, ...)

8ST Series

VG96912 & JN1003



Contact layouts

08

12^{HD}	35	98
12#26 Service R	6#22D Service M	3#20 Service I

- Contact #26 & #22D
- Contact #20
- Contact #16
- Contact #12
- Contact #10
- Contact #8
- Contact #8 Power
- Contact #8 Quadrax
- Contact #4 Power

10

01	02	04	05	26^{HD}	35	80	81
1#12 Service II	2#16 Service I	4#20 Service I	5#20 Service I	26#26 Service R	13#22D Service M	1#8 Triax Service I	1#8 Quadrax
98	99						
6#20 Service I	7#20 Service I						

12

03	04	08	26	35	43^{HD}	98
3#16 Service I	4#16 Service I	8#20 Service I	2#12 6#22D Service M	22#22D Service M	43#26 Service R	10#20 Service I

8ST Series

VG96912 & JN1003



Contact layouts

14

05 5#16 Service II	15 1#16 14#20 Service I	18 18#20 Service I	19 19#20 Service I	35 37#22D Service M	97 4#16 8#20 Service I
-------------------------------------	---	-------------------------------------	-------------------------------------	--------------------------------------	--

16

02 38#22D 1#8 Triax Service M	06* 6#12 Service I	08 8#16 Service II	20* 4#12 16#22D Service M	22 2#12 2#8 Triax Service M	26 26#20 Service I	35 55#22D Service M	75 2#8 Triax Service M
80 2#12 2#8 Quadrax	81 38#22D 1#8 Quadrax	82 2#8 Quadrax	99 2#16 21#20 Service I				

18

11 11#16 Service II	18 14#22D 4#8 Triax Service M	28 26#20 2#16 Service I	32 32#20 Service I	35 66#22D Service M	84 14#22D 4#8 Quadrax
--------------------------------------	---	---	-------------------------------------	--------------------------------------	--

8ST Series

VG96912 & JN1003



Contact layouts

20

11 11#12 Service I	16 16#16 Service II	35 79#22D Service M	39 2#16 37#20 Service I	41 41#20 Service I	42 2#4 Power Service I	48 4#8 Power Service I	72 2#4 Power 6#16 Service I
75 4#8 Triax Service M	77 17#22D 2#8 Triax Service M	78 17#22D 2#8 Quadrax	84 4#8 Quadrax				

22

21 21#16 Service II	32 32#20 Service I	35 100#22D Service M	53 53#20 Service I	54 4#12, 9#16 40#22D Service M	55 55#20 Service I
--------------------------------------	-------------------------------------	---------------------------------------	-------------------------------------	--	-------------------------------------

8ST Series

VG96912 & JN1003



Contact layouts

24							
<p>04</p> <p>8#16 48#20 Service I</p>	<p>07</p> <p>2#8 Triax 97#22D Service M</p>	<p>08*</p> <p>8#8 Triax Service M</p>	<p>19</p> <p>19#12 Service I</p>	<p>24</p> <p>12#16 12#12 Service I</p>	<p>29</p> <p>29#16 Service I</p>	<p>35</p> <p>128#22D Service M</p>	<p>37</p> <p>37#16 Service I</p>
<p>41</p> <p>22#22D, 3#20 11#16, 2#12 3#8 Triax Service M</p>	<p>43</p> <p>23#20 20#16 Service I</p>	<p>44</p> <p>4#4 Power 4#16 Service I</p>	<p>46</p> <p>40#20, 4#16 2#8 Coax Service I</p>	<p>61</p> <p>61#20 Service I</p>	<p>81</p> <p>22#22D 3#20, 11#16 2#12 3#8 Quadrax</p>	<p>82</p> <p>97#22D 2#8 Quadrax</p>	<p>86</p> <p>40#20 4#16 2#8 Quadrax</p>
<p>90</p> <p>40#20, 4#16 2#8 Twinax Service I</p>							

8ST Series

VG96912 & JN1003



Contact layouts (matrix)

Shell Size	Layout	Service	8ST	VG96912	JN1003		Nber of Contacts	#26	#22D	#20	#16	#12	#10	#8	#4 Power
					8ST2*034	Other P/N									
08	08-12	R					12	12							
	08-35	M		Q	Q	Q	6		6						
	08-98	I			Q	Q	3			3					
10	10-01	II					1					1			
	10-02	I				Q	2				2				
	10-04	I					4			4					
	10-05	I					5			5					
	10-26	R					26	26							
	10-35	M		Q	Q	Q	13		13						
	10-80	I				Q	1							1 Triax	
	10-81	-					1							1 Qdx	
	10-98	I		Q	Q	Q	6			6					
10-99	I					7			7						
12	12-01														
	12-03	I					3				3				
	12-04	I				Q	4				4				
	12-08	I					8			8					
	12-26	M					8		6			2			
	12-35	M		Q	Q	Q	22		22						
	12-43	R					43	43							
12-98	I		Q	Q	Q	10			10						
14	14-05	II		Q			5				5				
	14-15	I					15			14	1				
	14-18	I					18			18					
	14-19	I		Q	Q	Q	19			19					
	14-35	M		Q	Q	Q	37		37						
	14-97	I		Q	Q	Q	12			8	4				
16	16-02	M					39		38					1 Triax	
	16-06	I		Q		Q	6			6					
	16-08	II		Q		Q	8				8				
	16-20	M					20		16			4			
	16-22	M					4					2		2 Triax	
	16-26	I		Q		Q	26			26					
	16-35	M		Q	Q	Q	55		55						
	16-75	M					2							2 Triax	
	16-80	-					4					2		2 Qdx	
	16-81	-					39		38					1 Qdx	
16-82	-					2							2 Qdx		
16-99	I		Q			23			21	2					
18	18-11	II		Q		Q	11				11				
	18-18	M					18		14					4 Triax	
	18-28	I					28			26	2				
	18-32	I		Q		Q	32			32					
	18-35	M		Q	Q	Q	66		66						
	18-84	-					18		14					4 Qdx	

Souriau's layout

Q Qualified layout according corresponding norm

#8 Qdx: Quadrax

8ST Series

VG96912 & JN1003



Contact layouts (matrix)

Shell Size	Layout	Service	8ST	VG96912	JN1003		Nber of Contacts	#26	#22D	#20	#16	#12	#10	#8	#4 Power
					8ST2*034	Other P/N									
20	20-11	I				Q	11					11			
	20-16	II		Q	Q	Q	16				16				
	20-35	M		Q	Q	Q	79	79							
	20-39	I					39			37	2				
	20-41	I		Q		Q	41			41					
	20-42	I					2								2
	20-48	I					4							4 Pow	
	20-72	I					8				6				2
	20-75	-					4							4 Triax	
	20-77	M					19		17					2 Triax	
	20-78	-					19		17					2 Qdx	
20-84	-					4							4 Qdx		
22	22-21	II		Q		Q	21				21				
	22-32	I					32			32					
	22-35	M		Q	Q	Q	100	100							
	22-53	I				Q	53			53					
	22-54	M					53	40		9	4				
22-55	I					55			55						
24	24-04	I					56			48	8				
	24-07	M					99	97						2 Triax	
	24-08	-					8							8 Triax	
	24-19	I		Q		Q	19					19			
	24-24	II					24				12	12			
	24-29	I					29				29				
	24-35	M		Q	Q	Q	128	128							
	24-37	I					37				37				
	24-41	N					41	22	3	11	2			3 Triax	
	24-43	I					43			23	20				
	24-44	I					8				4				4
	24-46	I					46			40	4			2 Coax	
	24-61	I		Q		Q	61			61					
	24-81	N					41	22	3	11	2			3 Qdx	
24-82	M					99	97						2 Qdx		
24-86	I					46			40	4			2 Qdx		
24-90	I					46			40	4			2 Triax		

Souriau's layout

Q Qualified layout according corresponding norm

#8 Pow: Power; Qdx: Quadrax

8ST Series

VG96912 & JN1003



Cross reference list

VG: approval n°307/84

Pr EN3372

JN1003: full qualification under process.

Connectors	SOURIAU	VG96912	EN3372*	JN1003 (EFA)*	Designation	
	8ST0**G**P/SN 8ST0**F/B**P/SN 8ST0**B**P/SN034 8ST0**B**A/BN034	VG96912A****P/SN - - -	- EN3372F/W0**N**P/SN - -	- - - -	- - JN1003B****P/SN1 JN1003B****P/SN	Square flange receptacle
	8ST1**F/G**P/SN	-	-	-	In line receptacle	
	8ST2**B**P/SN034 8ST2**F/A/BN034	- -	- -	JN1003H****P/SN1 JN1003H****P/SN	Mounting box receptacle	
	8ST5**G**P/SN 8ST5**F/B**P/SN 8ST5**B**P/SN034 8ST5**B**A/BN034	VG96912D****P/SN - - -	- EN3372F/W6**N**P/SN - -	- - JN1003FG****P/SN1 JN1003FG****P/SN	Plug with EMI/RFI shielding	
	8ST6**G**P/SN 8ST6**F/B**P/SN	VG96912E****P/SN -	- -	- -	Plug without EMI/RFI shielding	
	8ST7**G**P/SN 8ST7**F/B**P/SN 8ST7**B**P/SN034 8ST7**F/B**A/BN034	VG96912B****P/SN - - -	- EN3372F/W7**N**P/SN - -	- - JN1003A****P/SN1 JN1003A****P/SN	Jam nut receptacle	

* Please consult us, our product will be evaluated against the final drafts/standards when available.

Contacts	SOURIAU	VG96912	EN3372*	JN1003 (EFA)*	Designation	
	8599-0702 JJ 8599-0703 SA 8599-0704 MJ 8599-0705 MJ	VG96912P22 D VG96912P20 VG96912P16 VG96912P12	- Separate EN standard in progress - -	- - - -	- - - -	Crimp male contact #22D Crimp male contact #20 Crimp male contact #16 Crimp male contact #12
	8599-0706 900 8599-0707-900 8599-0708-900 8599-0709-900	VG96912S22D1 VG96912S201 VG96912S161 VG96912S121	- Separate EN standard in progress - -	- - - -	- - - -	Crimp female contact #22D Crimp female contact #20 Crimp female contact #16 Crimp female contact #12
	M39029/58-360 M39029/58-363 M39029/58-364 M39029/58-365	- - - -	- - - -	- - - -	JN1003P22D JN1003P20 JN1003P16 JN1003P12	Crimp male contact #22D Crimp male contact #20 Crimp male contact #16 Crimp male contact #12
	M39029/58-348 M39029/58-351 M39029/58-352 M39029/58-353	- - - -	- - - -	- - - -	JN1003S22D JN1003S20 JN1003S16 JN1003S12	Crimp female contact #22D Crimp female contact #20 Crimp female contact #16 Crimp female contact #12

* Please consult us, our product will be evaluated against the final drafts/standards when available.

8ST Series

VG96912 & JN1003



Cross reference list

VG: approval n°307/84

Pr EN3372

JN1003: full qualification under process.

	SOURIAU	VG96912	EN 3372*	JN1003 (EFA)*	Designation
Backshells	8LST101B52 (shell size 08)	-			Straight endbell cable clamp
	8LST102B52 (shell size 10)	VG96912G110			
	8LST103B52 (shell size 12)	VG96912G112			
	8LST104B52 (shell size 14)	VG96912G114	Separate EN standard in progress		
	8LST105B52 (shell size 16)	VG96912G116			
	8LST106B52 (shell size 18)	VG96912G118			
	8LST107B52 (shell size 20)	VG96912G120			
	8LST108B52 (shell size 22)	VG96912G122			
	8LST109B52 (shell size 24)	VG96912G124			
	8LST101B57 (shell size 08)	-			
	8LST102B57 (shell size 10)	VG96912L110			
	8LST103B57 (shell size 12)	VG96912L112			
	8LST104B57 (shell size 14)	VG96912L114	Separate EN standard in progress		
	8LST105B57 (shell size 16)	VG96912L116			
	8LST106B57 (shell size 18)	VG96912L118			
	8LST107B57 (shell size 20)	VG96912L120			
	8LST108B57 (shell size 22)	VG96912L122			
8LST109B57 (shell size 24)	VG96912L124				

* Please consult us, our product will be evaluated against the final drafts/standards when available.

OST Series



8ST Series

Standard Version

■ Technical features	18
■ Ordering information	19
■ Dimensions	21
■ Panel cut-out	24
■ Mated/unmated dimensions	24
■ Receptacle with straight PC tail contacts	25



8ST Series

VG96912 & JN1003



Description

- A high density connector from 1 to 128 contacts for all military and aeronautical purposes.
- Contact sizes #22D, #20, #16, #12, #16 coax, #8 triax, #8 and #4 power
- Bayonet locking system
- MIL-DTL-38999 Series I contact layouts
- 100% scoop proof
- EMI/RFI shielding and shell-to-shell continuity
- Standards: JN 1003, VG 96912, pr EN 3372, EFA J 62-017

Technical features

Mechanical

- Shell: aluminum alloy
- Plating:
 - . black zinc nickel (Z)
 - . olive green cadmium (G)
 - . olive green cadmium, spec. 034
 - . 500 hours salt spray (B)
 - . nickel (F)
- Insulator: thermoplastic or metallic version available for specification 284 & 384
- Grommet or seal: liquid silicone rubber or fluorocarbene elastomer for specification 022
- Contact: copper alloy
- Plating contact: gold over nickel
- Endurance: 500 mating/unmating operations
- Shock: 300 g during 3 ms and as per MIL S 901 grade A
- Vibration: 147 m/s², 10 to 2000 Hz
- Contact retention (min force in N):

Contacts size	22	20	16	12	8	4
Min force in N	45	67	111	111	110	200

Electrical

- Test voltage (Vrms)

Service	sea level	at 21000 m
R	400	N/A
M	1 300	800
N	1 000	600
I	1 800	1 000
II	2 300	1 000

- Insulation resistance:
≥ 5 000 MW at 500 VAC

- Contact resistance:

Contacts size	26	22	20	16	12	8	4
Resistance mΩ	16	14.6	7.3	3.8	3.5	3	2

- Contact rating:

Contacts size	26	22	20	16	12	8	4
Rating (A)	3	5	7.5	13	23	45	80

- Shell continuity:
 - . black zinc nickel: 2.5 mΩ
 - . olive green plating: 2.5 mΩ
 - . nickel plating: 1 mΩ
- Shielding: 70 db at 0.01 to 100 MHz

- Electrical continuity between contact and shell for specification 284 & 384: 10 mΩ max

Climatic

- Temperature range:
 - . black zinc nickel plating (Z)
- 65°C +175°C
 - . olive green cadmium plating (B or G)
- 65°C +175°C
 - . nickel plating (F)
- 65°C +200°C
- Sealing, mated connectors: Differential pressure 2 bars leakage ≤16 cm³/h
- Salt spray as per:
 - . MIL STD 1344 method 1001:
- 500 hours (plating B, G and Z)
- 48 hours (plating F)
 - . NFC 93422 :
- 48 hours (plating F)
- Resistance to fluids
 - . As per MIL-DTL-38999:
MIL-L-7808, MIL-L-23699, MIL-H-5606, MIL-A-8243, MIL-C-25769, MIL-T-5624 (JP5), hydraulic fluids, solvents
 - . Specification 022 for fuel immersion (please consult us)

8ST Series

VG96912 & JN1003



Ordering information

SOURIAU part numbers

Basic series	8ST	0	-	10	G	35	P	N
Shell style								
0: Square flange receptacle								
1: In line receptacle								
2: Square flange receptacle, not accepting backshell								
3: Square flange receptacle, rear mounting								
5: Plug with RFI/EMI shielding								
6: Plug without RFI/EMI shielding								
7: Jam nut receptacle								
Type								
-: Connector with standard crimp contacts								
L: Connector with long PC tail contacts								
M: Connector with medium PC tail contacts								
C: Connector with short PC tail contacts								
Shell size								
08; 10; 12; 14; 16; 18; 20; 22; 24								
Plating								
Z: Black zinc nickel								
F: Nickel								
G: Olive green cadmium								
B: Olive green cadmium - spec. 034 mandatory, see specification below								
Contact layout								
See pages 8 to 13								
Contact type								
P: Pin								
S: Socket								
A: Connector supplied without pin contact								
B: Connector supplied without socket contact								
Orientation								
N, A, B, C, D - See page 41; Orientations B & C not developed for shell size number 8								
Specifications								
None: Supplied with contact								
034: As per JN1003 Standard - B type plating only, 500 hours salt spray								
046: PC Tail contact with tinned plating								
251: Connector provided with #8 power contacts instead of #8 triax contacts								
022: Fuel tank - Please consult us								



8ST Series

VG96912 & JN1003

Ordering information

JN1003 part numbers

Basic series	JN1003	B	12	-	35	P	N	1
Shell style								
A: Jam nut receptacle								
B: Square flange receptacle								
FG: Plug with RFI/EMI shielding								
H: Square flange receptacle, not accepting backshell								
Shell size								
08; 10; 12; 14; 16; 18; 20; 22; 24								
Plating								
-: Olive green cadmium								
Contact layout								
See pages 8 to 13								
Contact type								
P: Pin								
S: Socket								
Orientation								
N, A, B, C, D - See page 41; Orientations B & C not developed for shell size number 8								
Specification								
None: Delivered without contact - crimp version								
1: Delivered with crimp contacts								
101: Short PC tail contacts (#22D, #20, #16 male & female for receptacle type A and B)								
102: Medium PC tail contacts (#22D male for receptacle B ; #22D and #20 female for receptacle type A)								
103: Long PC tail contacts (#22D male & female for receptacle type B)								
104: Short PC tail contacts HE308 type (#22D male & female for receptacle type B)								

VG96912 part numbers

Basic series	VG96912	D	10	-	35	P	N
Shell type							
A: Square flange receptacle							
AA: Square flange receptacle, rear mounting							
B: Jam nut receptacle							
D: Plug with RFI/EMI shielding							
E: Plug without RFI/EMI shielding							
Shell size							
08; 10; 12; 14; 16; 18; 20; 22; 24							
Plating							
-: Olive green cadmium							
Contact layout							
See pages 8 to 13							
Contact type							
P: Pin							
S: Socket							
Orientation							
N, A, B, C, D - See page 41; Orientations B & C not developed for shell size number 8							

8ST Series

VG96912 & JN1003



Dimensions

Types 5 & 6 - Plug

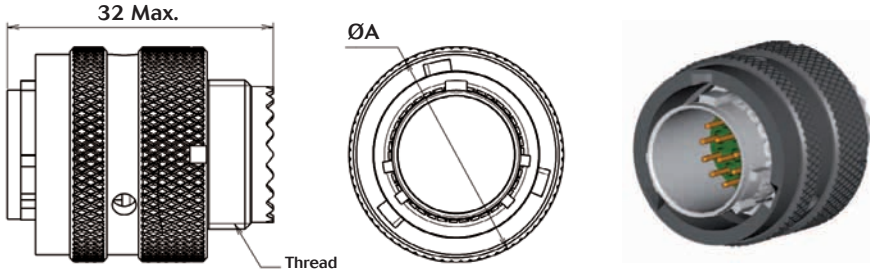

Shell size	A	Thread
08	19	7/16-28 UNEF 2A
10	22	9/16-24 UNEF 2A
12	26	11/16-24 UNEF 2A
14	29	13/16-20 UNEF 2A
16	33	15/16-20 UNEF 2A
18	36	1" 1/16-18 UNEF 2A
20	39	1" 3/16-18 UNEF 2A
22	44	1" 5/16-18 UNEF 2A
24	46	1" 7/16-18 UNEF 2A

Type 7 - Jam nut receptacle

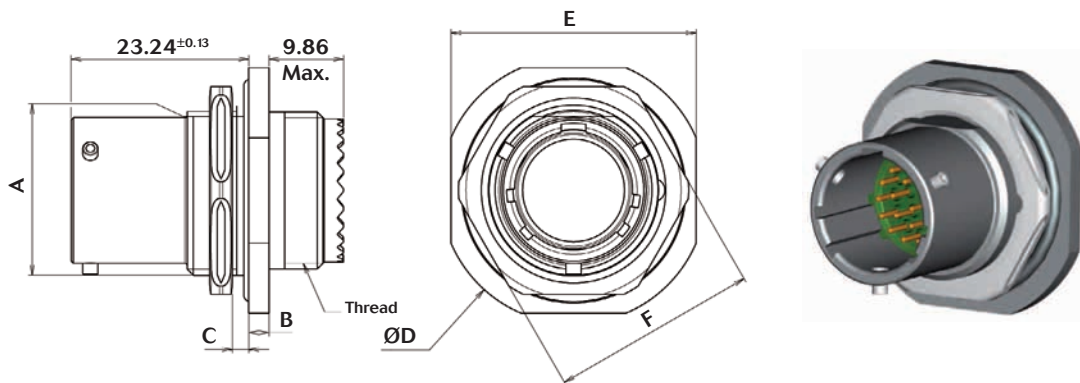

Shell size	A ± 0.2	B	C	Thread	ØD	E ± 0.3	F ± 0.4	Tightening torque for JN1003 (mN)
08	13.46	2.43 / 3.09	1.6 / 3.2	9/16-24 UNEF 2A	27.3	23.8	19.1	4
10	16.64			11/16-24 UNEF 2A	30.5	27.0	22.2	6
12	20.78			13/16-20 UNEF 2A	35.3	31.8	27.0	9
14	23.93			15/16-20 UNEF 2A	38.4	34.9	30.2	10
16	27.08	3.23 / 3.89		1" 1/16-18 UNEF 2A	41.6	38.1	33.3	13
18	30.25			1" 3/16-18 UNEF 2A	44.8	41.3	36.5	20
20	33.43			1" 5/16-18 UNEF 2A	49.6	46.0	39.7	23
22	36.60			1" 7/16-18 UNEF 2A	52.7	49.2	42.7	25
24	39.78		1" 7/16-18 UNEF 2A	55.9	52.4	46.0	26	

Note: All dimensions are in millimeters (mm)

8ST Series

VG96912 & JN1003



Type 0 - Square flange receptacle

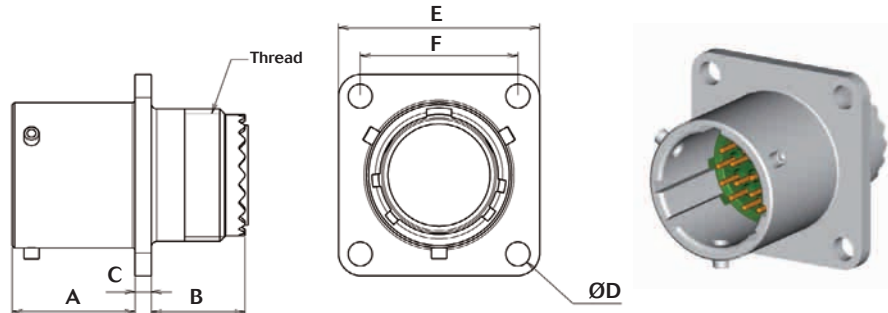

Shell size	A ± 0.2	B Min.	C	Thread	ØD ± 0.13	E ± 0.4	F ± 0.1
08	16.05	11.8	2.16 / 2.42	7/16-28 UNEF 2A	3.05	20.6	15.1
10				9/16-24 UNEF 2A		23.8	18.3
12				11/16-24 UNEF 2A		26.2	20.6
14				13/16-20 UNEF 2A		28.6	23.0
16				15/16-20 UNEF 2A		31.0	24.6
18				1" 1/16-18 UNEF 2A		33.3	27.0
20	15.29	11.8	2.92 / 3.18	1" 3/16-18 UNEF 2A	3.73	36.5	29.4
22				1" 5/16-18 UNEF 2A		39.7	31.8
24				1" 7/16-18 UNEF 2A		42.9	34.9

Type 1 - In line receptacle

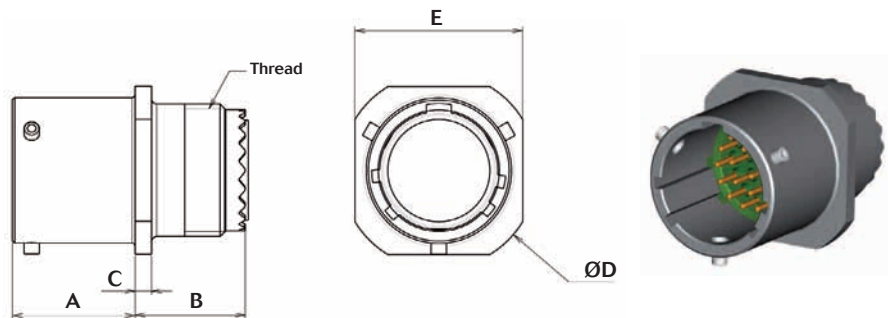

Shell size	A ± 0.2	B Min.	C	Thread	ØD ± 0.1	E ± 0.4
08	16.05	11.8	2.16 / 2.42	7/16-28 UNEF 2A	7.45	14.2
10				9/16-24 UNEF 2A	10.7	18.5
12				11/16-24 UNEF 2A	13.6	21.8
14				13/16-20 UNEF 2A	16.75	25.2
16				15/16-20 UNEF 2A	19.95	27.4
18				1" 1/16-18 UNEF 2A	22.2	31.0
20	15.29	11.8	2.92 / 3.18	1" 3/16-18 UNEF 2A	25.35	34.2
22				1" 5/16-18 UNEF 2A	28.55	37.6
24				1" 7/16-18 UNEF 2A	31.7	41.6

Note: All dimensions are in millimeters (mm)

8ST Series

VG96912 & JN1003



Type 2 - Square flange receptacle (not accepting backshell)

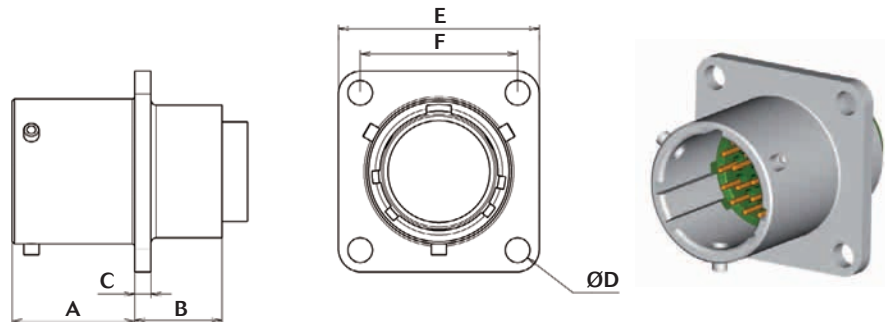

Shell size	A ± 0.2	B Min.	C	$\text{ØD} \pm 0.13$	E ± 0.4	F ± 0.1
08	16.05	11.2	2.16 / 2.42	3.05	20.6	15.1
10					23.8	18.3
12					26.2	20.6
14					28.6	23.0
16					31.0	24.6
18					33.3	27.0
20	15.29	12.0	2.92 / 3.18	3.73	36.5	29.4
22					39.7	31.8
24					42.9	34.9

Type 3 - Square flange receptacle (rear mounting)

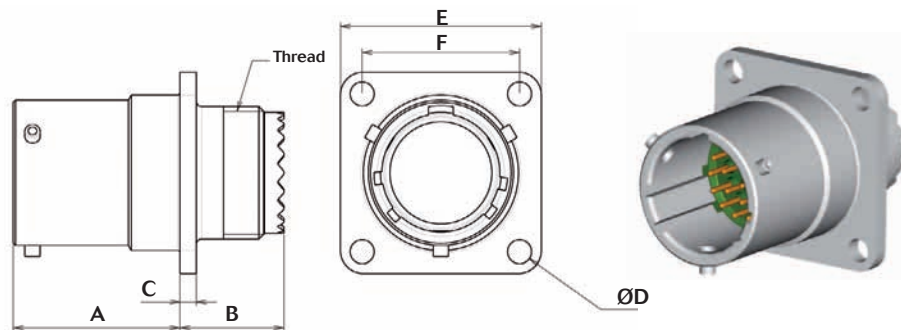

Shell size	A ± 0.2	B Min.	C	Thread	$\text{ØD} \pm 0.13$	E ± 0.4	F ± 0.1
08	21.84	13.5	2.16 / 2.42	7/16-28 UNEF 2A	3.05	20.6	15.1
10				9/16-24 UNEF 2A		23.8	18.3
12				11/16-24 UNEF 2A		26.2	20.6
14				13/16-20 UNEF 2A		28.6	23.0
16				15/16-20 UNEF 2A		31.0	24.6
18				1"1/16-18 UNEF 2A		33.3	27.0
20				1"3/16-18 UNEF 2A		36.5	29.4
22				1"5/16-18 UNEF 2A		39.7	31.8
24	25.4	12.3	1"7/16-18 UNEF 2A	3.73	42.9	34.9	

Note: All dimensions are in millimeters (mm)

8ST Series

VG96912 & JN1003



Panel cut-out

Types 0, 2 & 3

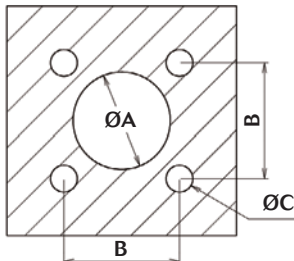

Type 7

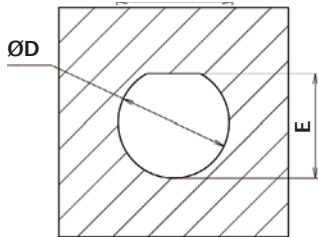

Shell size	Types 0, 2 & 3			Type 7		
	ØA ^{+0.25} ₋₀		B	ØC ^{+0.25} ₋₀	ØD ^{+0.25} ₋₀	E ^{+0.25} ₋₀
	Back panel mounting	Front panel mounting				
08	14	12.7	15.1	3.5	14.5	13.6
10	17	16	18.3		17.7	16.8
12	22	19	20.6		22.7	20.9
14	25	22.2	23.0		25.7	24.1
16	28	25.5	24.6		28.8	27.2
18	31	28.5	27.0		32.0	30.4
20	34.5	31.7	29.4		35.1	33.6
22	37.5	35	31.8		38.4	36.8
24	41	38	34.9	4	41.5	39.9

Mated/unmated dimensions

Types 8ST5 & 8ST6
with types 8ST0/8ST1/8ST2

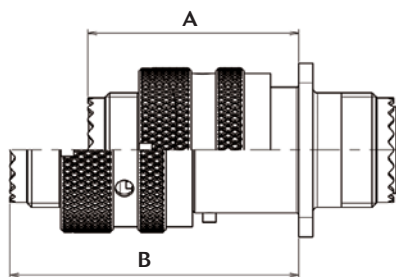

Types 8ST5 & 8ST6
with type 8ST3

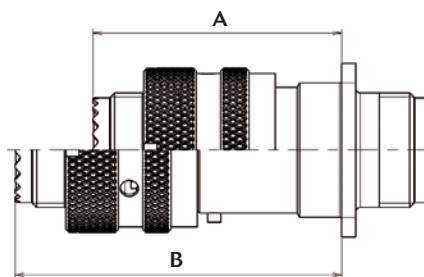

Types 8ST5 & 8ST6
with type 8ST7

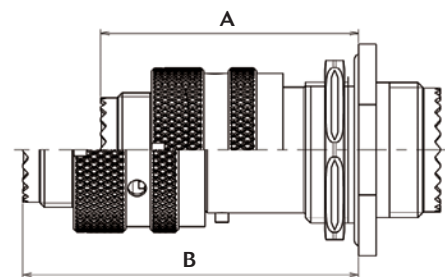

Shell size	A Max.	B Max.	C Max.	D Max.	E Max.	F Max.
08	31.93	46.99	37.72	52.78	39.24	54.30
10						
12						
14						
16						
18	31.17	46.23	41.28	56.34		
20						
22						
24						

Note: All dimensions are in millimeters (mm)

8ST Series

VG96912 & JN1003



Receptacle with straight PC tail contacts

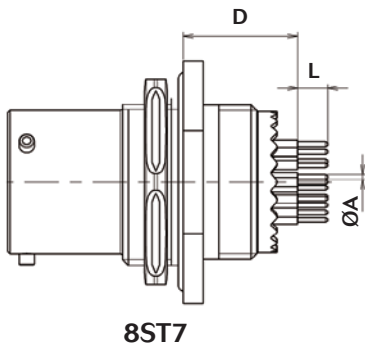
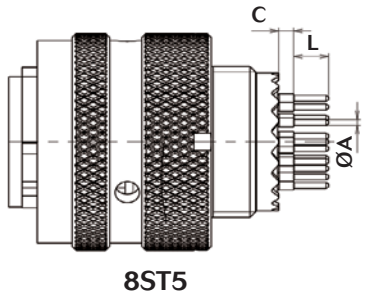
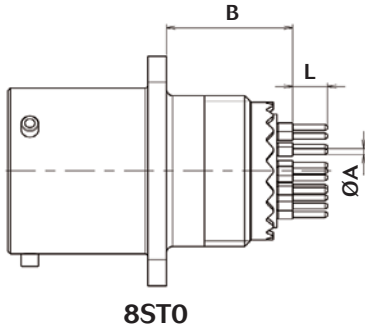

	Contact style			Shell type	
	Size	Type	Length	8ST0/8ST5	8ST7
ØA Max.	#22D / #20	P / S	L / C	0.7	-
		P / S	C	-	0.66
	#22D	P	M	0.5	0.66
	#20	S	M	-	0.66
	#16	P	L	1.66	-
	#16	P / S	C	1.15	1.15
L	#22D / #20	P / S	L	8.5 ^{+0.2}	-
		P	L	5.3 ^{±0.1}	-
	#22D	P / S	C	4 ⁺⁰ _{-0.2}	-
	#20 / #16 / #12	P / S	C	5 ^{±0.1}	-
	#22D	P	M	6 ^{±0.1}	6.5 ⁺⁰ _{-0.2}
	#22D / #20 / #16	P / S	C	-	4 ^{±0.1}
B	#22D	P / S	L / C	14.07 / 15.06	
		P	M	14.24 / 15.23	
	#20	P / S	L	14.07 / 15.06	
			C	14.24 / 15.23	
	#16	P	L	18.62 / 19.61	
	#16 / #12	P / S	C	14.24 / 15.23	
C	#22D	P / S	L / C	1.43 / 2.23	
		P	M	1.60 / 2.40	
	#20	P / S	L	1.43 / 2.23	
			C	1.60 / 2.40	
	#16	P	L	5.98 / 6.78	
	#16 / #12	P / S	C	1.60 / 2.40	
D	#22D	P	M	13.86 / 14.86	
	#20	S	M	13.86 / 14.86	
	#22D / #20 / #16	P / S	C	14.79 / 15.79	

Note: All dimensions are in millimeters (mm)

OST Series



8ST Series

Contacts & Tooling

■	Contacts:	
	Straight PC tail contacts	28
	Crimp contacts	29
	Coaxial contacts #12	30
	Solder cup	30
	Quadrax #8 contacts	30
	Wire wrap contacts	31
	Thermocouple contacts	31
	Dummy contacts	32
	Filler plugs	32
■	Wiring instructions	33
■	Tooling:	
	Crimping tools	34
	Insertion & extraction tools.....	35
	Backshell tightening tools	35
	Tightening support.....	35
	Slackening tools	35
	Tightening of fixing nuts, receptacle type 7	35

8ST Series

VG96912 & JN1003



Straight PC tail contacts









Shell type	Contact length	Contact size	Contact type	SOURIAU Part Number (no color code)	Profile	
8ST0 8ST5	L	#22D	P	8599-0720		
			S	8599-0721		
		#20	P	8599-0771		
			S	8599-0772		
		#16	P	8599-7496A		
		C	#22D	P	8599-0730	
	S			8599-0731		
	#20		P	8599-0724		
			S	8599-0725		
	#16		P	8599-0726		
			S	8599-0727		
	#12		P	8599-7929		
			S	8599-7932		
	M	#22D	P	8599-8028		
	8ST7	C	#22D	P	8599-0779	
				S	8599-0788	
			#20	P	8599-0780	
				S	8599-0789	
#16			P	8599-7711		
			S	8599-7710		
M		#22D	P	8599-0728		
		#20	S	8599-0786		

8ST Series

VG96912 & JN1003



Crimp contacts

Contact size	Contact type	SOURIAU P/N (no color code)	QPL Part Number	Profile and color code	
#22D	P	8599-0702 JJ	M39029/58-360		Black / Blue / Orange
	S	8599-0706 900	M39029/56-348		Grey / Yellow / Orange
#20	P	8599-0703 SA	M39029/58-363		Orange / Blue / Orange
	S	8599-0707 900	M39029/56-351		Brown / Green / Orange
#16	P	8599-0704 MJ	M39029/58-364		Yellow / Blue / Orange
	S	8599-0708 900	M39029/56-352		Red / Green / Orange
#12	P	8599-0705 MJ	M39029/58-365		Green / Blue / Orange
	S	8599-0709 900	M39029/56-353		Orange / Green / Orange
#8 Power	P	8599-7560	-	-	-
	S	8599-7561	-	-	-
#4 Power	P	8599-7534	-	-	-
	S	8599-7535	-	-	-

8ST Series

VG96912 & JN1003



Coaxial contacts #12

Designation	Part number
Coaxial socket solder #12	THA1-0151A
Coaxial pin solder #12	THA1-0152A
Coaxial pin crimp contact #12	THA1-0155A
Coaxial crimp contact #12	THA1-0156A

Solder cup

Contact size	Contact type	Part number
#22D	Pin	8599-0750 900
#20	Pin	8599-0077A 900
#16	Pin	8599-7482A 900
#12	Socket	8599-7485A 900

For other contacts type please consult us.

Quadrax #8 contacts



Contact type	Version	Souriau Part number	Cross Norm	T°	Impedance	Sealing	Release
Pin	PCB mount	ETH1-1237A	-	125°C	100Ω	Sealed	Rear
		ETH1-1501A	-		150Ω		
	Crimp	ETH1-1345A	EN3155-074	200°C	100Ω		
		ETH1-1503A	-		150Ω		
Socket	PCB mount	ETH1-1238A	-	125°C	100Ω		
		ETH1-1502A	-		150Ω		
	Crimp	ETH1-1346A	EN3155-075	200°C	100Ω		
		ETH1-1504A	-		150Ω		

8ST Series







VG96912 & JN1003

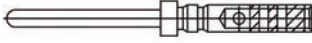

Wire wrap contacts

Contact size	Contact type	Part number	Contact Ø (mm)	Profile	 (mm)
#22D	Pin	8599-0790 JJ	0.76		0.86
#20	Pin	8599-0791 900	1		0.86

Thermocouple contacts

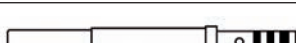
Contact size	Contact type	Souriau part number (without color code)	MIL-DTL-38999 contacts		Ø Contact (mm)	Wire section				Ø Over insulation (mm)	
			Part number	Profile and color code		Awg		mm ²		min	max
						min	max	min	max		
#22D Chromel	Pin	-	M39029/87-472	 Red / Violet / Yellow	0.75	28	22	0.095	0.34	0.76	1.37
	Socket	-	M39029/88-484	 Yellow / Grey / Yellow							
#22D Alumel	Pin	-	M39029/87-471	 Brown / Violet / Yellow							
	Socket	-	M39029/88-483	 Orange / Grey / Yellow							
#20 Chromel	Pin	8599-0749 900	8599-0949 900	 Blue / Violet / Yellow	1	24	20	0.21	0.6	1.02	2.11
	Socket	8599-0753 900	8599-0953 900	 Grey / Grey / Yellow							
#20 Alumel	Pin	8599-0761 900	8599-0961 900	 Green / Violet / Yellow							
	Socket	8599-0765 900	8599-0965 900	 Violet / Grey / Yellow							

8ST Series

VG96912 & JN1003



Dummy contacts

Size	Part number
#16	8599-6A016001A
#8	8599-0308
#4	8599-0310

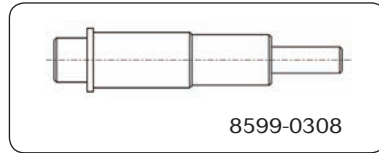

Filler plugs

Contact size	Filler plugs			
	MS Part number (Rev. N)	Souriau Part number	JN1003 (EFA)* Part number	Color
#22D	MS27488-22-2	8660-212	JN1003 N 22	Black
#20	MS27488-20-2	8522-389A	JN1003 N 20	Red
#16	MS27488-16-2	8522-390A	JN1003 N 16	Blue
#12	MS27488-12-2	8522-391A	JN1003 N 12	Yellow

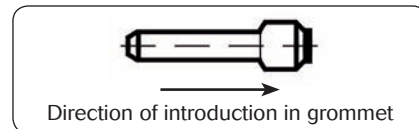

These filler plugs are installed at the rear of unwired contact to maintain connector sealing.

* Please consult us, our product will be evaluated against the final drafts/standards when available.



8ST Series

VG96912 & JN1003

Wiring instruction

Cable preparation and wire stripping

Contact size	#26	#22D	#20	#16	#12	#8	#4
L	4		6			12	

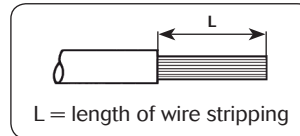

Insertion of wire in contact barrel

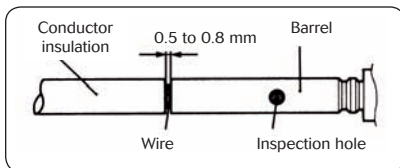

When inserting the stripped wire into the contact barrel check that no strands are left outside and that the wire is visible through the wire inspection hole in the barrel.

Important:

- Slide any accessories over wire strands before carrying out the following operations.
- Contacts are inserted and extracted from the rear of the connector.

Insertion of the contacts

1 - Engage the crimp cable / contact assembly into the longitudinal slot of the plastic tool (coloured tip). Slide the tool down the cable until the tip of the tool abuts the contact retention shoulder.

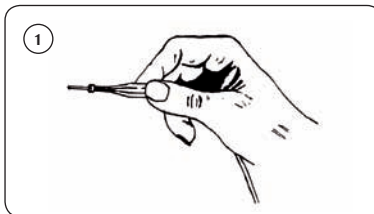

2 - Introduce the contact into the required contact cavity in the insulator, pushing tool axially, until the contact snaps into position in clip.

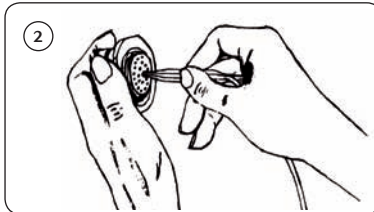

3 - Withdraw the tool (from rear). Check that contact is firmly locked by pulling wire gently. When connector is fully loaded, check the position of contact tips. They should all be in the same plane. Nota: For larger sizes of cable which are stiff enough manual insertion without tool is preferable.

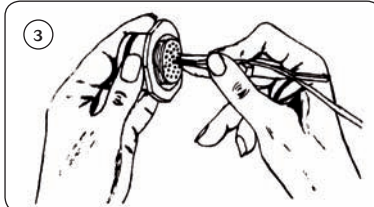

Extraction of the contacts

1 - Engage the appropriate cable into the longitudinal slot of the tool with the white tip towards connector.

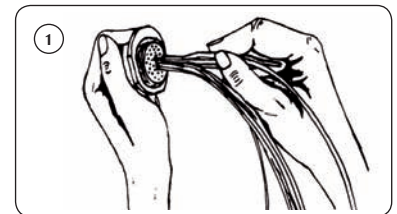

2 - Slide the tool down towards the contact. Insert the tool in the insulator until it abuts the contact shoulder.

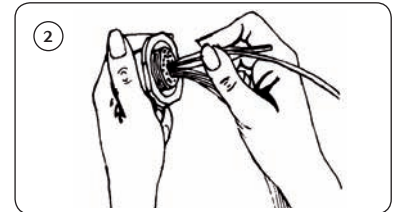

3 - Holding the tool-contact and cable assembly together, remove them simultaneously.

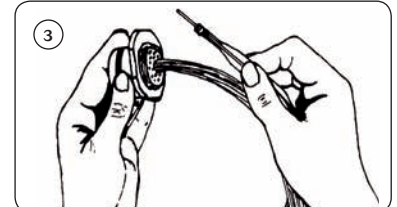

8ST Series

VG96912 & JN1003



Tooling

Crimping tools

Contact size	Contact type	Plier M22520/1-01		Plier M22520/2-01 (Souriau 8476-01)		Plier M300BT	Plier * M22520/23-01	
		Turret Part number Norm	Souriau	Locator Part number Norm	Souriau	Locator Part number	Turret Part number	Locator Part number
#22D	Pin	-	-	M22520/2-09	8476-09	-	-	-
	Socket	-	-	M22520/2-07	8476-07	-	-	-
#20	Pin	M22520/1-04	8365-04	M22520/2-10	8476-10	-	-	-
	Socket					-	-	-
#16	Pin	M22520/1-04	8365-04	-	-	-	-	-
	Socket			-	-	-	-	
#12	Pin	M22520/1-04	8365-04	-	-	-	-	-
	Socket			-	-	-	-	
#8 Power	Pin	-	-	-	-	SP 593	M22520/23-02	8599-9601
	Socket	-	-	-	-			
#4 Power	pin	-	-	-	-	-	M22520/23-04	M22520/23-11
	Socket	-	-	-	-	-		

Contact size	Contact type	Plier M22520/2-01 (Souriau 8476-01)	Plier M22520/31-01	Plier M22520/4-01	Plier M22520/5-01
		Locator Part Number	Locator Part number	Locator Part Number	Die set Part Number
#12 Coaxial M39029/102-558 M39029/103-559	Inner	-	-	-	M22520/5-03
	Outer	-	-	-	
#12 Coaxial M39029/28-211 M39029/75-416	Inner	M22520/2-34	-	-	-
	Outer	-	M22520/31-02	-	-
#16 Coaxial	Inner	M22520/2-35	-	-	-
	Outer	-	-	M22520/4-02	-
#8 Coaxial	Inner	M22520/2-31	-	-	-
	Outer	-	-	-	M22520/5-05 closure B
#8 Triaxial	Inner	K709	-	-	-
	Middle	-	-	-	Y631 closure B
	Ferrule	-	-	-	Y631 closure A

* Pneumatic plier

Note: for the #10 contact's plier and locator, please consult us.

8ST Series

VG96912 & JN1003



Insertion & extraction tools

Contact size	Material	Part number		Color	
		MIL standard	Souriau	Insertion	Extraction
#26	Plastic	-	8599-0399 900	Black	White
#22D	Plastic	M81969/14-01	-	Green	White
#20	Plastic	M81969/14-10	-	Red	Orange
#16	Plastic	M81969/14-03	-	Blue	White
#12	Plastic	M81969/14-04	-	Yellow	White
#10	Plastic	M81969/14-05	-	Grey	-
#8	Plastic	M81969/14-12	-	-	Green
	Metalic	-	8660-197	-	-
#4	Plastic	M81969/14-07	-	-	Blue
	Metalic	-	8533-8175	-	-

Backshell tightening tools

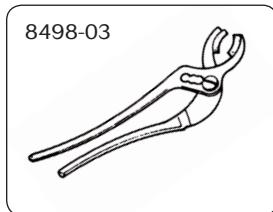

Backshell tightening pliers,
part number: **8498-03**
Square jaws (order 2 jaws),
part number: **8500-1015**

Tightening support

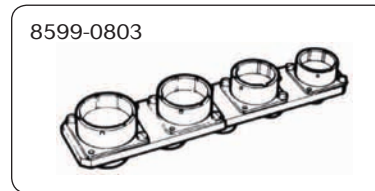

Part number: **8599-0803**
This tool is made up of dummy receptacles housings of all 9 sizes for all key polarisation, and locates free connectors during wiring and fitting of rear accessories.

Tightening of rear accessories:

Shell size	9	11	13	15	17	19	21	23	25
Max torque in m/daN	0.62						1.24		

Slackening tools

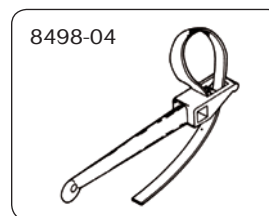

Strap clamp,
part number: **8498-04**
Spare strap,
part number: **8498-103**

Tightening of fixing nuts, receptacle type 7

Shell size	08	10	12	14	16	18	20	22	24
Nut dimension across flats	19.1	22.2	27.0	30.2	33.3	36.5	39.7	42.7	46.0
Max tightening torque on nut (mN)	4	6	9	10	13	20	23	25	26

OST Series



8ST Series

Common Section

■ Backshells	38
■ Protective caps	39
■ Dummy receptacles	40
■ Panel gasket	40
■ Reductors	41
■ Boots	41
■ Orientations	41
■ Coordinates information	42

8ST Series

VG96912 & JN1003



Backshells

Aluminum backshells

Backshell for shielded cables and heatshrink boot

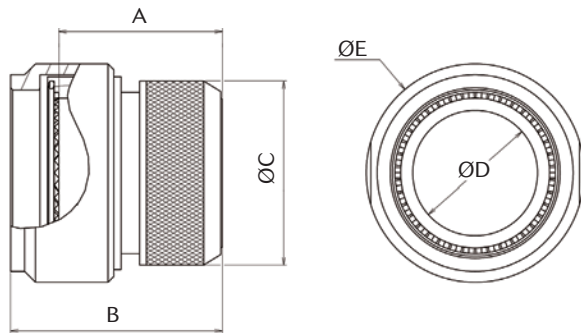

Backshell with cable clamp

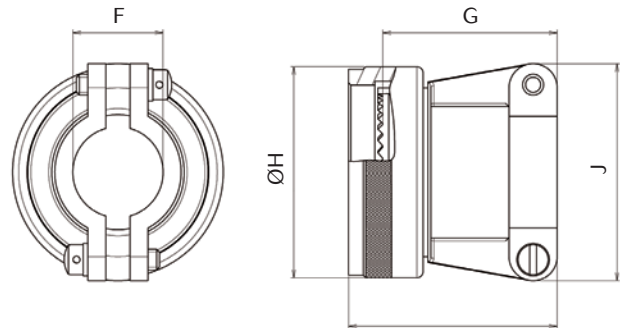

Dimensions

Shell size	A Max	B Max	ØC Max	ØD Max	ØE ±0.2	F Min	F Max	G Max	ØH Max	J Max
08	24.8	34	14	6.4	19	1.58	3.18	14.7	16	20
10	25.8	35	16	7.2	22	1.58	4.78	15.5	19	22
12			18	9.7	25	3.18	6.35	17.1	22	25
14	26.8	36	22	12.7	28	6.35	9.53	23.3	25	28
16			25	15.7	30	6.35	12.70	26.8	29	30
18			28	18.7	34	9.35	15.88		31	36
20			32	21.7	38	12.70	19.05		35	36
22			34	23.7	43	15.88	22.23		38	41
24			38	27.7	45	15.88	25.40		41	43

Ordering information

Basic series **8LST** **101** **G** **52**

Size code:

101, 102, 103, 104, 105, 106, 107, 108, 109

Size code	101	102	103	104	105	106	107	108	109
= Shell size	08	10	12	14	16	18	20	22	24

Plating:

F: Nickel

G: Olive green cadmium

Type:

52: Backshell with cable clamp

57: Backshell for shielded cables and heatshrink boot

8ST Series

VG96912 & JN1003



Protective caps

Metallic protective caps for receptacle

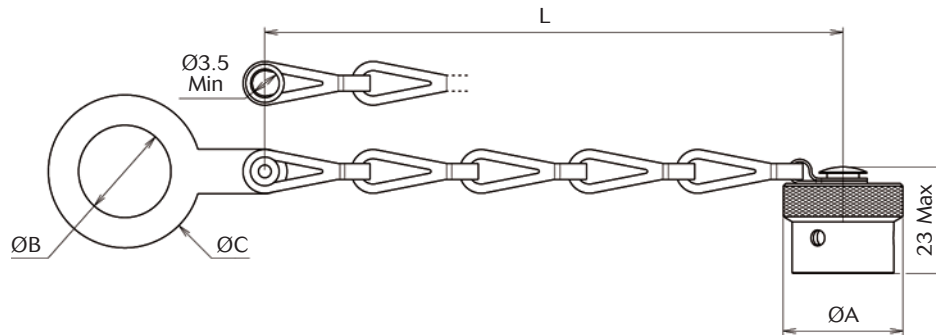

Dimensions

Shell size	ØA Max	ØB Min	ØC Max	L
08	19	14.6	23.5	84
10	22	17.8	26.77	
12	26	22.5	31.55	
14	29	25.7	36.83	100
16	33	28.9	40.31	
18	36	32.1	43.18	
20	39	35.2	46.36	116
22	44	38.4	49.19	
24	46	41.6	52.71	

Ordering information

Basic series 8500- 02 -44D
 8500-: Cap for receptacle

Size code:

02, 03, 04, 05, 27, 06, 07, 08, 09

Size code	02	03	04	05	27	06	07	08	09
= Shell size 8ST	08	10	12	14	16	18	20	22	24

Plating & fixing type:

- J: Olive green cadmium plating with metallic chain and ring
- D: Olive green cadmium plating with metallic chain and eyelet
- 44D: Nickel plating with metallic chain and eyelet

Plastic protective caps

Shell size	ØA		Part numbers	
	Cap for receptacle	Cap for plug	Cap for receptacle	Cap for plug
08	15.40	16.65	8500 5585 A	70 777
10	18.30	19.72	8500 5586 A	70 205
12	22.65	-	8500 5587 A	MS90376 16Y
14	25.80	30.80	8500 5588 A	8500 5600
16	29.20	33.90	8500 5589 A	8500 5601
18	32.40	37.00	8500 5590 A	8500 5602
20	35.60	39.00	8500 5591 A	8500 5592A
22	39.00	42.20	8500 5592 A	8500 5593A
24	42.20	44.50	8500 5593 A	70 472

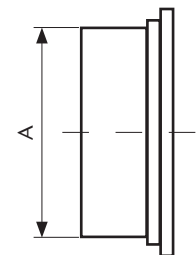

Note: All dimensions are in millimeters (mm)

8ST Series

VG96912 & JN1003



Dummy receptacles

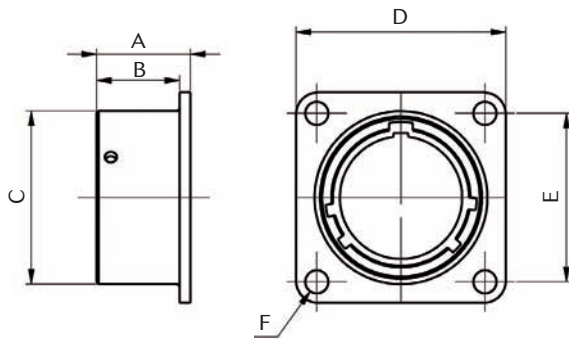

Shell size	Part numbers	A Max	B Max	ØC	D Max	E	ØF ±0.13
08	8ST0-08GUR	18.35	16.05	12.04	21.00	15.10	3.05
10	8ST0-10GUR	18.35	16.05	15.02	24.20	18.26	3.05
12	8ST0-12GUR	18.35	16.05	19.08	26.60	20.62	3.05
14	8ST0614GUR	18.35	16.05	22.26	29.00	23.01	3.05
16	8ST0-16GUR	18.35	16.05	25.43	31.35	24.61	3.05
18	8ST0-18GUR	18.35	16.05	28.61	33.70	26.98	3.05
20	8ST0-20GUR	18.35	15.29	31.78	36.90	29.38	3.05
22	8ST0-22GUR	18.35	15.29	34.96	40.10	31.77	3.05
24	8ST0-24GUR	18.35	15.29	38.13	43.30	34.92	3.73

Panel gasket

Shell size	Part numbers		
	Gasket for receptacle type 0		O ring for receptacle type 7
08	8525-1431	8590-2251	AS3582-017
10	8525-1432	8590-2252	AS3582-019
12	8525-1433	8590-2253	AS3582-022
14	8525-1434	8590-2254	AS3582-024
16	8525-1435	8590-2255	AS3582-026
18	8525-1436	8590-2256	AS3582-028
20	8525-1437	8590-2257	AS3582-128
22	8525-1438	8590-2258	AS3582-130
24	8525-1439	8590-2259	AS3582-132

Notes:

- 8ST0 gasket must be ordered separately
- Compliant to 8ST Series temperature range - max 200°C
- For use up to 125°C, gaskets in accordance with VG95328:
 VG95328T07A...= non conductive
 VG95328 07B...= conductive (for HF application)

8ST Series

VG96912 & JN1003



Reducers

Reductor Size	Part number	For cable	For pin contacts	For socket contacts
#8 Power	8599-7645	#10	8599-7580	8599-7581
#4 Power	8400-2352A	10 mm ²	8599-7534A	8599-7535A

Boots

Boot Size	Part number	Admissible wire section mm ²		For cable
#8 Power	8599-4542	5	6.5	8.48 à 10 mm ²
	8599-4547	2.5	4	#10
#4 Power	8599-4594	6.35	7.5	#4 - #5
	8599-4593	4	5.8	#6 - #8

Orientations

Polarization is determined by the master keyway position. The secondary keyway positions remain fixed.

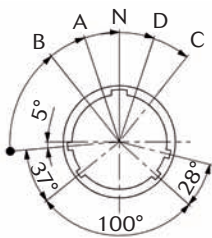

View from front face of receptacle

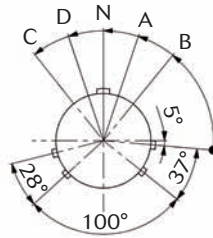

View from front face of plug

Shell size	Angles (degrees)				
	N	A	B	C	D
08	95	77	-	-	113
10	95	81	67	123	109
12	95	75	63	127	115
14	95	74	61	129	116
16	95	77	65	125	113
18	95	77	65	125	113
20	95	77	65	125	113
22	95	80	69	121	110
24	95	80	69	121	110



Coordinates for straight PC tail terminations Viewed from front face of male insulator

Hole sizes: 1mm min. (#22 and #20 contacts) and 1.3mm min. (#16 contact) coordinates in mm.

08

12

Ctc	X	y
1	+0.92	+2.54
2	+2.34	+1.35
3	+2.66	-0.47
4	+1.74	-2.07
5	0.00	-2.70
6	-1.74	-2.07

35

Ctc	X	y
1	+1.14	+1.98
2	+1.98	-1.14
3	0.00	-2.29
4	+1.98	-1.14
5	+1.14	+1.98
6	0.00	0.00

98

Ctc	X	y
A	+1.65	+0.97
B	0.00	-1.90
C	-1.65	+0.97

10

02

Ctc	X	y
A	0.00	+2.41
B	0.00	-2.41

04

Ctc	X	y
A	+1.65	+1.65
B	+1.65	-1.65
C	-1.65	-1.65
D	-1.65	+1.65

05

Ctc	X	y
A	+1.65	+1.42
B	+2.86	-1.65
C	0.00	-3.30
D	-2.86	-1.65
E	-1.65	+1.42

26

Ctc	X	y
1	+1.69	+3.79
2	+3.09	+2.77
3	+3.95	+1.28
4	+4.13	-0.44
5	+3.58	-2.10
6	+2.40	-3.37
7	0.00	-4.13
8	-2.40	-3.37
9	-3.58	-2.10
10	-4.13	-0.44
11	-3.95	+1.28
12	-3.09	+2.77
13	-1.69	+3.79
14	0.00	+3.50
15	+1.70	+1.76
16	+2.55	+0.29
17	+1.70	-1.18
18	+0.85	-2.65
19	-0.85	-2.65
20	-1.70	-1.18
21	-2.55	+0.29
22	-1.70	+1.76
23	0.00	+1.76
24	+0.85	+0.29
25	0.00	-1.18
26	-0.85	+0.29

35

Ctc	X	y
1	0.00	+3.71
2	+2.16	+3.00
3	+3.51	+1.14
4	+3.51	-1.14
5	+2.16	-3.00
6	0.00	-3.71
7	-2.16	-3.00
8	-3.51	-1.14
9	-3.51	+1.14
10	-2.16	+3.00
11	0	+1.42
12	+1.24	-0.89
13	-1.24	-0.89

8ST Series

VG96912 & JN1003



10

98

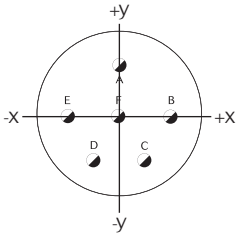

Ctc	X	y
A	0.00	+3.30
B	+3.30	0.00
C	+1.65	-2.87
D	-1.65	-2.87
E	-3.30	0.00
F	0.00	0.00

99

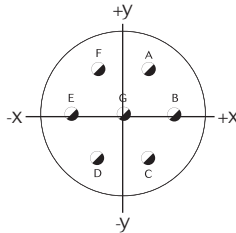

Ctc	X	y
A	+1.65	+2.85
B	+3.30	0.00
C	+1.65	-2.87
D	-1.65	-2.87
E	-3.30	0.00
F	-1.65	+2.87
G	0.00	0.00

12

04

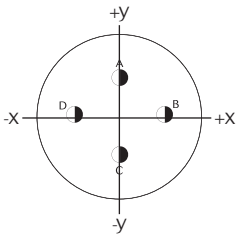

Ctc	X	y
A	0.00	+3.81
B	+3.71	+0.89
C	0.00	-2.11
D	-3.71	+0.89

08

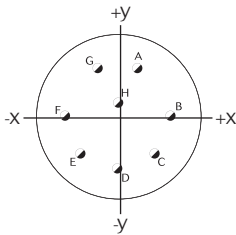

Ctc	X	y
A	+1.65	+3.99
B	+4.32	0.00
C	+3.05	-3.05
D	0.00	-4.32
E	-3.05	-3.05
F	-4.32	0.00
G	-1.65	+3.99
H	0.00	+1.12

35

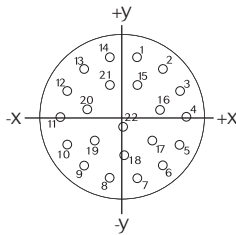

Ctc	X	y
1	+1.14	+5.00
2	+3.20	+4.01
3	+4.62	+2.24
4	+5.16	0.00
5	+4.62	-2.24
6	+3.20	-4.01
7	+1.14	-5.00
8	-1.14	-5.00
9	-3.20	-4.01
10	-4.62	-2.24
11	-5.16	0.00

Ctc	X	y
12	-4.62	+2.24
13	-3.20	+4.01
14	-1.14	+5.00
15	+1.14	+2.72
16	+2.97	+0.66
17	+2.36	-1.91
18	0.00	-3.05
19	-2.36	-1.91
20	-2.97	+0.66
21	-1.14	+2.72
22	0.00	-0.76

43

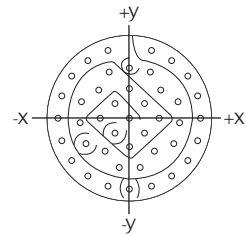

Ctc	X	y
1	+1.80	+5.54
2	-1.80	+5.54
3	+3.42	+4.71
4	+4.71	+3.42
5	+5.54	+1.80
6	+5.82	0.00
7	+5.54	-1.80
8	+4.71	-3.42
9	+3.42	-4.71
10	+1.80	-5.54
11	0.00	-5.82
12	-1.80	-5.54
13	-3.42	-4.71
14	-4.71	-3.42
15	-5.54	-1.80
16	-5.82	0.00
17	-5.54	+1.80
18	-4.71	+3.42
19	-3.42	+4.71
20	0.00	+4.12
21	+1.68	+3.76
22	+2.54	+2.28

Ctc	X	y
23	+3.92	+1.27
24	+4.10	-0.43
25	+3.57	-2.06
26	+1.99	-2.74
27	+0.86	-4.03
28	-0.86	-4.03
29	-1.99	-2.74
30	-3.57	-2.06
31	-4.10	-0.43
32	-3.92	+1.27
33	-2.54	+2.28
34	-1.68	+3.76
35	0.00	+2.42
36	+1.21	+1.21
37	+2.42	0.00
38	+1.21	-1.21
39	0.00	-2.42
40	-1.21	-1.21
41	-2.42	0.00
42	-1.21	+1.21
43	0.00	0.00

98

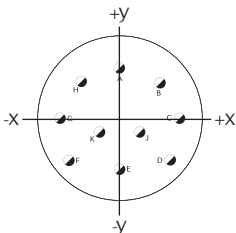

Ctc	X	y
A	0.00	+4.95
B	+3.18	+3.81
C	+4.90	+0.76
D	+4.17	-2.67
E	0.00	-3.43

Ctc	X	y
F	-4.17	-2.67
G	-4.90	+0.76
H	-3.18	+3.81
J	+1.65	-0.38
K	-1.65	-0.38



14

05

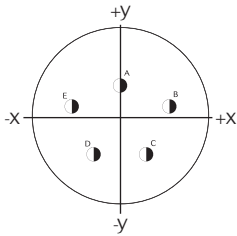

Ctc	X	y
A	0	+2.54
B	+4.42	+0.61
C	+2.39	+3.76
D	-2.39	-3.76
E	-4.42	+0.61

18

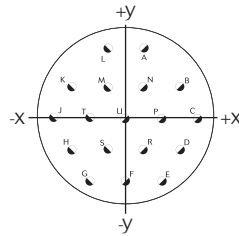

Ctc	X	y	Ctc	X	y
A	+1.65	+6.40	K	-4.95	+2.87
B	+4.95	+2.87	L	-1.65	+6.40
C	+6.60	0.00	M	-1.65	+2.87
D	+4.95	-2.87	N	+1.65	+2.87
E	+3.30	-5.72	P	+3.30	0.00
F	0.00	-5.72	R	+1.65	-2.87
G	-3.30	-5.72	S	-1.65	-2.87
H	-4.95	-2.87	T	-3.30	0.00
J	-6.60	0.00	U	0.00	0.00

19

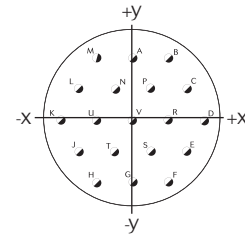

Ctc	X	y	Ctc	X	y
A	0.00	+5.72	L	-4.95	+2.87
B	+3.30	+5.72	M	-3.30	+5.72
C	+4.95	+2.87	N	-1.65	+2.87
D	+6.60	0.00	P	+1.65	+2.87
E	+4.95	-2.87	R	+3.30	0.00
F	+3.30	-5.72	S	+1.65	-2.87
G	0.00	-5.72	T	-1.65	-2.87
H	-3.30	-5.72	U	-3.30	0.00
J	-4.95	-2.87	V	0.00	0.00
K	-6.60	0.00			

97

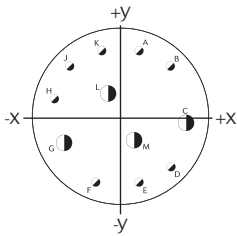

Ctc	X	y
A	+1.65	+5.94
B	+4.52	+4.52
C	+5.84	-0.58
D	+4.52	-4.52
E	+1.65	-5.94
F	-2.26	-5.97
G	-5.26	-2.41
H	-5.94	+1.65
J	-4.52	+4.52
K	-1.65	+5.94
L	-1.19	+2.06
M	+1.19	-2.06

35

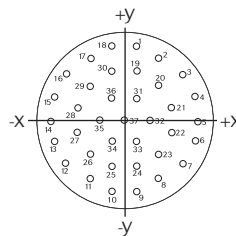

Ctc	X	y	Ctc	X	y
1	+1.14	+6.65	20	+3.12	+3.02
2	+3.12	+5.51	21	+4.32	+1.02
3	+5.36	+4.06	22	+4.32	-1.27
4	+6.45	+2.03	23	+3.12	-3.23
5	+6.75	-0.25	24	+1.14	-4.37
6	+6.27	-2.49	25	-1.14	-4.37
7	+5.08	-4.45	26	-3.12	-3.23
8	+3.30	-5.89	27	-4.32	-1.27
9	+1.14	-6.65	28	-4.32	+1.02
10	-1.14	-6.65	29	-3.12	+3.02
11	-3.30	-5.89	30	-1.14	+4.37
12	-5.08	-4.45	31	+1.14	+1.88
13	-6.27	-2.49	32	+2.29	-0.10
14	-6.76	-0.25	33	+1.14	-2.08
15	-6.45	+2.03	34	-1.14	-2.08
16	-5.36	+4.06	35	-2.29	-0.10
17	-3.12	+5.51	36	-1.14	+1.88
18	-1.14	+6.65	37	0.00	-0.10
19	+1.14	+4.37			

8ST Series

VG96912 & JN1003



16

06

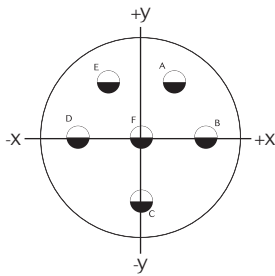

Ctc	X	y
A	+3.07	+5.31
B	+6.12	0.00
C	0.00	-6.12
D	-6.12	0.00
E	-3.07	+5.31
F	0.00	0.00

08

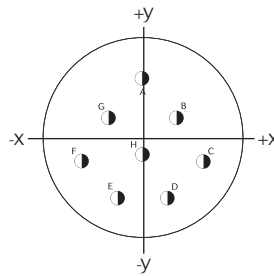

Ctc	X	y
A	0.00	+5.99
B	+3.25	+2.18
C	+5.84	-1.98
D	+2.39	-5.49
E	-2.39	-5.49
F	-5.84	-1.98
G	-3.25	+2.18
H	0.00	-1.32

26

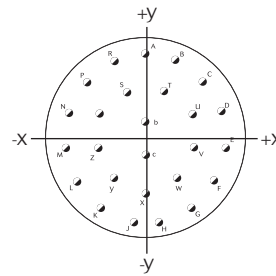

Ctc	X	y
A	0.00	+8.15
B	+3.33	+7.44
C	+6.07	+5.44
D	+7.75	+2.51
E	+8.10	-0.86
F	+7.06	-4.09
G	+4.80	-6.60
H	+1.70	-7.98

Ctc	X	y
J	-1.70	-7.98
K	-4.80	-6.60
L	-7.06	-4.09
M	-8.10	-0.86
N	-7.75	+2.51
P	-6.07	+5.44
R	-3.33	+7.44
S	-1.78	+4.50
T	+1.78	+4.50
U	+4.45	+2.39
V	+4.53	-0.91
W	+3.02	-3.84
X	0.00	-5.16
Y	-3.02	-3.84
Z	-4.53	-0.91
a	-4.45	+2.39
b	0.00	+1.65
c	0.00	-1.65

35

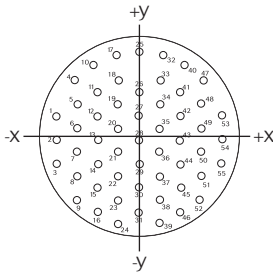

Ctc	X	y
1	-7.92	+2.18
2	-7.92	-0.10
3	-7.92	-2.39
4	-6.15	+5.61
5	-5.94	+3.33
6	-5.94	+1.04
7	-5.94	-1.24
8	-5.94	-3.53
9	-5.94	-5.82
10	-4.37	+7.09
11	-3.96	+4.47
12	-3.96	+2.18

Ctc	X	y
13	-3.96	-0.10
14	-3.96	-2.39
15	-3.96	-4.67
16	-3.96	-6.96
17	-2.26	+8.03
18	-1.98	+5.61
19	-1.98	+3.33
20	-1.98	+1.04
21	-1.98	-1.24
22	-1.98	-3.53
23	-1.98	-5.82
24	-1.98	-8.10

Ctc	X	y
25	0.00	+8.36
26	0.00	+4.47
27	0.00	+2.18
28	0.00	-0.10
29	0.00	-2.39
30	0.00	+4.67
31	0.00	-6.96
32	+2.26	+8.03
33	+1.98	+5.61
34	+1.98	+3.33
35	+1.98	+1.04
36	+1.98	-1.24
37	+1.98	-3.53
38	+1.98	-5.82
39	+1.98	-8.10
40	+4.37	+7.09

Ctc	X	y
41	+3.96	+4.47
42	+3.96	+2.18
43	+3.96	-0.10
44	+3.96	-2.39
45	+3.96	-4.67
46	+3.96	-6.96
47	+6.15	+5.61
48	+5.94	+3.33
49	+5.94	+1.04
50	+5.94	-1.24
51	+5.94	-3.53
52	+5.94	-5.82
53	+7.92	+2.18
54	+7.92	-0.10
55	+7.92	2.39

99

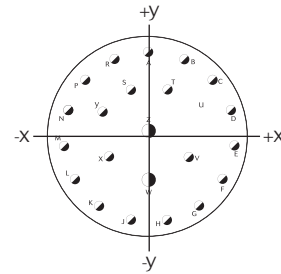

Ctc	X	y
A	0.00	+8.15
B	+3.33	+7.44
C	+6.07	+5.44
D	+7.75	+2.51
E	+8.10	-0.86
F	+7.06	-4.09
G	+4.80	-6.60
H	+1.70	-7.98
J	-1.70	-7.98
K	-4.80	-6.60
L	-7.06	-4.09
M	-8.10	-0.86

Ctc	X	y
N	-7.75	+2.51
P	-6.07	+5.44
R	-3.33	+7.44
S	-1.78	+4.50
T	+1.78	+4.50
U	+4.45	+2.39
V	+3.81	-1.91
W	0.00	-4.09
X	-3.81	-1.91
Y	-4.45	+2.39
Z	0.00	+0.64



18

11

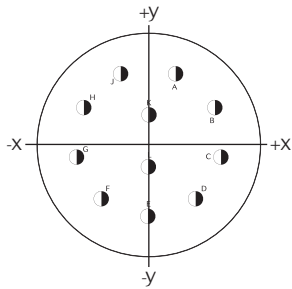

Ctc	X	y
A	+2.67	+6.60
B	+6.35	+3.35
C	+6.99	-1.35
D	+4.55	-5.46
E	0.00	-7.14
F	-4.55	-5.46
G	-6.99	-1.35
H	-6.35	+3.35
J	-2.67	+6.60
K	0.00	+2.67
L	0.00	-2.34

32

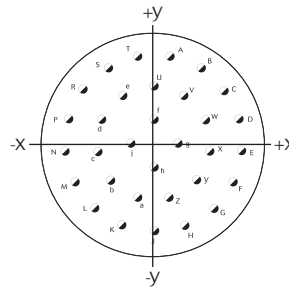

Ctc	X	y
A	+1.68	+8.97
B	+4.80	+7.75
C	+7.26	+5.51
D	+8.76	+2.49
E	+9.07	-0.84
F	+8.15	-4.06
G	+6.15	-6.73
H	+3.30	-8.51
J	0.00	-9.12
K	-3.30	-8.51
L	-6.15	-6.73
M	-8.15	-4.06
N	-9.07	-0.84
P	-8.76	+2.49
R	-7.26	+5.51
S	-4.80	+7.75

Ctc	X	y
T	-1.68	+8.97
U	0.00	+5.84
V	+3.15	+4.90
W	+5.31	+2.41
X	+5.79	-0.84
Y	+4.42	-3.84
Z	+1.65	-5.61
a	-1.65	-5.61
b	-4.42	-3.84
c	-5.79	-0.84
d	-5.31	+2.41
e	-3.15	+4.90
f	0.00	+2.44
g	+2.44	0.00
h	0.00	-2.44
j	-2.44	0.00

35

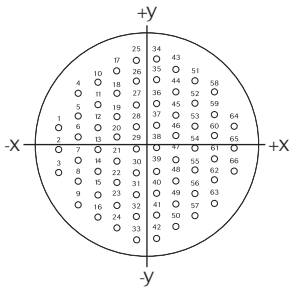

Ctc	X	y
1	-9.07	+2.29
2	-9.07	+0.08
3	-9.07	-2.29
4	-7.09	+5.72
5	-7.09	+3.43
6	-7.09	+1.14
7	-7.09	-1.14
8	-7.09	-3.43
9	-7.09	-5.72
10	-5.11	+6.86
11	-5.11	+4.57
12	-5.11	+2.29
13	-5.11	0.00
14	-5.11	-2.29

Ctc	X	y
15	-5.11	-4.57
16	-5.11	-6.86
17	-3.12	+8.00
18	+3.12	+5.72
19	-3.12	+3.43
20	-3.12	+1.14
21	-3.12	-1.14
22	-3.12	-3.43
23	-3.12	-5.72
24	-3.12	-8.00
25	-1.14	+9.14
26	-1.14	+6.86
27	-1.14	+4.57

Ctc	X	y
28	-1.14	+2.29
29	-1.14	0.00
30	-1.14	-2.29
31	-1.14	-4.57
32	-1.14	-6.86
33	-1.14	-9.14
34	+1.14	+9.14
35	+1.14	+6.86
36	+1.14	+4.57
37	+1.14	+2.29
38	+1.14	0.00
39	+1.14	-2.29
40	+1.14	-4.57

Ctc	X	y
41	+1.14	-6.86
42	+1.14	-9.14
43	+3.12	+8.00
44	+3.12	+5.72
45	+3.12	+3.43
46	+3.12	+1.14
47	+3.12	-1.14
48	+3.12	-3.43
49	+3.12	-5.72
50	+3.12	-8.00
51	+5.11	+6.86
52	+5.11	+4.57
53	+5.11	+2.29

Ctc	X	y
54	+5.11	0.00
55	+5.11	-2.29
56	+5.11	-4.57
57	+5.11	-6.86
58	+7.09	+5.72
59	+7.09	+3.43
60	+7.09	+1.14
61	+7.09	-1.14
62	+7.09	-3.43
63	+7.09	-5.72
64	+9.07	+2.29
65	+9.07	0.00
66	+9.07	-2.29



20

16

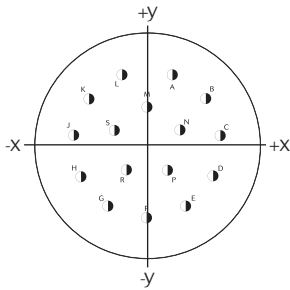

Ctc	X	y	Ctc	X	y
A	+3.00	+8.18	J	-8.66	+0.91
B	+6.88	+5.36	K	-6.88	+5.36
C	+8.66	+0.91	L	-3.00	+8.18
D	+7.82	-3.81	M	0.00	+4.45
E	+4.62	-7.37	N	+3.91	+1.57
F	0.00	-8.71	P	+2.39	-3.10
G	-4.62	-7.37	R	-2.39	-3.10
H	-7.82	-3.81	S	-3.91	+1.57

35

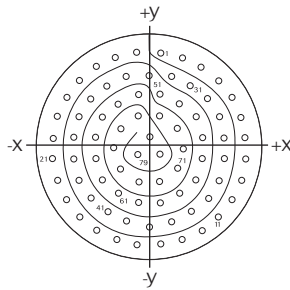

Ctc	X	y
1	+1.35	+10.82
2	+3.71	+10.26
3	+5.89	+9.19
4	+7.77	+7.67
5	+9.27	+5.77
6	+10.31	+3.58
7	+10.85	+1.22
8	+10.85	-1.22
9	+10.31	-3.58
10	+9.27	-5.77
11	+7.77	-7.67
12	+5.89	-9.19
13	+3.71	-10.26

Ctc	X	y
14	+1.35	-10.82
15	-1.35	-10.82
16	-3.71	-10.26
17	-5.89	-9.19
18	-7.77	-7.67
19	-9.27	-5.77
20	-10.31	-3.58
21	-10.85	-1.22
22	-10.85	+1.22
23	-10.31	+3.58
24	-9.27	+5.77
25	-7.77	+7.67
26	-5.89	+9.19
27	-3.71	+10.26
28	-1.35	+10.82
29	0.00	+8.20
30	+2.49	+8.18
31	+4.67	+7.11
32	+6.55	+5.59
33	+7.90	+3.58
34	+8.43	+1.22
35	+8.43	-1.22

Ctc	X	y
36	+7.90	-3.58
37	+6.55	-5.59
38	+4.67	-7.11
39	+2.49	-8.18
40	0.00	-8.81
41	-2.49	-8.18
42	-4.67	-7.11
43	-6.55	-5.59
44	-7.90	-3.58
45	-8.43	-1.22
46	-8.43	+1.22
47	-7.90	+3.58
48	-6.55	+5.59
49	-4.67	+7.11
50	-2.49	+8.18
51	-1.22	+6.12
52	+1.22	+6.12
53	+3.40	+5.05
54	+5.28	+3.53
55	+6.02	+1.22
56	+6.02	-1.22
57	+5.28	-3.53

Ctc	X	y
58	+3.40	-5.05
59	+1.22	-6.12
60	-1.22	-6.12
61	-3.40	-5.05
62	-5.28	-3.53
63	-6.02	-1.22
64	-6.02	+1.22
65	-5.28	+3.53
66	-3.40	+5.05
67	-1.22	+3.71
68	+1.22	+3.71
69	+3.18	+2.29
70	+3.94	0.00
71	+3.18	-2.29
72	+1.22	-3.71
73	-1.22	-3.71
74	-3.18	-2.29
75	-3.94	0.00
76	-3.18	+2.29
77	0.00	+1.35
78	+1.22	-0.74
79	-1.22	-0.74

39

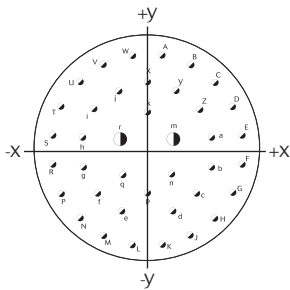

Ctc	X	y	Ctc	X	y	Ctc	X	y
A	+1.65	+10.44	P	-9.42	-4.80	d	+2.84	-6.73
B	+4.80	+9.42	R	-10.44	-1.65	e	-2.84	-6.73
C	+7.47	+7.47	S	-10.44	+1.65	f	-5.51	-4.80
D	+9.42	+4.80	T	-9.42	+4.80	g	-7.11	-1.88
E	+10.44	+1.65	U	-7.47	+7.47	h	-7.11	+1.45
F	+10.44	-1.65	V	-4.80	+9.42	i	-5.89	+4.55
G	+9.42	-4.80	W	-1.65	+10.44	j	-3.20	+6.50
H	+7.47	-7.47	X	0.00	+7.49	k	0.00	+4.17
J	+4.80	-9.42	Y	+3.20	+6.50	m	+2.90	+1.22
K	+1.65	-10.44	Z	+5.89	+4.55	n	+2.69	-2.72
L	-1.65	-10.44	a	+7.11	+1.45	p	0.00	-4.80
M	-4.80	-9.42	b	+7.11	-1.88	q	-2.69	-2.72
N	-7.47	-7.47	c	+5.51	-4.80	r	-2.90	+1.22

41

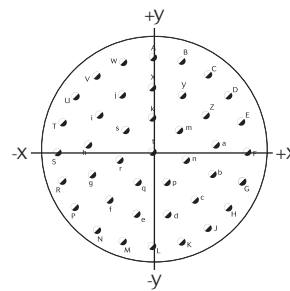

Ctc	X	y
A	0.00	+10.60
B	+3.28	+10.09
C	+6.23	+8.58
D	+8.58	+6.23
E	+10.09	+3.28
F	+10.60	0.00
G	+10.09	-3.28
H	+8.58	-6.23
J	+6.23	-8.58
K	+3.28	-10.09
L	0.00	-10.60

Ctc	X	y
M	-3.26	-10.09
N	-6.23	-8.58
P	-8.58	-6.23
R	-10.09	-3.28
S	-10.60	0.00
T	-10.09	+3.28
U	-8.58	+6.23
V	-6.23	+8.58
W	-3.28	+10.09
X	0.00	+7.20
Y	+3.35	+6.38

Ctc	X	y
Z	+5.92	+4.09
a	+7.15	+0.87
b	+6.73	-2.55
c	+4.78	-5.39
d	+1.73	-6.99
e	-1.73	-6.99
f	-4.78	-5.39
g	-6.73	-2.55
h	-7.15	+0.87
i	-5.92	+4.09
j	-3.35	+6.38
k	0.00	+3.81
m	+2.98	+2.38
n	+3.71	-0.85
p	-1.66	-3.43
q	+1.66	-3.43
r	-3.71	-0.85
s	-2.98	+2.38
t	0.00	0.00

8ST Series

VG96912 & JN1003



22

21

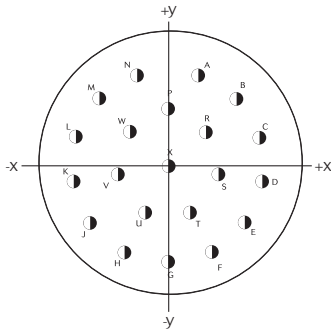

Ctc	X	y
A	+3.25	+9.78
B	+7.34	+7.24
C	+9.80	+3.12
D	+10.16	-1.65
E	+8.33	-6.07
F	+4.65	-9.19
G	0.00	-10.31
H	-4.65	-9.19
J	-8.33	-6.07
K	-10.16	-1.65
L	-9.80	+3.12
M	-7.34	+7.24
N	-3.25	+9.78
P	0.00	+6.22
R	+4.06	+3.71
S	+5.44	-0.89
T	+2.39	-4.93
U	-2.39	-4.93
V	-5.44	-0.89
W	-4.06	+3.71
X	0.00	0.00

53

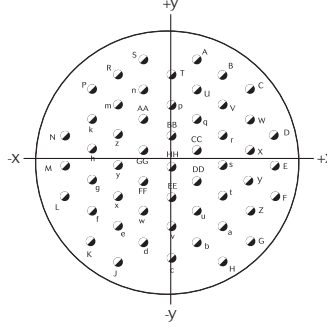

Ctc	X	y
N	-11.43	+3.30
P	-8.53	+8.26
R	-5.72	+9.91
S	-2.84	+11.56
T	0.00	+9.91
U	+2.84	+8.26
V	+5.72	+6.60
W	+8.53	+4.95
X	+8.53	+1.65
Y	+8.53	-1.65
Z	+8.53	-4.95
a	+5.72	-6.60
b	+2.84	-8.26
c	0.00	-9.91
d	-2.84	-8.26
e	-5.72	-6.60
f	-8.53	-4.95
g	-8.53	-1.65
h	-8.53	+1.65
k	-8.53	+4.95
m	-5.72	+6.60
n	-2.84	+8.26
p	0.00	+6.60
q	+2.84	+4.95
r	+5.72	+3.30
s	+5.72	0.00
t	+5.72	-3.30
u	+2.84	-4.95
v	0.00	-6.60
w	-2.84	-4.95
x	-5.72	-3.30
y	-5.72	0.00
z	-5.72	+3.30
AA	-2.84	+4.95
BB	0.00	+3.30
CC	+2.84	+1.65
DD	+2.84	-1.65
EE	0.00	-3.30
FF	-2.84	-1.65
GG	-2.84	+1.65
HH	0.00	0.00

Ctc	X	y
A	+2.84	+11.56
B	+5.72	+9.91
C	+8.53	+8.26
D	+11.43	+3.30
E	+11.43	0.00
F	+11.43	-3.30

Ctc	X	y
G	+8.53	-8.26
H	+5.72	-10.41
J	-5.72	-10.41
K	-8.53	-8.26
L	-11.43	-3.30
M	-11.43	0.00

24

04

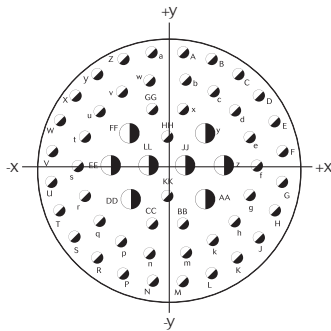

Ctc	X	y
R	-8.23	-10.80
S	-10.77	-8.28
T	-12.52	-5.21
U	-13.49	-1.75
V	-13.49	+1.75
W	-12.52	+5.21
X	-10.77	+8.28
Y	-8.23	+10.80
Z	-5.16	+12.57
a	-1.75	+13.49
b	+2.18	+10.08
c	+5.38	+8.78
d	+7.90	+6.38
e	+9.58	+3.35
f	+10.46	0.00
g	+9.58	-3.35
h	+7.90	-6.38
k	+5.38	-8.78
m	+2.18	-10.08
n	-2.18	-10.08
p	-5.38	-8.78

Ctc	X	y
q	-7.90	-6.38
r	-9.58	-3.35
s	-10.46	0.00
t	-9.58	+3.35
u	-7.90	+6.38
v	-5.38	+8.78
w	-2.18	+10.08
x	+1.75	+6.66
y	+4.37	+3.78
z	+6.55	0.00
AA	+4.37	-3.78
BB	+1.75	-6.66
CC	-1.75	-6.66
DD	-4.37	-3.78
EE	-6.55	0.00
FF	-4.37	-3.78
GG	-1.75	-6.66
HH	0.00	+3.35
JJ	+2.18	0.00
KK	0.00	-3.35
LL	-2.18	0.00

29

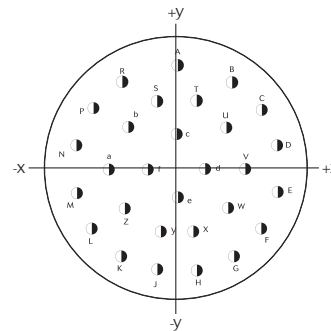

Ctc	X	y
A	0.00	+12.22
B	+6.55	+10.31
C	+10.03	+7.04
D	+11.91	+2.77
E	+11.91	-2.77
F	+10.03	-7.04
G	+6.68	-10.31
H	+2.31	-11.99

Ctc	X	y
J	-2.31	-11.99
K	-6.68	-10.31
L	-10.03	-7.04
M	-11.91	-2.77
N	-11.91	+2.77
P	-10.03	+7.04
R	-6.55	+10.31
S	-2.31	+8.15
T	+2.31	+8.15
U	+5.79	+4.93
V	+8.10	0.00
W	+6.10	-4.60
X	+2.31	-7.37
Y	-2.31	-7.37
Z	-6.10	-4.60
a	-8.10	0.00
b	-5.79	+4.93
c	0.00	+4.09
d	+3.40	0.00
e	0.00	-3.30
f	-3.40	0.00

Ctc	X	y
A	+1.75	+13.49
B	+5.16	+12.57
C	+8.23	+10.80
D	+10.77	+8.28
E	+12.52	+5.21
F	+13.49	+1.75
G	+13.49	-1.75

Ctc	X	y
H	+12.52	-5.21
J	+10.77	-8.28
K	+8.23	-10.80
L	+5.16	-12.57
M	+1.75	-13.49
N	-1.75	-13.49
P	-5.16	-12.57

8ST Series

VG96912 & JN1003



24

35

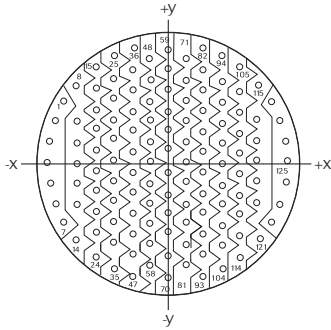

Ctc	X	y	Ctc	X	y	Ctc	X	y	Ctc	X	y	Ctc	X	y
1	-12.17	+7.09	27	-6.32	+7.24	53	-2.11	0.00	79	+2.11	-7.24	104	+6.32	-12.07
2	-13.21	+4.83	28	-6.32	+4.83	54	-2.11	-2.41	80	+2.11	-9.65	105	+8.43	+11.28
3	-13.87	+2.41	29	-6.32	+2.41	55	-2.11	-4.83	81	+2.11	-12.07	106	+8.43	+8.43
4	-14.10	0.00	30	-6.32	0.00	56	-2.11	-7.24	82	+4.06	+13.49	107	+8.43	+6.02
5	-13.87	-2.41	31	-6.32	-2.41	57	-2.11	-9.65	83	+4.22	+10.85	108	+8.43	+3.61
6	-13.21	-4.83	32	-6.32	-4.83	58	-2.11	-12.07	84	+4.22	+8.43	109	+8.43	+1.19
7	-12.17	-7.09	33	-6.32	-7.24	59	0.00	+13.26	85	+4.22	+6.02	110	+8.43	-1.19
8	-10.77	+9.07	34	-6.32	-9.65	60	0.00	+10.85	86	+4.22	+3.61	111	+8.43	-3.61
9	-10.54	+4.83	35	-6.32	-12.07	61	0.00	+8.43	87	+4.22	+1.19	112	+8.43	-6.02
10	-10.54	+2.41	36	-4.06	+13.49	62	0.00	+6.02	88	+4.22	-1.19	113	+8.43	-8.43
11	-10.54	0.00	37	-4.22	+10.85	63	0.00	+3.61	89	+4.22	-3.61	114	+8.43	-10.85
12	-10.54	-2.41	38	-4.22	+8.43	64	0.00	+1.19	90	+4.22	-6.02	115	+10.77	+9.07
13	-10.54	-4.83	39	-4.22	+6.02	65	0.00	-1.19	91	+4.22	-8.43	116	+10.54	+4.83
14	-10.77	-9.07	40	-4.22	+3.61	66	0.00	-3.61	92	+4.22	-10.85	117	+10.54	+2.41
15	-8.43	+11.28	41	-4.22	+1.19	67	0.00	-6.02	93	+4.22	-13.26	118	+10.54	0.00
16	-8.43	+8.43	42	-4.22	-1.19	68	0.00	-8.43	94	+6.32	+12.60	119	+10.54	-2.41
17	-8.43	+6.02	43	-4.22	-3.61	69	0.00	-10.85	95	+6.32	+9.65	120	+10.54	-4.83
18	-8.43	+3.61	44	-4.22	-6.02	70	0.00	-14.10	96	+6.32	+7.24	121	+10.77	-9.07
19	-8.43	+1.19	45	-4.22	-8.43	71	+2.11	+12.07	97	+6.32	+4.83	122	+12.17	+7.09
20	-8.43	-1.19	46	-4.22	-10.85	72	+2.11	+9.65	98	+6.32	+2.41	123	+13.21	+4.83
21	-8.43	-3.61	47	-4.22	-13.26	73	+2.11	+7.34	99	+6.32	0.00	124	+13.87	+2.41
22	-8.43	-6.02	48	-2.11	+12.07	74	+2.11	+4.83	100	+6.32	-2.41	125	+14.10	0.00
23	-8.43	-8.43	49	-2.11	+9.65	75	+2.11	+2.41	101	+6.32	-4.83	126	+13.87	-2.41
24	-8.43	-10.85	50	-2.11	+7.24	76	+2.11	0.00	102	+6.32	-7.24	127	+13.21	-4.83
25	-6.32	+12.60	51	-2.11	+4.83	77	+2.11	-2.41	103	+6.32	-9.65	128	+12.17	-7.09
26	-6.32	+9.65	52	-2.11	+2.41	78	+2.11	-4.83						

43

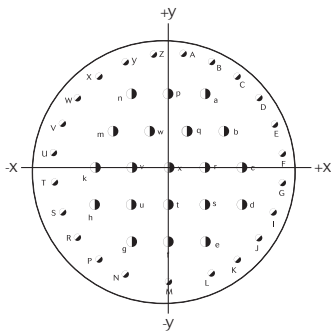

Ctc	X	y	Ctc	X	y
A	+1.75	+13.49	Z	-1.75	+13.4
B	+5.16	+12.57	a	+4.37	+8.74
C	+8.23	+10.80	b	+6.55	+4.37
D	+10.77	+8.28	c	+8.74	0.00
E	+12.52	+5.21	d	+8.74	-4.37
F	+13.49	+1.75	e	+4.37	-8.74
G	+13.49	-1.75	f	0.00	-8.74
H	+12.52	-5.21	g	-4.37	-8.74
J	+10.77	-8.28	h	-8.74	-4.37
K	+8.23	-10.80	k	-8.74	0.00
L	+5.16	-12.57	m	-6.55	+4.37
M	0.00	-13.49	n	-4.37	+8.74
N	-5.16	-12.57	p	0.00	+8.74
P	-8.23	-10.80	q	+2.18	+4.37
R	-10.77	-8.28	r	+4.37	0.00
S	-12.52	-5.21	s	+4.37	-4.37
T	-13.49	-1.75	t	0.00	-4.37
U	-13.49	+1.75	u	-4.37	-4.37
V	-12.52	+5.21	v	-4.37	0.00
W	-10.77	+8.28	w	-2.18	+4.37
X	-8.23	+10.80	x	0.00	0.00
Y	-5.16	+12.57			

61

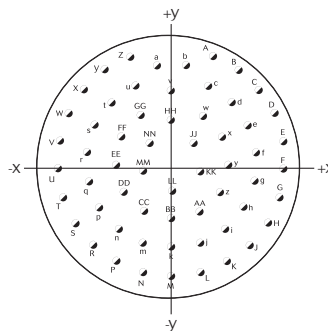

Ctc	X	y	Ctc	X	y	Ctc	X	y	Ctc	X	y
A	+4.98	+12.70	K	+6.58	-11.94	V	-13.39	+2.57	t	-7.24	+7.19
B	+7.98	+11.05	L	+3.40	-13.18	W	-12.32	+5.84	u	-4.39	+9.22
C	+10.49	+8.71	M	0.00	-13.64	X	-10.49	+8.71	v	0.00	+8.59
D	+12.32	+5.84	N	-3.40	-13.18	Y	-7.98	-11.05	w	+3.73	+5.66
E	+13.39	+2.57	P	-6.58	-11.94	Z	-4.98	+12.10	x	+6.02	+3.10
F	+13.61	-0.76	R	-9.35	-9.93	a	-1.73	+11.53	y	+6.78	-0.25
G	+12.98	-4.17	S	-11.53	-7.29	b	+1.73	+11.53	z	+5.79	-3.53
H	+11.53	-7.29	T	-12.98	-4.17	c	+4.39	+9.22	AA	+3.33	-5.92
J	+9.35	-9.93	U	-13.61	-0.76	d	+7.24	+7.19	BB	0.00	-6.78
						e	+9.19	+4.45	CC	-3.33	-5.92
						f	+10.13	+1.17	DD	-5.79	-3.53
						g	+9.96	-2.24	EE	-6.78	-0.25
						h	+8.66	-5.41	FF	-6.02	+3.10
						i	+6.38	-7.98	GG	-3.73	+5.66
						j	+3.38	-9.63	HH	0.00	+5.08
						k	0.00	-10.21	JJ	+2.67	+2.39
						m	-3.38	-9.63	KK	+3.43	-1.04
						n	-6.38	-7.98	LL	0.00	-3.35
						p	-8.66	-5.41	MM	-3.43	-1.04
						q	-9.96	-2.24	NN	-2.67	+2.39
						r	-10.13	+1.17	PP	0.00	0.00
						s	-9.19	+4.45			

OST Series



8ST Series

Range Extension

■ 8STA Series & 8STA derived Series	52
■ 847/848 Series	53
■ VGE1 Series	53
■ micro38999 Series	54
■ 851 Series	54





Range Extension

Product range extension

8STA Series

8STA Series circular connectors are derived from international military specifications MIL-DTL-38999 and JN1003. Dedicated to Motorsport markets, 8STA Series connectors are designed to withstand high levels of shock and vibration in harsh environments.

The world smallest and most popular connector:

- . 8STA Series Size 02.
- . Miniature lightweight connector.
- . Ideal for areas where space is a premium.

Versatility:

- . Removable crimp contacts.
- . Available with PCB contacts.

User friendly:

- . Quick bayonet locking.
- . Integrated backshell
- . Visual color indication when mated.
- . Up to 7 color coded keyway orientations.



See «Compact Circular Connectors 8STA/8TA Series» catalog on www.souriau.com

8STA Derived Series

One of the primary objectives with 8STA Series family is to push the boundaries of innovation ! Continuing on with this theme, many new 8STA products are developed by SOURIAU teams.

Blind mating plug:

- . Quick connection in hard-to-reach areas.
- . Compensating misalignment in 3 axes.

Steering boss system:

- . Quick release.

Hermetic & fuel tank version:

- . Excellent hermeticity and corrosion resistance.
- . Resistance to racing fuels and fluids.

Integrated clinch nuts:

- . Elimination of nut plates - convenient, weight and time saving.

High density layouts and power contacts available.



See «Compact Circular Connectors 8STA/8TA Series» catalog on www.souriau.com



Range Extension

Product range extension

847/848 Series

Especially designed for light and harsh environment. Its physical characteristics and performances are appreciated in a large range of applications: military ground equipment, heavy weapons, ...

Environment friendly:

- . RoHS black zinc nickel: 848 Series.
- . 500 hours salt spray.

Safety:

- . DIN EN 60664-1 (VDE 0110-1) approved.

Reliable:

- . Robust circular aluminum connector.
- . Power supply up to 63A (DC to 3 phase AC)
- . Large variety of backshells and wide range of wire gauges and current carrying capabilities.

Standards:

- . VG96918 approved and qualified.



VGE1 Series

The solution for outdoor/indoor data transmission in harsh environments. Ruggedised bayonet connection. Signal and Quadrax layouts. Tested following NF F 61-030

Quick coupling:

- . Bayonet coupling.

Suitable for indoor applications:

- . Flame retardant material.

High corrosion resistance:

- . 500 hours salt spray resistant.

4 layouts with standard # 16 contacts:

- . 10, 19, 37, 60 contacts.





Range Extension

Product range extension

micr 38999

A complete miniature range: threaded (8DA), break away (8BA) & bayonet (8LTA). Space saving with scoop proof connector for harsh applications.

A compact solution:

- . Diameter up to 45% smaller than size 9 (D38999).
- . Up to 50% shorter.
- . Integrated backshell: Cost and space saving.

A high density solution:

- . With #26 contacts (according to 39029).
- . 5 layouts (size 3, 5 and 7 with #22 & #26).

Excellent features:

- . Designed for D38999 requirements.
- . IP67 sealing when mated.
- . Stainless steel shell (1500 matings) & aluminum shell (500 matings).

RoHS and Cadmium free:

- . Available in zinc nickel (RoHS) plating, as well as nickel and olive drab cadmium.



851 Series

Designed to ensure reliable and rapid electrical connections thanks to a bayonet locking system. General characteristics and lightweight compact size contribute to successful adoption in numerous applications.

High corrosion resistance:

- . 500 hours salt spray.

Quick coupling:

- . Bayonet coupling (1/3 turn).

Polarization:

- . Five keys.

EMC requirements:

- . Shielded plug available.

Endurance:

- . 500 mating cycles.



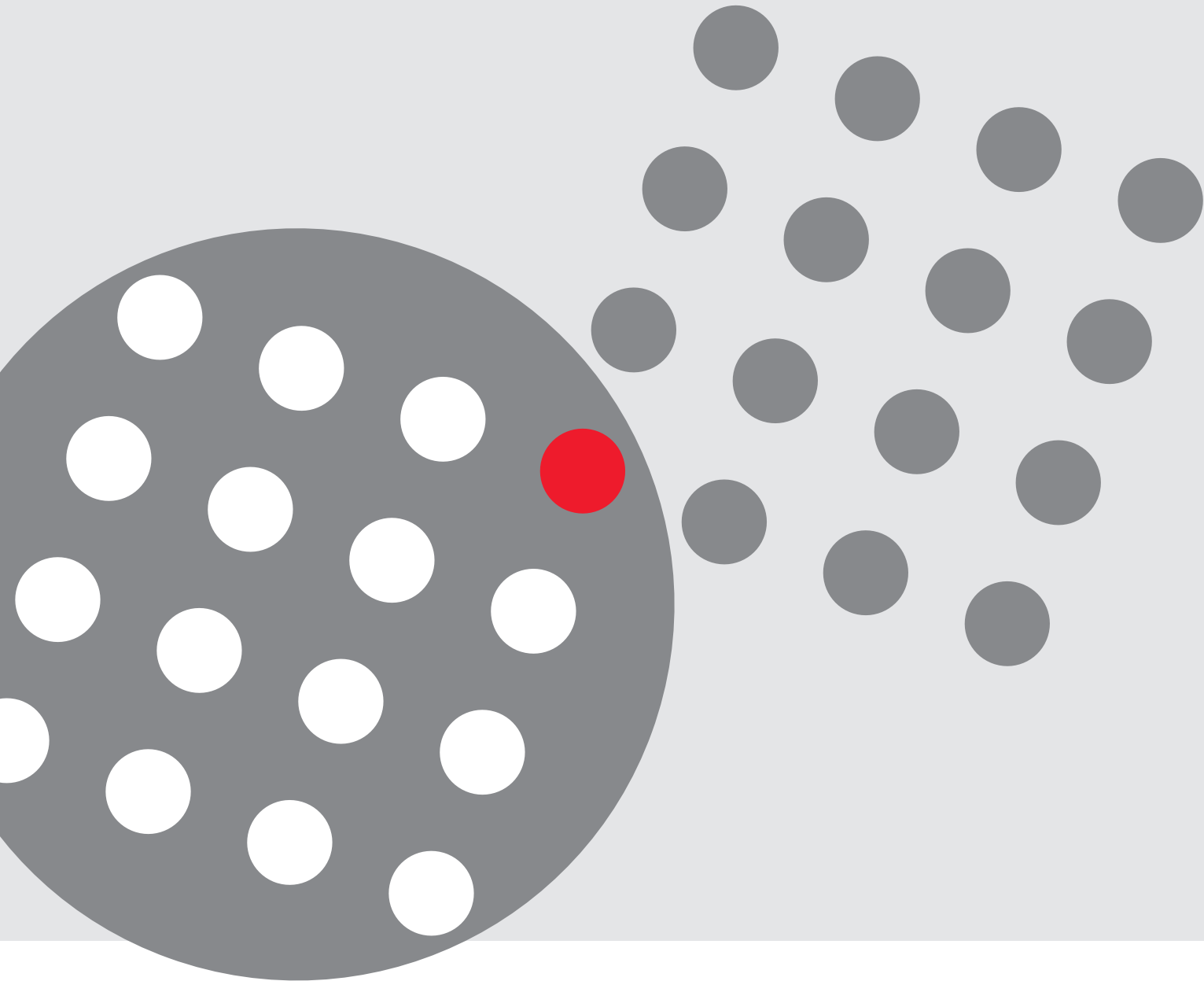

SOURIAU

www.souriau.com

contactmilaero@souriau.com

Esterline
Connection Technologies

X-ON Electronics

Largest Supplier of Electrical and Electronic Components

Click to view similar products for [Circular MIL Spec Connector](#) category:

Click to view products by [Sunbank](#) manufacturer:

Other Similar products are found below :

[0025-262-542](#) [0025-264-3014](#) [58-570121-04S](#) [0134-202-1200](#) [0134-207-1206](#) [0134-207-1800](#) [0134-207-2207](#) [0134-213-0806](#) [0134-213-1007](#) [0134-213-1009](#) [0134-213-1208](#) [0134-213-1800](#) [0134-213-2209](#) [0025-258-000](#) [015-9516-002](#) [60-042722-19P](#) [0114-201-1278](#) [602GB06EG24-61SN](#) [0134-201-1207](#) [0134-201-1806](#) [0134-201-2006](#) [0134-201-2007](#) [0134-201-2010](#) [0134-202-1400](#) [0134-207-0809](#) [0134-207-1208](#) [0134-207-2009](#) [0134-213-1006](#) [6104-207-2302](#) [6104-208-1902](#) [6104-215-0902](#) [6131-202-19149P](#) [6131-204-21149P](#) [6131-207-13149P](#) [6131-208-13149P](#) [6131-209-17149P](#) [6131-210-11149P](#) [6131-211-19149P](#) [6131-216-19149P](#) [6131-220-25149P](#) [6131-259-11149P](#) [6131-259-21149P](#) [6131-259-23149P](#) [6131-263-19149P](#) [6131-265-17149P](#) [6131-265-19149P](#) [CS3102A-20-15P](#) [CS3102C18-4P-472](#) [CS3106A-10SL-53S](#) [CS3106A-10SL-64S](#)