

8D SERIES



# SOURIAU

Standard Aerospace & Military Connectors

MIL-DTL-38999 Series III/EN3645



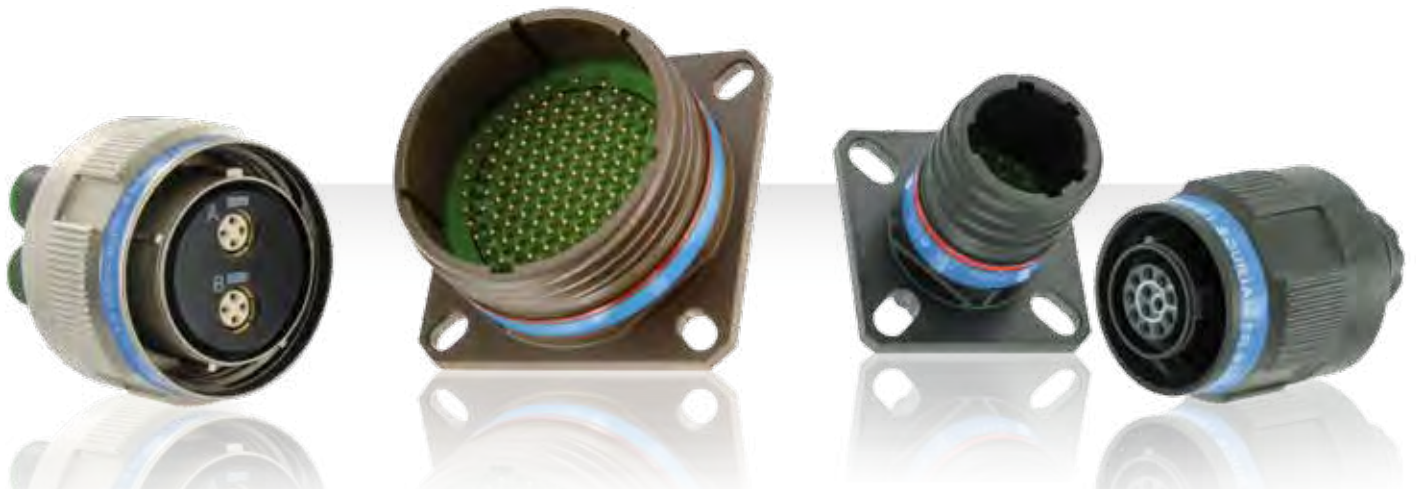

## Presentation

Since the early 80's, **SOURIAU** is a major supplier of 38999 Series III, the screw-coupled version of MIL-C-38999. Present on the main international programs, **SOURIAU** has developed a range of products that meet the performance required in extreme environments. This product family is in accordance with MIL-DTL-38999 Series III, EN3645, CECC (standard for bronze shell), and also meets many customers' standards (Rolls Royce, ABS, BACC, ...)

This evolution of MIL-C-38999 allows:

- ▶ A high contact density up to 128 contacts #22D
- ▶ A quick screw coupling with self locking mechanism
- ▶ High resistance to harsh environments (vibration, 200°C)

Always at the cutting edge of innovation, **SOURIAU's** teams have continuously improved this range of connectors:

- ▶ Composite version in the 90's (Its choice is recommended wherever weight is critical)
- ▶ Titanium version for weight saving and very high and mechanical resistance
- ▶ Today **SOURIAU** remains innovative with cadmium free and RoHS solutions.

In 2009 **SOURIAU** was the first to be QPL qualified for Zinc Nickel plating.

## Contents

### Overview

Typical applications .....	6
Features & Benefits .....	7
Product overview .....	8
A universal product platform .....	10
Technical characteristics .....	11
Contact layouts .....	13

### Standard Series

Aluminum Series .....	22
Composite Series .....	35
Stainless steel Series .....	41
Titanium Series .....	47
Bronze Series .....	52

### Common Section

Contacts .....	64
Dummy contacts / Filler plugs .....	70
Wiring instruction .....	71
Tooling .....	72
Accessories .....	74
Orientations .....	75
Panel cut-out .....	75
Coordinates .....	76

### Derived Series

.....	85
-------	----

### Range Extension

.....	141
-------	-----

# 8D SERIES

## 8D Series

# Overview

■ Typical applications .....	6
■ Features & Benefits .....	7
■ Product overview - A superior concept .....	8
■ Product overview - A performing MIL standard connector design .....	10
■ A universal product platform .....	10
■ Technical characteristics .....	11
■ Contact layouts .....	13
■ Contact layouts (matrix) .....	18

## Typical applications



Civil Aeronautics



Military Aeronautics



Defense



Ground Military



Industrial



Marine - Offshore

## Features & Benefits

**QPL**

### **MIL-DTL-38999 Qualified**

54 qualified layouts.  
Qualified protective caps.

---

**ROBUST**

### **High reliability**

Temperature up to 200°C.  
High vibration withstanding (44g).  
500 mating/unmating cycles.

---

**LIGHT  
WEIGHT**

### **High end materials**

Aluminum (D38999 & EN3645 qualified).  
Composite (D38999, EN3645 & BACC qualified).  
Titanium version.

---

**LARGE  
OFFER**

### **Versatility**

RoHS platings, high density layouts, ...  
Contacts: signal, high speed (optical, quadrax), high power, ...  
Specific shells: double flange, clinch nuts, integrated backshell, ...

---

**FIRE  
SEAL**

### **Class K**

Stainless steel (D38999, EN3645 & BACC qualified).  
Hermetic version.

---

### Standard Series

- ▶ 5 different materials
- ▶ A full platform that matches any environment
- ▶ Different platings (including RoHS & Cadmium free platings)

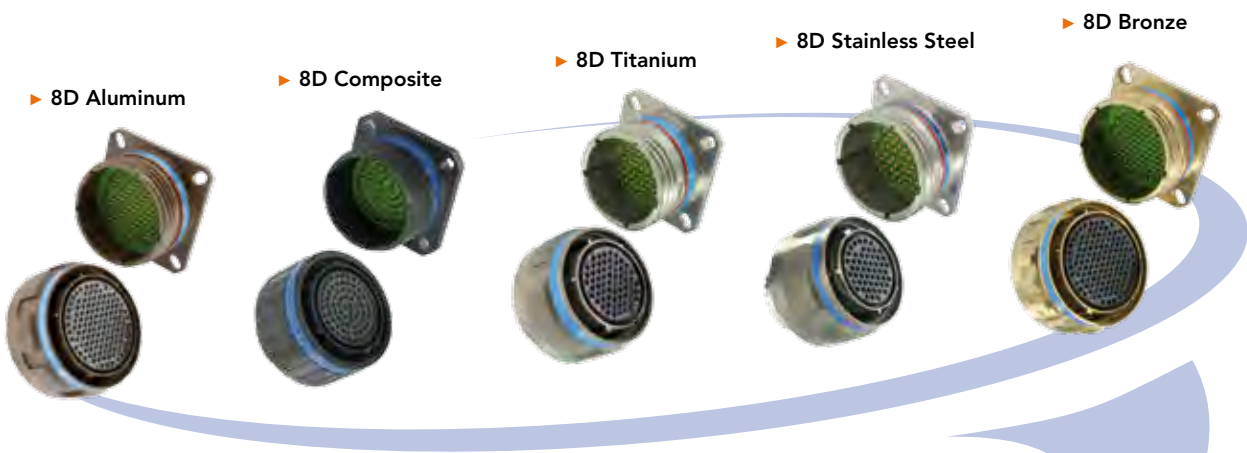

### Derived Series

- ▶ Various possibilities of range extension & shell variant from Standard Series
- ▶ The only limit is your imagination: Consult us !

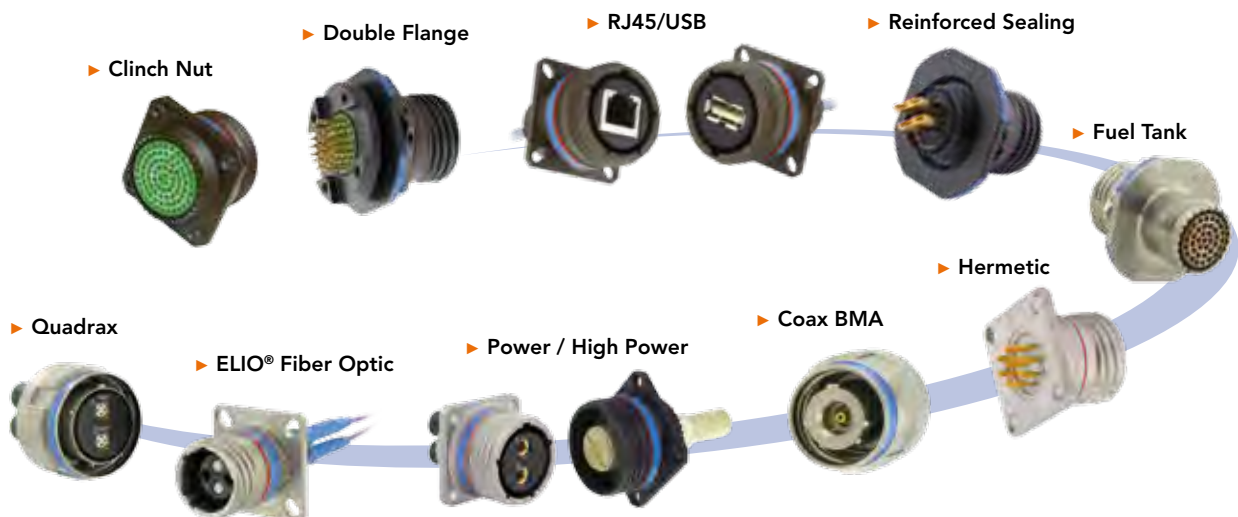



## A superior concept

### A full range of contacts

▶ Multi-contact technology provides versatile connectors

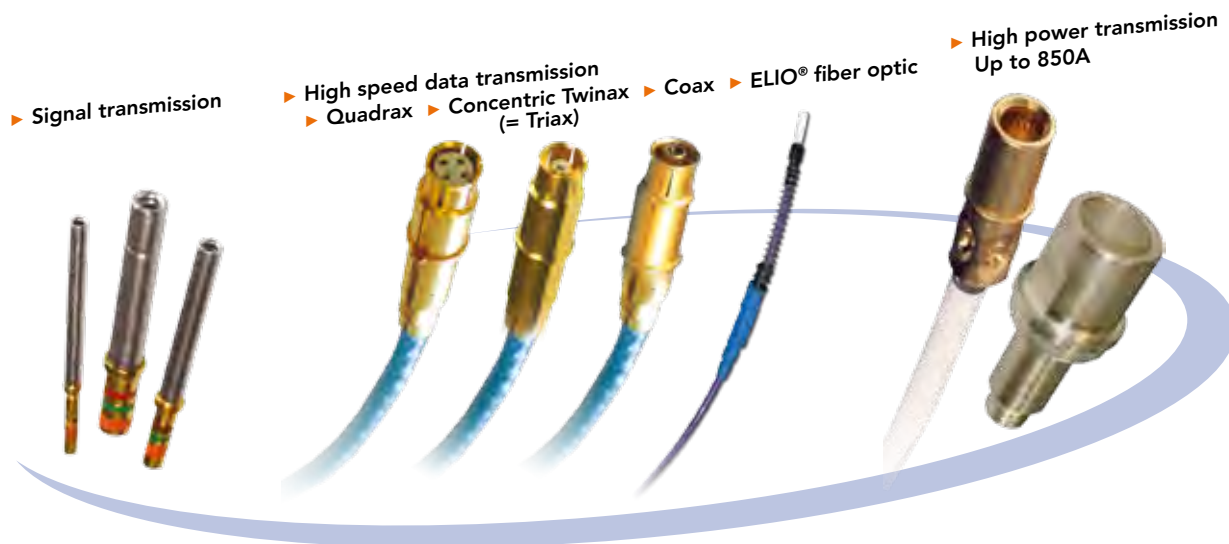

▶ Various contact styles

- ▶ Crimp
- ▶ Solder cup
- ▶ PC tails
- ▶ Wire wrap
- ▶ PCB contacts without shoulder

▶ Common cavity for all #8 contacts

### Metallic clips

▶ Unique clip retention technology

▶ High performance contact retention system:

- ▶ Insure high temperature withstanding
- ▶ Provides superior strength in vibrations
- ▶ Better retention characteristics than plastic clips

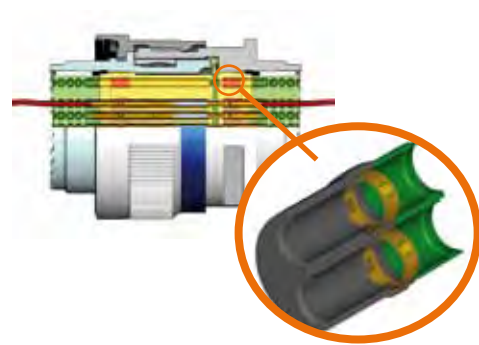

### High performance sealing

- ▶ IP67
- ▶ Each contact cavity is individually sealed

### Accessories available

- ▶ Protective caps, backshells, tools, ...

Note: Concentric Twinax = Triax

**Product overview - A performing MIL standard connector design**

**Scoop proof connector**

- ▶ No risk of damaging contacts during the coupling operation

**Self locking mechanism**

**Patented by SOURIAU**

- ▶ Connector will never unscrew even under high vibration (44g)

**Quick screw coupling**

- ▶ 1<sup>1/4</sup> turn to mate



**Fully shielded connector**

- ▶ 360° shielding

360° teeth for optimum shield continuity with accessories

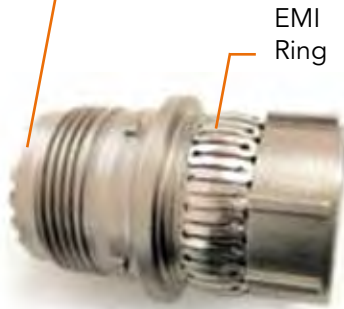

EMI Ring

- ▶ Shell to shell bottoming = perfect shield continuity

**Visual mating indication**

- ▶ Red band visible = not correctly mated



- ▶ Red band hidden = correctly mated



**A universal product platform**



**38999 Series I: 8LT Series**

MIL-DTL-38999

- ▶ High density MIL-spec circular
- ▶ Scoop proof
- ▶ Bayonet coupling
- ▶ Mounting: screws or jam nut
- ▶ Shell: Aluminum alloy
- ▶ Plating: Cadmium or nickel
- ▶ QPL approved
- ▶ Numerous layouts



**38999 Series II: 8T Series**

MIL-DTL-38999

- ▶ Short version of 38999 Series I
- ▶ High density MIL-spec circular
- ▶ Bayonet coupling
- ▶ Mounting: screws or jam nut
- ▶ Shell: Aluminum alloy
- ▶ Plating: Cadmium, nickel or hard anodized
- ▶ QPL approved



**8ST Series**

VG96912 & JN1003

- ▶ High density
- ▶ Lightweight version of Series I
- ▶ Scoop proof, bayonet coupling
- ▶ Mounting: screws or jam nut
- ▶ Shell: Aluminum alloy
- ▶ Plating: Cadmium or nickel
- ▶ VG 96912 German specification
- ▶ JN 1003 Typhoon specification



## Description

- High contact density layouts available **HD**
- Screw coupling, Shell size from 9 to 25
- Contact protection: 100% Scoop proof
- Protected by cadmium, nickel, green zinc cobalt or black zinc nickel plating
- RFI - EMI shielding and shell to shell continuity
- Accessories (protective caps, backshells, etc... )
- Hermetic versions
- High power up to 850A
- Optical layouts
- 230V layouts available (ABS22-19, ABS22-20, ABS22-21 & ABS22-22 qualified)
- Standards:
  - . MIL-DTL-38999 Series III
  - . EN3645
  - . BACC63CT/CU; BACC63DB/DC

## Technical features

### Mechanical

- **Shell:**  
Aluminum, composite, stainless steel, bronze
- **Shell plating:**
  - . Aluminum shell:
    - Cadmium olive drab (W)
    - Nickel (F)
    - Black zinc nickel (Z)
    - Green zinc cobalt (ZC)
  - . Composite shell:
    - Cadmium olive drab (J)
    - Nickel (M)
    - Without plating (X)
  - . Stainless steel shell:
    - Passivated (K)
    - Nickel (S)
  - . Titanium shell:
    - Without plating (TT)
    - Nickel (TF)
  - . Bronze shell:
    - Without plating
- **Insulator:** Thermoplastic
- **Grommet and interfacial seal:**  
Silicone elastomer

- **Contacts:** Copper alloy
- **Contacts plating:** Gold over nickel plated
- **Endurance:**
  - . 500 mating cycles all materials
  - . 1500 mating cycles for composite connectors with specifics contacts
- **Shock:**  
300g, 3 ms according EN 2591-D2 method A
- **Vibration:**
  - . Sinus:
    - . 10 à 2000 Hz, 3x12 hrs (60g, 140 - 2000 Hz) with T° cycling
  - . Random:
    - . 50 to 2000 Hz, 2x8 Hrs (1g2/ Hz, 100 - 2000Hz) at T° max.
    - . 25 to 2000 Hz, 2x8 Hrs (5g2/ Hz, 100 - 300Hz) at ambient T°
- **Contact retention:**

Contacts size	26	22	20	16	12	8	4
Min force in N	30	44	67	111	111	111	200

### Weight comparison

Example for a plug shell size 15

Materials	Weight	
Stainless steel	58.80 g	42% lighter
Titanium	33.90 g	
Aluminum	20.35 g	40% lighter
Compo-site	14.30 g	30% lighter

## Electrical

### • Test voltage rating (Vrms)

Service	sea level	at 21000 m
R	400	N/A
M	1 300	800
N	1 000	600
I	1 800	1 000
II	2 300	1 000

### • Contact resistance

Contacts size	26	22	20	16	12	8	4
Resistance mΩ	16	14.6	7.3	3.8	3.5	3	2

### • Insulation resistance:

≥ 5 000 MΩ (under 500 Vdc)

### • Contact rating:

Contacts size	26	22	20	16	12	8	4
Rating (A)	3	5	7.5	13	23	45	80

### • Shell continuity

- . Aluminum shell:
  - Cadmium olive drab (W): 2.5 mΩ
  - Nickel (F): 1 mΩ
  - Black zinc nickel (Z): 2.5 mΩ
  - Green zinc cobalt (ZC): 2.5 mΩ
- . Composite shell:
  - Cadmium olive drab (J): 3 mΩ
  - Nickel (M): 3 mΩ
- . Stainless steel shell:
  - Passivated (K): 10 mΩ
  - Nickel (S): 1 mΩ
- . Titanium shell:
  - Without plating (TT): 10 mΩ
  - Nickel (TF): 1 mΩ
- . Bronze shell:
  - Without plating: 5 mΩ

### • Shielding:

- . Aluminum shell:
  - F: 65 db at 10 GHz
  - Z, F & W: 85 db at 1 GHz
  - Z & W: 50 db at 10 GHz
  - ZC: Consult us
- . Composite shell:
  - J & M: 85 db at 1 GHz
- . Stainless steel shell:
  - K: 45 db at 10 GHz
  - S: 65 db at 10 GHz
- . Titanium shell:
  - TT: 45 db at 10 GHz
  - TF: 65 db at 10 GHz
- . Bronze shell:
  - 85 db at 10 GHz

## Environmental

### • Temperature range:

- . Aluminum shell:
  - W: -65°C +175°C
  - F: -65°C +200°C
  - Z: -65°C +200°C
  - ZC: -65°C +175°C
- . Composite shell:
  - J: -65°C +175°C
  - M: -65°C +200°C
  - Without plating (X): -65°C +175°
- . Stainless steel shell:
  - K: -65°C +200°C
  - S: -65°C +200°C
- . Titanium shell:
  - TT: -65°C +200°C
  - TF: -65°C +200°C
- . Bronze shell:
  - Without plating: -65°C +175°C

### • Sealing:

Mated connectors meet altitude immersion requirements of MIL-DTL-38999.

### • Salt spray:

- . Aluminum shell:
  - W: 500 Hrs
  - F: 48 Hrs
  - Z: 500 Hrs
  - ZC: 250 Hrs
- . Composite shell:
  - J: 2000 Hrs
  - M: 2000 Hrs
  - Without plating (X): 2000 Hrs
- . Stainless steel shell:
  - K: 500 Hrs
  - S: 500 Hrs
- . Titanium shell:
  - TT: 500 Hrs
  - TF: 48 Hrs
- . Bronze shell:
  - Without plating: 500 Hrs

## Resistance to fluids

### • According to MIL-DTL-38999 standard

- . Gasoline: JP5 (OTAN F44)
- . Mineral hydraulic fluid: MIL-H-5606 (OTAN H515)
- . Synthetic hydraulic fluid: Skydrol 500 B4

### • LD4 (SAE AS 1241)

- . Mineral lubricating: MIL-L-7870A (OTAN 0142)
- . Synthetic lubricating: MIL-L-23699 (OTAN 0156), MIL-L-7808
- . Cleaning fluid: MIL-C-87936 diluted
- . De-icing fluid: MIL-A-8243
- . Extinguishing fluid: Bromochloromethane
- . Cooling fluid: Coolanol

## Contact layouts

-  Contact #26 & #22D
-  Contact #20
-  Contact #16
-  Contact #12
-  Contact #10
-  Contact #8 Coax or Concentric Twinax - consult us
-  Contact #8 Power
-  Contact #8 Quadrax
-  Contact ELIO® (fiber optic)
-  Contact #4 Power

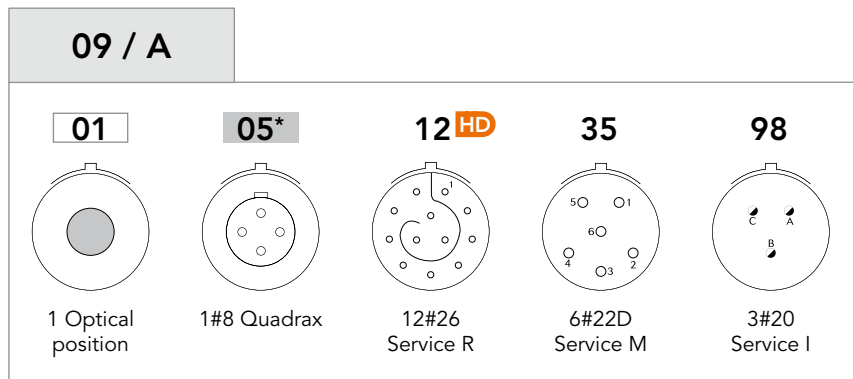

\*09-05 layout:  
 - Grounded version only (spec. 620)  
 - Plug with female contact & receptacle with male contact only

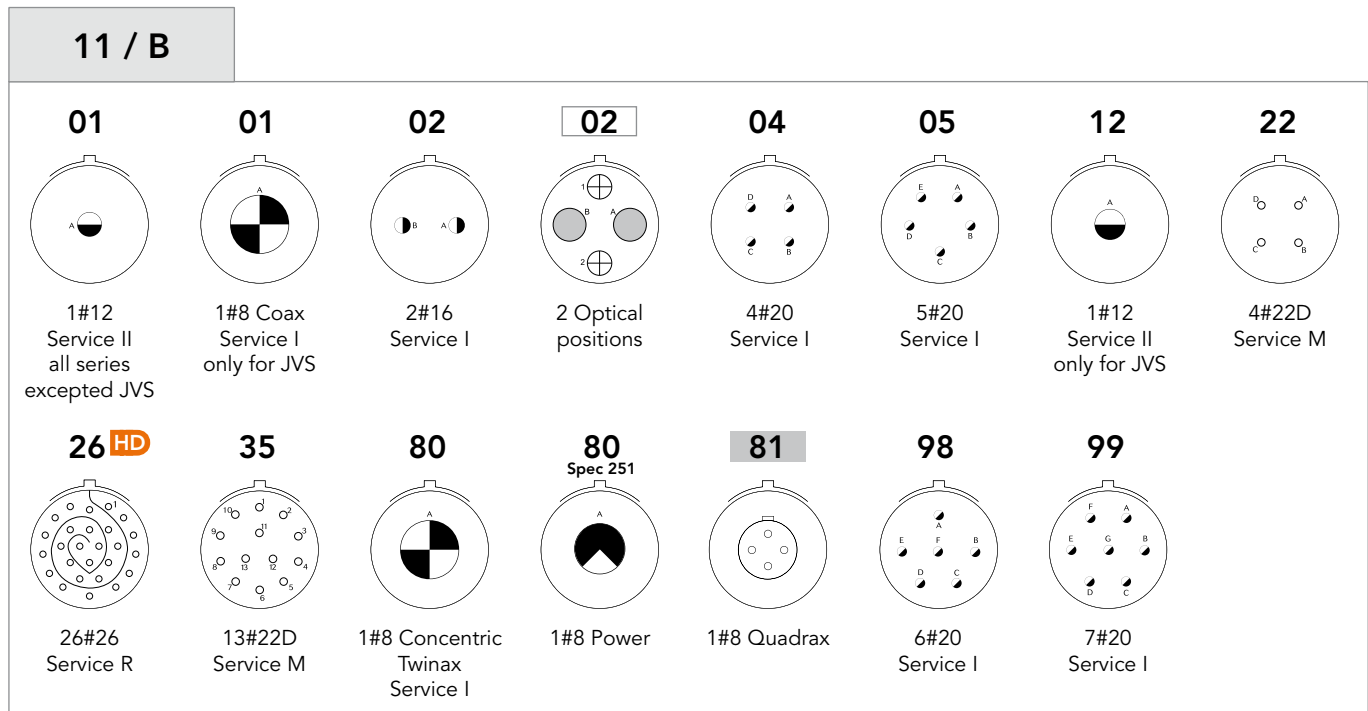

ELIO® fiber optic     Ethernet Quadrax    HD High Density layout    Note: Concentric Twinax = Triax

## Contact layouts

### 13 / C

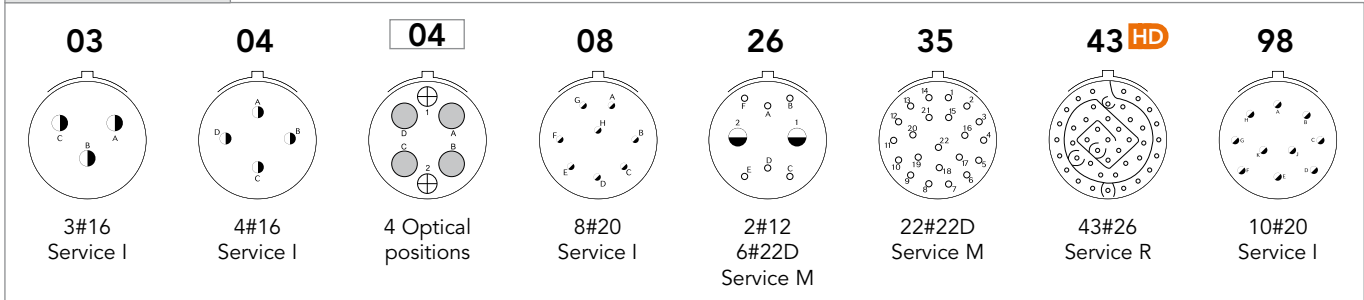

### 15 / D

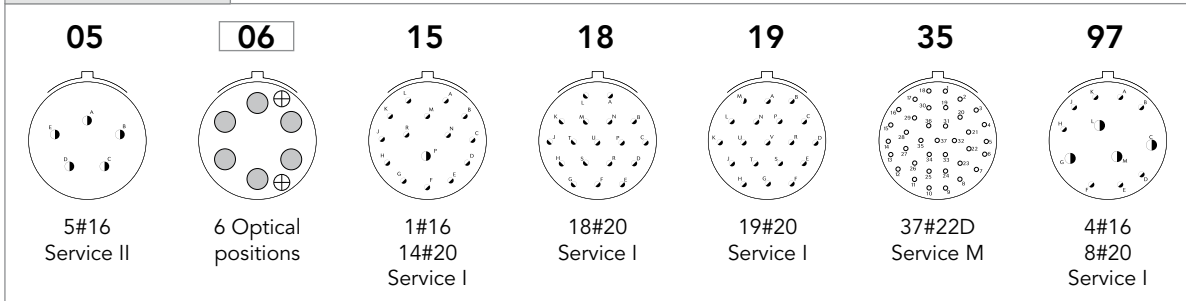

## Contact layouts

**17 / E**

<p><b>02</b></p> <p>38#22D 1#8 Concentric Twinax Service M</p>	<p><b>02</b> Spec 251</p> <p>38#22D 1#8 Power</p>	<p><b>06</b></p> <p>6#12 Service I</p>	<p><b>08</b></p> <p>8#16 Service II</p>	<p><b>20</b></p> <p>4#12 16#22D Service M</p>	<p><b>22</b></p> <p>2#12 2#8 Concentric Twinax Service M</p>	<p><b>22</b> Spec 251</p> <p>2#12 2#8 Power</p>	<p><b>26</b></p> <p>26#20 Service I</p>
<p><b>35</b></p> <p>55#22D Service M</p>	<p><b>75</b></p> <p>2#8 Concentric Twinax Service M</p>	<p><b>75</b> Spec 251</p> <p>2#8 Power</p>	<p><b>80</b></p> <p>2#12 2#8 Quadrax</p>	<p><b>81</b></p> <p>38#22D 1#8 Quadrax</p>	<p><b>82</b></p> <p>2#8 Quadrax</p>	<p><b>99</b></p> <p>2#16 21#20 Service I</p>	

**19 / F**



<p><b>08</b></p> <p>8 Optical positions</p>	<p><b>11</b></p> <p>11#16 Service II</p>	<p><b>18</b></p> <p>14#22D 4#8 Concentric Twinax Service M</p>	<p><b>18</b> Spec 251</p> <p>14#22D 4#8 Power</p>	<p><b>28</b></p> <p>26#20 2#16 Service I</p>	<p><b>32</b></p> <p>32#20 Service I</p>	<p><b>35</b></p> <p>66#22D Service M</p>	<p><b>84</b></p> <p>14#22D 4#8 Quadrax</p>
<p><b>H1</b></p> <p>1#00 High power</p>							

## Contact layouts

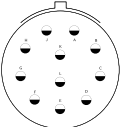
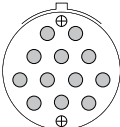
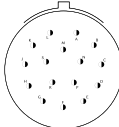
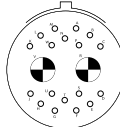
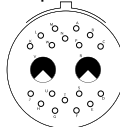
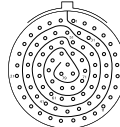
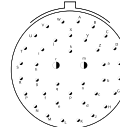
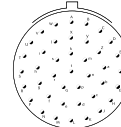
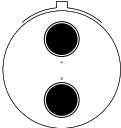
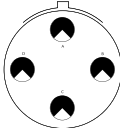
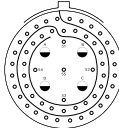
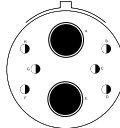
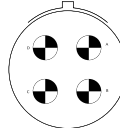
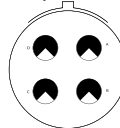
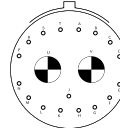
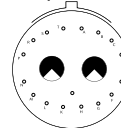
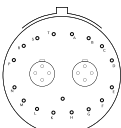
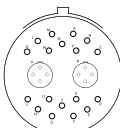
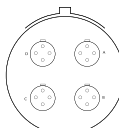
### 21 / G

<p><b>11</b></p>  <p>11#12 Service I</p>	<p><b>12</b></p>  <p>12 Optical positions</p>	<p><b>16</b></p>  <p>16#16 Service II</p>	<p><b>20</b></p>  <p>18#20 2#8 Concentric Twinax Service M</p>	<p><b>20</b> Spec 251</p>  <p>18#20 2#8 Power</p>	<p><b>35</b></p>  <p>79#22D Service M</p>	<p><b>39</b></p>  <p>2#16 37#20 Service I</p>	<p><b>41</b></p>  <p>41#20 Service I</p>
<p><b>42</b></p>  <p>2#4 Power Service I</p>	<p><b>48</b></p>  <p>4#8 Power Service I</p>	<p><b>59</b></p>  <p>55#22D 4#12 Service M</p>	<p><b>72</b></p>  <p>6#16 2#4 Power Service I</p>	<p><b>75</b></p>  <p>4#8 Concentric Twinax Service M</p>	<p><b>75</b> Spec 251</p>  <p>4#8 Power</p>	<p><b>77</b></p>  <p>17#22D 2#8 Concentric Twinax Service M</p>	<p><b>77</b> Spec 251</p>  <p>17#22D 2#8 Power</p>
<p><b>78</b></p>  <p>17#22D 2#8 Quadrax</p>	<p><b>80</b></p>  <p>18#20 2#8 Quadrax</p>	<p><b>84</b></p>  <p>4#8 Quadrax</p>					

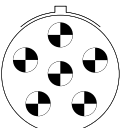
### 23 / H

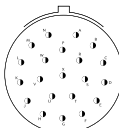
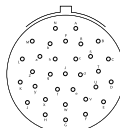
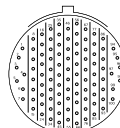
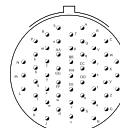
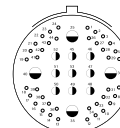
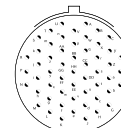
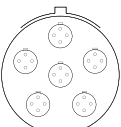
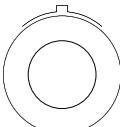
<p><b>06</b></p>  <p>6#8 Concentric Twinax Service M</p>	<p><b>06</b> Spec 251</p>  <p>6#8 Power Service M</p>	<p><b>21</b></p>  <p>21#16 Service II</p>	<p><b>32</b></p>  <p>32#20 Service I</p>	<p><b>35</b></p>  <p>100#22D Service M</p>	<p><b>53</b></p>  <p>53#20 Service I</p>	<p><b>54</b></p>  <p>4#12, 9#16 40#22D Service M</p>	<p><b>55</b></p>  <p>55#20 Service I</p>
<p><b>86</b></p>  <p>6#8 Quadrax</p>	<p><b>H1</b></p>  <p>1#000 High power</p>						



 ELIO® fiber optic  Ethernet Quadrax

Note: Concentric Twinax = Triax

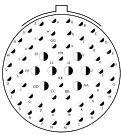
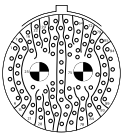
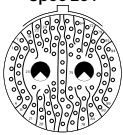
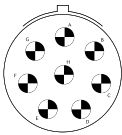
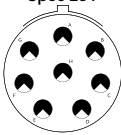
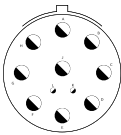
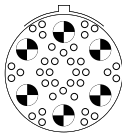
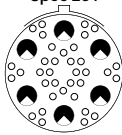
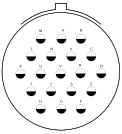
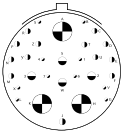
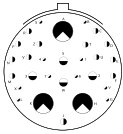
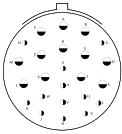
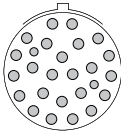
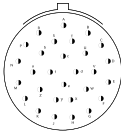
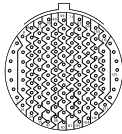
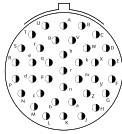
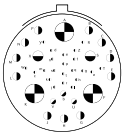
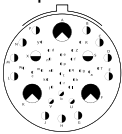
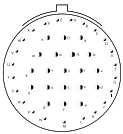
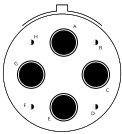
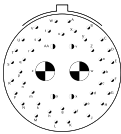
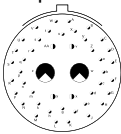
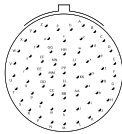
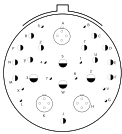
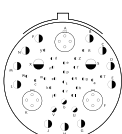
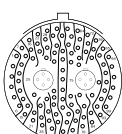
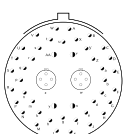
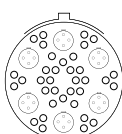
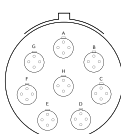

# Contact layouts

25 / J

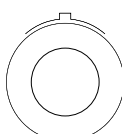
<p><b>04</b></p>  <p>48#20 8#16 Service I</p>	<p><b>07</b></p>  <p>97#22D 2#8 Concentric Twinax Service M</p>	<p><b>07</b> Spec 251</p>  <p>97#22D 2#8 Power</p>	<p><b>08</b></p>  <p>8#8 Concentric Twinax Service M</p>	<p><b>08</b> Spec 251</p>  <p>8#8 Power</p>	<p><b>11</b></p>  <p>2#20 9#10 Service N</p>	<p><b>17</b></p>  <p>36#22D 6#8 Concentric Twinax</p>	<p><b>17</b> Spec 251</p>  <p>36#22D 6#8 Power</p>
<p><b>19</b></p>  <p>19#12 Service I</p>	<p><b>20*</b></p>  <p>10#20, 13#16 4#12 Coax 3#8 Concentric Twinax Service N</p>	<p><b>20*</b> Spec 251</p>  <p>10#20 13#16, 4#12 3#8 Power</p>	<p><b>24</b></p>  <p>12#16 12#12 Service I</p>	<p><b>24</b></p>  <p>24 Optical positions</p>	<p><b>29</b></p>  <p>29#16 Service I</p>	<p><b>35</b></p>  <p>128#22D Service M</p>	<p><b>37</b></p>  <p>37#16 Service II</p>
<p><b>41</b></p>  <p>22#22D, 3#20 11#16, 2#12 3#8 Concentric Twinax Service M</p>	<p><b>41</b> Spec 251</p>  <p>22#22D, 3#20 11#16, 2#12 3#8 Power</p>	<p><b>43</b></p>  <p>23#20 20#16 Service I</p>	<p><b>44</b></p>  <p>4#16 4#4 Power Service I</p>	<p><b>46</b></p>  <p>40#20, 4#16 2#8 Coax Service I</p>	<p><b>46</b> Spec 251</p>  <p>40#20, 4#16 2#8 Power Service I</p>	<p><b>61</b></p>  <p>61#20 Service I</p>	<p><b>80</b></p>  <p>10#20 13#16 4#12 Coax 3#8 Quadrax</p>
<p><b>81</b></p>  <p>22#22D 3#20, 11#16 2#12 3#8 Quadrax</p>	<p><b>82</b></p>  <p>97#22D 2#8 Quadrax</p>	<p><b>86</b></p>  <p>40#20 4#16 2#8 Quadrax</p>	<p><b>87</b></p>  <p>36#22D 6#8 Quadrax</p>	<p><b>88</b></p>  <p>8#8 Quadrax</p>	<p><b>90</b></p>  <p>40#20, 4#16 2#8 Concentric Twinax Service I</p>	<p><b>H1</b></p>  <p>1#0000 High power</p>	

ELIO® fiber optic Ethernet Quadrax

\* For classes F, W, K, S only

Note: Concentric Twinax = Triax

## Contact layouts (matrix)

Shell size	Layout	MIL-DTL-38999 (OPL) Aluminum, Stainless steel & Composite	8D Titanium	JVS-CECC Bronze connector	Hermetics	EN3645	BACC63 CT/CU DB/DC	Number of contacts	#26	#22D	#20	#16	#12	#10	#8	#4	Fiber optic or High power
09 / A	09-01	OK	OK	OK				1									1 Optic.
	09-05 (1)	OK	OK	OK				1							1 Qdx		
	09-12	OK						12	12								
	09-35	Q	OK	Q	OK	Q	Q	6		6							
	09-98	Q	OK	Q	OK	Q	Q	3			3						
11 / B	11-01	OK	OK					1					1				
	11-01	OK	OK	OK				1							1 Coax		
	11-02	Q	OK	Q		Q	Q	2				2					
	11-02	OK	OK	OK				2									2 Optic.
	11-04	Q	OK	OK			Q	4			4						
	11-05	Q	OK	Q		Q	Q	5			5						
	11-12			OK				1					1				
	11-22	OK	OK	OK				4		4							
	11-26	OK						26	26								
	11-35	Q	OK	Q	OK	Q	Q	13		13							
	11-80	OK	OK	OK				1								1 Twx	
	11-80 sp.251	OK	OK	OK				1								1 Pow	
	11-81	OK	OK	OK				1								1 Qdx	
	11-98	Q	OK	Q	OK	Q	Q	6			6						
11-99	Q	OK	Q		Q	Q	7			7							
13 / C	13-03	OK	OK	OK				3									
	13-04	Q	OK	Q	OK	Q	Q	4				4					
	13-04	OK	OK	OK				4									4 Optic.
	13-08	Q	OK	Q	OK	Q	Q	8			8						
	13-26	OK	OK	Q		Q		8		6			2				
	13-35	Q	OK	Q	OK	Q	Q	22		22							
	13-43	OK						43	43								
13-98	Q	OK	Q	OK	Q	Q	10			10							
15 / D	15-05	Q	OK	Q		Q	Q	5				5					
	15-06	OK	OK	OK				6									6 Optic
	15-15	Q	OK	Q		Q	Q	15			14	1					
	15-18	Q	OK	Q	OK	Q	Q	18			18						
	15-19	Q	OK	Q	OK	Q	Q	19			19						
	15-35	Q	OK	Q	OK	Q	Q	37		37							
15-97	Q	OK	Q	OK	Q	Q	12			8	4						
17 / E	17-02	Q	OK	OK		Q	Q	39		38						1 Twx	
	17-02 sp.251	OK	OK	OK				39		38						1 Pow	
	17-06	Q	OK	Q	OK	Q	Q	6					6				
	17-08	Q	OK	Q	OK	Q	Q	8				8					
	17-20	OK	OK	OK				20		16			4				
	17-22	OK	OK	OK				4					2			2 Twx	
	17-22 sp.251	OK	OK	OK				4					2			2 Pow	
	17-26	Q	OK	Q	OK	Q	Q	26			26						
	17-35	Q	OK	Q	OK	Q	Q	55		55							
	17-75	OK	OK	OK				2								2 Twx	
	17-75 sp.251	OK	OK	OK				2								2 Pow	
	17-80	OK	OK	OK				4					2			2 Qdx	
	17-81	OK	OK	OK				39		38						1 Qdx	
17-82	OK	OK	OK			Q	2								2 Qdx		
17-99	Q	OK	Q		Q	Q	23			21	2						
19 / F	19-08	OK	OK	OK				8									8 Optic.
	19-11	Q	OK	Q		Q	Q	11				11					
	19-18	Q	OK	OK			Q	18		14					4 Twx		
	19-18 sp.251	OK	OK	OK													
	19-28	Q	OK	Q		Q	Q	28			26	2					
	19-32	Q	OK	Q		Q	Q	32			32						
	19-35	Q	OK	Q	OK	Q	Q	66		66							
19-84	OK	OK	OK				18		14					4 Qdx			
19-H1	OK						1									1 #00	

- OK SOURIAU's layout
- Q SOURIAU's layout & Layout according to corresponding norm
- (1) Grounded insert only - Please consult us
- #8 Pow: Power; Qdx: Quadrax; Twx: Concentric Twinax

## Contact layouts (matrix)

Shell size	Layout	MIL-DTL-38999 (OPL) Aluminum, Stainless steel & Composite	8D Titanium	JVS-CECC Bronze connector	Hermetics	EN3645	BACC63 CT/CU DB/DC	Number of contacts	#26	#22D	#20	#16	#12	#10	#8	#4	Fiber optic or High power
21 / G	21-11	Q	OK	Q		Q	Q	11					11				
	21-12	OK	OK	OK				12									12 Optic
	21-16	Q	OK	Q		Q	Q	16				16					
	21-20	OK	OK	OK		Q		20			18				2 Twx		
	21-20 sp.251	OK	OK	OK				20			18				2 Pow		
	21-35	Q	OK	Q		Q	Q	79		79							
	21-39	Q	OK	Q		Q	Q	39			37	2					
	21-41	Q	OK	Q	OK	Q	Q	41			41						
	21-42	OK	OK	OK				2									2 Pow
	21-48	OK	OK	Q	OK	OK		4							4 Pow		
	21-59	OK	OK	OK	OK			59		55			4				
	21-72	OK	OK	OK	OK			8				6					2 Pow
	21-75	Q	OK	OK	OK		Q	Q	4						4 Twx		
	21-75 sp.251	OK	OK	OK	OK			4							4 Pow		
	21-77	OK	OK	OK	OK			19		17					2 Twx		
21-77 sp.251	OK	OK	OK	OK			19		17					2 Pow			
21-78	OK	OK	OK	OK			19		17					2 Qdx			
21-80	OK	OK	OK	OK			20			18				2 Qdx			
21-84	OK	OK	OK	OK			4							4 Qdx			
23 / H	23-06	OK	OK	OK				6							6 Twx		
	23-06 sp.251	OK	OK	OK				6							6 Pow		
	23-21	Q	OK	Q		Q	Q	21				21					
	23-32	Q	OK	OK	OK			32			32						
	23-35	Q	OK	Q		Q	Q	100		100							
	23-53	Q	OK	Q	OK	Q	Q	53			53						
	23-54	OK	OK	OK	OK		Q	53		40		9	4				
	23-55	Q	OK	Q	OK	OK	Q	55			55						
23-86	OK	OK	OK	OK			6							6 Qdx			
23-H1	OK						1									1 #000	
25 / J	25-04	Q	OK	OK	OK	Q	Q	56			48	8					
	25-07	Q	OK	OK	OK		Q	99		97					2 Twx		
	25-07 sp.251	OK	OK	OK	OK			99		97					2 Pow		
	25-08	Q	OK	Q <sup>(2)</sup>		Q	Q	8							8 Twx		
	25-08 sp.251	OK	OK	OK	OK			8							8 Pow		
	25-11	Q	OK	OK	OK		Q	11			2			9			
	25-17	OK	OK	OK	OK			42		36					6 Twx		
	25-17 sp.251	OK	OK	OK	OK			42		36					6 Pow		
	25-19	Q	OK	Q	OK	OK		19					19				
	25-20	Q	OK	OK <sup>(3)</sup>		Q <sup>(4)</sup>	Q <sup>(5)</sup>	30			10	13	4 <sup>(6)</sup>		3 Twx		
	25-20 sp.251	OK	OK	OK	OK			30			10	3	4		3 Pow		
	25-24	Q	OK	Q		Q	Q	24				12	12				
	25-24	OK	OK	OK	OK			24									24 Optic.
	25-29	Q	OK	Q		Q	Q	29				29					
	25-35	Q	OK	Q		Q	Q	128		128							
	25-37	Q	OK	OK	OK		Q	Q	37				37				
	25-41	OK	OK	OK	OK			41		22	3	11	2		3 Twx		
	25-41 sp.251	OK	OK	OK	OK			41		22	3	11	2		3 Pow		
	25-43	Q	OK	Q		Q	Q	43			23	20					
	25-44	OK	OK	OK	OK			8				4				4 Pow	
25-46	Q	OK	OK	OK		Q	Q	46		40	4			2 Coax			
25-46 sp.251	OK	OK	OK	OK			46		40	4				2 Pow			
25-61	Q	OK	Q		Q	Q	61		61								
25-80	OK	OK	OK	OK			30			10	13	4		3 Qdx			
25-81	OK	OK	OK	OK			41		22	3	11	2		3 Qdx			
25-82	OK	OK	OK	OK			99		97					2 Qdx			
25-86	OK	OK	OK	OK			46			40	4			2 Qdx			
25-87	OK	OK	OK	OK			42		36					6 Qdx			
25-88	OK	OK	OK	OK			8							8 Qdx			
25-90	Q	OK	OK	OK			46			40	4			2 Twx			
25-H1	OK						1									1 #0000	

OK Souriau's layout

Q Souriau's layout & Layout according to corresponding norm

(2) For CECC, layout 25-08 only delivered without contact

(3) For classes F, W, S, K only

(4) For classes F, W, K only

(5) Qualified BACC63DB/DC only

(6) 4 #12 coax (2+2)

#8 Pow: Power; Qdx: Quadrax; Twx: Concentric Twinax

# 8D SERIES

# Standard Series

■ Aluminum Series:	
Part numbers .....	22
Dimensions .....	24
Connectors weight .....	27
Backshells .....	28
Metallic caps .....	34
■ Composite Series:	
Part numbers .....	35
Dimensions .....	37
Connectors weight .....	39
Backshells .....	40
■ Stainless Steel Series:	
Part numbers .....	41
Dimensions .....	43
Connectors weight .....	46
■ Titanium Series:	
Part numbers .....	47
Dimensions .....	48
Connectors weight .....	51
■ Bronze Series:	
Part numbers .....	52
Dimensions .....	53
Connectors weight .....	56
Backshells .....	57
Metallic caps .....	61

## Connector part numbers

<b>Basic Series</b>	<b>8D</b>	<b>0</b>	<b>-</b>	<b>11</b>	<b>W</b>	<b>35</b>	<b>P</b>	<b>N</b>			<b>L</b>
<p><b>Shell style:</b></p> <ul style="list-style-type: none"> <li><b>0:</b> Square flange receptacle</li> <li><b>1:</b> In line receptacle</li> <li><b>7:</b> Jam nut receptacle</li> <li><b>5:</b> Plug with RFI shielding</li> </ul> <p>Also available:</p> <ul style="list-style-type: none"> <li>. Square flange receptacle with clinch nuts or helicoils (see page 96)</li> <li>. Jam nut receptacle with double flange (see page 99)</li> </ul>											
<p><b>Type:</b></p> <ul style="list-style-type: none"> <li>- : Connectors with standard crimp contacts.</li> <li><b>L:</b> Receptacle with long PC tail (male and female size #22D, #20).</li> <li><b>C:</b> Receptacle with short PC tail (male and female #22D, #20, #16, #12).</li> <li><b>S:</b> Receptacle with specific PC tail (male et female #22D)</li> <li><b>W:</b> Receptacle with male contacts #22D for wire wrap (3 wraps)</li> <li><b>T:</b> Receptacle with male contacts #20 for wire wrap (2 wraps)</li> <li><b>P:</b> Receptacle with solder cup contacts - please consult us                             <ul style="list-style-type: none"> <li>. see page 86 for Reinforced sealing Series with solder cup contacts</li> <li>. see page 69 for solder cup contacts information</li> </ul> </li> </ul>											
<p><b>Shell size: 09, 11, 13, 15, 17, 19, 21, 23, 25</b></p>											
<p><b>Plating:</b></p> <ul style="list-style-type: none"> <li><b>W:</b> Olive drab cadmium</li> <li><b>F:</b> Nickel</li> <li><b>ZC:</b> Green zinc cobalt</li> <li><b>Z:</b> Black zinc nickel</li> </ul>											
<p><b>Contact layout:</b> See pages 13 to 19</p>											
<p><b>Contact type:</b></p> <ul style="list-style-type: none"> <li><b>P:</b> Pin</li> <li><b>A:</b> Connector supplied less pin contact or with specific contacts (connector marking: A + orientation)</li> <li><b>S:</b> Socket</li> <li><b>B:</b> Connector supplied less socket contact or with specific contacts (connector marking: B + orientation)</li> </ul>											
<p><b>Orientation: N, A, B, C, D, E</b> (see page 75)</p>											
<p><b>Specification:</b></p> <ul style="list-style-type: none"> <li><b>046:</b> Tinned straight PC tail</li> <li><b>251:</b> Connector provided with power contacts (layouts with contact #8)</li> <li><b>022:</b> Fuel tank</li> </ul>											
<p><b>Special custom:</b></p> <ul style="list-style-type: none"> <li><b>None:</b> Standard plastic cap</li> <li><b>M:</b> Antistatic plastic cap</li> </ul>											
<p><b>L:</b> For P or S contact type only, connectors delivered without contacts, connectors marking P or S plus orientation</p>											

Note: PC tail contacts without shoulder also available. Please see page 102.

## MIL-DTL-38999 part numbers

<b>Basic Series</b>	D38999/	20	W	B	35	P	N	L
<b>Shell style:</b>								
20: Square flange receptacle								
24: Jam nut receptacle								
26: Plug with RFI shielding.								
<b>Plating:</b>								
Z: Black zinc nickel								
W: Olive drab cadmium								
F: Nickel								
<b>Shell size: A, B, C, D, E, F, G, H, J</b>								
<b>Contact layout:</b> See page 18 for layout according to MIL-DTL-38999								
<b>Contact type:</b>								
P: Pin								
A: Connector supplied less pin contact or with specific contacts (connector marking: A + orientation)								
S: Socket								
B: Connector supplied less socket contact or with specific contacts (connector marking: B + orientation)								
<b>Orientation: N, A, B, C, D, E (see page 75)</b>								
L: For P or S contact type only, connector delivered without contacts, connector marking P or S (without L)								

Note: To place an order of MIL connectors delivered without MIL removable crimp contacts and keep P or S plus orientation marking, it must be specified clearly on the order (by adding a suffix L at the end of the P/N or specified in comment).  
Delivered with MIL contacts mandatory.

## EN3645 part numbers

<b>Basic Series</b>	EN3645	W	6	G	N	35	B	N
<b>Plating:</b>								
W: Olive drab cadmium								
F: Nickel								
<b>Shell style:</b>								
0: Square flange receptacle								
6: Plug								
7: Jam nut receptacle								
<b>Shell size:</b>								
09=A, 11=B, 13=C, 15=D, 17=E, 19=F, 21=G, 23=H, 25=J								
<b>Grounding:</b>								
N: Standard insert not grounded								
<b>Contact layout:</b>								
See page 18 for layout according to EN3645								
<b>Contact type:</b>								
A: Connector supplied less pin contact								
B: Connector supplied less socket contact								
F: Socket								
M: Pin								
<b>Orientation:</b>								
N, A, B, C, D, E (see page 75)								

## Dimensions

### Plug type 5

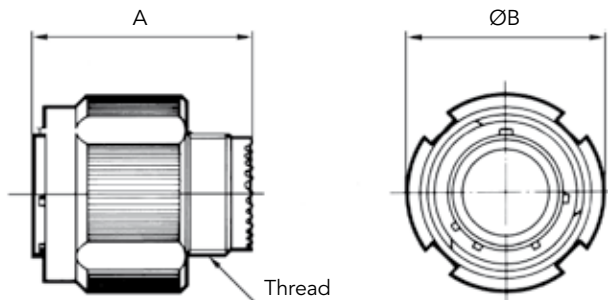

Shell size	A Max	Thread	ØB Max
09 (A)	31.00	M12 x 1-6g	21.80
11 (B)		M15 x 1-6g	25.00
13 (C)		M18 x 1-6g	29.40
15 (D)		M22 x 1-6g	32.50
17 (E)		M25 x 1-6g	35.70
19 (F)		M28 x 1-6g	38.50
21 (G)		M31 x 1-6g	41.70
23 (H)		M34 x 1-6g	44.90
25 (J)		M37 x 1-6g	48.00

### Receptacle type 1

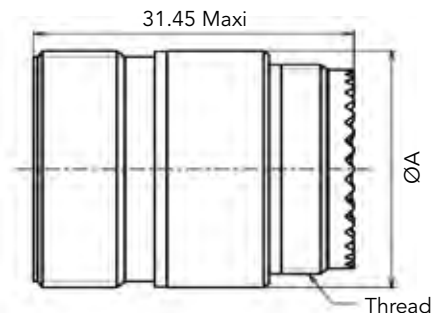

Shell size	Thread	ØA
09 (A)	M12 x 1-6g	15.90
11 (B)	M15 x 1-6g	19.00
13 (C)	M18 x 1-6g	22.25
15 (D)	M22 x 1-6g	25.45
17 (E)	M25 x 1-6g	30.20
19 (F)	M28 x 1-6g	31.75
21 (G)	M31 x 1-6g	34.95
23 (H)	M34 x 1-6g	38.10
25 (J)	M37 x 1-6g	41.30

### Receptacle type 7

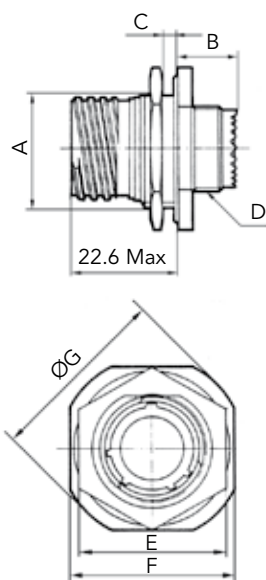

Shell size	A <sup>±0.15</sup>	B Max	C Max	D Thread	E Max	F <sup>±0.4</sup>	ØG Max
09 (A)	16.53	9.9	3.2	M12 x 1-6g	23	27	30.5
11 (B)	19.07			M15 x 1-6g	26	31.8	35.2
13 (C)	23.82			M18 x 1-6g	31	34.9	38.4
15 (D)	26.97			M22 x 1-6g	34	38.1	41.6
17 (E)	30.15			M25 x 1-6g	37	41.3	44.8
19 (F)	33.32			M28 x 1-6g	41	46	49.5
21 (G)	36.50			M31 x 1-6g	46	49.2	52.7
23 (H)	39.67			M34 x 1-6g	47	52.4	55.9
25 (J)	42.85			M37 x 1-6g	51.23	55.6	59

#### Recommended coupling torque on panel for jam nut receptacle (type 7)

Shell	09 (A)	11 (B)	13 (C)	15 (D)	17 (E)	19 (F)	21 (G)	23 (H)	25 (J)
Coupling torque (±0.5 N.m)	4	5	7	8	9	10	12	13	14

Note: All dimensions are in millimeters (mm)



### Receptacle type 0

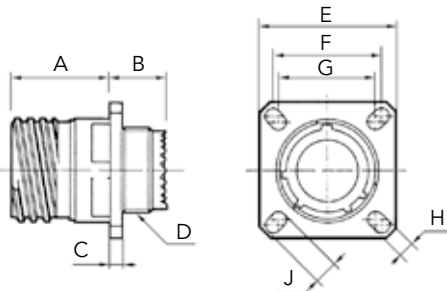

Shell size	A Max	B Max	C Max	D Thread	E <sup>±0.3</sup>	F	G	H <sup>±0.2</sup>	J <sup>±0.2</sup>
09 (A)	20.9	10.72	2.5	M12 x 1-6g	23.8	18.26	15.09	3.25	5.49
11 (B)				M15 x 1-6g	26.2	20.62	18.26		4.93
13 (C)				M18 x 1-6g	28.6	23.01	20.62		4.45
15 (D)				M22 x 1-6g	31	24.61	23.01		4.93
17 (E)				M25 x 1-6g	33.3	26.97	24.61		4.93
19 (F)	20.07	11.54	3.2	M28 x 1-6g	36.5	29.36	26.97	3.91	6.15
21 (G)				M31 x 1-6g	39.7	31.75	29.36		
23 (H)				M34 x 1-6g	42.9	34.93	31.75		
25 (J)				M37 x 1-6g	46	38.1	34.93		

### Mated connectors

Type 0 with plug

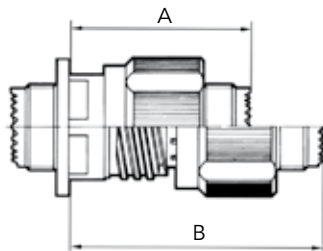

Type 7 with plug

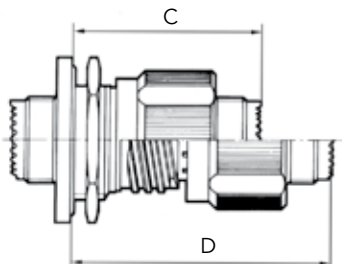

Shell size	A Max	B Max	C Max	D Max
09 to 11	37.00	52.30	38.30	53.60
13 to 19	37.00	52.30	38.50	53.80
21 to 25	36.00	51.30	38.50	53.80

### Dummy receptacle

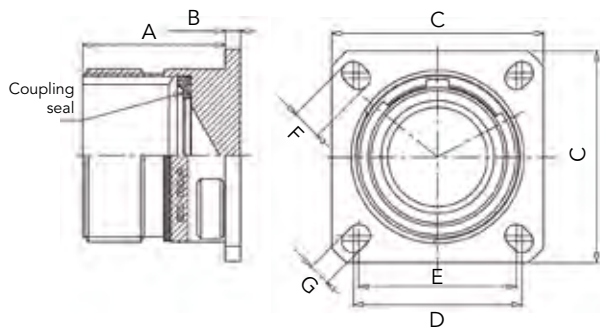

Shell size	Part number	A Max	B Max	C <sup>±0.30</sup>	D	E	F <sup>±0.20</sup>	G <sup>±0.20</sup>
09	8D0-09•UR	20.90	2.50	23.80	18.26	15.09	4.49	3.25
11	8D0-11•UR	20.90	2.50	26.20	20.62	18.26	4.93	3.25
13	8D0-13•UR	20.90	2.50	28.60	23.01	20.62	4.93	3.25
15	8D0-15•UR	20.90	2.50	31.00	24.61	23.01	4.93	3.25
17	8D0-17•UR	20.90	2.50	33.30	26.97	24.61	4.93	3.25
19	8D0-19•UR	20.90	2.50	36.50	26.97	24.61	4.93	3.25
21	8D0-21•UR	20.10	3.20	39.70	31.75	29.36	4.93	3.25
23	8D0-23•UR	20.10	3.20	42.90	34.93	31.75	6.15	3.91
25	8D0-25•UR	20.10	3.20	46.00	38.10	34.93	6.15	3.91

•: "G" for Olive green cadmium; "F" for Nickel.

Note: All dimensions are in millimeters (mm)

Receptacle with straight PC tail contacts

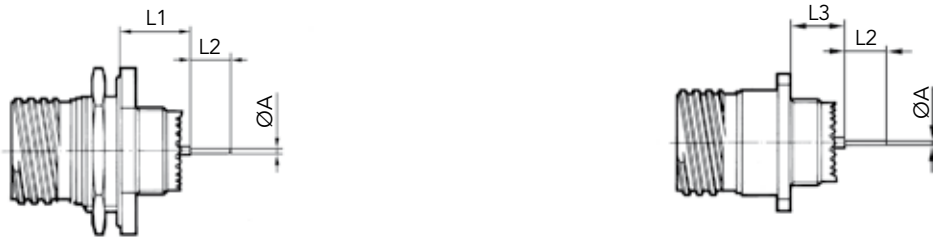

		Shell size			09 (A)	11 (B)	13 (C)	15 (C)	17 (E)	19 (F)	21 (G)	23 (H)	25 (J)
		Contact size	Contact type	PC tail type									
A		#22D	M & F	L & C					0.70				
		#22D	M & F	S					0.50				
		#20	M & F	C					0.70				
		#16	M & F	C					1.12 <sup>±0.03</sup>				
L1	Min	#22D	M	L & C	10.52					10.34			
	Max	#22D	M	L & C	11.46					11.28			
	Min	#22D	F	L & C	10.19					10.01			
	Max	#22D	F	L & C	11.46					11.28			
	Min	#22D	M	S	10.19					10.01			
	Max	#22D	M	S	11.46					11.28			
	Min	#22D	F	S	10.69					10.51			
	Max	#22D	F	S	11.63					11.45			
	Min	#20	M	C	10.36					10.18			
	Max	#20	M	C	11.63					11.45			
	Min	#20	F	C	10.69					10.51			
	Max	#20	F	C	11.63					11.45			
	Min	#16	M	C	10.69					10.51			
	Max	#16	M	C	11.63					11.45			
	Min	#16	F	C	10.69					10.51			
	Max	#16	F	C	11.63					11.45			
L2		#22D	M & F	L					8.50				
		#22D	M & F	C					4.00				
		#22D	M & F	S					5.10				
		#20	M & F	C					5.10				
		#16	M & F	C					5 <sup>±0.1</sup>				
L3	Min	#22D	M	L & C			9.48					9.59	
	Max	#22D	M	L & C			10.58					10.69	
	Min	#22D	F	L & C			9.15					9.26	
	Max	#22D	F	L & C			10.58					10.69	
	Min	#22D	M	S			9.65					9.76	
	Max	#22D	M	S			10.75					10.86	
	Min	#22D	F	S			9.15					9.26	
	Max	#22D	F	S			10.75					10.86	
	Min	#20	M	C			9.65					9.76	
	Max	#20	M	C			10.75					10.86	
	Min	#20	F	C			9.65					9.76	
	Max	#20	F	C			10.75					10.86	
	Min	#16	M	C			9.64					9.75	
	Max	#16	M	C			10.75					10.86	
	Min	#16	F	C			9.64					9.75	
	Max	#16	F	C			10.75					10.86	

M: Male contact    F: Female contact    L: Long PC tail    C: Short PC tail    S: Specific PC tail

Note: All dimensions are in millimeters (mm)

**Connectors weight** - in gram ( $\pm 15\%$ )

Shell size & Layout		With contacts						Without contacts					
		Plug (type 5)		Receptacle (type 0)		Receptacle (type 7)		Plug (type 5)		Receptacle (type 0)		Receptacle (type 7)	
		Male	Female	Male	Female	Male	Female	Male	Female	Male	Female	Male	Female
09	35	11.47	13.05	9.15	10.73	13.91	15.49	11.05	11.55	8.73	9.23	13.49	13.99
	98	11.47	12.77	9.15	10.45	13.91	15.21	11.05	11.57	8.73	9.25	13.49	14.01
11	01	14.98	17.92	12.01	14.95	18.17	21.11	14.32	16.32	11.35	13.35	17.51	19.51
	02	14.61	17.15	11.64	14.18	17.80	20.34	13.99	15.59	11.02	12.62	17.18	18.78
	04	14.80	17.86	11.83	14.89	17.99	21.05	14.24	16.26	11.27	13.29	17.43	19.45
	05	14.83	18.04	11.86	15.07	19.48	21.23	14.13	16.04	11.16	13.07	17.32	19.23
	22	14.47	16.89	11.50	13.92	17.66	20.08	14.19	15.89	11.22	12.92	17.38	19.08
	35	14.73	18.20	11.76	15.23	17.68	21.39	13.82	14.95	10.85	11.98	17.01	18.14
	80	18.30	21.90	15.30	18.90	21.50	28.39	13.80	14.90	10.80	11.90	17.00	18.10
	98	14.70	17.46	11.73	14.49	17.89	20.65	13.86	15.06	10.89	12.09	17.05	18.25
13	99	14.87	18.09	11.90	15.12	18.06	21.28	13.89	15.29	10.92	12.32	17.08	18.48
	04	21.04	24.82	15.71	19.49	24.14	27.92	19.80	21.70	14.47	16.37	22.90	24.80
	08	21.42	26.60	16.09	21.27	24.52	29.70	20.30	23.40	14.97	18.07	23.40	26.50
	26	21.79	27.44	16.46	22.11	24.89	30.54	20.05	22.74	14.72	17.41	23.15	25.84
	35	21.22	26.99	15.89	21.66	24.32	30.09	19.68	21.49	14.35	16.16	22.78	24.59
15	98	21.08	25.70	15.75	20.37	24.18	28.80	19.68	21.70	14.35	16.37	22.78	24.80
	05	26.04	31.38	19.54	24.88	29.62	34.96	24.49	27.48	17.99	20.98	28.07	31.06
	15	26.84	34.00	20.34	27.50	30.42	37.58	24.57	27.62	18.07	21.12	28.15	31.20
	18	27.05	35.93	20.55	29.43	30.63	39.51	24.53	28.73	18.03	22.23	28.11	32.31
	19	26.58	34.31	20.08	27.81	30.16	37.89	23.92	26.71	17.42	20.21	27.50	30.29
	35	26.68	35.92	20.18	29.42	30.26	39.50	24.09	26.67	17.59	20.17	27.67	30.25
	97	26.51	33.56	20.01	27.06	30.09	37.14	24.15	27.24	17.65	20.74	27.73	30.82
17	02	32.96	46.30	31.26	44.60	42.06	55.40	25.80	29.80	24.10	28.10	34.90	38.90
	06	29.90	39.50	28.21	37.81	39.00	48.60	25.94	29.90	24.25	28.21	35.04	39.00
	08	28.89	37.62	27.20	35.93	37.99	46.72	26.41	31.38	24.72	29.69	35.51	40.48
	26	29.47	40.26	27.78	38.57	38.57	49.36	25.83	29.86	24.14	28.17	34.93	38.96
	35	29.71	43.26	28.02	41.57	38.81	52.36	25.86	29.51	24.17	27.82	34.96	38.61
	75	35.31	46.60	33.62	44.91	44.41	55.70	26.31	32.60	24.62	30.91	35.41	41.70
	99	29.52	40.08	27.83	38.39	38.62	49.18	25.96	30.12	24.27	28.43	35.06	39.22
19	11	37.77	51.36	31.07	44.66	44.62	58.21	34.36	42.78	27.66	46.43	30.86	49.63
	32	36.98	50.38	30.28	43.68	43.83	57.23	32.50	37.58	25.80	41.23	29.00	44.43
	35	37.29	53.74	30.59	47.04	44.14	44.09	32.67	37.24	25.97	40.89	29.17	44.09
21	11	45.51	65.35	39.31	59.15	53.19	73.03	38.25	47.75	32.05	51.93	35.55	55.43
	16	42.61	57.89	36.41	51.69	50.29	65.57	37.65	45.41	31.45	49.59	34.95	53.09
	35	42.89	63.55	36.69	57.35	50.57	71.23	37.36	43.80	31.16	47.98	34.66	51.48
	39	44.27	64.60	38.07	58.40	51.95	72.28	38.47	48.24	32.27	52.42	35.77	55.92
	41	42.81	60.18	36.61	64.36	50.49	67.86	37.07	43.78	30.87	47.96	34.37	51.46
	48	49.59	49.93	43.39	43.73	55.27	57.61	36.48	43.38	30.28	37.18	44.16	51.06
23	75	54.48	71.38	48.28	65.18	62.16	79.06	36.48	43.38	30.28	37.18	44.16	51.06
	21	50.49	73.74	44.19	67.44	59.23	82.48	43.98	57.36	37.68	62.20	41.58	66.10
	35	48.85	75.00	42.55	68.70	57.59	83.74	41.85	50.00	35.55	54.84	39.45	58.74
	53	48.91	71.10	42.61	64.80	57.65	79.84	41.49	49.90	35.19	54.74	39.09	58.64
	55	49.66	72.73	43.36	66.43	58.40	81.47	41.96	50.73	35.66	55.57	39.56	59.47
25	07	61.89	90.70	55.73	85.10	71.15	99.10	46.41	56.20	40.25	61.26	44.45	65.46
	11	54.48	71.38	48.28	65.18	62.16	79.06	36.48	43.38	42.94	55.94	58.36	71.36
	19	59.76	91.77	53.60	85.61	69.02	101.03	47.22	61.37	41.06	66.43	45.26	70.63
	24	59.26	90.62	53.10	84.46	68.52	99.88	47.62	62.06	41.46	67.12	45.66	71.32
	29	57.58	86.55	51.42	80.39	66.84	95.81	48.59	63.93	42.43	68.99	46.63	73.19
	35	55.37	88.20	49.21	82.04	64.63	97.46	46.41	56.20	40.25	61.26	44.45	65.46
	37	57.57	89.86	51.41	82.04	66.83	90.06	46.10	61.00	39.94	60.50	55.36	61.20
	44	52.80	67.61	46.53	65.39	62.05	83.39	44.40	59.22	38.14	57.00	53.66	75.00
	43	57.62	88.30	51.46	82.14	66.88	97.56	48.20	63.50	42.04	68.56	46.24	72.76
	46	59.92	83.76	53.76	77.60	69.18	93.02	45.28	55.44	39.12	60.50	43.32	64.70
	61	54.67	81.42	48.51	75.26	63.93	90.68	46.13	57.02	39.97	62.08	44.17	66.28
	08	81.00	112.83	74.84	106.67	90.26	122.09	45.00	56.83	38.84	61.69	43.04	66.09
	20	66.02	96.24	59.86	90.08	75.28	105.50	44.45	54.70	38.29	59.76	42.49	63.96
04	58.42	88.27	52.26	82.11	67.68	97.53	49.22	62.83	43.06	67.89	47.26	72.09	

## SOURIAU aluminum backshells

### Ordering information

<b>Basic Series</b>	8D	AB	05	A	17	W	S	02	-
<b>Accessories type</b>									
<b>Type:</b>									
01: Backnut	04: Crimp ring								
02: Cable clamp	05: Band lock								
03: Shrink boot									
<b>Angle:</b>									
A: Straight									
B: 90° (Type 02 only)									
<b>Shell size:</b>									
09, 11, 13, 15, 17, 19, 21, 23, 25									
<b>Finish:</b>									
Z: Black zinc nickel									
W: Olive green cadmium									
F: Nickel									
A: Black anodized									
<b>Self locking option:</b>									
None									
S: Self locking (available for Types 01 & 02 - mandatory for Type 05)									
<b>Cable entry (Type 05 only):</b>									
02, 03 (03 mandatory for shell size 09 & 11)									
<b>Drain hole option:</b>									
None									
D: Drain hole (Type 03 only)									

### Dimensions

#### Aluminum backshell Type 01 - Backnut

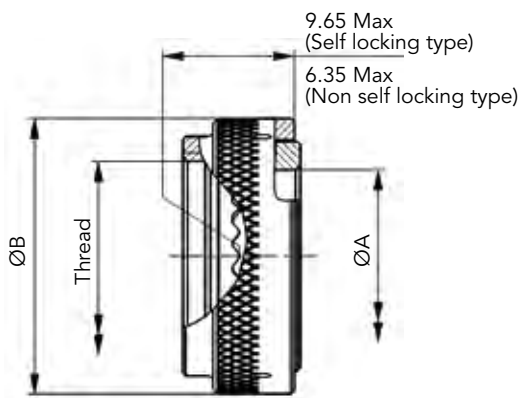

Shell size	ØA Min	ØB Max
09	6.7	17.9
11	9.95	20.9
13	12.85	24.3
15	17.0	27.9
17	19.25	31.3
19	21.7	35.3
21	24.7	38.1
23	27.8	41.5
25	32.0	44.5

Thread: See page 30 for information.

Note: All dimensions are in millimeters (mm)

### Aluminum backshell Type 02 - Cable clamp

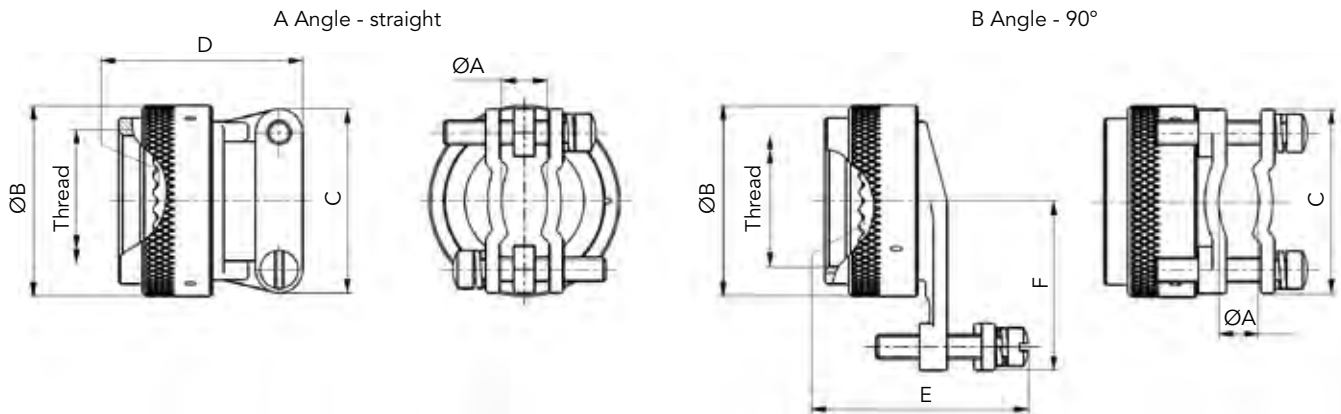

Shell size	ØA		ØB Max	C Max	D Max	E Max	F Max
	Min	Max					
09	2.49	5.94	17.9	21.5	23.1	29.5	20
11	3.89	5.94	20.9	21.5	23.1	29.5	21.5
13	4.83	8.33	24.3	24.5	25.6	31.5	23.5
15	6.60	11.61	27.9	27.5	26.9	35.8	25.5
17	7.19	15.6	31.3	31.5	29.4	40.1	27.5
19	8.26	16.1	35.3	35.5	35.8	40.6	30.5
21	8.71	17.73	38.1	37	38.3	42.7	31.5
23	9.68	20.9	41.5	40.5	42.1	46.2	34.5
25	10.62	21.67	44.5	45	44.7	49	36.5

Thread: See page 30 for information.

### Aluminum backshell Type 03 - Shrink boot

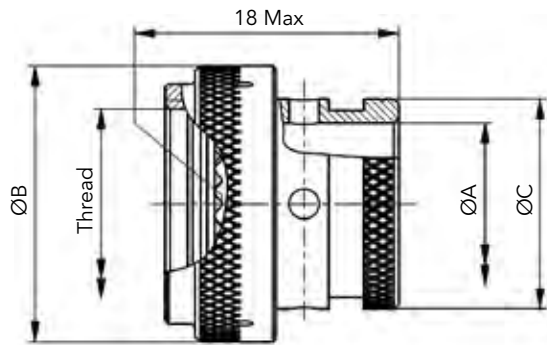

Shell size	ØA Min	ØB Max	C Max
09	6.7	19.0	11.3
11	9.95	21.5	14.9
13	12.85	25.3	17.8
15	16.05	29.1	21.27
17	19.2	31.7	24.3
19	21.5	35.5	26.4
21	24.7	39.3	30.8
23	27.8	41.8	34.1
25	31	46.9	36.6

Thread: See page 30 for information.

### Aluminum backshell Type 04 - Crimp ring

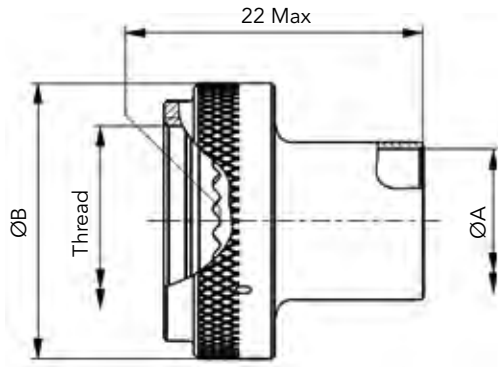

Shell size	ØA Min	ØB Max
09	6	17.9
11	8.2	20.9
13	10.5	24.3
15	13.6	27.9
17	16.9	31.3
19	20	34.3
21	23.2	38.1
23	26.1	41.5
25	28.1	44.4

Thread: See below for information.

### Aluminum backshell Type 05 - Band lock

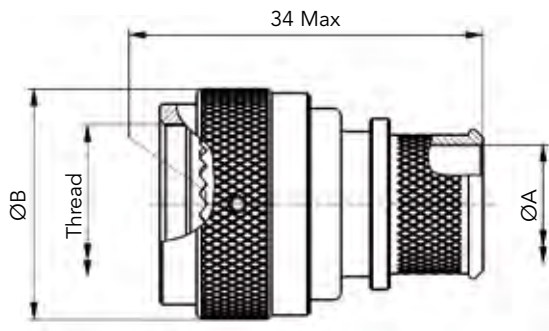

Shell size	ØA Max - Entry size		ØB Max
	02	03	
09	-	6.6	17.9
11	-	8	24.9
13	8	11.2	29.3
15	11.2	14.4	32.4
17	12.8	16	35.6
19	16	19.1	38.4
21	16	20.7	41.6
23	17.6	23.9	44.8
25	19.1	25.5	47.9

Thread: See below for information.

### Recommended installation torque

Shell Size	Installation Torque (Inch-Pounds)
09, 11, 13, 15, 17 & 19	40
21, 23 & 25	80

Note: Torque values are based on 80% of the coupling thread strength specified in SAE-AS85049 standard.

### Thread information

Shell size	UNEF Thread
09	M12x1.0-6H-0.10R
11	M15x1.0-6H-0.10R
13	M18x1.0-6H-0.10R
15	M22x1.0-6H-0.10R
17	M25x1.0-6H-0.10R
19	M28x1.0-6H-0.10R
21	M31x1.0-6H-0.10R
23	M34x1.0-6H-0.10R
25	M37x1.0-6H-0.10R

Note: All dimensions are in millimeters (mm)

## M85049 aluminum backshells

### Backshells - Cable clamp

**Straight cable clamp (Type 38)**

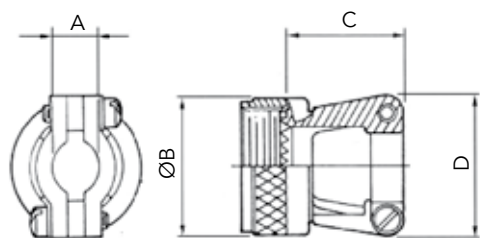

**90° cable clamp (Type 39)**

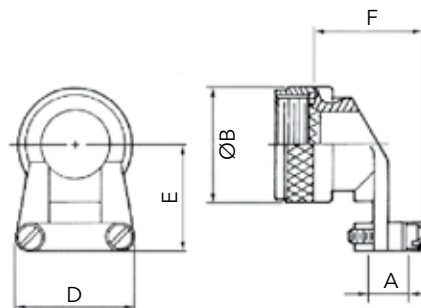

Shell size	A		ØB Max	C Max	D Max	E	F
	Min	Max					
09	2.50	5.90	21.80	23.10	21.60	25.40	25.70
11	3.90	5.90	25.00	23.10	22.90	27.90	25.70
13	4.80	8.30	29.40	25.70	27.90	27.90	30.70
15	6.60	11.60	32.50	26.90	29.20	31.80	32.00
17	7.20	15.60	35.70	29.50	33.00	33.00	35.80
19	8.30	16.10	38.50	35.80	38.10	34.30	38.40
21	8.70	17.70	41.70	38.40	40.60	40.60	42.20
23	9.70	20.90	44.90	42.20	43.20	44.50	44.70
25	10.60	21.70	48.00	44.70	45.70	47.00	48.50

Basic Series

M85049

38

-

11

W

Backshell type:

38: Straight cable clamp

39: 90° cable clamp

Nut type:

- : Without self-locking

S: With self-locking

Shell size:

09, 11, 13, 15, 17, 19, 21, 23, 25

Plating:

Type 38 & 39:

A: Black anodized (500 hours salt spray)

W: Olive drab cadmium over nickel (500 hours salt spray)

Type 38S & 39S:

W: Olive drab cadmium over nickel (500 hours salt spray)

N: Nickel (48 hours salt spray)

Backshells for heat shrink boots

Backshell for heat shrink boots (Type 69)

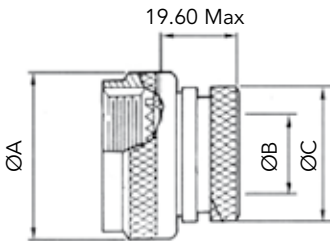

Shell size	ØA Max	ØB Max	ØC Max
09	19.10	6.35	13.55
11	21.60	9.50	15.40
13	25.40	12.70	19.70
15	29.20	15.90	21.30
17	31.80	19.00	24.50
19	35.60	20.60	26.50
21	39.40	23.80	30.90
23	41.90	27.00	34.40
25	47.00	30.20	36.65

Straight backshell for EMI/RFI heat shrink boots (Type 88)

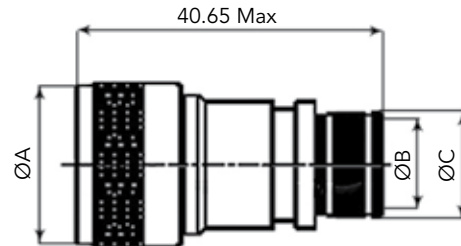

Shell size	ØA Max	ØB <sup>±0.10</sup> Entry size		ØC	
		02	03	02	03
09	21.79	-	6.35	-	10.03
11	24.99	-	7.92	-	11.61
13	29.39	7.92	11.13	11.61	14.81
15	32.49	11.13	14.27	14.81	17.96
17	35.71	12.70	15.88	16.38	19.56
19	38.51	15.88	19.05	19.56	22.73
21	41.71	15.88	20.62	19.56	24.30
23	44.91	17.47	23.83	21.06	27.51
25	47.98	19.05	25.40	22.73	29.08

Basic Series

M85049

69

11

A

D

Backshell type:

69: Backshell for heat shrink boots

88: Straight backshell for EMI/RFI heat shrink boots

Shell size:

09, 11, 13, 15, 17, 19, 21, 23, 25

Plating:

Type 69:

A: Black anodised (500 hours salt spray)

Type 88:

W: Olive drab cadmium

N: Nickel

Option (Type 69 only):

Empty: Without drain hole

D: With drain hole

Entry size (Type 88 only):

02: See table above

03: See table above

Note: All dimensions are in millimeters (mm)



### Backshell for screen termination and cable clamp

#### Backshell for screen termination and cable clamp (Type 19)

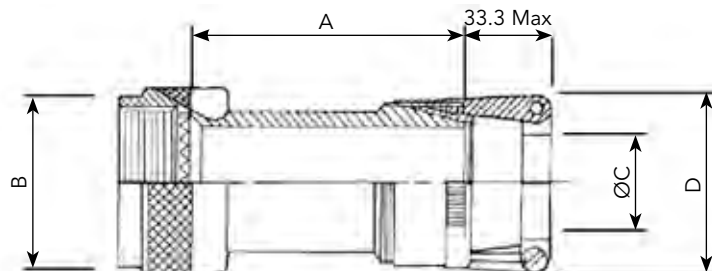

Shell size	A Max	B Max	Clamp indicator base on shell size
09	38.10	19.10	01 - 02
11		21.60	01 - 02 - 03
13		25.40	02 - 03 - 04
15		27.90	02 - 03 - 04 - 05
17		31.80	02 - 03 - 04 - 05 - 06
19		35.60	03 - 04 - 05 - 06 - 07
21		38.10	03 - 04 - 05 - 06 - 07 - 08
23		41.90	03 - 04 - 05 - 06 - 07 - 08
25		44.50	04 - 05 - 06 - 07 - 08 - 10

Clamp size indicator	C		D
	Min	Max	
01	1.60	3.20	20.30
02	3.20	6.35	25.40
03	6.35	9.50	27.90
04	7.90	12.70	30.50
05	11.10	15.90	31.80
06	14.30	19.00	35.60
07	17.45	22.20	38.10
08	20.60	24.40	41.90
09	23.80	28.60	44.50
10	27.00	31.75	48.30

Basic Series	M85049	19	11	W	03
Shell style:	19: Backshell for screen termination and cable clamp				
Shell size:	09, 11, 13, 15, 17, 19, 21, 23, 25				
Plating:	W: Olive drab cadmium N: Nickel				
Clamp size indicator:	See tables above				

#### Band-it

	Flat stainless steel standard band	Pre-coiled stainless steel standard band	Hand banding tool
Part number	8599-9344	8599-9345	8599-9346

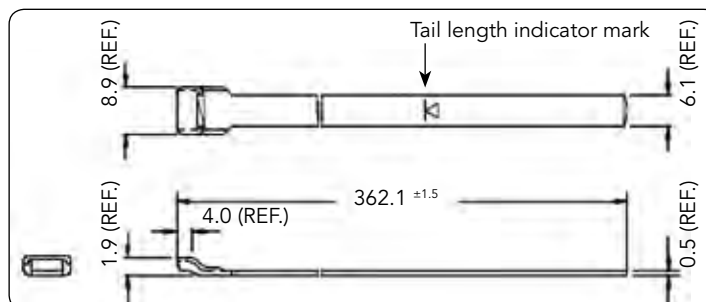

Note: All dimensions are in millimeters (mm)

## Caps

### Souriau part number

Basic Series	8D	AC	5	R	09	W
AC: Aluminum caps						
<b>Caps style:</b>						
5: Plug caps						
0: Receptacle caps						
<b>Accessories</b>						
N: With stainless steel rope and ring						
R: With stainless steel rope and eyelet						
<b>Shell size: 09, 11, 13, 15, 17, 19, 21, 23, 25</b>						
<b>Finish</b>						
W: Olive drab cadmium						
F: Nickel						
Z: Black zinc nickel						
A: Black anodized						

### MIL-DTL-38999 part number

Basic Series	D38999 /	32	W	09	R
<b>Caps style</b>					
32: Plug caps					
33: Receptacle caps					
<b>Finish</b>					
W: Olive drab cadmium					
F: Nickel					
Z: Black zinc nickel					
<b>Shell size: 09, 11, 13, 15, 17, 19, 21, 23, 25</b>					
<b>Accessories</b>					
N: With stainless steel rope and ring					
R: With stainless steel rope and eyelet					

## Dimensions

### Aluminum caps with stainless steel rope

#### For plug

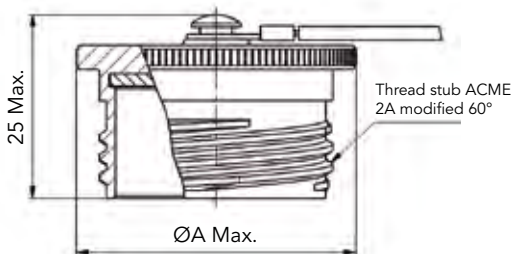

#### For receptacle

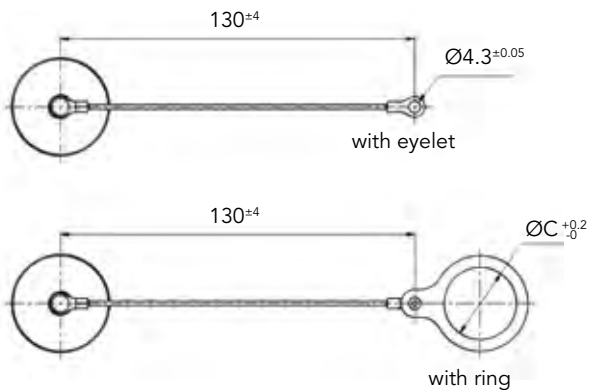
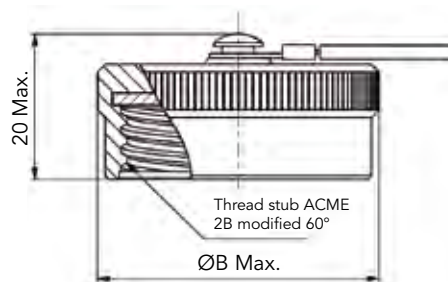

Size	ØA	ØB	ØC for plug	ØC for receptacle	Thread
09	22.6	22.8	15	18.4	0.6250-0.1P-0.3L-TS
11	25.8	26.5	18.4	23.2	0.7500-0.1P-0.3L-TS
13	30	30	23.2	26.5	0.8750-0.1P-0.3L-TS
15	33	31.8	23.2	30.3	1.0000-0.1P-0.3L-TS
17	36.5	36.8	26.5	32.6	1.1875-0.1P-0.3L-TS
19	39.2	38.8	30.3	36.5	1.2500-0.1P-0.3L-TS
21	42.5	41.8	32.6	39.3	1.3750-0.1P-0.3L-TS
23	45.8	44.8	36.5	42.9	1.5000-0.1P-0.3L-TS
25	48.9	48.8	39.3	45	1.6250-0.1P-0.3L-TS

Note: All dimensions are in millimeters (mm)

## Connector part numbers

<b>Basic Series</b>	<b>8D</b>	<b>0</b>	<b>-</b>	<b>11</b>	<b>J</b>	<b>35</b>	<b>P</b>	<b>N</b>			<b>L</b>
<b>Shell style:</b>											
<ul style="list-style-type: none"> <li><b>0:</b> Square flange receptacle</li> <li><b>5:</b> Plug with RFI shielding</li> </ul>											
<b>Type:</b>											
<ul style="list-style-type: none"> <li>- : Connectors with standard crimp contacts.</li> <li><b>L:</b> Receptacle with long PC tail (male and female size #22D, #20).</li> <li><b>C:</b> Receptacle with short PC tail (male and female #22D, #20, #16, #12).</li> <li><b>S:</b> Receptacle with specific PC tail (male et female #22D)</li> <li><b>W:</b> Receptacle with male contacts #22D for wire wrap (3 wraps)</li> <li><b>T:</b> Receptacle with male contacts #20 for wire wrap (2 wraps)</li> <li><b>P:</b> Receptacle with solder cup contacts - see page 69, please consult us</li> </ul>											
<b>Shell size: 09, 11, 13, 15, 17, 19, 21, 23, 25</b>											
<b>Plating:</b>											
<ul style="list-style-type: none"> <li><b>J:</b> Olive drab cadmium</li> <li><b>M:</b> Nickel</li> <li><b>X:</b> Without plating</li> </ul>											
<b>Contact layout:</b> See pages 13 to 19											
<b>Contact type:</b>											
<ul style="list-style-type: none"> <li><b>P:</b> Pin (500 mating/unmating)</li> <li><b>H:</b> Pin (1500 mating/unmating)</li> <li><b>A:</b> Connector supplied less pin contact or with specific contacts (connector marking: A + orientation)</li> <li><b>S:</b> Socket (500 mating/unmating)</li> <li><b>J:</b> Socket (1500 mating/unmating)</li> <li><b>B:</b> Connector supplied less socket contact or with specific contacts (connector marking: B + orientation)</li> </ul>											
<b>Orientation: N, A, B, C, D, E, T, V</b> (see page 75)											
<b>Specification:</b>											
<ul style="list-style-type: none"> <li><b>046:</b> Tinned straight PC tail</li> <li><b>251:</b> Connector provided with power contacts (layouts with contact #8)</li> <li><b>022:</b> Fuel tank</li> <li><b>600:</b> 230V qualified connector (T or V orientation mandatory - Consult us for available layouts)</li> </ul>											
<b>Special custom:</b>											
<ul style="list-style-type: none"> <li><b>None:</b> Standard plastic cap</li> <li><b>M:</b> Antistatic plastic cap</li> </ul>											
<b>L:</b> For P or S contact type only, connectors delivered without contacts, connectors marking P or S plus orientation.											

Note: PC tail contacts without shoulder also available. Please see page 102.

## BACC part numbers

<b>Basic Series:</b>	<b>BACC63CT</b>	<b>13</b>	<b>-</b>	<b>98</b>	<b>P</b>	<b>N</b>	<b>H</b>
<ul style="list-style-type: none"> <li><b>BACC63CT:</b> 8D5*M (composite plug)</li> <li><b>BACC63CU:</b> 8D0*M (composite square flange receptacle)</li> </ul>							
<b>Shell size: 09=A, 11=B, 13=C, 15=D, 17=E, 19=F, 21=G, 23=H, 25=J</b>							
<b>Plating &amp; grounding:</b>							
<ul style="list-style-type: none"> <li>- : Nickel plated, ungrounded</li> <li><b>G:</b> Nickel plated, grounded</li> <li><b>D:</b> Cadmium plated, ungrounded</li> <li><b>C:</b> Cadmium plated, grounded</li> </ul>							
<b>Contact layout:</b> See page 18 for layout according to BACC							
<b>Contact type:</b>							
<ul style="list-style-type: none"> <li><b>P:</b> Pin</li> <li><b>S:</b> Socket</li> </ul>							
<b>Orientation: N, A, B, C, D, E</b> (see page 75)							
<b>Specification:</b>							
<ul style="list-style-type: none"> <li><b>None:</b> With contacts</li> <li><b>H:</b> Without contact &amp; without filler plug</li> </ul>							

## MIL-DTL-38999 part numbers

<b>Basic Series</b>	D38999/	20	M	B	35	P	N	L
<b>Shell style:</b>								
20: Square flange receptacle								
26: Plug with RFI shielding.								
<b>Plating:</b>								
J: Olive drab cadmium								
M: Nickel								
<b>Shell size:</b>								
09=A, 11=B, 13=C, 15=D, 17=E, 19=F, 21=G, 23=H, 25=J								
<b>Contact layout:</b>								
See page 18 for layout according to MIL-DTL-38999								
<b>Contact type:</b>								
P: Pin (500 mating/unmating)								
H: Pin (1500 mating/unmating)								
A: Connector supplied less pin contact or with specific contacts (connector marking: A + orientation)								
S: Socket (500 mating/unmating)								
J: Socket (1500 mating/unmating)								
B: Connector supplied less socket contact or with specific contacts (connector marking: B + orientation)								
<b>Orientation:</b>								
N, A, B, C, D, E (see page 75)								
L: For P or S contact type only, connector delivered without contacts, connector marking P or S (without L)								

Note: To place an order of MIL connectors delivered without MIL removable crimp contacts and keep P or S plus orientation marking, it must be specified clearly on the order (by adding a suffix L at the end of the P/N or specified in comment).  
Delivered with MIL contacts mandatory.

## EN3645 part numbers

<b>Basic Series</b>	EN3645	J	6	G	N	35	B	N
<b>Plating:</b>								
J: Olive drab cadmium								
M: Nickel								
<b>Shell style:</b>								
0: Square flange receptacle								
6: Plug								
<b>Shell size:</b>								
09=A, 11=B, 13=C, 15=D, 17=E, 19=F, 21=G, 23=H, 25=J								
<b>Grounding:</b>								
N: Standard insert not grounded								
<b>Contact layout:</b>								
See page 18 for layout according to EN3645								
<b>Contact type:</b>								
A: Connector supplied less pin contact								
B: Connector supplied less socket contact								
F: Socket								
M: Pin								
<b>Orientation:</b>								
N, A, B, C, D, E (see page 75)								

## Dimensions

Receptacle type 0									
Shell size	A Max	B Max	C Max	D Thread	E±0.3	F	G	H±0.2	J±0.2
09 (A)	19.65	11.96	3.65	M12 x 1-6g	23.8	18.26	15.09	3.25	5.49
11 (B)				M15 x 1-6g	26.2	20.62	18.26		4.93
13 (C)				M18 x 1-6g	28.6	23.01	20.62		4.39
15 (D)				M22 x 1-6g	31	24.61	23.01		4.39
17 (E)				M25 x 1-6g	33.3	26.97	24.61		4.93
19 (F)	18.85	12.76	3.7	M28 x 1-6g	36.5	29.36	26.97	3.91	4.93
21 (G)			4.35	M31 x 1-6g	39.7	31.75	29.36		4.93
23 (H)			4.4	M34 x 1-6g	42.9	34.93	31.75		6.15
25 (J)				M37 x 1-6g	46	38.1	34.93		6.15

Plug type 5			
Shell size	A Max	Thread	ØB Max
09 (A)	31.00	M12 x 1-6g	21.80
11 (B)		M15 x 1-6g	25.00
13 (C)		M18 x 1-6g	29.40
15 (D)		M22 x 1-6g	32.50
17 (E)		M25 x 1-6g	35.70
19 (F)		M28 x 1-6g	38.50
21 (G)		M31 x 1-6g	41.70
23 (H)		M34 x 1-6g	44.90
25 (J)		M37 x 1-6g	48.00

Mated connectors		
Shell size	A Max	B Max
09 (A)	37.00	52.30
11 (B)		
13 (C)		
15 (D)		
17 (E)		
19 (F)	36.00	51.30
21 (G)		
23 (H)		
25 (J)		

Note: All dimensions are in millimeters (mm)

Receptacle with straight PC tail contacts

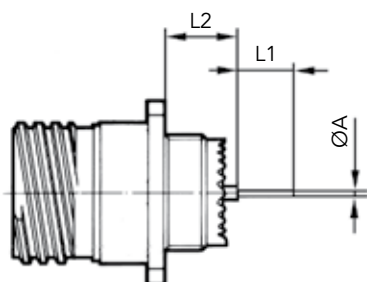

	Shell size			09 (A)	11 (B)	13 (C)	15 (C)	17 (E)	19 (F)	21 (G)	23 (H)	25 (J)
	Contact size	Contact type	PC tail type									
A	#22D	M & F	L & C					0.70				
	#22D	M & F	S					0.50				
	#20	M & F	C					0.70				
	#16	M & F	C					1.15				
L1	#22D	M & F	L					8.50				
	#22D	M & F	C					4.00				
	#22D	M & F	S					5.00				
	#20	M & F	C					5.00				
	#16	M & F	C					5.00				
L2	Min	#22D	M	L & C			9.48				9.59	
	Max	#22D	M	L & C			10.38				10.48	
	Min	#22D	F	L & C			9.15				9.26	
	Max	#22D	F	L & C			10.38				10.48	
	Min	#22D	M	S			9.65				9.76	
	Max	#22D	M	S			10.55				10.65	
	Min	#22D	F	S			9.32				9.42	
	Max	#22D	F	S			10.55				10.65	
	Min	#20	M	C			9.65				9.76	
	Max	#20	M	C			10.55				10.65	
	Min	#20	F	C			9.65				9.76	
	Max	#20	F	C			10.55				10.65	
	Min	#16	M	C			9.65				9.76	
	Max	#16	M	C			10.55				10.65	
	Min	#16	F	C			9.65				9.76	
	Max	#16	F	C			10.55				10.65	

M: Male contact    F: Female contact    L: Long PC tail    C: Short PC tail    S: Specific PC tail

Note: All dimensions are in millimeters (mm)

**Connectors weight** - in gram ( $\pm 15\%$ )

Shell size & Layout		With contacts				Without contacts			
		Plug (type 5)		Receptacle (type 0)		Plug (type 5)		Receptacle (type 0)	
		Male	Female	Male	Female	Male	Female	Male	Female
09	35	8.5	10.1	7.8	9.4	8.1	8.6	7.4	7.9
	98	8.5	9.8	7.8	9.1	8.1	8.6	7.4	7.9
11	01	12.8	15.7	10.4	13.3	12.1	14.1	9.7	11.7
	02	11.5	14.1	09.3	11.8	10.9	12.5	8.7	10.3
	04	12.6	15.7	10.2	13.3	12.0	14.1	9.7	11.7
	05	12.6	15.8	10.2	13.4	11.9	13.8	9.5	11.5
	22	11.4	13.8	9.1	11.6	11.1	12.8	8.8	10.6
	35	12.5	16.0	10.1	13.6	11.6	12.8	9.2	10.4
	80	15.2	18.6	13.4	10.4	10.7	11.6	8.9	9.4
	98	12.5	15.3	10.1	12.9	11.7	12.8	9.3	10.5
	99	11.8	15.0	9.6	12.8	10.8	12.2	8.6	10.0
13	04	17.2	20.9	13.7	17.5	15.6	17.9	12.4	14.3
	08	17.6	22.8	14.1	19.2	16.5	19.6	12.9	16.1
	26	17.9	23.6	14.4	20.1	16.2	18.9	12.7	15.4
	35	17.4	23.1	13.8	19.6	15.8	17.6	12.3	14.1
	98	17.2	21.8	13.7	18.3	15.8	17.9	12.3	14.3
15	05	21.4	26.7	16.6	21.9	19.8	22.8	15.0	18.0
	15	22.2	29.3	17.4	24.5	19.9	23.0	15.1	18.1
	18	22.4	31.3	17.6	26.5	19.9	24.0	15.0	19.2
	19	22.0	29.6	17.1	24.8	19.2	22.0	14.5	17.2
	35	22.0	31.3	17.2	26.5	19.4	22.0	14.6	17.2
	97	21.8	28.9	17.1	24.1	19.4	22.6	14.7	17.8
17	02	26.5	38.8	25.2	37.6	19.3	22.3	18.1	21.1
	06	25.9	35.5	23.2	32.8	21.9	25.9	19.2	23.2
	08	24.9	33.6	22.2	30.1	22.4	27.4	19.7	24.7
	26	25.5	36.3	22.8	33.6	21.8	25.9	19.2	23.1
	35	25.7	39.3	23.0	36.6	21.9	25.5	19.2	22.8
	75	31.3	42.6	28.6	39.9	22.3	28.6	19.6	25.9
19	99	25.5	36.1	22.8	33.4	22.0	26.1	19.3	23.4
	11	32.1	45.7	26.1	39.7	28.7	37.1	22.7	31.1
	32	31.3	44.7	25.3	38.7	26.8	31.9	20.8	25.9
21	35	31.6	48.1	25.6	42.0	27.1	31.6	21.0	25.6
	11	38.0	57.9	32.8	52.6	30.8	40.3	25.5	35.1
	16	35.1	50.4	29.9	45.2	30.2	37.9	24.9	32.7
	35	35.4	56.1	30.1	50.8	29.9	36.3	24.6	31.1
	39	36.8	57.1	31.5	51.9	31.0	40.8	25.7	35.5
	41	35.3	52.7	30.1	47.5	29.6	36.3	24.3	31.0
	48	42.4	62.4	37.7	57.7	29.3	36.2	24.6	31.5
23	75	47.3	64.2	42.6	59.50	29.3	36.2	24.6	31.5
	21	43.1	66.3	38.0	61.2	36.5	49.9	31.5	44.8
	35	41.4	67.5	36.3	62.5	34.4	42.5	29.3	37.5
	53	41.5	63.6	36.4	58.6	34.1	42.4	29.0	37.4
25	55	42.2	65.3	42.2	60.2	34.5	43.3	29.4	38.2
	07	53.6	90.05	49.0	84.8	37.8	51.8	33.2	46.6
	11	59.1	81.6	54.5	77.0	40.8	53.8	36.2	49.2
	19	51.7	83.7	46.6	78.6	39.2	53.3	34.0	48.2
	24	51.2	82.5	46.1	77.4	39.6	54.0	34.4	48.9
	29	49.5	78.5	44.4	73.4	40.5	55.9	35.4	50.7
	35	47.3	80.1	42.2	75.0	38.4	48.1	33.2	43.0
	37	49.3	80.4	45.5	76.2	37.8	51.5	34.0	47.3
	44	69.6	93.7	65.0	94.6	36.1	45.8	31.5	46.7
	43	49.6	80.2	44.4	75.1	40.1	55.4	35.0	50.3
	46	51.9	75.7	46.7	70.1	37.2	47.4	32.1	42.2
	61	46.6	73.4	41.5	68.2	38.1	48.9	32.9	43.8
	08	72.9	104.8	67.8	99.6	36.9	48.8	31.8	43.6
20	57.9	88.2	52.8	83.0	36.4	46.6	31.3	41.5	
04	50.4	80.2	45.3	75.0	41.2	54.8	36.1	49.6	

**Backshells**

**Straight backshell for EMI/RFI heat shrink boots (Type 88)**

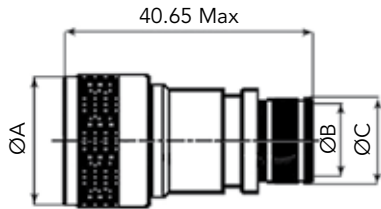

**Straight cable clamp (Type 91)**

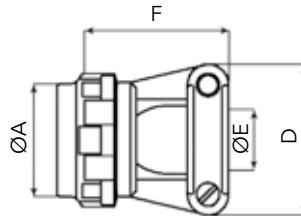

**90° cable clamp (Type 92)**

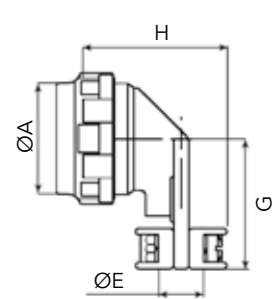

Shell size	ØA Max	ØB <sup>±0.10</sup> Entry size		ØC Entry size		D Max	E Max	F Max	G	H
		02	03	02	03					
09	21.80	N/A	6.35	N/A	10.03	24.90	5.55	21.25	22.20	26.95
11	25.00	N/A	7.92	N/A	11.61	26.00	6.70	24.30	23.80	27.95
13	29.40	7.92	11.13	11.61	14.81	30.50	8.75	27.95	26.20	30.00
15	32.50	11.13	14.27	14.81	17.96	33.00	11.70	27.95	28.60	33.00
17	35.70	12.70	15.88	16.38	19.56	36.10	13.85	31.25	33.30	35.05
19	38.50	15.88	19.05	19.56	22.73	38.60	15.60	35.80	34.95	36.85
21	41.70	15.88	20.62	19.56	24.30	41.65	17.75	38.35	38.10	39.15
23	44.90	17.47	23.83	21.06	27.51	45.00	19.80	42.15	41.30	41.15
25	48.00	19.05	25.40	22.73	29.08	48.00	21.60	44.70	44.45	42.95

<b>Basic Series</b>	<b>M85049</b>	<b>91</b>	<b>11</b>	<b>M</b>
<b>Backshell type:</b>				
88: Straight backshell for EMI/RFI heat shrink boots				
91: Straight cable clamp				
92: 90° cable clamp				
<b>Shell size:</b>				
09, 11, 13, 15, 17, 19, 21, 23, 25				
<b>Plating:</b>				
J: Olive drab cadmium over electroless nickel				
M: Electroless nickel				
T: Without plating (Type 91 & 92 only)				
<b>Entry size (Type 88 only):</b>				
02: See table above				
03: See table above				

Note: All dimensions are in millimeters (mm)



## Connector part numbers

<b>Basic Series</b>	<b>8D</b>	<b>0</b>	<b>-</b>	<b>11</b>	<b>K</b>	<b>35</b>	<b>P</b>	<b>N</b>		<b>L</b>
<b>Locking type:</b>										
<b>None:</b> Receptacle or plug with standard locking										
<b>V:</b> Plug with reinforced locking										
<b>Shell style:</b>										
<b>0:</b> Square flange receptacle										
<b>7:</b> Jam nut receptacle										
<b>5:</b> Plug with RFI shielding										
<b>Type:</b>										
<b>- :</b> Connectors with standard crimp contacts										
<b>L:</b> Receptacle with long PC tail (male and female size #22D, #20)										
<b>C:</b> Receptacle with short PC tail (male and female #22D, #20, #16, #12)										
<b>S:</b> Receptacle with specific PC tail (male et female #22D)										
<b>W:</b> Receptacle with male contacts #22D for wire wrap (3 wraps)										
<b>T:</b> Receptacle with male contacts #20 for wire wrap (2 wraps)										
<b>P:</b> Receptacle with solder cup contacts - see page 69, please consult us										
<b>Shell size: 09, 11, 13, 15, 17, 19, 21, 23, 25</b>										
<b>Plating:</b>										
<b>K:</b> Passivated										
<b>S:</b> Nickel (locking type V, please consult us)										
<b>Contact layout:</b> See pages 13 to 19										
<b>Contact type:</b>										
<b>P:</b> Pin										
<b>A:</b> Connector supplied less pin contact or with specific contacts (connector marking: A + orientation)										
<b>S:</b> Socket										
<b>B:</b> Connector supplied less socket contact or with specific contacts (connector marking: B + orientation)										
<b>Orientation: N, A, B, C, D, E, T, V</b> (see page 75)										
<b>Specification:</b>										
<b>046:</b> Tinned straight PC tail										
<b>251:</b> Connector provided with power contacts (layouts with contact #8)										
<b>022:</b> Fuel tank										
<b>600:</b> 230V qualified connector (T or V orientation mandatory - Consult us for available layouts)										
<b>Special custom:</b>										
<b>None:</b> Standard plastic cap										
<b>M:</b> Antistatic plastic cap										
<b>L:</b> For P or S contact type only, connectors delivered without contacts, connectors marking P or S plus orientation.										

Note: PC tail contacts without shoulder also available. Please see page 102.

## BACC part numbers

<b>Basic Series:</b>	<b>BACC63DB</b>	<b>13</b>	<b>-</b>	<b>98</b>	<b>P</b>	<b>N</b>	<b>H</b>
<b>BACC63DB:</b> 8D5*K (stainless steel plug)							
<b>BACC63DC:</b> 8D0*K (stainless steel square flange receptacle)							
<b>Shell size:</b>							
<b>09=A, 11=B, 13=C, 15=D, 17=E, 19=F, 21=G, 23=H, 25=J</b>							
<b>- :</b> Separator (mandatory)							
<b>Contact layout:</b>							
See page 18 for layout according to BACC							
<b>Contact type:</b>							
<b>P:</b> Pin							
<b>S:</b> Socket							
<b>Orientation:</b>							
<b>N, A, B, C, D, E</b> (see page 75)							
<b>Specification:</b>							
<b>None:</b> With contacts							
<b>H:</b> Without contact & without filler plug							

## MIL-DTL-38999 part numbers

<b>Basic Series</b>	D38999/	20	K	B	35	P	N	L
<b>Shell style:</b>								
20: Square flange receptacle								
24: Jam nut receptacle								
26: Plug with RFI shielding								
<b>Plating:</b>								
K: Passivated								
S: Nickel								
<b>Shell size:</b>								
09=A, 11=B, 13=C, 15=D, 17=E, 19=F, 21=G, 23=H, 25=J								
<b>Contact layout:</b>								
See page 18 for layout according to MIL-DTL-38999								
<b>Contact type:</b>								
P: Pin								
A: Connector supplied less pin contact or with specific contacts (connector marking: A + orientation)								
S: Socket								
B: Connector supplied less socket contact or with specific contacts (connector marking: B + orientation)								
<b>Orientation:</b>								
N, A, B, C, D, E (see page 75)								
L: For P or S contact type only, connector delivered without contacts, connector marking P or S (without L)								

Note: To place an order of MIL connectors delivered without MIL removable crimp contacts and keep P or S plus orientation marking, it must be specify clearly on the order (by adding a suffix L at the end of the P/N or specified in comment).  
Delivered with MIL contacts mandatory.

## EN3645 part numbers

<b>Basic Series</b>	EN3645	K	6	G	N	35	B	N
<b>Plating:</b>								
K: Stainless steel passivated								
<b>Shell style:</b>								
0: Square flange receptacle								
6: Plug								
7: Jam nut receptacle								
<b>Shell size:</b>								
09=A, 11=B, 13=C, 15=D, 17=E, 19=F, 21=G, 23=H, 25=J								
<b>Grounding:</b>								
N: Standard insert not grounded								
<b>Contact layout:</b>								
See page 18 for layout according to EN3645								
<b>Contact type:</b>								
A: Connector supplied less pin contact								
B: Connector supplied less socket contact								
F: Socket								
M: Pin								
<b>Orientation:</b>								
N, A, B, C, D, E (see page 75)								

## Dimensions

### Receptacle type 0 (8D) or type 20 (D38999)

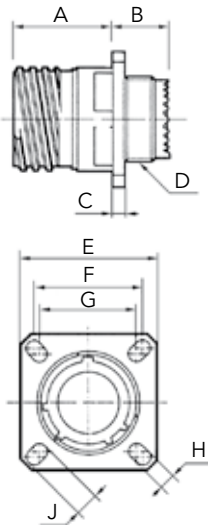

Shell size	A Max	B Max	C Max	D Thread	E <sup>±0.3</sup>	F	G	H <sup>±0.2</sup>	J <sup>±0.2</sup>
09 (A)	20.2	11.4	2.5	M12 x 1-6g	23.8	18.26	15.09	3.25	5.49
11 (B)				M15 x 1-6g	26.2	20.62	18.26		4.93
13 (C)				M18 x 1-6g	28.6	23.01	20.62		4.4
15 (D)				M22 x 1-6g	31	24.61	23.01		4.93
17 (E)				M25 x 1-6g	33.3	26.97	24.61		
19 (F)				M28 x 1-6g	36.5	29.36	26.97		
21 (G)	19.8	11.8	3.2	M31 x 1-6g	39.7	31.75	29.36	3.91	6.15
23 (H)		11.4		M34 x 1-6g	42.9	34.93	31.75		
25 (J)				M37 x 1-6g	46	38.1	34.93		

### Receptacle type 7 (8D) or type 24 (D38999)

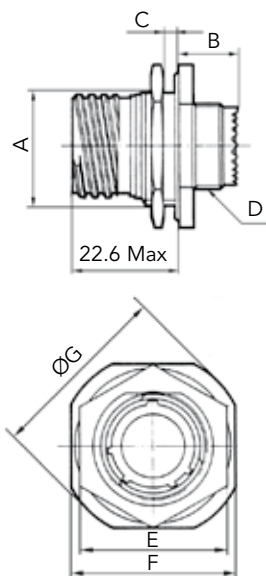

Shell size	A <sup>±0.15</sup>	B Max	C Max	D Thread	E Max	F <sup>±0.4</sup>	ØG Max
09 (A)	16.53	9.9	3.2	M12 x 1-6g	23	27	30.5
11 (B)	19.07			M15 x 1-6g	26	31.8	35.2
13 (C)	23.82			M18 x 1-6g	31	34.9	38.4
15 (D)	26.97			M22 x 1-6g	34	38.1	41.6
17 (E)	30.15			M25 x 1-6g	37	41.3	44.8
19 (F)	33.32			M28 x 1-6g	41	46	49.5
21 (G)	36.50			M31 x 1-6g	46	49.2	52.7
23 (H)	39.67			M34 x 1-6g	47	52.4	55.9
25 (J)	42.85			M37 x 1-6g	51.23	55.6	59

#### Recommended coupling torque on panel for jam nut receptacle (type 7)

Shell	09 (A)	11 (B)	13 (C)	15 (D)	17 (E)	19 (F)	21 (G)	23 (H)	25 (J)
Coupling torque (±0.5 N.m)	4	5	7	8	9	10	12	13	14

Note: All dimensions are in millimeters (mm)

**Plug type 5 (8D & 8DV) or type 26 (D38999)**

8D type 5 & D38999 type 26

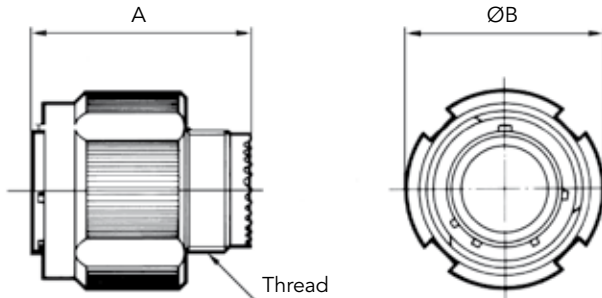

8DV type 5 - reinforced locking

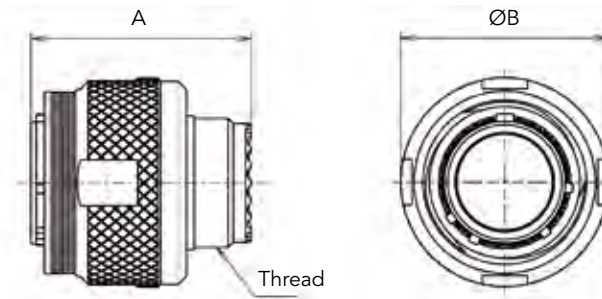

Shell size	A Max	Thread	ØB Max
09 (A)	31.00	M12 x 1-6g	21.80
11 (B)		M15 x 1-6g	25.00
13 (C)		M18 x 1-6g	29.40
15 (D)		M22 x 1-6g	32.50
17 (E)		M25 x 1-6g	35.70
19 (F)		M28 x 1-6g	38.50
21 (G)		M31 x 1-6g	41.70
23 (H)		M34 x 1-6g	44.90
25 (J)		M37 x 1-6g	48.00

**Mated connectors dimensions**

Type 0 with plug

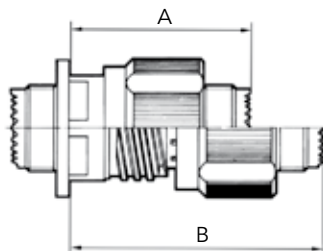

Type 7 with plug

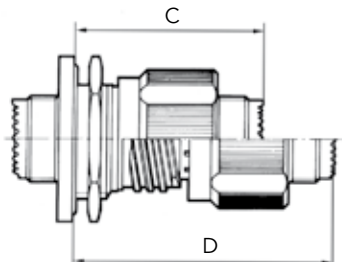

Shell size	A Max	B Max	C Max	D Max
09 (A)	37.00	52.30	38.30	53.60
11 (B)			38.50	53.80
13 (C)				
15 (D)				
17 (E)	36.00	51.30	38.50	53.80
19 (F)				
21 (G)	36.00	51.30	38.50	53.80
23 (H)				
25 (J)				

Note: All dimensions are in millimeters (mm)

Receptacle with straight PC tail contacts



		Shell size			09 (A)	11 (B)	13 (C)	15 (C)	17 (E)	19 (F)	21 (G)	23 (H)	25 (J)
		Contact size	Contact type	PC tail type									
A		#22D	M & F	L & C					0.70				
		#22D	M & F	S					0.50				
		#20	M & F	C					0.70				
		#16	M & F	C					1.12 <sup>±0.03</sup>				
L1	Min	#22D	M	L & C	10.52					10.34			
	Max	#22D	M	L & C	11.46					11.28			
	Min	#22D	F	L & C	10.19					10.01			
	Max	#22D	F	L & C	11.46					11.28			
	Min	#22D	M	S	10.19					10.01			
	Max	#22D	M	S	11.46					11.28			
	Min	#22D	F	S	10.69					10.51			
	Max	#22D	F	S	11.63					11.45			
	Min	#20	M	C	10.36					10.18			
	Max	#20	M	C	11.63					11.45			
	Min	#20	F	C	10.69					10.51			
	Max	#20	F	C	11.63					11.45			
	Min	#16	M	C	10.69					10.51			
	Max	#16	M	C	11.63					11.45			
	Min	#16	F	C	10.69					10.51			
	Max	#16	F	C	11.63					11.45			
L2		#22D	M & F	L					8.50				
		#22D	M & F	C					4.00				
		#22D	M & F	S					5.10				
		#20	M & F	C					5.10				
		#16	M & F	C					5 <sup>±0.1</sup>				
L3	Min	#22D	M	L & C			9.48					9.59	
	Max	#22D	M	L & C			10.58					10.69	
	Min	#22D	F	L & C			9.15					9.26	
	Max	#22D	F	L & C			10.58					10.69	
	Min	#22D	M	S			9.65					9.76	
	Max	#22D	M	S			10.75					10.86	
	Min	#22D	F	S			9.15					9.26	
	Max	#22D	F	S			10.75					10.86	
	Min	#20	M	C			9.65					9.76	
	Max	#20	M	C			10.75					10.86	
	Min	#20	F	C			9.65					9.76	
	Max	#20	F	C			10.75					10.86	
	Min	#16	M	C			9.64					9.75	
	Max	#16	M	C			10.75					10.86	
	Min	#16	F	C			9.64					9.75	
	Max	#16	F	C			10.75					10.86	

M: Male contact    F: Female contact    L: Long PC tail    C: Short PC tail    S: Specific PC tail

Note: All dimensions are in millimeters (mm)

**Connectors weight** - in gram (±15%)

Shell size & Layout		With contacts								Without contacts							
		Plug 8D (type 5)		Plug 8DV (type 5)		Recep. (type 0)		Recep. (type 7)		Plug 8D (type 5)		Plug 8DV (type 5)		Recep. (type 0)		Recep. (type 7)	
		Male	Female	Male	Female	Male	Female	Male	Female	Male	Female	Male	Female	Male	Female	Male	Female
09	35	30.63	32.21	32.53	34.11	23.93	25.51	33.93	35.51	30.21	30.71	32.11	32.61	23.51	24.01	33.51	34.01
	98	30.63	31.93	32.53	33.83	23.93	25.23	33.93	35.23	30.21	30.73	32.11	32.63	23.51	24.03	33.51	34.03
11	01	38.13	41.07	41.53	44.47	29.53	32.47	42.43	45.37	37.47	39.47	40.87	42.87	28.87	30.87	41.77	43.77
	02	37.76	40.30	41.16	43.70	39.36	30.12	46.98	49.52	37.14	38.74	40.54	42.14	28.56	30.16	46.36	47.96
	04	37.95	41.01	41.35	44.41	29.35	32.41	42.25	45.31	37.39	39.41	40.79	42.81	28.79	30.81	41.69	43.71
	05	37.98	41.19	41.38	44.59	29.38	32.59	42.04	45.49	37.28	39.19	40.68	42.59	28.68	30.59	41.58	43.49
	22	37.48	39.54	40.88	42.94	28.90	30.86	46.70	48.76	37.34	39.04	40.74	42.44	28.76	30.36	46.56	48.26
	35	37.88	41.35	41.28	44.75	29.28	32.75	41.94	45.65	36.97	38.10	40.37	41.50	28.37	29.50	41.27	42.40
	80	38.12	44.84	41.52	48.24	29.73	36.26	47.78	54.06	34.86	37.84	38.26	41.24	26.45	29.26	44.51	47.06
	98	37.85	40.61	41.25	44.01	29.25	32.01	42.15	44.91	37.01	38.21	40.41	41.61	28.41	29.61	41.31	42.51
	99	38.02	41.24	41.42	44.64	29.44	32.66	47.24	50.46	37.04	38.44	40.44	41.84	28.46	29.86	46.26	47.66
13	04	53.34	57.12	56.64	60.42	37.94	41.72	56.24	60.02	52.10	54.00	55.40	57.30	36.70	38.60	55.00	56.90
	08	53.72	58.90	57.02	62.20	38.32	43.50	56.62	61.80	52.60	55.70	55.90	59.00	37.20	40.30	55.50	58.60
	26	54.09	59.74	57.39	63.04	38.69	44.34	56.99	62.64	52.35	55.04	55.65	58.34	36.95	39.64	55.25	57.94
	35	53.52	59.29	56.82	62.59	38.12	43.89	56.42	62.19	51.98	53.79	55.28	57.09	36.58	38.39	54.88	56.69
15	98	53.38	58.00	56.68	61.30	37.98	42.60	56.28	60.90	51.98	54.00	55.28	57.30	36.58	38.60	54.88	56.90
	05	64.49	69.83	68.49	73.83	45.69	51.03	67.59	72.93	62.94	65.93	66.94	69.93	44.14	47.13	66.04	69.03
	15	65.29	72.45	69.29	76.45	46.49	53.65	68.39	75.55	63.02	66.07	67.02	70.07	44.22	47.27	66.12	69.17
	18	65.50	74.38	69.50	78.38	46.70	55.58	68.60	77.48	62.98	67.18	66.98	71.18	44.18	48.38	66.08	70.28
	19	65.03	72.76	69.03	76.76	46.23	53.96	68.13	75.86	62.37	65.16	66.37	69.16	43.57	46.36	65.47	68.26
	35	65.13	74.37	69.13	78.37	46.33	55.57	68.23	77.47	62.54	65.12	66.54	69.12	43.74	46.32	65.64	68.22
17	97	64.96	72.01	68.96	76.01	46.16	53.21	68.06	75.11	62.60	65.69	66.60	69.69	43.80	46.89	65.70	68.79
	02	77.80	92.64	82.70	97.54	72.89	87.73	104.09	118.95	74.53	86.09	79.43	90.99	69.62	81.18	100.82	112.38
	06	69.07	78.67	73.97	83.57	64.17	73.77	87.27	96.87	65.11	69.07	70.01	73.97	60.21	64.17	83.31	87.27
	08	68.06	76.79	72.96	81.69	63.16	71.89	86.26	94.99	65.58	70.55	70.48	75.45	60.68	65.65	83.78	88.75
	26	68.64	79.43	73.54	84.33	63.74	74.53	86.84	97.63	65.00	69.03	69.90	73.93	60.10	64.13	83.20	87.23
	35	68.88	82.43	73.78	87.33	63.98	77.53	87.08	100.63	65.03	68.68	69.93	73.58	60.13	63.78	83.23	86.88
19	75	74.48	85.77	79.38	90.67	69.58	80.87	92.68	103.97	65.48	71.77	70.38	76.67	60.58	66.87	83.68	89.97
	99	68.69	79.25	73.59	84.15	63.79	74.35	86.89	97.45	65.13	69.29	70.03	74.19	60.23	64.39	83.33	87.49
	11	87.04	100.63	87.99	101.58	67.69	81.28	97.59	111.18	83.63	92.05	84.58	93.00	64.28	73.45	94.18	103.35
	32	86.25	99.65	87.20	100.60	66.90	80.30	96.80	110.20	81.77	86.85	82.72	87.80	62.42	67.50	92.32	97.40
	35	86.56	103.01	87.51	103.96	67.21	83.66	97.11	113.56	81.94	86.51	82.89	87.46	62.59	67.16	92.49	97.06
21	11	99.71	119.55	101.71	121.55	81.81	101.65	111.81	131.65	92.45	101.95	94.45	103.95	74.55	84.05	104.55	114.05
	16	96.81	112.09	98.81	114.09	78.91	94.19	108.91	124.19	91.85	99.61	93.85	101.61	73.95	81.71	103.95	111.71
	35	97.09	117.75	99.09	119.75	79.19	99.85	109.19	129.85	91.56	98.00	93.56	100.00	73.66	80.10	103.66	110.10
	39	98.47	118.80	100.47	120.8	80.57	100.90	110.57	130.90	92.67	102.44	94.67	104.44	74.77	84.54	104.77	114.54
	41	97.01	114.38	99.01	116.38	79.11	126.48	109.11	126.48	91.27	97.98	93.27	99.98	73.37	80.08	103.37	80.08
	48	103.84	123.82	105.84	125.82	85.93	105.91	126.02	146.02	90.72	97.62	92.72	99.62	72.81	79.71	112.92	119.82
	75	108.72	125.62	110.72	127.62	90.81	107.71	130.92	147.82	90.72	97.62	92.72	99.62	72.81	79.71	112.92	119.82
23	21	108.81	132.06	118.01	141.26	90.61	113.86	122.81	146.06	102.30	115.68	111.5	124.88	84.10	97.48	116.30	129.68
	35	107.17	133.32	116.37	142.52	88.97	115.12	121.17	147.32	100.17	108.32	109.37	117.52	81.97	90.12	114.17	122.32
	53	107.23	129.42	116.43	138.62	89.03	111.22	121.23	143.42	99.81	108.22	109.01	117.42	81.61	90.02	113.81	122.22
	55	107.98	131.05	117.18	140.25	89.78	112.85	121.98	145.05	100.28	109.05	109.48	118.25	82.08	90.85	114.28	123.05
25	07	133.3	157.7	141.50	165.90	115.50	172.25	160.06	172.25	108.51	119.45	116.71	127.65	90.71	101.65	135.27	101.65
	11	132.31	152.31	140.51	160.51	114.51	134.51	159.71	179.07	111.51	124.51	119.71	132.71	93.71	106.71	138.91	151.27
	19	122.14	154.15	130.34	162.35	104.34	136.35	136.74	168.75	109.60	123.75	117.80	131.95	91.80	105.95	124.20	138.35
	24	121.64	153.00	129.84	161.20	103.84	135.20	136.24	167.60	110.00	124.44	118.20	132.64	92.20	106.64	124.60	139.04
	29	119.96	148.93	128.16	157.13	102.16	131.13	134.56	163.53	110.97	126.31	119.17	134.51	93.17	108.51	125.57	140.91
	35	117.75	150.58	125.95	158.78	99.95	132.78	132.35	165.18	108.79	118.58	116.99	126.78	90.99	100.78	123.39	133.18
	37	119.98	148.26	128.18	156.46	102.18	162.67	146.74	162.67	108.51	119.40	116.71	127.60	90.71	101.60	135.27	101.60
	44	140.35	164.98	148.55	173.18	122.55	179.58	167.11	179.71	106.81	117.08	115.01	125.28	89.01	99.28	133.57	99.41
	43	120.00	150.68	128.20	158.88	102.20	132.88	134.60	165.28	110.58	125.88	118.78	134.08	92.78	108.08	125.18	140.48
	46	122.30	146.14	130.50	154.34	104.50	128.34	136.90	160.74	107.66	117.82	115.86	126.02	89.86	100.02	122.26	132.42
	61	117.05	143.80	125.25	152.00	99.25	126.00	131.65	158.40	108.51	119.40	116.71	127.60	90.71	101.60	123.11	155.51
	08	143.38	175.21	151.58	183.41	125.58	157.41	157.98	189.81	107.38	119.21	115.58	127.41	89.58	101.41	121.98	133.81
	20	128.40	158.62	136.60	166.82	110.60	140.82	143.00	173.22	106.83	117.08	115.03	125.28	89.03	99.28	121.43	131.68
04	120.80	150.65	129.00	158.85	103.00	132.85	135.40	165.25	111.60	125.21	119.80	133.41	93.80	107.41	126.20	139.81	

## Connector part numbers

<b>Basic Series</b>	<b>8D</b>	<b>0</b>	<b>-</b>	<b>11</b>	<b>TT</b>	<b>35</b>	<b>P</b>	<b>N</b>			<b>L</b>
<b>Shell style:</b>											
0: Square flange receptacle											
7: Jam nut receptacle											
5: Plug with RFI shielding											
<b>Type:</b>											
- : Connectors with standard crimp contacts											
L: Receptacle with long PC tail (male and female size #22D, #20)											
C: Receptacle with short PC tail (male and female #22D, #20, #16, #12)											
S: Receptacle with specific PC tail (male et female #22D)											
W: Receptacle with male contacts #22D for wire wrap (3 wraps)											
T: Receptacle with male contacts #20 for wire wrap (2 wraps)											
P: Receptacle with solder cup contacts - see page 69, please consult us											
<b>Shell size:</b>											
09, 11, 13, 15, 17, 19, 21, 23, 25											
<b>Plating:</b>											
TT: Without plating											
TF: Nickel											
<b>Contact layout:</b>											
See pages 13 to 19											
<b>Contact type:</b>											
P: Pin											
A: Connector supplied less pin contact or with specific contacts (connector marking: A + orientation)											
S: Socket											
B: Connector supplied less socket contact or with specific contacts (connector marking: B + orientation)											
<b>Orientation:</b>											
N, A, B, C, D, E (see page 75)											
<b>Specification:</b>											
046: Tinned straight PC tail											
251: Connector provided with power contacts (layouts with contact #8)											
022: Fuel tank											
<b>Special custom</b>											
None: Standard plastic cap											
M: Antistatic plastic cap											
L: For P or S contact type only, connectors delivered without contacts, connectors marking P or S plus orientation											

Note: PC tail contacts without shoulder also available. Please see page 102.

## Dimensions

Receptacle type 0																																																																											
		<table border="1"> <thead> <tr> <th>Shell size</th> <th>A Max</th> <th>B Max</th> <th>C Max</th> <th>D Thread</th> <th>E<sup>±0.3</sup></th> <th>F</th> <th>G</th> <th>H<sup>±0.2</sup></th> <th>J<sup>±0.2</sup></th> </tr> </thead> <tbody> <tr> <td>09 (A)</td> <td rowspan="5">20.2</td> <td rowspan="5">11.4</td> <td rowspan="5">2.5</td> <td>M12 x 1-6g</td> <td>23.8</td> <td>18.26</td> <td>15.09</td> <td rowspan="5">3.25</td> <td>5.49</td> </tr> <tr> <td>11 (B)</td> <td>M15 x 1-6g</td> <td>26.2</td> <td>20.62</td> <td>18.26</td> <td>4.93</td> </tr> <tr> <td>13 (C)</td> <td>M18 x 1-6g</td> <td>28.6</td> <td>23.01</td> <td>20.62</td> <td>4.4</td> </tr> <tr> <td>15 (D)</td> <td>M22 x 1-6g</td> <td>31</td> <td>24.61</td> <td>23.01</td> <td rowspan="2">4.93</td> </tr> <tr> <td>17 (E)</td> <td>M25 x 1-6g</td> <td>33.3</td> <td>26.97</td> <td>24.61</td> </tr> <tr> <td>19 (F)</td> <td rowspan="3">19.8</td> <td>11.8</td> <td rowspan="3">3.2</td> <td>M28 x 1-6g</td> <td>36.5</td> <td>29.36</td> <td>26.97</td> <td rowspan="3">3.91</td> <td rowspan="3">6.15</td> </tr> <tr> <td>21 (G)</td> <td>M31 x 1-6g</td> <td>39.7</td> <td>31.75</td> <td>29.36</td> </tr> <tr> <td>23 (H)</td> <td>M34 x 1-6g</td> <td>42.9</td> <td>34.93</td> <td>31.75</td> </tr> <tr> <td>25 (J)</td> <td></td> <td>11.4</td> <td></td> <td>M37 x 1-6g</td> <td>46</td> <td>38.1</td> <td>34.93</td> <td></td> <td></td> </tr> </tbody> </table>	Shell size	A Max	B Max	C Max	D Thread	E <sup>±0.3</sup>	F	G	H <sup>±0.2</sup>	J <sup>±0.2</sup>	09 (A)	20.2	11.4	2.5	M12 x 1-6g	23.8	18.26	15.09	3.25	5.49	11 (B)	M15 x 1-6g	26.2	20.62	18.26	4.93	13 (C)	M18 x 1-6g	28.6	23.01	20.62	4.4	15 (D)	M22 x 1-6g	31	24.61	23.01	4.93	17 (E)	M25 x 1-6g	33.3	26.97	24.61	19 (F)	19.8	11.8	3.2	M28 x 1-6g	36.5	29.36	26.97	3.91	6.15	21 (G)	M31 x 1-6g	39.7	31.75	29.36	23 (H)	M34 x 1-6g	42.9	34.93	31.75	25 (J)		11.4		M37 x 1-6g	46	38.1	34.93		
Shell size	A Max	B Max	C Max	D Thread	E <sup>±0.3</sup>	F	G	H <sup>±0.2</sup>	J <sup>±0.2</sup>																																																																		
09 (A)	20.2	11.4	2.5	M12 x 1-6g	23.8	18.26	15.09	3.25	5.49																																																																		
11 (B)				M15 x 1-6g	26.2	20.62	18.26		4.93																																																																		
13 (C)				M18 x 1-6g	28.6	23.01	20.62		4.4																																																																		
15 (D)				M22 x 1-6g	31	24.61	23.01		4.93																																																																		
17 (E)				M25 x 1-6g	33.3	26.97	24.61																																																																				
19 (F)	19.8	11.8	3.2	M28 x 1-6g	36.5	29.36	26.97	3.91	6.15																																																																		
21 (G)		M31 x 1-6g		39.7	31.75	29.36																																																																					
23 (H)		M34 x 1-6g		42.9	34.93	31.75																																																																					
25 (J)		11.4		M37 x 1-6g	46	38.1	34.93																																																																				

Receptacle type 7																																																																		
		<table border="1"> <thead> <tr> <th>Shell size</th> <th>A<sup>±0.15</sup></th> <th>B Max</th> <th>C Max</th> <th>D Thread</th> <th>E Max</th> <th>F<sup>±0.4</sup></th> <th>ØG Max</th> </tr> </thead> <tbody> <tr> <td>09 (A)</td> <td>16.53</td> <td rowspan="9">9.9</td> <td rowspan="9">3.2</td> <td>M12 x 1-6g</td> <td>23</td> <td>27</td> <td>30.5</td> </tr> <tr> <td>11 (B)</td> <td>19.07</td> <td>M15 x 1-6g</td> <td>26</td> <td>31.8</td> <td>35.2</td> </tr> <tr> <td>13 (C)</td> <td>23.82</td> <td>M18 x 1-6g</td> <td>31</td> <td>34.9</td> <td>38.4</td> </tr> <tr> <td>15 (D)</td> <td>26.97</td> <td>M22 x 1-6g</td> <td>34</td> <td>38.1</td> <td>41.6</td> </tr> <tr> <td>17 (E)</td> <td>30.15</td> <td>M25 x 1-6g</td> <td>37</td> <td>41.3</td> <td>44.8</td> </tr> <tr> <td>19 (F)</td> <td>33.32</td> <td>M28 x 1-6g</td> <td>41</td> <td>46</td> <td>49.5</td> </tr> <tr> <td>21 (G)</td> <td>36.50</td> <td>M31 x 1-6g</td> <td>46</td> <td>49.2</td> <td>52.7</td> </tr> <tr> <td>23 (H)</td> <td>39.67</td> <td>M34 x 1-6g</td> <td>47</td> <td>52.4</td> <td>55.9</td> </tr> <tr> <td>25 (J)</td> <td>42.85</td> <td>M37 x 1-6g</td> <td>51.23</td> <td>55.6</td> <td>59</td> </tr> </tbody> </table>	Shell size	A <sup>±0.15</sup>	B Max	C Max	D Thread	E Max	F <sup>±0.4</sup>	ØG Max	09 (A)	16.53	9.9	3.2	M12 x 1-6g	23	27	30.5	11 (B)	19.07	M15 x 1-6g	26	31.8	35.2	13 (C)	23.82	M18 x 1-6g	31	34.9	38.4	15 (D)	26.97	M22 x 1-6g	34	38.1	41.6	17 (E)	30.15	M25 x 1-6g	37	41.3	44.8	19 (F)	33.32	M28 x 1-6g	41	46	49.5	21 (G)	36.50	M31 x 1-6g	46	49.2	52.7	23 (H)	39.67	M34 x 1-6g	47	52.4	55.9	25 (J)	42.85	M37 x 1-6g	51.23	55.6	59
Shell size	A <sup>±0.15</sup>	B Max	C Max	D Thread	E Max	F <sup>±0.4</sup>	ØG Max																																																											
09 (A)	16.53	9.9	3.2	M12 x 1-6g	23	27	30.5																																																											
11 (B)	19.07			M15 x 1-6g	26	31.8	35.2																																																											
13 (C)	23.82			M18 x 1-6g	31	34.9	38.4																																																											
15 (D)	26.97			M22 x 1-6g	34	38.1	41.6																																																											
17 (E)	30.15			M25 x 1-6g	37	41.3	44.8																																																											
19 (F)	33.32			M28 x 1-6g	41	46	49.5																																																											
21 (G)	36.50			M31 x 1-6g	46	49.2	52.7																																																											
23 (H)	39.67			M34 x 1-6g	47	52.4	55.9																																																											
25 (J)	42.85			M37 x 1-6g	51.23	55.6	59																																																											
<p><b>Recommended coupling torque on panel for jam nut receptacle (type 7)</b></p> <table border="1"> <thead> <tr> <th>Shell</th> <th>09 (A)</th> <th>11 (B)</th> <th>13 (C)</th> <th>15 (D)</th> <th>17 (E)</th> <th>19 (F)</th> <th>21 (G)</th> <th>23 (H)</th> <th>25 (J)</th> </tr> </thead> <tbody> <tr> <td>Coupling torque (±0.5 N.m)</td> <td>4</td> <td>5</td> <td>7</td> <td>8</td> <td>9</td> <td>10</td> <td>12</td> <td>13</td> <td>14</td> </tr> </tbody> </table>								Shell	09 (A)	11 (B)	13 (C)	15 (D)	17 (E)	19 (F)	21 (G)	23 (H)	25 (J)	Coupling torque (±0.5 N.m)	4	5	7	8	9	10	12	13	14																																							
Shell	09 (A)	11 (B)	13 (C)	15 (D)	17 (E)	19 (F)	21 (G)	23 (H)	25 (J)																																																									
Coupling torque (±0.5 N.m)	4	5	7	8	9	10	12	13	14																																																									

Note: All dimensions are in millimeters (mm)



### Plug type 5

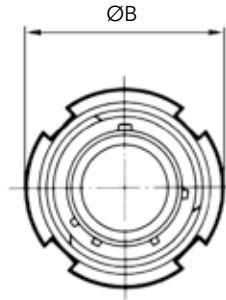
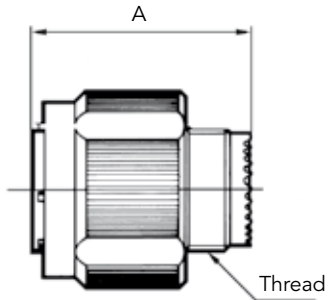

Shell size	A Max	Thread	ØB Max
09 (A)	31.00	M12 x 1-6g	21.80
11 (B)		M15 x 1-6g	25.00
13 (C)		M18 x 1-6g	29.40
15 (D)		M22 x 1-6g	32.50
17 (E)		M25 x 1-6g	35.70
19 (F)		M28 x 1-6g	38.50
21 (G)		M31 x 1-6g	41.70
23 (H)		M34 x 1-6g	44.90
25 (J)		M37 x 1-6g	48.00

### Mated connectors dimensions

Type 0 with plug

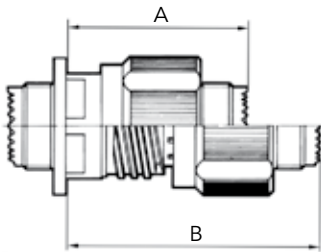

Type 7 with plug

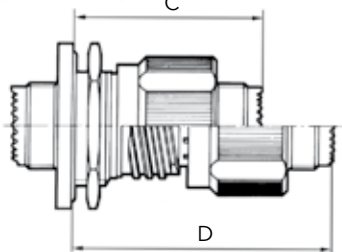

Shell size	A Max	B Max	C Max	D Max
09 (A)	37.00	52.30	38.30	53.60
11 (B)			38.50	53.80
13 (C)				
15 (D)				
17 (E)	36.00	51.30	38.50	53.80
19 (F)				
21 (G)				
23 (H)				
25 (J)				

Note: All dimensions are in millimeters (mm)

Receptacle with straight PC tail contacts



		Shell size			09 (A)	11 (B)	13 (C)	15 (C)	17 (E)	19 (F)	21 (G)	23 (H)	25 (J)
		Contact size	Contact type	PC tail type									
A		#22D	M & F	L & C	0.70								
		#22D	M & F	S	0.50								
		#20	M & F	C	0.70								
		#16	M & F	C	1.12 <sup>±0.03</sup>								
L1	Min	#22D	M	L & C	10.52					10.34			
	Max	#22D	M	L & C	11.46					11.28			
	Min	#22D	F	L & C	10.19					10.01			
	Max	#22D	F	L & C	11.46					11.28			
	Min	#22D	M	S	10.19					10.01			
	Max	#22D	M	S	11.46					11.28			
	Min	#22D	F	S	10.69					10.51			
	Max	#22D	F	S	11.63					11.45			
	Min	#20	M	C	10.36					10.18			
	Max	#20	M	C	11.63					11.45			
	Min	#20	F	C	10.69					10.51			
	Max	#20	F	C	11.63					11.45			
	Min	#16	M	C	10.69					10.51			
	Max	#16	M	C	11.63					11.45			
	Min	#16	F	C	10.69					10.51			
	Max	#16	F	C	11.63					11.45			
L2		#22D	M & F	L	8.50								
		#22D	M & F	C	4.00								
		#22D	M & F	S	5.10								
		#20	M & F	C	5.10								
		#16	M & F	C	5 <sup>±0.1</sup>								
L3	Min	#22D	M	L & C			9.48					9.59	
	Max	#22D	M	L & C			10.58					10.69	
	Min	#22D	F	L & C			9.15					9.26	
	Max	#22D	F	L & C			10.58					10.69	
	Min	#22D	M	S			9.65					9.76	
	Max	#22D	M	S			10.75					10.86	
	Min	#22D	F	S			9.15					9.26	
	Max	#22D	F	S			10.75					10.86	
	Min	#20	M	C			9.65					9.76	
	Max	#20	M	C			10.75					10.86	
	Min	#20	F	C			9.65					9.76	
	Max	#20	F	C			10.75					10.86	
	Min	#16	M	C			9.64					9.75	
	Max	#16	M	C			10.75					10.86	
	Min	#16	F	C			9.64					9.75	
	Max	#16	F	C			10.75					10.86	

M: Male contact    F: Female contact    L: Long PC tail    C: Short PC tail    S: Specific PC tail

Note: All dimensions are in millimeters (mm)

## Connectors weight - in gram ( $\pm 15\%$ )

Shell size & Layout		With contacts						Without contacts					
		Plug (type 5)		Receptacle (type 0)		Receptacle (type 7)		Plug (type 5)		Receptacle (type 0)		Receptacle (type 7)	
		Male	Female	Male	Female	Male	Female	Male	Female	Male	Female	Male	Female
09	35	18.23	19.81	14.37	15.95	20.14	21.72	17.81	18.31	13.95	14.45	19.72	20.22
	98	18.23	19.53	14.37	15.67	20.14	21.44	17.81	18.33	13.95	14.47	19.72	20.24
11	01	23.15	26.09	18.19	21.13	25.63	28.57	22.49	24.49	17.53	19.53	24.97	26.97
	02	22.78	25.32	17.82	20.36	28.1	30.64	22.16	23.76	17.2	18.8	27.48	29.08
	04	22.97	26.03	18.01	21.07	25.45	28.51	22.41	24.43	17.45	19.47	24.89	26.91
	05	23.00	26.21	18.04	21.25	25.24	28.69	22.30	24.21	17.34	19.25	24.78	26.69
	22	22.64	25.06	17.68	20.10	27.96	30.38	22.36	24.06	17.40	19.10	27.68	29.38
	35	22.90	26.37	17.94	21.41	25.14	28.85	21.99	23.12	17.03	18.16	24.47	25.60
	80	25.38	29.86	20.08	24.88	30.66	35.78	22.10	22.86	16.80	17.88	27.38	28.78
	98	22.87	25.63	17.91	20.67	25.35	28.11	22.03	23.23	17.07	18.27	24.51	25.71
	99	23.04	26.26	18.06	21.28	25.53	28.75	22.06	23.46	17.08	18.48	24.55	25.95
13	04	32.44	36.22	23.56	27.34	34.11	37.89	31.20	33.10	22.32	24.22	32.87	34.77
	08	32.82	38.00	23.94	29.12	34.49	39.67	31.70	34.80	22.82	25.92	33.37	36.47
	26	33.19	38.84	24.31	29.96	34.86	40.51	31.45	34.14	22.57	25.26	33.12	35.81
	35	32.62	38.39	23.74	29.51	34.29	40.06	31.08	32.89	22.20	24.01	32.75	34.56
	98	32.48	37.10	23.60	28.22	34.15	38.77	31.08	33.10	22.20	24.22	32.75	34.77
15	05	39.61	44.95	28.77	34.11	41.40	46.74	38.06	41.05	27.22	30.21	39.85	42.84
	15	40.41	47.57	29.57	36.73	42.20	49.36	38.14	41.19	27.30	30.35	39.93	42.98
	18	40.62	49.50	29.78	38.66	42.41	51.29	38.10	42.30	27.26	31.46	39.89	44.09
	19	40.15	47.88	29.31	37.04	41.94	49.67	37.49	40.28	26.65	29.44	39.28	42.07
	35	40.25	49.49	29.41	38.65	42.04	51.28	37.66	40.24	26.82	29.40	39.45	42.03
	97	40.08	47.13	29.24	36.29	41.87	48.92	37.72	40.81	26.88	29.97	39.51	42.60
17	02	48.16	58.40	45.20	55.44	63.99	74.23	44.89	51.85	41.93	48.89	60.72	67.68
	06	43.73	53.33	40.90	50.50	54.23	63.83	39.77	43.73	36.94	40.90	50.27	54.23
	08	42.72	51.45	39.89	48.62	53.22	61.95	40.24	45.21	37.41	42.38	50.74	55.71
	26	43.30	54.09	40.47	51.26	53.80	64.59	39.66	43.69	36.83	40.86	50.16	54.19
	35	43.54	57.09	40.71	54.26	54.04	67.59	39.69	43.34	36.86	40.51	50.19	53.84
	75	49.14	60.43	46.31	57.60	59.64	70.93	40.14	46.43	37.31	43.60	50.64	56.93
19	99	43.35	53.91	40.52	51.08	53.85	64.41	39.79	43.95	36.96	41.12	50.29	54.45
	11	55.16	68.75	44.00	57.59	61.25	74.84	51.75	60.17	40.59	66.26	40.59	66.26
	32	54.37	67.77	43.21	56.61	60.46	73.86	49.89	54.97	38.73	61.06	38.73	61.06
21	35	54.68	71.13	43.52	59.97	60.77	77.22	50.06	54.63	38.90	60.72	38.90	60.72
	11	64.64	84.48	54.31	74.15	71.62	91.46	57.38	66.88	47.05	73.86	47.05	73.86
	16	61.74	77.02	51.41	66.69	68.72	84.00	56.78	64.54	46.45	71.52	46.45	71.52
	35	62.02	82.68	51.69	72.35	69.00	89.66	56.49	62.93	46.16	69.91	46.16	69.91
	39	63.40	83.73	53.07	73.40	70.38	90.71	57.60	67.37	47.27	74.35	47.27	74.35
	41	61.94	79.31	51.61	86.29	68.92	86.29	56.20	62.91	45.87	69.89	45.87	69.89
	48	68.73	88.71	58.4	78.38	81.56	101.54	55.61	62.51	45.28	52.18	68.44	75.34
23	75	73.61	90.51	63.28	80.18	86.44	103.34	55.61	62.51	45.28	52.18	68.44	75.34
	21	71.07	94.32	60.57	83.82	79.15	102.40	64.56	77.94	54.06	86.02	54.06	86.02
	35	69.43	95.58	58.93	85.08	77.51	103.66	62.43	70.58	51.93	78.66	51.93	78.66
	53	69.49	91.68	58.99	81.18	77.57	99.76	62.07	70.48	51.57	78.56	51.57	78.56
	55	70.24	93.31	59.74	82.81	78.32	101.39	62.54	71.31	52.04	79.39	52.04	79.39
25	07	83.91	117.09	73.64	123.58	99.34	121.8	68.12	78.84	57.85	85.33	83.55	83.55
	11	91.92	111.92	81.65	101.65	94.65	127.35	71.12	84.12	60.85	73.85	86.55	99.55
	19	81.78	113.79	71.51	103.52	90.20	122.21	69.24	83.39	58.97	91.81	58.97	91.81
	24	81.28	112.64	71.01	102.37	89.70	121.06	69.64	84.08	59.37	92.50	59.37	92.50
	29	79.60	108.57	69.33	98.30	88.02	116.99	70.61	85.95	60.34	94.37	60.34	94.37
	35	77.39	110.22	67.12	99.95	85.81	118.64	68.43	78.22	58.16	86.64	58.16	86.64
	37	79.59	107.09	69.32	116.12	95.02	113.36	68.12	79.04	57.85	87.26	83.55	84.50
	44	99.96	127.50	89.69	134.23	115.39	134.44	66.42	77.85	56.15	86.33	81.85	84.54
	43	79.64	110.32	69.37	100.05	88.06	118.74	70.22	85.52	59.95	93.94	59.95	93.94
	46	81.94	105.78	71.67	95.51	90.36	114.20	67.30	77.46	57.03	85.88	57.03	85.88
	61	76.69	103.44	66.42	93.17	85.11	111.86	68.15	79.04	57.88	87.46	57.88	87.46
	08	103.02	134.85	92.75	124.58	111.44	143.27	67.02	78.85	56.75	87.27	56.75	87.27
	20	88.04	118.26	77.77	107.99	96.46	126.68	66.47	76.72	56.20	85.14	56.20	85.14
	04	80.44	110.29	70.17	100.02	88.86	118.71	71.24	84.85	60.97	93.27	60.97	93.27

## Connector part numbers

<b>Basic Series</b>	JVS	16	A	11	35	P	N
<b>Shell style:</b>							
00: Square flange receptacle							
07: Jam nut receptacle							
16: Plug with RFI shielding							
<b>Material:</b>							
A: Bronze housing material							
<b>Shell size:</b>							
09, 11, 13, 15, 17, 19, 21, 23, 25							
<b>Contact layout:</b>							
See pages 13 to 19							
<b>Contact type:</b>							
P: Pin	A: Connector supplied less pin contact or with specific contacts (connector marking: A + orientation)						
S: Socket	B: Connector supplied less socket contact or with specific contacts (connector marking: B + orientation)						
<b>Orientation:</b>							
N, A, B, C, D, E (see page 75)							
<b>Specification:</b>							
251: Connector provides with power contacts (layouts with contacts #8)							
CI: Printed board mounting contacts							
LI: Receptacle with long PC tail (pin or socket #22D)							
L: For P or S contact type only, connectors delivered without contacts, connectors marking P or S plus orientation							

## CECC part numbers

<b>Basic Series</b>	C 752 002	B	B	98	M	C	N	A	0	1	G
<b>Shell style:</b>											
A: Plug											
B: Square flange receptacle											
C: Jam nut receptacle											
<b>Shell size:</b>											
09=A, 11=B, 13=C, 15=D, 17=E, 19=F, 21=G, 23=H, 25=J											
<b>Contact layout:</b>											
See pages 13 to 19											
<b>Contact type:</b>											
M: Pin											
F: Socket											
<b>Type of contact termination:</b>											
C: Crimp contact											
<b>Orientation:</b>											
N, A, B, C, D, E (see page 75)											
<b>Shell material:</b>											
A: Aluminum bronze											
<b>Supply code:</b>											
0: Connectors supplied with contacts											
1: Connectors supplied without contacts											
<b>Assessment level:</b>											
1: Level 1											
<b>Performance level:</b>											
G: Level G											

Note: C 752 002 refers to the abbreviated form of the CECC 75 201-002 type designation.

## Dimensions

### Receptacle type 00 (JVS) or type B (CECC)

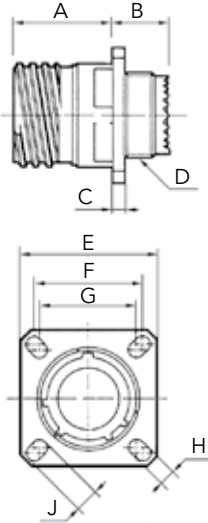

Shell size	A Max	B Max	C Max	D Thread	E <sup>±0.3</sup>	F	G	H <sup>±0.2</sup>	J <sup>±0.2</sup>
09 (A)	20.2	11.4	2.5	M12 x 1-6g	23.8	18.26	15.09	3.25	5.49
11 (B)				M15 x 1-6g	26.2	20.62	18.26		4.93
13 (C)				M18 x 1-6g	28.6	23.01	20.62		4.4
15 (D)				M22 x 1-6g	31	24.61	23.01		4.93
17 (E)				M25 x 1-6g	33.3	26.97	24.61		
19 (F)				M28 x 1-6g	36.5	29.36	26.97		
21 (G)	19.8	11.8	3.2	M31 x 1-6g	39.7	31.75	29.36	3.91	6.15
23 (H)		11.4		M34 x 1-6g	42.9	34.93	31.75		
25 (J)				M37 x 1-6g	46	38.1	34.93		

### Receptacle type 07 (JVS) or type C (CECC)

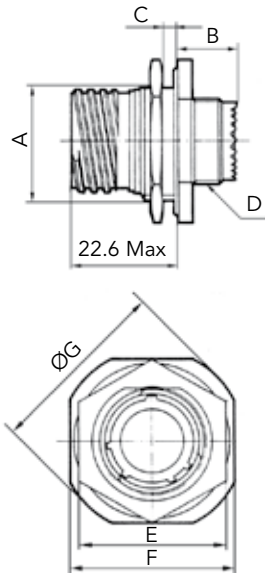

Shell size	A <sup>±0.15</sup>	B Max	C Max	D Thread	E Max	F <sup>±0.4</sup>	ØG Max
09 (A)	16.53	9.9	3.2	M12 x 1-6g	23	27	30.5
11 (B)	19.07			M15 x 1-6g	26	31.8	35.2
13 (C)	23.82			M18 x 1-6g	31	34.9	38.4
15 (D)	26.97			M22 x 1-6g	34	38.1	41.6
17 (E)	30.15			M25 x 1-6g	37	41.3	44.8
19 (F)	33.32			M28 x 1-6g	41	46	49.5
21 (G)	36.50			M31 x 1-6g	46	49.2	52.7
23 (H)	39.67			M34 x 1-6g	47	52.4	55.9
25 (J)	42.85			M37 x 1-6g	51.23	55.6	59

#### Recommended coupling torque on panel for jam nut receptacle (type 7)

Shell	09 (A)	11 (B)	13 (C)	15 (D)	17 (E)	19 (F)	21 (G)	23 (H)	25 (J)
Coupling torque (±0.5 N.m)	4	5	7	8	9	10	12	13	14

Note: All dimensions are in millimeters (mm)

### Plug type 16 (JVS) or type A (CECC)

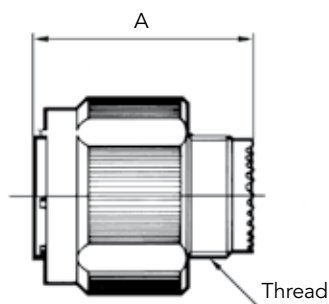

Shell size	A Max	Thread	ØB Max
09 (A)	31.00	M12 x 1-6g	21.10
11 (B)		M15 x 1-6g	23.80
13 (C)		M18 x 1-6g	28.20
15 (D)		M22 x 1-6g	31.40
17 (E)		M25 x 1-6g	36.50
19 (F)		M28 x 1-6g	39.30
21 (G)		M31 x 1-6g	42.50
23 (H)		M34 x 1-6g	45.30
25 (J)		M37 x 1-6g	48.40

### Mated connectors dimensions

Type 0 with plug

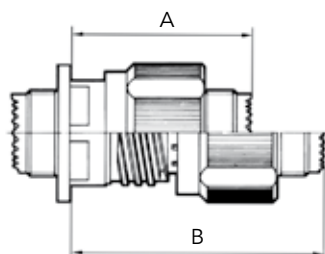

Type 7 with plug

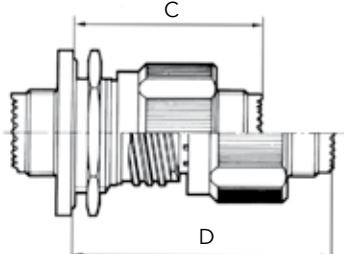

Shell size	A Max	B Max	C Max	D Max
09 (A)	37.00	52.30	38.30	53.60
11 (B)				
13 (C)				
15 (D)				
17 (E)				
19 (F)				
21 (G)	36.00	51.30		
23 (H)				
25 (J)				

### Dummy receptacle

Orientation:  
N, A, B, C, D, E

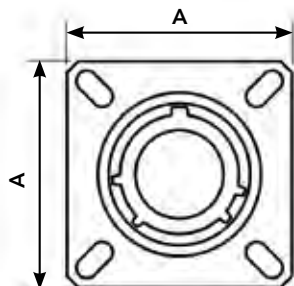

Orientation: DU  
(= all orientations)

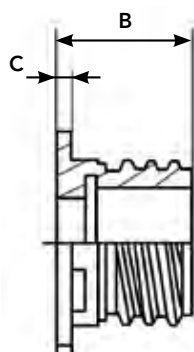
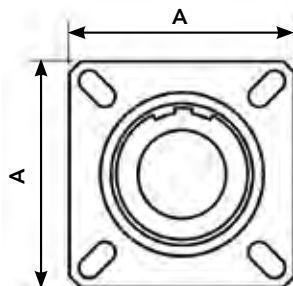

#### Examples of Part Number:

- . JVS BN 02 A 17 N
- . JVS BN 02 A 17 DU

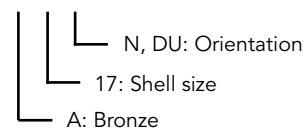

Equivalent to CECC blind hole. For information only:  
 CECC75201002AxA00A (x = shell size A, B, C, D, ...)  
 CECC75201002EA00A (blind hole) = JVSBN02A17DU  
 (through hole)  
 (no correspondance CECC with N, A, B, C, D, E orientations)

Shell size	9	11	13	15	17	19	21	23	25
A <sup>+0.3</sup> <sub>-0.3</sub>	23.8	26.2	28.6	31	33.3	36.5	39.7	42.9	46
B maxi	24.2	24.2	24.2	24.2	24.2	24.2	24.1	24.1	24.1
C maxi	2.5	2.5	2.5	2.5	2.5	2.5	3.2	3.2	3.2

Note: All dimensions are in millimeters (mm)

Receptacle with straight PC tail contacts

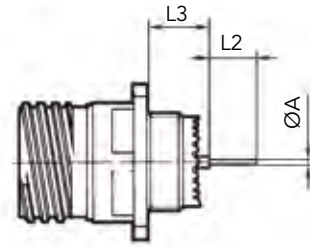
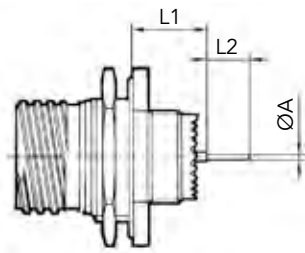

		Shell size			09 (A)	11 (B)	13 (C)	15 (C)	17 (E)	19 (F)	21 (G)	23 (H)	25 (J)
		Contact size	Contact type	PC tail type									
A		#22D	M & F	L & C	0.70								
		#22D	M & F	S	0.50								
		#20	M & F	C	0.70								
		#16	M & F	C	1.12 <sup>±0.03</sup>								
L1	Min	#22D	M	L & C	10.52					10.34			
	Max	#22D	M	L & C	11.46					11.28			
	Min	#22D	F	L & C	10.19					10.01			
	Max	#22D	F	L & C	11.46					11.28			
	Min	#22D	M	S	10.19					10.01			
	Max	#22D	M	S	11.46					11.28			
	Min	#22D	F	S	10.69					10.51			
	Max	#22D	F	S	11.63					11.45			
	Min	#20	M	C	10.36					10.18			
	Max	#20	M	C	11.63					11.45			
	Min	#20	F	C	10.69					10.51			
	Max	#20	F	C	11.63					11.45			
	Min	#16	M	C	10.69					10.51			
	Max	#16	M	C	11.63					11.45			
	Min	#16	F	C	10.69					10.51			
	Max	#16	F	C	11.63					11.45			
L2		#22D	M & F	L	8.50								
		#22D	M & F	C	4.00								
		#22D	M & F	S	5.10								
		#20	M & F	C	5.10								
		#16	M & F	C	5 <sup>±0.1</sup>								
L3	Min	#22D	M	L & C			9.48					9.59	
	Max	#22D	M	L & C			10.58					10.69	
	Min	#22D	F	L & C			9.15					9.26	
	Max	#22D	F	L & C			10.58					10.69	
	Min	#22D	M	S			9.65					9.76	
	Max	#22D	M	S			10.75					10.86	
	Min	#22D	F	S			9.15					9.26	
	Max	#22D	F	S			10.75					10.86	
	Min	#20	M	C			9.65					9.76	
	Max	#20	M	C			10.75					10.86	
	Min	#20	F	C			9.65					9.76	
	Max	#20	F	C			10.75					10.86	
	Min	#16	M	C			9.64					9.75	
	Max	#16	M	C			10.75					10.86	
	Min	#16	F	C			9.64					9.75	
	Max	#16	F	C			10.75					10.86	

M: Male contact    F: Female contact    L: Long PC tail    C: Short PC tail    S: Specific PC tail

Note: All dimensions are in millimeters (mm)

Connectors weight - in gram ( $\pm 15\%$ )

Shell size & Layout		With contacts						Without contacts					
		Plug (type 5)		Receptacle (type 0)		Receptacle (type 7)		Plug (type 5)		Receptacle (type 0)		Receptacle (type 7)	
		Male	Female	Male	Female	Male	Female	Male	Female	Male	Female	Male	Female
09	35	28.46	32.38	22.70	26.62	34.51	38.43	27.42	28.66	21.66	22.90	33.47	34.71
	98	28.46	31.68	22.70	25.93	34.51	37.74	27.42	28.71	21.66	22.95	33.47	34.76
11	01	37.17	44.46	29.80	37.09	45.08	52.37	35.53	40.49	28.16	33.12	43.44	48.40
	02	36.25	42.55	28.88	35.18	44.17	50.47	34.71	38.68	27.34	31.32	42.63	46.60
	04	36.72	44.31	29.35	36.94	44.63	52.23	35.33	40.34	27.96	32.97	43.24	48.26
	05	36.79	44.76	29.42	37.39	48.33	52.67	35.06	39.80	27.69	32.43	42.97	47.71
	22	35.90	41.91	28.53	34.54	43.82	49.82	35.21	39.43	27.84	32.06	43.13	47.34
	35	36.55	45.15	29.18	37.79	43.86	53.07	34.29	37.09	26.92	29.72	42.20	45.01
	80	45.40	54.33	37.96	46.89	53.35	70.43	34.23	36.45	26.79	29.08	42.77	44.37
	98	36.47	43.32	29.10	35.95	44.39	51.23	34.39	37.36	27.02	30.00	42.30	45.28
	99	36.90	44.89	29.53	37.52	44.81	52.80	34.46	37.94	27.09	30.57	42.38	45.86
13	04	52.20	61.58	38.98	48.35	59.89	69.27	49.12	53.84	35.90	40.61	56.81	61.53
	08	53.14	65.99	39.92	52.77	60.83	73.69	50.36	58.06	37.14	44.83	58.06	65.75
	26	54.06	68.08	40.84	54.85	61.75	75.77	49.74	56.42	36.52	43.19	57.44	64.11
	35	52.65	66.96	39.42	53.74	60.34	74.65	48.83	53.32	35.60	40.09	56.52	61.01
	98	52.30	63.76	39.08	50.54	59.99	71.45	48.83	53.84	35.60	40.61	56.52	61.53
15	05	64.61	77.85	48.48	61.73	73.49	86.74	60.76	68.18	44.63	52.05	69.64	77.06
	15	66.59	84.35	50.46	68.23	75.47	93.24	60.96	68.53	44.83	52.40	69.84	77.41
	18	67.11	89.14	50.98	73.02	75.99	98.02	60.86	71.28	44.73	55.15	69.74	80.16
	19	65.94	85.12	49.82	69.00	74.83	94.01	59.35	66.27	43.22	50.14	68.23	75.15
	35	66.19	89.12	50.07	72.99	75.08	98.00	59.77	66.17	43.64	50.04	68.65	75.05
	97	65.77	83.26	49.64	67.14	74.65	92.14	59.92	67.58	43.79	51.46	68.80	76.46
17	02	71.16	103.09	66.95	86.21	93.75	113.01	64.00	73.93	59.79	69.71	86.59	96.51
	06	74.18	98.00	69.99	93.81	96.76	120.58	64.36	74.18	60.16	69.99	86.93	96.76
	08	71.68	93.34	67.48	89.14	94.25	115.91	65.52	77.85	61.33	73.66	88.10	100.43
	26	73.12	99.89	68.92	95.69	95.69	122.46	64.08	74.08	59.89	69.89	86.66	96.66
	35	73.71	107.33	69.52	103.14	96.29	129.91	64.16	73.21	59.97	69.02	86.74	95.79
	75	87.60	115.61	83.41	111.42	110.18	138.19	65.28	80.88	61.08	76.69	87.85	103.46
	99	73.24	99.44	69.05	95.25	95.82	122.02	64.41	74.73	60.21	70.53	86.98	97.30
19	11	93.71	127.42	77.08	110.8	110.70	144.42	85.25	106.14	68.62	115.19	76.56	123.13
	32	91.75	124.99	75.12	108.37	108.74	141.99	80.63	93.24	64.01	102.29	71.95	110.23
	35	92.52	133.33	75.89	116.71	109.51	109.39	81.05	92.39	64.43	101.45	72.37	109.39
21	11	112.91	162.13	97.53	146.75	131.96	181.19	94.90	118.47	79.52	128.84	88.20	137.52
	16	105.72	143.63	90.33	128.24	124.77	162.68	93.41	112.66	78.03	123.03	86.71	131.72
	35	106.41	157.67	91.03	142.29	125.46	176.72	92.69	108.67	77.31	119.04	85.99	127.72
	39	109.83	160.27	94.45	144.89	128.89	179.33	95.44	119.68	80.06	130.05	88.75	138.74
	41	106.21	149.31	90.83	159.68	125.27	168.36	91.97	108.62	76.59	118.99	85.27	127.67
	48	103.63	133.84	88.25	118.46	122.61	152.90	90.52	107.64	75.14	92.26	109.58	126.70
23	75	135.19	177.13	119.80	161.74	154.25	196.18	90.52	107.64	75.14	92.26	109.58	126.70
	21	125.27	182.95	109.64	167.32	146.95	204.63	109.11	142.31	93.48	154.32	103.16	163.99
	35	121.20	186.08	105.57	170.44	142.88	207.76	103.83	124.05	88.20	136.06	97.88	145.73
	53	121.35	176.40	105.72	160.77	143.03	198.08	102.94	123.8	87.31	135.81	96.98	145.49
25	55	123.21	180.44	107.58	164.81	144.89	202.13	104.10	125.86	88.47	137.87	98.15	147.55
	07	153.58	179.40	138.29	186.55	176.55	202.05	114.40	141.15	99.11	148.3	137.37	163.70
	11	142.64	181.90	127.35	166.61	165.62	204.80	121.84	154.10	106.55	138.81	144.82	177.08
	19	148.26	227.68	132.98	212.40	171.24	250.66	117.15	152.26	101.87	164.81	112.29	175.23
	24	147.02	224.83	131.74	209.55	170.00	247.80	118.15	153.97	102.86	166.52	113.28	176.94
	29	142.86	214.73	127.57	199.45	165.83	237.70	120.55	158.61	105.27	171.16	115.69	181.58
	35	137.37	218.82	122.09	203.54	160.35	241.80	115.14	139.43	99.86	151.99	110.28	162.41
	37	153.57	170.01	138.29	177.20	176.55	192.56	114.40	141.15	99.11	148.30	137.37	163.70
	44	143.71	183.40	128.18	195.16	166.69	206.58	110.17	135.50	94.64	147.50	133.15	158.68
	43	142.96	219.07	127.67	203.79	165.93	242.05	119.58	157.54	104.30	170.10	114.72	180.52
	46	148.66	207.81	133.38	192.53	171.64	230.78	112.34	137.55	97.06	150.10	107.48	160.52
	61	135.64	202.00	120.35	186.72	158.61	224.98	114.45	141.47	99.17	154.02	109.59	164.44
	08	200.96	279.93	185.68	264.65	223.94	302.91	111.65	141.00	96.36	153.55	106.78	163.97
	20	163.80	238.77	148.51	223.49	186.77	261.75	110.28	135.71	95.00	148.26	105.42	158.68
	04	144.94	219.00	129.66	203.71	167.91	241.97	122.11	155.88	106.83	168.44	117.25	178.86



## Backshell part numbers

<b>Basic Series</b>	<b>JVS</b>	<b>A</b>	<b>11</b>	<b>E</b>	<b>00</b>	<b>C</b>	<b>CC</b>
<b>Accessory style</b> A : Rear accessory (backshell)							
<b>Shell size:</b> 09, 11, 13, 15, 17, 19, 21, 23, 25							
<b>Accessory type:</b> A: Screened adaptor for use with compression spring or band strap B: Adaptor with strain relief cable clamp E: Screened adaptor with braid trap G: Environmental cone clamp screened adaptor P: Adaptor for heat shrink boot X: Cone clamp screened adaptor							
<b>Cable entry codification (see table below):</b> <b>For B, P and X type:</b> 00: Standard, by default choice <b>For other types:</b> 00: Standard, by default choice 03 to 32: Depending on backshell type, please refer to corresponding table							
<b>Angle:</b> A: Straight backshell (orientation by default) B: 45° backshell (except for «B Type» accessory) C: 90° right angle backshell							
<b>Variant:</b> <b>For all types:</b> None: Supplied without any other accessory <b>For E and X type:</b> CC: Cable clamp variant							

### How to built a backshell reference for types A, E or G

Backshell type	Shell size	Standard correspondance		Specific
		Entry codification	Entry size backshell	Other entry cofication
Type A & E	09	00	04	03
	11	00	06	05 to 03
	13	00	08	07 to 04
	15	00	10	09 to 06
	17	00	12	11 to 08
	19	00	13	12 to 09
	21	00	16	15 to 12
	23	00	18	17 to 14
25	00	20	19 to 16	

Backshell type	Shell size	Standard correspondance		Specific
		Entry codification	Entry size backshell	Other entry cofication
Type G	09	00		
	11	00	04	
	13	00	06	04
	15	00	10	08 to 04
	17	00	12	11 to 04
	19	00	12	10 to 04
	21	00	16	12 to 04
	23	00	16	12 to 04
25	00	16	12 to 04	

Examples:

To order a right angle backshell type "A" size 15 with entry size 10, placed your order with: JVS A15G00C  
To order a right angle backshell type "A" size 15 with entry size 06, placed your order with: JVS A15G06C

## Dimensions

### Type A - Screened adaptor for use with compression spring or band strap

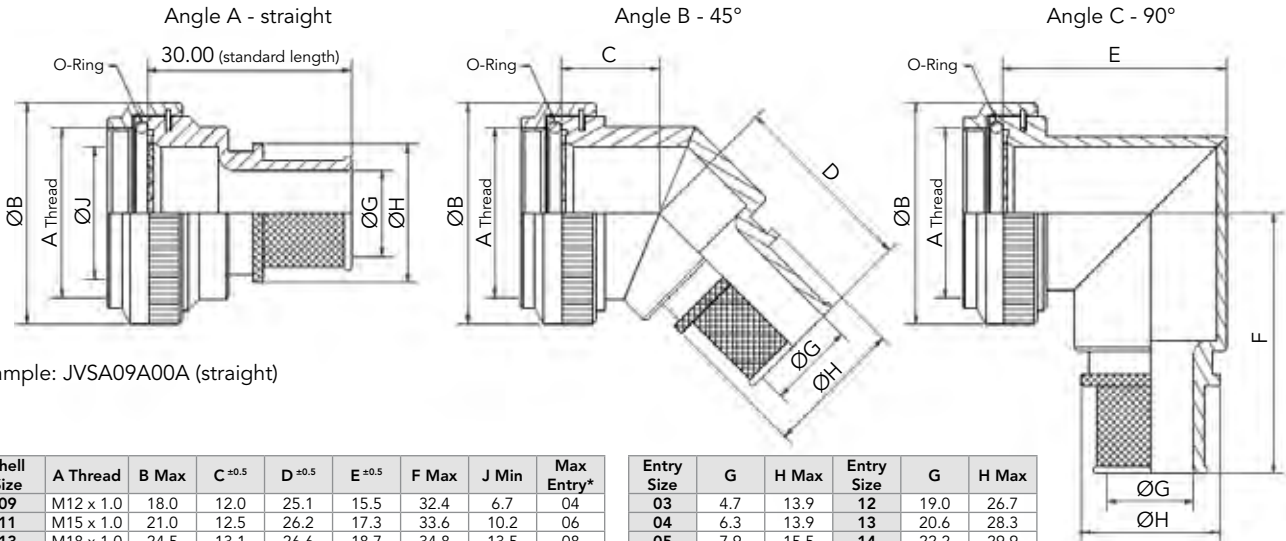

Example: JVSA09A00A (straight)

Shell Size	A Thread	B Max	C ±0.5	D ±0.5	E ±0.5	F Max	J Min	Max Entry*
09	M12 x 1.0	18.0	12.0	25.1	15.5	32.4	6.7	04
11	M15 x 1.0	21.0	12.5	26.2	17.3	33.6	10.2	06
13	M18 x 1.0	24.5	13.1	26.6	18.7	34.8	13.5	08
15	M22 x 1.0	29.0	13.5	27.5	21.3	36.6	16.2	10
17	M25 x 1.0	32.5	14.5	28.3	22.8	38.5	19.4	12
19	M28 x 1.0	35.5	15.5	28.8	24.4	40.3	21.8	13
21	M31 x 1.0	37.0	16.0	29.7	25.1	42.0	25.1	16
23	M34 x 1.0	40.0	16.5	30.0	26.6	43.4	28.2	18
25	M37 x 1.0	43.5	17.1	30.9	28.1	44.8	31.4	20

Entry Size	G	H Max	Entry Size	G	H Max
03	4.7	13.9	12	19.0	26.7
04	6.3	13.9	13	20.6	28.3
05	7.9	15.5	14	22.2	29.9
06	9.5	17.2	15	23.8	31.5
07	11.1	18.7	16	25.4	33.1
08	12.7	20.3	17	27.0	34.7
09	14.2	21.9	18	28.6	36.3
10	15.8	23.5	19	30.2	37.9
11	17.4	25.1	20	31.8	39.5

\* Recommendation only, please consult us for outside entry size

### Type B - Adaptor with strain relief cable clamp

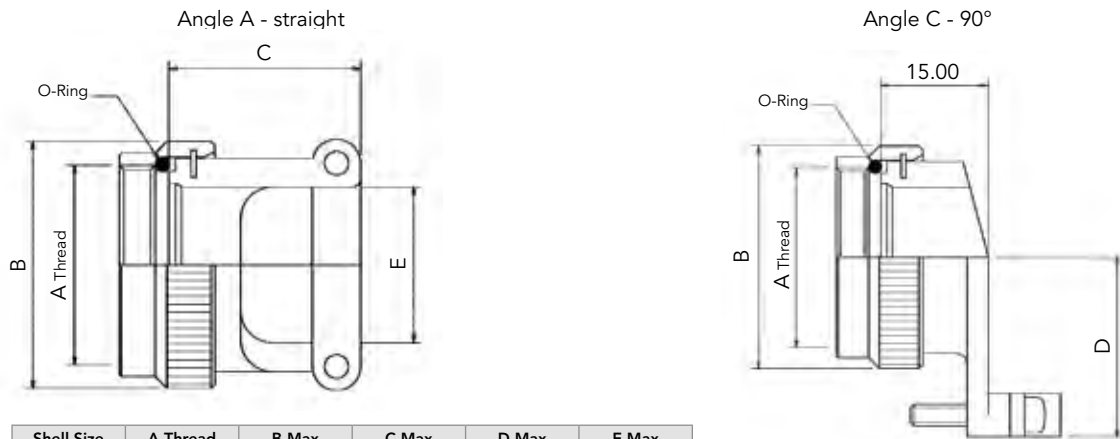

Shell Size	A Thread	B Max	C Max	D Max	E Max
09	M12 x 1.0	18.0	21.5	20.0	7.0
11	M15 x 1.0	21.0	21.5	21.0	10.5
13	M18 x 1.0	24.5	23.5	22.0	13.4
15	M22 x 1.0	29	23.5	23.0	16.5
17	M25 x 1.0	32.5	24.5	25.0	19.7
19	M28 x 1.0	35.5	27.5	27.5	22.2
21	M31 x 1.0	37.0	34.5	30.0	25.6
23	M34 x 1.0	40.0	37.5	31.5	28.5
25	M37 x 1.0	43.5	37.5	34.5	31.7

Example: JVSA09B00A (straight)

Note: All dimensions are in millimeters (mm)

### Type E - Screened adaptor with braid trap

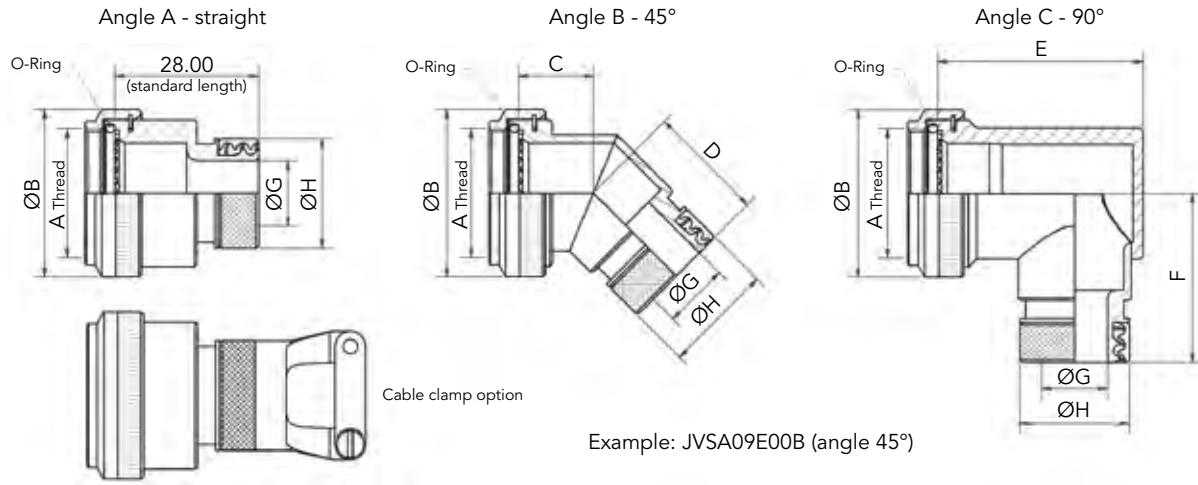

Shell Size	A Thread	B Max	C Max	D Max	E Max	F Max	Max Entry
09	M12 x 1.0	18.0	13.1	23.6	25.7	30.5	04
11	M15 x 1.0	21.0	13.9	24.4	26.7	32.2	06
13	M18 x 1.0	24.5	14.5	24.8	31.2	33.7	08
15	M22 x 1.0	29.0	15.5	25.6	37.2	35.2	10
17	M25 x 1.0	32.5	16.1	26.4	40.2	36.9	12
19	M28 x 1.0	35.5	16.8	26.8	44.7	38.5	13
21	M31 x 1.0	37.0	17.1	27.6	49.2	40.1	16
23	M34 x 1.0	40.0	17.7	28.0	51.7	41.6	18
25	M37 x 1.0	43.5	18.4	29.0	53.2	43.1	20

Entry Size	G	H Max	Entry Size	G	H Max
03	4.77	15.0	12	19.05	27.7
04	6.35	15.0	13	20.62	29.3
05	7.92	16.6	14	22.23	30.9
06	9.52	18.2	15	23.82	32.5
07	11.10	19.8	16	25.40	34.1
08	12.70	21.4	17	27.00	35.7
09	14.27	23.0	18	28.60	37.3
10	15.88	24.6	19	30.20	39.1
11	17.47	26.2	20	31.80	40.4

### Type G - Environmental cone clamp screened adaptor

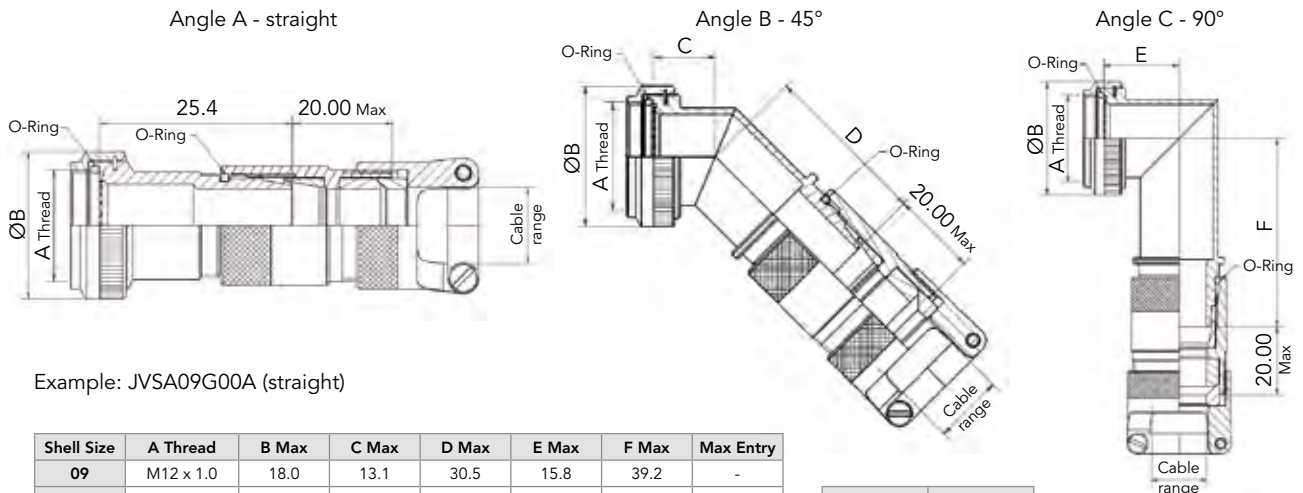

Shell Size	A Thread	B Max	C Max	D Max	E Max	F Max	Max Entry
09	M12 x 1.0	18.0	13.1	30.5	15.8	39.2	-
11	M15 x 1.0	21.0	13.9	30.5	17.6	42.3	04
13	M18 x 1.0	24.5	14.5	32.5	19.0	42.8	06
15	M22 x 1.0	29.0	15.5	40.3	21.5	50.5	10
17	M25 x 1.0	32.5	16.1	43.1	23.1	52.8	12
19	M28 x 1.0	35.5	16.8	47.9	24.5	57.1	12
21	M31 x 1.0	37.0	17.1	47.9	25.3	57.1	16
23	M34 x 1.0	40.0	17.7	56.5	27.5	64.7	16
25	M37 x 1.0	43.5	18.4	56.5	28.3	64.7	16

Entry Size	Cable Range
04	3.2 - 7.9
06	6.4 - 11.1
08	9.8 - 14.3
10	8.9 - 15.9
12	12.7 - 19.1
16	15.9 - 23.8

Note: All dimensions are in millimeters (mm)

### Type P - Adaptor for heat shrink boot

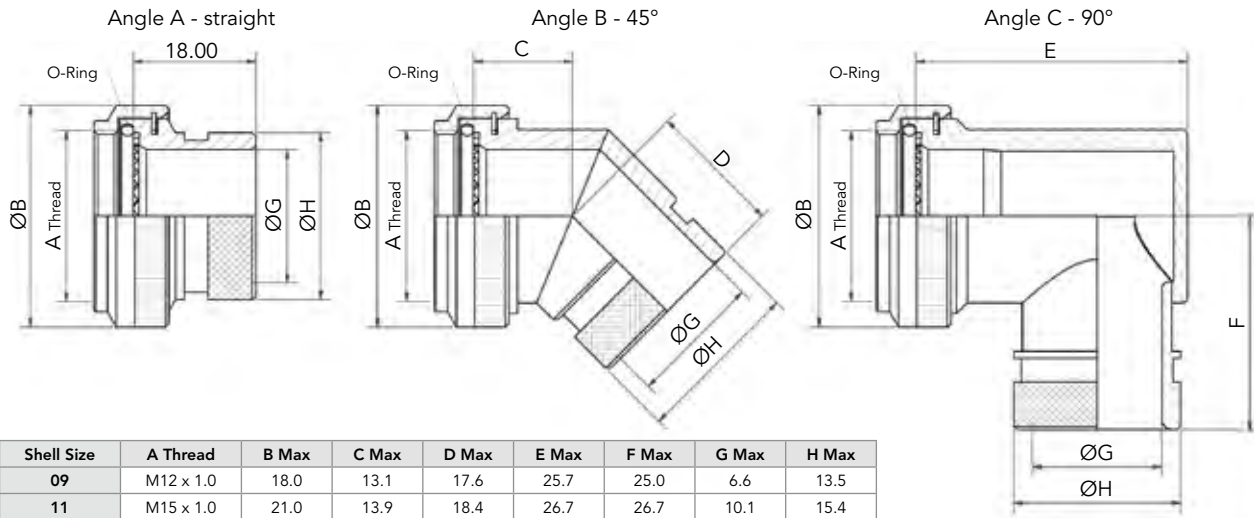

Shell Size	A Thread	B Max	C Max	D Max	E Max	F Max	G Max	H Max
09	M12 x 1.0	18.0	13.1	17.6	25.7	25.0	6.6	13.5
11	M15 x 1.0	21.0	13.9	18.4	26.7	26.7	10.1	15.4
13	M18 x 1.0	24.5	14.5	19.3	31.2	28.2	13.4	19.7
15	M22 x 1.0	29	15.5	19.6	37.2	29.7	16.1	21.3
17	M25 x 1.0	32.5	16.1	20.4	40.2	31.4	19.3	24.5
19	M28 x 1.0	35.5	16.8	20.8	44.7	33.0	21.7	26.5
21	M31 x 1.0	37.0	17.1	21.6	49.2	34.6	25	31.0
23	M34 x 1.0	40.0	17.7	22.5	51.7	36.1	28.1	34.4
25	M37 x 1.0	43.5	18.4	22.9	53.2	37.6	31.3	36.6

Example: JVSA09P00C (angle 90°)

### Type X - Cone clamp screened adaptor

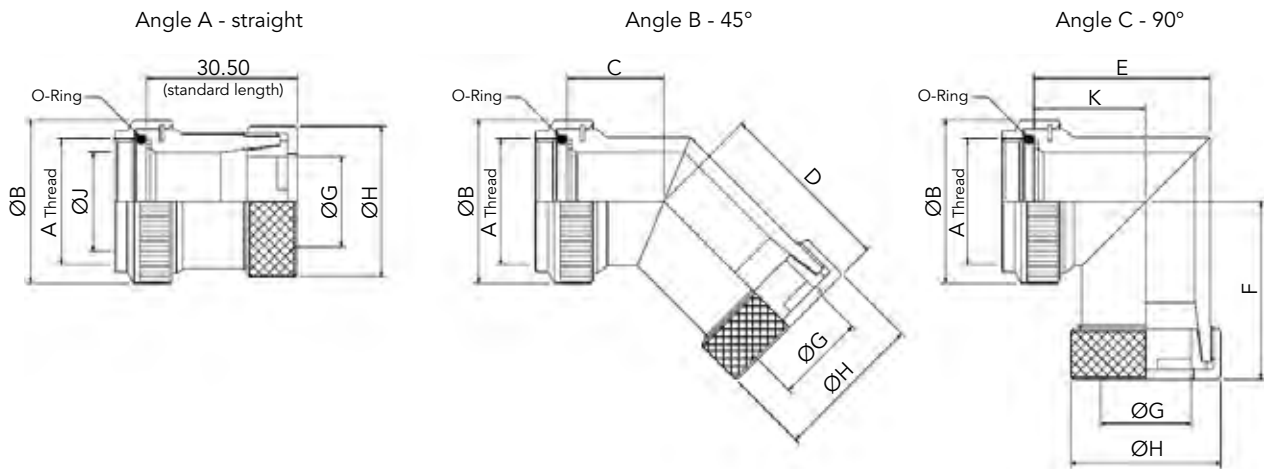

Shell Size	A Thread	B Max	C Max	D Max	E Max	F Max	G Min	H Max	J Min	K ±0.5
09	M12 x 1.0	18.0	12.0	33.3	21.1	35.2	6.9	18.4	6.7	15.5
11	M15 x 1.0	21.0	12.5	34.5	24.2	37.0	9.6	22.0	10.2	17.3
13	M18 x 1.0	24.5	13.1	34.9	27.4	38.5	12.7	24.0	13.5	18.7
15	M22 x 1.0	27.5	13.5	35.8	31.2	40.0	14.8	27.0	16.2	21.3
17	M25 x 1.0	31.0	14.5	36.6	34.3	41.2	17.9	29.5	19.4	22.8
19	M28 x 1.0	34.0	15.5	36.6	37.1	43.3	19.9	33.9	21.8	24.4
21	M31 x 1.0	37.0	16.0	37.7	39.4	44.9	23.1	37.0	25.1	25.1
23	M34 x 1.0	40.0	16.5	38.1	42.5	46.4	26.2	40.8	28.2	26.6
25	M37 x 1.0	43.5	17.1	39.0	45.6	47.9	28.8	43.0	31.4	28.1

Example: JVSA09X00B (angle 45°)

Note: All dimensions are in millimeters (mm)

# Caps

<b>Basic Series</b>	JVS	B	09	B	00	A
<b>Accessory style:</b> B: Protective cap						
<b>Shell size:</b> 09, 11, 13, 15, 17, 19, 21, 23, 25						
<b>Variant:</b> A: Cap for plug with eyelet (see drawing below) B: Cap for plug with ring (see drawing below) C: Cap for receptacle with eyelet (see drawing below) D: Cap for receptacle with ring (see drawing below)						
<b>Sub variant:</b> Not applicable						
<b>Material:</b> A: Bronze						

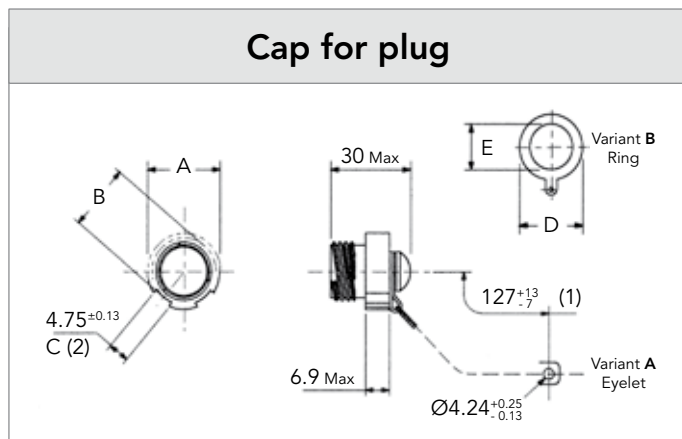

(1) Flexible metal link - (2) Number of notch on A diameter

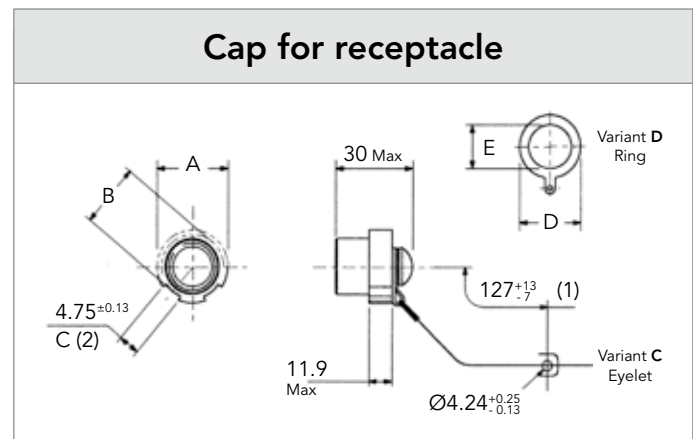

(1) Flexible metal link - (2) Number of notch on A diameter

Shell size	A Max	B Max	C	Cap for Plug		Cap for Receptacle	
				D Max	E Min	D Max	E Min
09 (A)	21.1	19.20	8	24.20	13.50	26.80	18.40
11 (B)	23.8	21.80		26.80	18.40	31.60	23.00
13 (C)	28.2	26.10	10	30.50	19.80	36.90	26.20
15 (D)	31.4	29.30		31.60	23.00	40.10	29.40
17 (E)	36.5	34.40	12	36.90	26.20	43.20	32.50
19 (F)	39.3	37.20		40.10	29.40	46.40	35.70
21 (G)	42.5	40.50	16	43.20	32.50	49.20	39.10
23 (H)	45.3	43.10		46.40	35.70	52.80	42.10
25 (J)	48.4	46.10	18	49.20	39.10	55.50	45.30

Equivalent to CECC, for information CECC75201002Bxy00A (x = shell size, y = variant)  
Example: CECC75201002BAC00A = JVS B09 C00A

Note: All dimensions are in millimeters (mm)

# 8D SERIES

# Common Section

■	Contacts:	
	Crimp contacts .....	64
	Straight PC tail contacts .....	68
	Coax contacts #12 .....	69
	Solder cup .....	69
	Crimp contacts: 1500 mating .....	69
	Wire wrap contacts .....	69
	Quadrax #8 contacts .....	69
	Thermocouple contacts .....	70
	Dummy contacts .....	70
	Filler plugs .....	70
■	Wiring instruction .....	71
■	Tooling:	
	Crimping tools .....	72
	Insertion and extraction tools .....	73
	Backshell tightening tools .....	73
	Tightening support .....	73
	Slackening tools .....	73
■	Accessories:	
	Gaskets .....	74
	Plastic protective caps .....	74
■	Orientations .....	75
■	Panel cut-out .....	75
■	Coordinates for straight PC tail terminations .....	76

**MIL-DTL-38999 qualified crimp contacts - 1.27µm gold plated**

Contact size	Contact type	Part number	Contact Ø	Conductor section AWG		Conductor section mm <sup>2</sup>		External Ø over insulator	
				Min	Max	Min	Max	Min	Max
#22D	Pin	M39029/58 360	0.76	26	22	0.12	0.34	0.76	1.37
	Socket	M39029/56 348							
#20	Pin	M39029/58 363	1.00	24	20	0.21	0.60	1.02	2.11
	Socket	M39029/56 351							
#16	Pin	M39029/58 364	1.60	20	16	0.60	1.34	1.65	2.77
	Socket	M39029/56 352							
#16 Coax	Pin	M39029/76 424		RG 174 RG 179 RG 316				1.65	2.60
	Socket	M39029/77 428							
#12	Pin	M39029/58 365	2.40	14	12	1.91	3.18	2.46	3.61
	Socket	M39029/56 353							
#12 Coax	Pin	M39029/102 558		RG 174 RG 179 RG 316				2.40	2.60
	Socket	M39029/103 559							
	Pin	M39029/28 211							
	Socket	M39029/75 416							
#10 Power	Pin	M39029/58 528	3.20	Please consult us				-	2.95
	Socket	M39029/56 527							
#8 Coax	Pin	M39029/60 367	3.64	RG 180 A/U				-	2.80
	Socket	M39029/59 366							
#8 Concentric Twinax (= Triax)	Pin	M39029/90 529	5.50	0,76MIL-C17/176 00002 FILECA F.2703/14 RAYCHEM CHEMINAX 10612 FILOTEX M 17/176 00002				3.15	3.40
	Socket	M39029/91 530							



**MIL-DTL-38999 qualified crimp contacts - 1.27µm gold plated**

Contact size	Contact type	Profile	Color code
#22D	Pin		Black / Blue / Orange
	Socket		Gray / Yellow / Orange
#20	Pin		Orange / Blue / Orange
	Socket		Brown / Green / Orange
#16	Pin		Yellow / Blue / Orange
	Socket		Red / Green / Orange
#16 Coax	Pin		Yellow / Red / Yellow
	Socket		Gray / Red / Yellow
#12	Pin		Green / Blue / Orange
	Socket		Orange / Green / Orange
#12 Coax	Pin		Gray / Green / Green
	Socket		White / Green / Green
	Pin		Brown / Brown / Red
	Socket		Blue / Brown / Yellow
#10 Power	Pin		Gray / Red / Green
	Socket		Violet / Red / Green
#8 Coax	Pin		Violet / Blue / Orange
	Socket		Blue / Blue / Orange
#8 Concentric Twinax (= Triax)	Pin		White / Red / Green
	Socket		Black / Orange / Green

**Crimp contacts compatibility**

1.27µm gold plated = MIL-DTL-38999 qualified crimp contacts  
 0.8µm gold plated = SOURIAU crimp contacts

Contact plating thickness	T° cycling	Vibration			Shock	High T° exposure
		Random vib. 200°C	Sine vib. 20°C	Sine vib. 200°C		
Pin 0.8µm with Socket 1.27µm	OK	OK	-	-	-	OK
Pin 0.8µm with Socket 0.8µm	OK	OK	-	-	OK	OK
Pin 1.27µm with Socket 1.27µm	OK	OK	OK	OK	OK	OK











**SOURIAU crimp contacts - 0.8µm gold plated, without color code**

Contact size	Contact type	Part number	Contact Ø	Conductor section AWG		Conductor section mm <sup>2</sup>		External Ø over insulator							
				Min	Max	Min	Max	Min	Max						
#22D	Pin	8599-0702 JJ	0.76	26	22	0.12	0.34	0.76	1.37						
	Socket	8599-0706 900													
#20	Pin	8599-0703 SA	1.00	24	20	0.21	0.60	1.02	2.11						
	Socket	8599-0707 900													
#16	Pin	8599-0704 MJ	1.60	20	16	0.60	1.34	1.65	2.77						
	Socket	8599-0708 900													
#12	Pin	8599-0705 MJ	2.40	14	12	1.91	3.18	2.46	3.61						
	Socket	8599-0709 900													
#8 Power <small>For more information, please see p.117</small>	Pin	8599-7544	3.64	-	8	-	8.98	4.10	4.40						
	Socket	8599-7541													
	Pin	8599-7580													
	Socket	8599-7581													
	Boot	8599-4542								-	-	-	-	4.50	6.50
		8599-4547								-	-	-	-	2.50	4
	Reductor	8599-7645								10		2.73	2.77	3.13	3.33
#8 Coax	Boot	8590-4571	RG 180 A/U				-	2.80							
#8 Concentric Twinax (= Triax)	Boot	8590-4571	5.50	0,76MIL-C17/176 00002 FILECA F.2703/14 RAYCHEM CHEMINAX 10612 FILOTEX M 17/176 00002				3.15	3.40						
#4 Power <small>For more information, please see p.117</small>	Pin	8599-7598 900	5.74	-	3	-	25	-	-						
	Socket	8599-7599 900													
	Pin	8599-7534								5	4	16	21.15	-	-
	Socket	8599-7535								-	-	-	-	6.35	7.50
	Boot	8599-4594								-	-	-	-	4	5.80
		8599-4593								6		13.30		5.30	5.70
	Reductor	8593-2000A								6		13.30		5.30	5.70
#4 Power with reduced barrel	Pin	8599-7528 900	5.74	-	-	-	-	4	5.80						
	Socket	8599-7529 900													
	Boot	8599-4593													

**SOURIAU crimp contacts** - 0.8µm gold plated, without color code

Contact size	Contact type	Information
#22D	Pin	
	Socket	
#20	Pin	
	Socket	
#16	Pin	
	Socket	
#12	Pin	
	Socket	
<b>#8 Power</b> For more information, please see p.117	Pin	JVS only
	Socket	JVS only
	Pin	
	Socket	
	Boot	For wire #8
		For wire #10
Reductor	For wire #10	
<b>#8 Coax</b>	Boot	
<b>#8 Concentric Twinax (= Triax)</b>	Boot	
<b>#4 Power</b> For more information, please see p.117	Pin	For wire 21.15 mm <sup>2</sup> . Not included in connector Part number. Must be ordered separately.
	Socket	
	Pin	For wire 21.15 mm <sup>2</sup>
	Socket	
	Boot	For wire 16 mm <sup>2</sup>
		For wire 10 mm <sup>2</sup>
Reductor	For wire 10 mm <sup>2</sup>	
<b>#4 Power with reduced barrel</b>	Pin	Mating part #4 / Barrel #6
	Socket	
	Boot	

## Straight PC tail contacts

Contact size	Contact type	PC tail type	Part number	Profile
<b>#22D</b>	Pin	L	8599-0720 900	
	Pin	M	8599-8028 900	-
	Pin	C	8599-0730 900	
	Pin	S	8599-0796 900	
	Socket	L	8599-0721 900	
	Socket	C	8599-0731 900	
	Socket	S	8599-0797 900	
<b>#20</b>	Pin	M	8599-0658 JJ	-
	Socket	M	8599-0759 900	-
	Pin	C	8599-0724 900	
	Socket	C	8599-0725 900	
	Pin	L	8599-0771 900	-
	Socket	L	8599-0772 900	-
<b>#16</b>	Pin	C	8599-0726 900	
	Socket	C	8599-0727 900	
<b>Coax #16</b>	Pin	C	8599-1000A 900	
<b>#12</b>	Pin	C	8599-7929 900	-
	Socket	C	8599-7932 900	-

S: Specific PC tail  
 L: Long PC tail  
 M: Medium PC tail  
 C: Short PC tail

Note: PC tail contacts without shoulder also available. Please see page 102.

## Coax contacts #12

Designation	Part number
Coax socket solder contact #12	THA1-0151A
Coax pin solder contact#12	THA1-0152A
Coax pin crimp contact #12	THA1-0155A
Coax socket crimp contact #12	THA1-0156A

## Solder cup



Contact size	Contact type	Part number
#22D	Pin	8599-0750 900
#20	Pin	8599-0077A 900
#16	Pin	8599-7482A 900
#12	Socket	8599-7485A 900

For other contacts type please consult us.

## Crimp contacts: 1500 mating

Contact size	MIL-DTL-38999 contacts		
	Contact type	Part number	Color code
#22D	Pin (H)	M39029/107 620	Blue / Red / Black
	Socket (J)	M39029/106 614	Blue / Brown / Yellow
#20	Pin (H)	M39029/107 621	Blue / Red / Brown
	Socket (J)	M39029/106 615	Blue / Brown / Green
#16	Pin (H)	M39029/107 622	Blue / Red / Red
	Socket (J)	M39029/106 616	Blue / Brown / Blue
#12	Pin (H)	M39029/107 623	Blue / Red / Orange
	Socket (J)	M39029/106 617	Blue / Brown / Gray

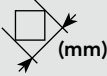





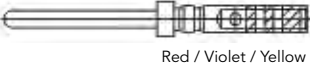

## Wire wrap contacts

Contact size	Contact type	Part number	Contact Ø (mm)	Profile	 (mm)
#22D	Pin	8599-0790 JJ	0.76		0.86
#20	Pin	8599-0791 900	1		0.86

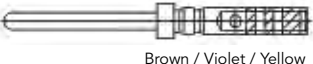
## Quadrax #8 contacts

Contact type	Version	Souriau Part Number	Cross Norm	T°	Impedance	Sealing	Release
Pin	PCB mount	ETH1-1237A	-	125°C	100Ω	Sealed	Rear
		ETH1-1501A	-		150Ω		
	Crimp	ETH1-1345A	EN3155-074	200°C	100Ω		
		ETH1-1503A	-		150Ω		
Socket	PCB mount	ETH1-1238A	-	125°C	100Ω		
		ETH1-1502A	-		150Ω		
	Crimp	ETH1-1346A	EN3155-075	200°C	100Ω		
		ETH1-1504A	-		150Ω		

## Thermocouple contacts

Contact size	Contact type	SOURIAU part numbers (without color code)	MIL-DTL-38999 contacts		Ø Contact (mm)	Wire section				Ø Over insulation (mm)	
			Part numbers	Profile and color code		Awg		mm <sup>2</sup>		min	max
						min	max	min	max		
#22D Chromel	Pin	-	M39029/87-472	 Red / Violet / Yellow	0.75	28	22	0.095	0.34	0.76	1.37
	Socket	-	M39029/88-484	 Yellow / Grey / Yellow							
#22D Alumel	Pin	-	M39029/87-471	 Brown / Violet / Yellow	0.75	28	22	0.095	0.34	0.76	1.37
	Socket	-	M39029/88-483	 Orange / Grey / Yellow							
#20 Chromel	Pin	8599-0749 900	8599-0949 900	 Blue / Violet / Yellow	1	24	20	0.21	0.6	1.02	2.11
	Socket	8599-0753 900	8599-0953 900	 Grey / Grey / Yellow							
#20 Alumel	Pin	8599-0761 900	8599-0961 900	 Green / Violet / Yellow	1	24	20	0.21	0.6	1.02	2.11
	Socket	8599-0765 900	8599-0965 900	 Violet / Grey / Yellow							

## Dummy contacts

Size	Part number
#16	8599-6A016001A
#8	8599-0308
#4	8599-0310

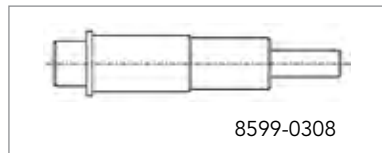

## Filler plugs

Contact size	MS Part number (Rev. N)	Color	SOURIAU Part number	Color
#22D	MS27488-22-2	Black	8660-212	Black
#20	MS27488-20-2	Red	8522-389A	Red
#16	MS27488-16-2	Green	8522-390A	Blue
#12	MS27488-12-2	Orange	8522-391A	Orange

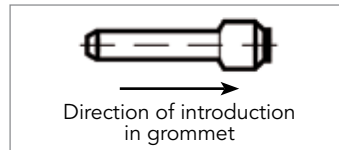

These filler plugs are installed at the rear of unwired contact to maintain connector sealing.

## Wiring instruction

### Cable preparation and wire stripping

Contact size	#26	#22D	#20	#16	#12	#8	#4
L	4		6				12

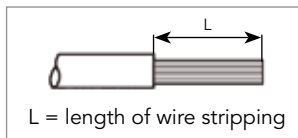

### Insertion of wire in contact barrel

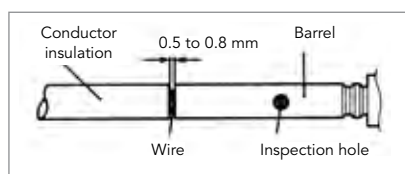

When inserting the stripped wire into the contact barrel check that no strands are left outside and that the wire is visible through the wire inspection hole in the barrel.

Important:  
 - Slide any accessories over wire strands before carrying out the following operations.  
 - Contacts are inserted and extracted from the rear of the connector.

### Insertion of the contacts

1 - Engage the crimp cable / contact assembly into the longitudinal slot of the plastic tool (coloured tip). Slide the tool down the cable until the tip of the tool abuts the contact retention shoulder.



2 - Introduce the contact into the required contact cavity in the insulator, pushing tool axially, until the contact snaps into position in clip.



3 - Withdraw the tool from rear. Check that contact is firmly locked by pulling wire gently. When connector is fully loaded, check the position of contact tips. They should all be in the same plane.  
 Nota: For larger sizes of cable which are stiff enough manual insertion without tool is preferable.

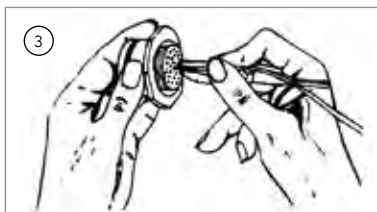

### Extraction of the contacts

1 - Engage the appropriate cable into the longitudinal slot of the tool with the white tip towards connector.



2 - Slide the tool down towards the contact. Insert the tool in the insulator until it abuts the contact shoulder.



3 - Holding the tool-contact and cable assembly together, remove them simultaneously.



## Tooling

### Crimping tools

Contact size	Contact type	Plier M22520/1-01		Plier M22520/2-01 (Souriau 8476-01)		Plier M300BT	Plier * M22520/23-01	
		Turret Part number		Locator Part number		Locator Part number	Turret Part number	Locator Part number
		Norm	Souriau	Norm	Souriau			
#26	Pin	-	-	-	8599-0397	-	-	-
	Socket	-	-	-	8599-0398	-	-	-
#22D	Pin	-	-	M22520/2-09	8476-09	-	-	-
	Socket	-	-	M22520/2-07	8476-07	-	-	-
#20	Pin	M22520/1-04	8365-04	M22520/2-10	8476-10	-	-	-
	Socket					-	-	-
#16	Pin	M22520/1-04	8365-04	-	-	-	-	-
	Socket			-	-	-	-	
#12	Pin	M22520/1-04	8365-04	-	-	-	-	-
	Socket			-	-	-	-	
#8 Power	Pin	-	-	-	-	SP 593	M22520/23-02	8599-9601
	Socket	-	-	-	-			
#4 Power	pin	-	-	-	-	-	M22520/23-04	M22520/23-11
	Socket	-	-	-	-	-		

Contact size	Contact type	Plier M22520/2-01 (Souriau 8476-01)	Plier M22520/31-01	Plier M22520/4-01	Plier M22520/5-01
		Locator Part Number	Locator Part number	Locator Part Number	Die set Part Number
#12 Coax M39029/102-558 M39029/103-559	Inner	-	-	-	M22520/5-03
	Outer	-	-	-	
#12 Coax M39029/28-211 M39029/75-416	Inner	M22520/2-34	-	-	-
	Outer	-	M22520/31-02	-	-
#16 Coax	Inner	M22520/2-35	-	-	-
	Outer	-	-	M22520/4-02	-
#8 Coax	Inner	M22520/2-31	-	-	-
	Outer	-	-	-	M22520/5-05 closure B
#8 Concentric Twinax ( = Triax )	Inner	K709	-	-	-
	Middle	-	-	-	Y631 closure B
	Ferrule	-	-	-	Y631 closure A

\* Pneumatic plier

Note: for the #10 contact's plier and locator, please consult us.



**Insertion & extraction tools**

Contact size	Material	Part number		Color	
		MIL standard	Souriau	Insertion	Extraction
#26	Plastic	-	8599-0399 900	Black	White
#22D	Plastic	M81969/14-01	-	Green	White
#20	Plastic	M81969/14-10	-	Red	Orange
#16	Plastic	M81969/14-03	-	Blue	White
#12	Plastic	M81969/14-04	-	Yellow	White
#10	Plastic	M81969/14-05	-	Grey	-
#8	Plastic	M81969/14-12	-	-	Green
	Metallic	-	8660-197	-	-
#4	Plastic	M81969/14-07	-	-	Blue
	Metallic	-	8533-8175	-	-

**Backshell tightening tools**



Backshell tightening pliers,  
part number: 8498-03  
Square jaws (order 2 jaws),  
part number: 8500-1015

**Tightening support**

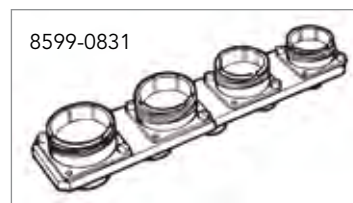

Part number: 8599-0831  
This tool is made up of dummy receptacle housings of all 9 sizes for all key polarisation, and secures free connectors during wiring and fitting of rear accessories.

**Tightening of rear accessories:**

Shell size	9	11	13	15	17	19	21	23	25
Max torque in m/daN	0.62						1.24		

**Slackening tools**



Strap clamp,  
part number: 8498-04  
Spare strap,  
part number: 8498-103

## Accessories

### Plastic protective caps\*

Shell size	Caps for receptacles	Caps for plugs	Caps for composite plugs only (J & M)	Antistatic caps for receptacles	Antistatic caps for plugs	Antistatic caps for composite plugs only (J & M)
9 (A)	MS90376-10R	8500-5587 A	MS90376-12R	MS90376-10RF	8500-5587N	8500-5587N
11 (B)	MS90376-12R	8500-5588A	8500-5598	MS90376-12RF	70198N	8500-5598N
13 (C)	MS90376-14R	8500-5600	8500-5600	MS90376-14RF	8500-5600N	8500-5600N
15 (D)	MS90376-16R	8500-5601	8500-5601	MS90376-16RF	8500-5601N	8500-5601N
17 (E)	MS90376-19R	8500-5602	8500-5602	MS90376-18RF	8500-5602N	8500-5602N
19 (F)	MS90376-20R	8500-5592 A	8500-5592 A	MS90376-20RF	8500-5592N	8500-5592N
21 (G)	MS90376-22R	8500-5593 A	8500-5593 A	MS90376-22RF	8500-5593N	8500-5593N
23 (H)	MS90376-24R	8500-5593 A	MS90376-28R	MS90376-24RF	8500-5593N	70472N
25 (J)	8599-0029	J599ABC6009A00	J599ABC6009A00	8500-5593N	MS90376-28RF	MS90376-28RF

\* Excepted 8D composite version (X): supplied without cap

### Gaskets

Shell size	Gasket for receptacles Type 0* (ordered separately)	O ring for receptacle Type 7
9 (A)	8599-5541	AS3582-019
11 (B)	8599-5542	AS3582-022
13 (C)	8599-5543	AS3582-024
15 (D)	8599-5544	AS3582-026
17 (E)	8599-5545	AS3582-028
19 (F)	8599-5546	AS3582-128
21 (G)	8599-5547	AS3582-130
23 (H)	8599-5548	AS3582-132
25 (J)	8599-5549	AS3582-134

\* For front mounting

### Orientations

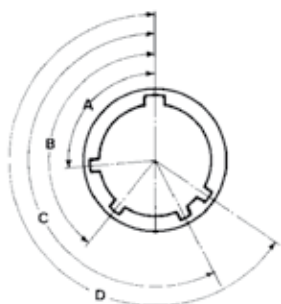

Viewed from front face of receptacle

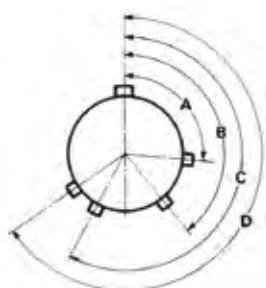

Viewed from front face of plug

Shell size	Angles	N	A	B	C	D	E	T	V
9 (A)	A°	105	102	80	35	64	91	-	-
	B°	140	132	118	140	155	131	-	-
	C°	215	248	230	205	234	197	-	-
	D°	265	320	312	275	304	240	-	-
11 (B) 15 (D)	A°	95	113	90	53	119	51	-	-
	B°	141	156	145	156	146	141	-	-
	C°	208	182	195	220	176	184	-	-
	D°	236	292	252	255	298	242	-	-
13 (C)	A°	95	113	90	53	119	51	70	75
	B°	141	156	145	156	146	141	136	138
	C°	208	182	195	220	176	184	218	224
	D°	236	292	252	255	298	242	261	268
17 (E) 21 (G)	A°	80	135	49	66	62	79	58	85
	B°	142	170	169	140	145	153	162	150
	C°	196	200	200	200	180	197	188	191
	D°	293	310	244	257	280	272	316	307
19 (F) 23 (H) 25 (J)	A°	80	135	49	66	62	79	-	-
	B°	142	170	169	140	145	153	-	-
	C°	196	200	200	200	180	197	-	-
	D°	293	310	244	257	280	272	-	-

### Panel cut-out

Square flange receptacle (Type 0)

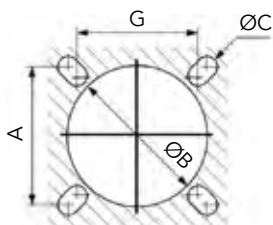

Rear mounting\*

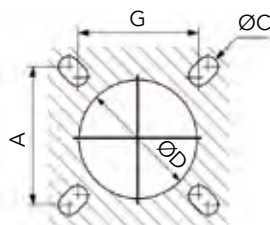

Front mounting

Jam nut receptacle (Type 7)

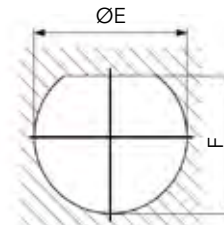

Shell size	A	G	B min.	C ±0.13	D min.	E +0.25	F
9 (A)	18.26	15.09	16.66	3.25	13.11	17.78	17.02
11 (B)	20.62	18.26	20.22		15.88	20.96	19.59
13 (C)	23.01	20.62	23.42		19.05	25.65	24.26
15 (D)	24.61	23.01	26.59		23.01	28.83	27.56
17 (E)	26.97	24.61	30.96		25.81	32.01	30.73
19 (F)	29.36	26.97	32.94		28.98	35.18	33.91
21 (G)	31.75	29.36	36.12	3.91	32.16	38.35	37.08
23 (H)	34.93	31.75	39.29		34.93	41.53	40.26
25 (J)	38.10	34.94	42.47*		37.69	44.70	43.43

\* For Type 0 composite shell rear mounting: 43.77 mm.

Max. thickness panel for receptacle: Type 0: front mounting = 3.2 mm, rear mounting = 2.5 mm  
Type 7: 3.2 mm

## Coordinates for straight PC tail terminations Viewed from front face of male insulator

Hole sizes: 1mm min. (#22 and #20 contacts) and 1.3mm min. (#16 contact) coordinates in mm.

### 09 / A

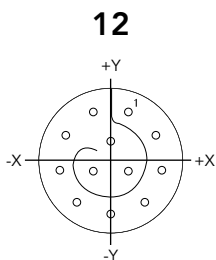

Ctc	X	Y	Ctc	X	Y
1	+0.92	+2.54	7	-2.66	-0.47
2	+2.34	+1.35	8	-2.34	+1.35
3	+2.66	-0.47	9	-0.92	+2.54
4	+1.74	-2.07	10	0.00	+1.03
5	0.00	-2.70	11	+0.89	-0.51
6	-1.74	-2.07	12	-0.89	-0.51

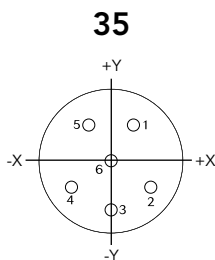

Ctc	X	Y	Ctc	X	Y
1	+1.14	+1.98	5	-1.14	+1.98
2	+1.98	-1.14	6	0.00	0.00
3	0.00	-2.29			
4	-1.98	-1.14			

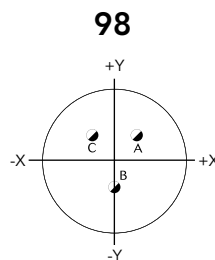

Ctc	X	Y
A	+1.65	+0.97
B	0.00	-1.90
C	-1.65	+0.97

### 11 / B

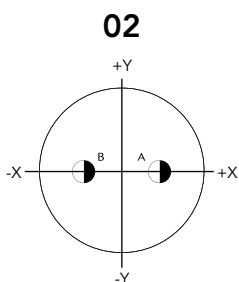

Ctc	X	Y
A	0.00	+2.41
B	0.00	-2.41

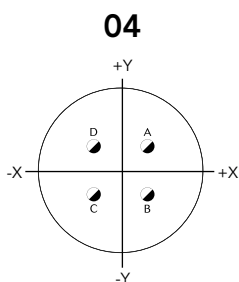

Ctc	X	Y
A	+1.65	+1.65
B	+1.65	-1.65
C	-1.65	-1.65
D	-1.65	+1.65

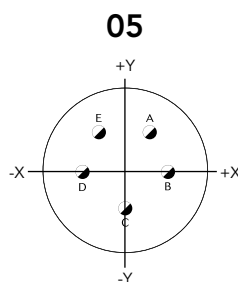

Ctc	X	Y
A	+1.65	+1.42
B	+2.86	-1.65
C	0.00	-3.30
D	-2.86	-1.65
E	-1.65	+1.42

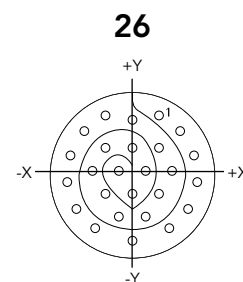

Ctc	X	Y	Ctc	X	Y
1	+1.69	+3.79	14	0.00	+3.50
2	+3.09	+2.77	15	+1.70	+1.76
3	+3.95	+1.28	16	+2.55	+0.29
4	+4.13	-0.44	17	+1.70	-1.18
5	+3.58	-2.10	18	+0.85	-2.65
6	+2.40	-3.37	19	-0.85	-2.65
7	0.00	-4.13	20	-1.70	-1.18
8	-2.40	-3.37	21	-2.55	+0.29
9	-3.58	-2.10	22	-1.70	+1.76
10	-4.13	-0.44	23	0.00	+1.76
11	-3.95	+1.28	24	+0.85	+0.29
12	-3.09	+2.77	25	0.00	-1.18
13	-1.69	+3.79	26	-0.85	+0.29

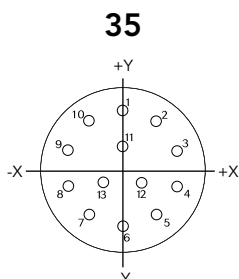

Ctc	X	Y	Ctc	X	Y	Ctc	X	Y
1	0.00	+3.71	6	0.00	-3.71	10	-2.16	+3.00
2	+2.16	+3.00	7	-2.16	-3.00	11	0	+1.42
3	+3.51	+1.14	8	-3.51	-1.14	12	+1.24	-0.89
4	+3.51	-1.14	9	-3.51	+1.14	13	-1.24	-0.89
5	+2.16	-3.00						

11 / B

98

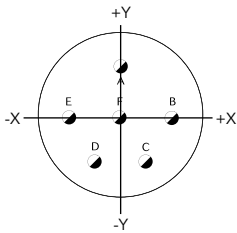

Ctc	X	Y
A	0.00	+3.30
B	+3.30	0.00
C	+1.65	-2.87
D	-1.65	-2.87
E	-3.30	0.00
F	0.00	0.00

99

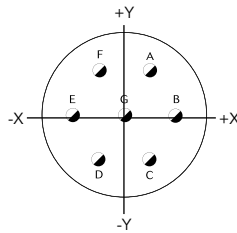

Ctc	X	Y
A	+1.65	+2.85
B	+3.30	0.00
C	+1.65	-2.87
D	-1.65	-2.87
E	-3.30	0.00
F	-1.65	+2.87
G	0.00	0.00

13 / C

04

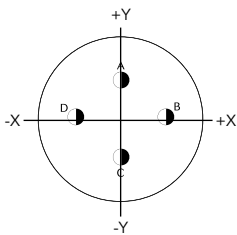

Ctc	X	Y
A	0.00	+3.81
B	+3.71	+0.89
C	0.00	-2.11
D	-3.71	+0.89

08

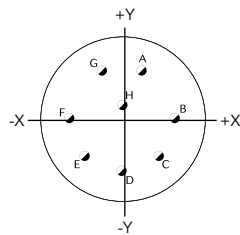

Ctc	X	Y
A	+1.65	+3.99
B	+4.32	0.00
C	+3.05	-3.05
D	0.00	-4.32
E	-3.05	-3.05
F	-4.32	0.00
G	-1.65	+3.99
H	0.00	+1.12

35

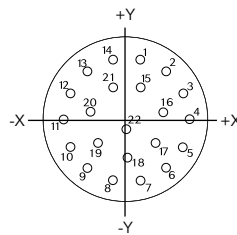

Ctc	X	Y	Ctc	X	Y
1	+1.14	+5.00	12	-4.62	+2.24
2	+3.20	+4.01	13	-3.20	+4.01
3	+4.62	+2.24	14	-1.14	+5.00
4	+5.16	0.00	15	+1.14	+2.72
5	+4.62	-2.24	16	+2.97	+0.66
6	+3.20	-4.01	17	+2.36	-1.91
7	+1.14	-5.00	18	0.00	-3.05
8	-1.14	-5.00	19	-2.36	-1.91
9	-3.20	-4.01	20	-2.97	+0.66
10	-4.62	-2.24	21	-1.14	+2.72
11	-5.16	0.00	22	0.00	-0.76

43

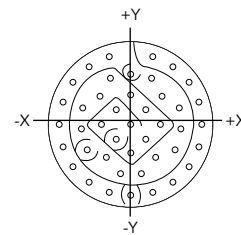

Ctc	X	Y	Ctc	X	Y
1	+1.80	+5.54	23	+3.92	+1.27
2	-1.80	+5.54	24	+4.10	-0.43
3	+3.42	+4.71	25	+3.57	-2.06
4	+4.71	+3.42	26	+1.99	-2.74
5	+5.54	+1.80	27	+0.86	-4.03
6	+5.82	0.00	28	-0.86	-4.03
7	+5.54	-1.80	29	-1.99	-2.74
8	+4.71	-3.42	30	-3.57	-2.06
9	+3.42	-4.71	31	-4.10	-0.43
10	+1.80	-5.54	32	-3.92	+1.27
11	0.00	-5.82	33	-2.54	+2.28
12	-1.80	-5.54	34	-1.68	+3.76
13	-3.42	-4.71	35	0.00	+2.42
14	-4.71	-3.42	36	+1.21	+1.21
15	-5.54	-1.80	37	+2.42	0.00
16	-5.82	0.00	38	+1.21	-1.21
17	-5.54	+1.80	39	0.00	-2.42
18	-4.71	+3.42	40	-1.21	-1.21
19	-3.42	+4.71	41	-2.42	0.00
20	0.00	+4.12	42	-1.21	+1.21
21	+1.68	+3.76	43	0.00	0.00
22	+2.54	+2.28			

98

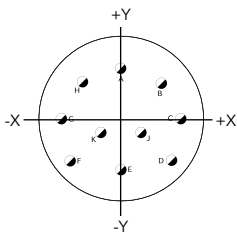

Ctc	X	Y	Ctc	X	Y
A	0.00	+4.95	F	-4.17	-2.67
B	+3.18	+3.81	G	-4.90	+0.76
C	+4.90	+0.76	H	-3.18	+3.81
D	+4.17	-2.67	J	+1.65	-0.38
E	0.00	-3.43	K	-1.65	-0.38

15 / D

05

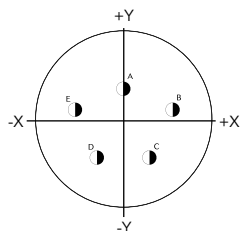

Ctc	X	Y
A	0	+2.54
B	+4.42	+0.61
C	+2.39	+3.76
D	-2.39	-3.76
E	-4.42	+0.61

18

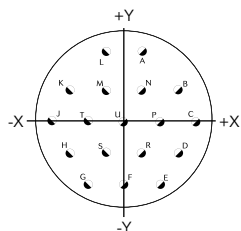

Ctc	X	Y
A	+1.65	+6.40
B	+4.95	+2.87
C	+6.60	0.00
D	+4.95	-2.87
E	+3.30	-5.72
F	0.00	-5.72
G	-3.30	-5.72
H	-4.95	-2.87
J	-6.60	0.00
K	-4.95	+2.87
L	-1.65	+6.40
M	-1.65	+2.87
N	+1.65	+2.87
P	+3.30	0.00
R	+1.65	-2.87
S	-1.65	-2.87
T	-3.30	0.00
U	0.00	0.00

19

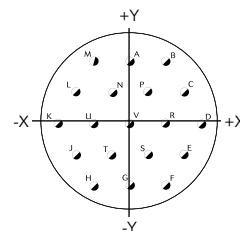

Ctc	X	Y
A	0.00	+5.72
B	+3.30	+5.72
C	+4.95	+2.87
D	+6.60	0.00
E	+4.95	-2.87
F	+3.30	-5.72
G	0.00	-5.72
H	-3.30	-5.72
J	-4.95	-2.87
K	-6.60	0.00
L	-4.95	+2.87
M	-3.30	+5.72
N	-1.65	+2.87
P	+1.65	+2.87
R	+3.30	0.00
S	+1.65	-2.87
T	-1.65	-2.87
U	-3.30	0.00
V	0.00	0.00

97

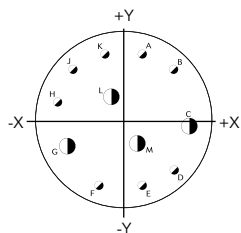

Ctc	X	Y
A	+1.65	+5.94
B	+4.52	+4.52
C	+5.84	-0.58
D	+4.52	-4.52
E	+1.65	-5.94
F	-2.26	-5.97
G	-5.26	-2.41
H	-5.94	+1.65
J	-4.52	+4.52
K	-1.65	+5.94
L	-1.19	+2.06
M	+1.19	-2.06

35

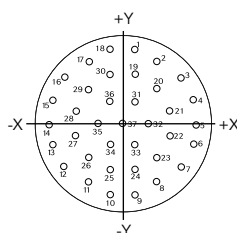

Ctc	X	Y
1	+1.14	+6.65
2	+3.12	+5.51
3	+5.36	+4.06
4	+6.45	+2.03
5	+6.75	-0.25
6	+6.27	-2.49
7	+5.08	-4.45
8	+3.30	-5.89
9	+1.14	-6.65
10	-1.14	-6.65
11	-3.30	-5.89
12	-5.08	-4.45
13	-6.27	-2.49
14	-6.76	-0.25
15	-6.45	+2.03
16	-5.36	+4.06
17	-3.12	+5.51
18	-1.14	+6.65
19	+1.14	+4.37
20	+3.12	+3.02
21	+4.32	+1.02
22	+4.32	-1.27
23	+3.12	-3.23
24	+1.14	-4.37
25	-1.14	-4.37
26	-3.12	-3.23
27	-4.32	-1.27
28	-4.32	+1.02
29	-3.12	+3.02
30	-1.14	+4.37
31	+1.14	+1.88
32	+2.29	-0.10
33	+1.14	-2.08
34	-1.14	-2.08
35	-2.29	-0.10
36	-1.14	+1.88
37	0.00	-0.10

17 / E

06

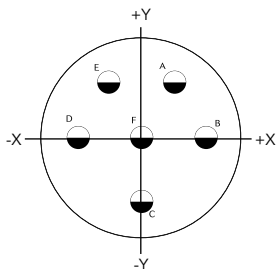

Ctc	X	Y
A	+3.07	+5.31
B	+6.12	0.00
C	0.00	-6.12
D	-6.12	0.00
E	-3.07	+5.31
F	0.00	0.00

08

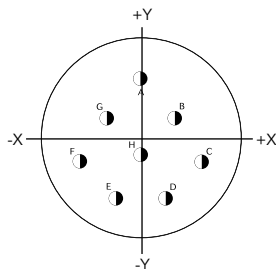

Ctc	X	Y
A	0.00	+5.99
B	+3.25	+2.18
C	+5.84	-1.98
D	+2.39	-5.49
E	-2.39	-5.49
F	-5.84	-1.98
G	-3.25	+2.18
H	0.00	-1.32

26

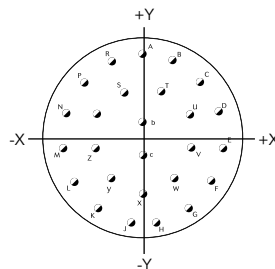

Ctc	X	Y
A	0.00	+8.15
B	+3.33	+7.44
C	+6.07	+5.44
D	+7.75	+2.51
E	+8.10	-0.86
F	+7.06	-4.09
G	+4.80	-6.60
H	+1.70	-7.98

Ctc	X	Y
J	-1.70	-7.98
K	-4.80	-6.60
L	-7.06	-4.09
M	-8.10	-0.86
N	-7.75	+2.51
P	-6.07	+5.44
R	-3.33	+7.44
S	-1.78	+4.50
T	+1.78	+4.50
U	+4.45	+2.39
V	+4.53	-0.91
W	+3.02	-3.84
X	0.00	-5.16
Y	-3.02	-3.84
Z	-4.53	-0.91
a	-4.45	+2.39
b	0.00	+1.65
c	0.00	-1.65

35

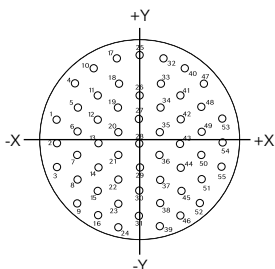

Ctc	X	Y	Ctc	X	Y
1	-7.92	+2.18	13	-3.96	-0.10
2	-7.92	-0.10	14	-3.96	-2.39
3	-7.92	-2.39	15	-3.96	-4.67
4	-6.15	+5.61	16	-3.96	-6.96
5	-5.94	+3.33	17	-2.26	+8.03
6	-5.94	+1.04	18	-1.98	+5.61
7	-5.94	-1.24	19	-1.98	+3.33
8	-5.94	-3.53	20	-1.98	+1.04
9	-5.94	-5.82	21	-1.98	-1.24
10	-4.37	+7.09	22	-1.98	-3.53
11	-3.96	+4.47	23	-1.98	-5.82
12	-3.96	+2.18	24	-1.98	-8.10

Ctc	X	Y	Ctc	X	Y
25	0.00	+8.36	41	+3.96	+4.47
26	0.00	+4.47	42	+3.96	+2.18
27	0.00	+2.18	43	+3.96	-0.10
28	0.00	-0.10	44	+3.96	-2.39
29	0.00	-2.39	45	+3.96	-4.67
30	0.00	+4.67	46	+3.96	-6.96
31	0.00	-6.96	47	+6.15	+5.61
32	+2.26	+8.03	48	+5.94	+3.33
33	+1.98	+5.61	49	+5.94	+1.04
34	+1.98	+3.33	50	+5.94	-1.24
35	+1.98	+1.04	51	+5.94	-3.53
36	+1.98	-1.24	52	+5.94	-5.82
37	+1.98	-3.53	53	+7.92	+2.18
38	+1.98	-5.82	54	+7.92	-0.10
39	+1.98	-8.10	55	+7.92	-2.39
40	+4.37	+7.09			

99

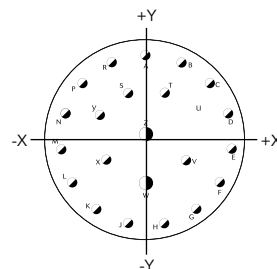

Ctc	X	Y	Ctc	X	Y
A	0.00	+8.15	N	-7.75	+2.51
B	+3.33	+7.44	P	-6.07	+5.44
C	+6.07	+5.44	R	-3.33	+7.44
D	+7.75	+2.51	S	-1.78	+4.50
E	+8.10	-0.86	T	+1.78	+4.50
F	+7.06	-4.09	U	+4.45	+2.39
G	+4.80	-6.60	V	+3.81	-1.91
H	+1.70	-7.98	W	0.00	-4.09
J	-1.70	-7.98	X	-3.81	-1.91
K	-4.80	-6.60	Y	-4.45	+2.39
L	-7.06	-4.09	Z	0.00	+0.64
M	-8.10	-0.86			

19 / F

11

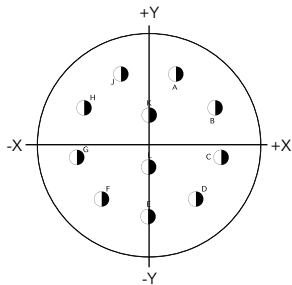

Ctc	X	Y
A	+2.67	+6.60
B	+6.35	+3.35
C	+6.99	-1.35
D	+4.55	-5.46
E	0.00	-7.14
F	-4.55	-5.46
G	-6.99	-1.35
H	-6.35	+3.35
J	-2.67	+6.60
K	0.00	+2.67
L	0.00	-2.34

32

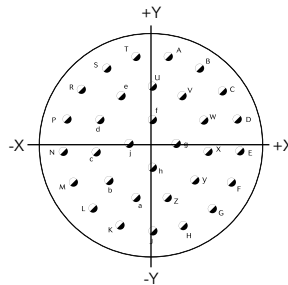

Ctc	X	Y
A	+1.68	+8.97
B	+4.80	+7.75
C	+7.26	+5.51
D	+8.76	+2.49
E	+9.07	-0.84
F	+8.15	-4.06
G	+6.15	-6.73
H	+3.30	-8.51
J	0.00	-9.12
K	-3.30	-8.51
L	-6.15	-6.73
M	-8.15	-4.06
N	-9.07	-0.84
P	-8.76	+2.49
R	-7.26	+5.51
S	-4.80	+7.75

Ctc	X	Y
T	-1.68	+8.97
U	0.00	+5.84
V	+3.15	+4.90
W	+5.31	+2.41
X	+5.79	-0.84
Y	+4.42	-3.84
Z	+1.65	-5.61
a	-1.65	-5.61
b	-4.42	-3.84
c	-5.79	-0.84
d	-5.31	+2.41
e	-3.15	+4.90
f	0.00	+2.44
g	+2.44	0.00
h	0.00	-2.44
j	-2.44	0.00

35

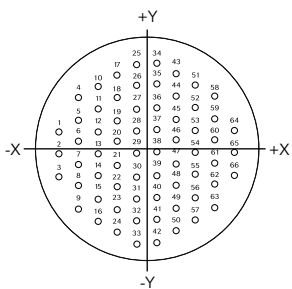

Ctc	X	Y
1	-9.07	+2.29
2	-9.07	0.00
3	-9.07	-2.29
4	-7.09	+5.71
5	-7.09	+3.43
6	-7.09	+1.14
7	-7.09	-1.14
8	-7.09	-3.43
9	-7.09	-5.71
10	-5.11	+6.86
11	-5.11	+4.57
12	-5.11	+2.29
13	-5.11	0.00
14	-5.11	-2.29

Ctc	X	Y
15	-5.11	-4.57
16	-5.11	-6.86
17	-3.12	+8.00
18	-3.12	+5.71
19	-3.12	+3.43
20	-3.12	+1.14
21	-3.12	-1.14
22	-3.12	-3.43
23	-3.12	-5.71
24	-3.12	-8.00
25	-1.14	+9.14
26	-1.14	+6.86
27	-1.14	+4.57

Ctc	X	Y
28	-1.14	+2.29
29	-1.14	0.00
30	-1.14	-2.29
31	-1.14	-4.57
32	-1.14	-6.86
33	-1.14	-9.14
34	+1.14	+9.14
35	+1.14	+6.86
36	+1.14	+4.57
37	+1.14	+2.29
38	+1.14	0.00
39	+1.14	-2.29
40	+1.14	-4.57

Ctc	X	Y
41	+1.14	-6.86
42	+1.14	-9.14
43	+3.12	+8.00
44	+3.12	+5.71
45	+3.12	+3.43
46	+3.12	+1.14
47	+3.12	-1.14
48	+3.12	-3.43
49	+3.12	-5.71
50	+3.12	-8.00
51	+5.11	+6.86
52	+5.11	+4.57
53	+5.11	+2.29

Ctc	X	Y
54	+5.11	0.00
55	+5.11	-2.29
56	+5.11	-4.57
57	+5.11	-6.86
58	+7.09	+5.71
59	+7.09	+3.43
60	+7.09	+1.14
61	+7.09	-1.14
62	+7.09	-3.43
63	+7.09	-5.71
64	+9.07	+2.29
65	+9.07	0.00
66	+9.07	-2.29



21 / G

16

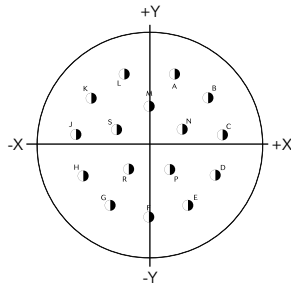

Ctc	X	Y	Ctc	X	Y
A	+3.00	+8.18	J	-8.66	+0.91
B	+6.88	+5.36	K	-6.88	+5.36
C	+8.66	+0.91	L	-3.00	+8.18
D	+7.82	-3.81	M	0.00	+4.45
E	+4.62	-7.37	N	+3.91	+1.57
F	0.00	-8.71	P	+2.39	-3.10
G	-4.62	-7.37	R	-2.39	-3.10
H	-7.82	-3.81	S	-3.91	+1.57

35

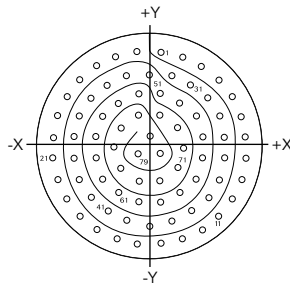

Ctc	X	Y
1	+1.35	+10.82
2	+3.71	+10.26
3	+5.89	+9.19
4	+7.77	+7.67
5	+9.27	+5.77
6	+10.31	+3.58
7	+10.85	+1.22
8	+10.85	-1.22
9	+10.31	-3.58
10	+9.27	-5.77
11	+7.77	-7.67
12	+5.89	-9.19
13	+3.71	-10.26

Ctc	X	Y	Ctc	X	Y	Ctc	X	Y
14	+1.35	-10.82	36	+7.90	-3.58	58	+3.40	-5.05
15	-1.35	-10.82	37	+6.55	-5.59	59	+1.22	-6.12
16	-3.71	-10.26	38	+4.67	-7.11	60	-1.22	-6.12
17	-5.89	-9.19	39	+2.49	-8.18	61	-3.40	-5.05
18	-7.77	-7.67	40	0.00	-8.81	62	-5.28	-3.53
19	-9.27	-5.77	41	-2.49	-8.18	63	-6.02	-1.22
20	-10.31	-3.58	42	-4.67	-7.11	64	-6.02	+1.22
21	-10.85	-1.22	43	-6.55	-5.59	65	-5.28	+3.53
22	-10.85	+1.22	44	-7.90	-3.58	66	-3.40	+5.05
23	-10.31	+3.58	45	-8.43	-1.22	67	-1.22	+3.71
24	-9.27	+5.77	46	-8.43	+1.22	68	+1.22	+3.71
25	-7.77	+7.67	47	-7.90	+3.58	69	+3.18	+2.29
26	-5.89	+9.19	48	-6.55	+5.59	70	+3.94	0.00
27	-3.71	+10.26	49	-4.67	+7.11	71	+3.18	-2.29
28	-1.35	+10.82	50	-2.49	+8.18	72	+1.22	-3.71
29	0.00	+8.20	51	-1.22	+6.12	73	-1.22	-3.71
30	+2.49	+8.18	52	+1.22	+6.12	74	-3.18	-2.29
31	+4.67	+7.11	53	+3.40	+5.05	75	-3.94	0.00
32	+6.55	+5.59	54	+5.28	+3.53	76	-3.18	+2.29
33	+7.90	+3.58	55	+6.02	+1.22	77	0.00	+1.35
34	+8.43	+1.22	56	+6.02	-1.22	78	+1.22	-0.74
35	+8.43	-1.22	57	+5.28	-3.53	79	-1.22	-0.74

39

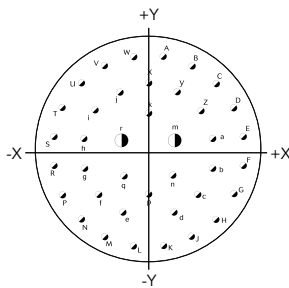

Ctc	X	Y	Ctc	X	Y	Ctc	X	Y
A	+1.65	+10.44	P	-9.42	-4.80	d	+2.84	-6.73
B	+4.80	+9.42	R	-10.44	-1.65	e	-2.84	-6.73
C	+7.47	+7.47	S	-10.44	+1.65	f	-5.51	-4.80
D	+9.42	+4.80	T	-9.42	+4.80	g	-7.11	-1.88
E	+10.44	+1.65	U	-7.47	+7.47	h	-7.11	+1.45
F	+10.44	-1.65	V	-4.80	+9.42	i	-5.89	+4.55
G	+9.42	-4.80	W	-1.65	+10.44	j	-3.20	+6.50
H	+7.47	-7.47	X	0.00	+7.49	k	0.00	+4.17
J	+4.80	-9.42	Y	+3.20	+6.50	m	+2.90	+1.22
K	+1.65	-10.44	Z	+5.89	+4.55	n	+2.69	-2.72
L	-1.65	-10.44	a	+7.11	+1.45	p	0.00	-4.80
M	-4.80	-9.42	b	+7.11	-1.88	q	-2.69	-2.72
N	-7.47	-7.47	c	+5.51	-4.80	r	-2.90	+1.22

41

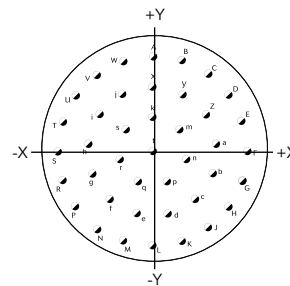

Ctc	X	Y	Ctc	X	Y
A	0.00	+10.60	M	-3.26	-10.09
B	+3.28	+10.09	N	-6.23	-8.58
C	+6.23	+8.58	P	-8.58	-6.23
D	+8.58	+6.23	R	-10.09	-3.28
E	+10.09	+3.28	S	-10.60	0.00
F	+10.60	0.00	T	-10.09	+3.28
G	+10.09	-3.28	U	-8.58	+6.23
H	+8.58	-6.23	V	-6.23	+8.58
J	+6.23	-8.58	W	-3.28	+10.09
K	+3.28	-10.09	X	0.00	+7.20
L	0.00	-10.60	Y	+3.35	+6.38

Ctc	X	Y
Z	+5.92	+4.09
a	+7.15	+0.87
b	+6.73	-2.55
c	+4.78	-5.39
d	+1.73	-6.99
e	-1.73	-6.99
f	-4.78	-5.39
g	-6.73	-2.55
h	-7.15	+0.87
i	-5.92	+4.09
j	-3.35	+6.38
k	0.00	+3.81
m	+2.98	+2.38
n	+3.71	-0.85
p	-1.66	-3.43
q	+1.66	-3.43
r	-3.71	-0.85
s	-2.98	+2.38
t	0.00	0.00

23 / H

21

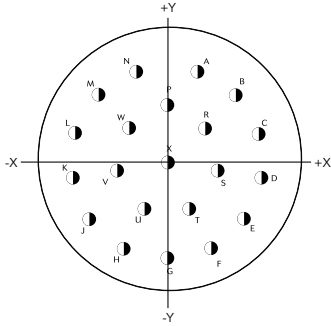

Ctc	X	Y
A	+3.25	+9.78
B	+7.34	+7.24
C	+9.80	+3.12
D	+10.16	-1.65
E	+8.33	-6.07
F	+4.65	-9.19
G	0.00	-10.31
H	-4.65	-9.19
J	-8.33	-6.07
K	-10.16	-1.65
L	-9.80	+3.12
M	-7.34	+7.24
N	-3.25	+9.78
P	0.00	+6.22
R	+4.06	+3.71
S	+5.44	-0.89
T	+2.39	-4.93
U	-2.39	-4.93
V	-5.44	-0.89
W	-4.06	+3.71
X	0.00	0.00

53

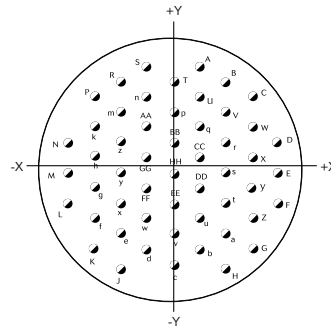

Ctc	X	Y
A	+2.84	+11.56
B	+5.72	+9.91
C	+8.53	+8.26
D	+11.43	+3.30
E	+11.43	0.00
F	+11.43	-3.30

Ctc	X	Y
G	+8.53	-8.26
H	+5.72	-10.41
J	-5.72	-10.41
K	-8.53	-8.26
L	-11.43	-3.30
M	-11.43	0.00

Ctc	X	Y
N	-11.43	+3.30
P	-8.53	+8.26
R	-5.72	+9.91
S	-2.84	+11.56
T	0.00	+9.91
U	+2.84	+8.26
V	+5.72	+6.60
W	+8.53	+4.95
X	+8.53	+1.65
Y	+8.53	-1.65
Z	+8.53	-4.95
a	+5.72	-6.60
b	+2.84	-8.26
c	0.00	-9.91
d	-2.84	-8.26
e	-5.72	-6.60
f	-8.53	-4.95
g	-8.53	-1.65
h	-8.53	+1.65
k	-8.53	+4.95

Ctc	X	Y
m	-5.72	+6.60
n	-2.84	+8.26
p	0.00	+6.60
q	+2.84	+4.95
r	+5.72	+3.30
s	+5.72	0.00
t	+5.72	-3.30
u	+2.84	-4.95
v	0.00	-6.60
w	-2.84	-4.95
x	-5.72	-3.30
y	-5.72	0.00
z	-5.72	+3.30
AA	-2.84	+4.95
BB	0.00	+3.30
CC	+2.84	+1.65
DD	+2.84	-1.65
EE	0.00	-3.30
FF	-2.84	-1.65
GG	-2.84	+1.65
HH	0.00	0.00

25 / J

04

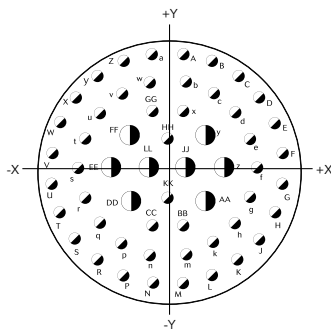

Ctc	X	Y	Ctc	X	Y
A	+1.75	+13.49	H	+12.52	-5.21
B	+5.16	+12.57	J	+10.77	-8.28
C	+8.23	+10.80	K	+8.23	-10.80
D	+10.77	+8.28	L	+5.16	-12.57
E	+12.52	+5.21	M	+1.75	-13.49
F	+13.49	+1.75	N	-1.75	-13.49
G	+13.49	-1.75	P	-5.16	-12.57

Ctc	X	Y
R	-8.23	-10.80
S	-10.77	-8.28
T	-12.52	-5.21
U	-13.49	-1.75
V	-13.49	+1.75
W	-12.52	+5.21
X	-10.77	+8.28
Y	-8.23	+10.80
Z	-5.16	+12.57
a	-1.75	+13.49
b	+2.18	+10.08
c	+5.38	+8.78
d	+7.90	+6.38
e	+9.58	+3.35
f	+10.46	0.00
g	+9.58	-3.35
h	+7.90	-6.38
k	+5.38	-8.78
m	+2.18	-10.08
n	-2.18	-10.08
p	-5.38	-8.78

Ctc	X	Y
q	-7.90	-6.38
r	-9.58	-3.35
s	-10.46	0.00
t	-9.58	+3.35
u	-7.90	+6.38
v	-5.38	+8.78
w	-2.18	+10.08
x	+1.75	+6.66
y	+4.37	+3.78
z	+6.55	0.00
AA	+4.37	-3.78
BB	+1.75	-6.66
CC	-1.75	-6.66
DD	-4.37	-3.78
EE	-6.55	0.00
FF	-4.37	-3.78
GG	-1.75	-6.66
HH	0.00	+3.35
JJ	+2.18	0.00
KK	0.00	-3.35
LL	-2.18	0.00

29

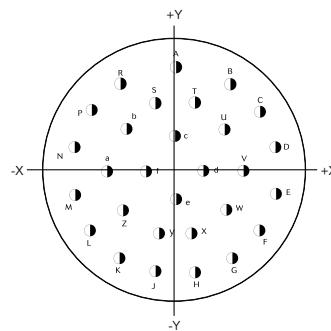

Ctc	X	Y
A	0.00	+12.22
B	+6.55	+10.31
C	+10.03	+7.04
D	+11.91	+2.77
E	+11.91	-2.77
F	+10.03	-7.04
G	+6.68	-10.31
H	+2.31	-11.99

Ctc	X	Y
J	-2.31	-11.99
K	-6.68	-10.31
L	-10.03	-7.04
M	-11.91	-2.77
N	-11.91	+2.77
P	-10.03	+7.04
R	-6.55	+10.31
S	-2.31	+8.15
T	+2.31	+8.15
U	+5.79	+4.93
V	+8.10	0.00
W	+6.10	-4.60
X	+2.31	-7.37
Y	-2.31	-7.37
Z	-6.10	-4.60
a	-8.10	0.00
b	-5.79	+4.93
c	0.00	+4.09
d	+3.40	0.00
e	0.00	-3.30
f	-3.40	0.00

25 / J

35

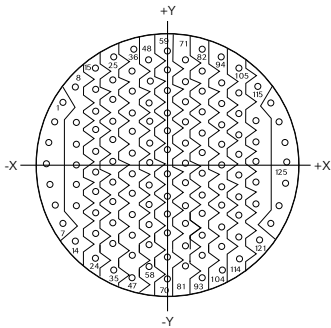

Ctc	X	Y
1	-12.17	+7.09
2	-13.21	+4.83
3	-13.87	+2.41
4	-14.10	0.00
5	-13.87	-2.41
6	-13.21	-4.83
7	-12.17	-7.09
8	-10.77	+9.07
9	-10.54	+4.83
10	-10.54	+2.41
11	-10.54	0.00
12	-10.54	-2.41
13	-10.54	-4.83
14	-10.77	-9.07
15	-8.43	+11.28
16	-8.43	+8.43
17	-8.43	+6.02
18	-8.43	+3.61
19	-8.43	+1.19
20	-8.43	-1.19
21	-8.43	-3.61
22	-8.43	-6.02
23	-8.43	-8.43
24	-8.43	-10.85
25	-6.32	+12.60
26	-6.32	+9.65

Ctc	X	Y
27	-6.32	+7.24
28	-6.32	+4.83
29	-6.32	+2.41
30	-6.32	0.00
31	-6.32	-2.41
32	-6.32	-4.83
33	-6.32	-7.24
34	-6.32	-9.65
35	-6.32	-12.07
36	-4.06	+13.49
37	-4.22	+10.85
38	-4.22	+8.43
39	-4.22	+6.02
40	-4.22	+3.61
41	-4.22	+1.19
42	-4.22	-1.19
43	-4.22	-3.61
44	-4.22	-6.02
45	-4.22	-8.43
46	-4.22	-10.85
47	-4.22	-13.26
48	-2.11	+12.07
49	-2.11	+9.65
50	-2.11	+7.24
51	-2.11	+4.83
52	-2.11	+2.41

Ctc	X	Y
53	-2.11	0.00
54	-2.11	-2.41
55	-2.11	-4.83
56	-2.11	-7.24
57	-2.11	-9.65
58	-2.11	-12.07
59	0.00	+13.26
60	0.00	+10.85
61	0.00	+8.43
62	0.00	+6.02
63	0.00	+3.61
64	0.00	+1.19
65	0.00	-1.19
66	0.00	-3.61
67	0.00	-6.02
68	0.00	-8.43
69	0.00	-10.85
70	0.00	-14.10
71	+2.11	+12.07
72	+2.11	+9.65
73	+2.11	+7.24
74	+2.11	+4.83
75	+2.11	+2.41
76	+2.11	0.00
77	+2.11	-2.41
78	+2.11	-4.83

Ctc	X	Y
79	+2.11	-7.24
80	+2.11	-9.65
81	+2.11	-12.07
82	+4.06	+13.49
83	+4.22	+10.85
84	+4.22	+8.43
85	+4.22	+6.02
86	+4.22	+3.61
87	+4.22	+1.19
88	+4.22	-1.19
89	+4.22	-3.61
90	+4.22	-6.02
91	+4.22	-8.43
92	+4.22	-10.85
93	+4.22	-13.26
94	+6.32	+12.60
95	+6.32	+9.65
96	+6.32	+7.24
97	+6.32	+4.83
98	+6.32	+2.41
99	+6.32	0.00
100	+6.32	-2.41
101	+6.32	-4.83
102	+6.32	-7.24
103	+6.32	-9.65

Ctc	X	Y
104	+6.32	-12.07
105	+8.43	+11.28
106	+8.43	+8.43
107	+8.43	+6.02
108	+8.43	+3.61
109	+8.43	+1.19
110	+8.43	-1.19
111	+8.43	-3.61
112	+8.43	-6.02
113	+8.43	-8.43
114	+8.43	-10.85
115	+10.77	+9.07
116	+10.54	+4.83
117	+10.54	+2.41
118	+10.54	0.00
119	+10.54	-2.41
120	+10.54	-4.83
121	+10.77	-9.07
122	+12.17	+7.09
123	+13.21	+4.83
124	+13.87	+2.41
125	+14.10	0.00
126	+13.87	-2.41
127	+13.21	-4.83
128	+12.17	-7.09

43

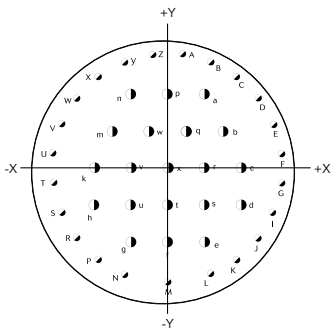

Ctc	X	Y
A	+1.75	+13.49
B	+5.16	+12.57
C	+8.23	+10.80
D	+10.77	+8.28
E	+12.52	+5.21
F	+13.49	+1.75
G	+13.49	-1.75
H	+12.52	-5.21
J	+10.77	-8.28
K	+8.23	-10.80
L	+5.16	-12.57
M	0.00	-13.49
N	-5.16	-12.57
P	-8.23	-10.80
R	-10.77	-8.28
S	-12.52	-5.21
T	-13.49	-1.75
U	-13.49	+1.75
V	-12.52	+5.21
W	-10.77	+8.28
X	-8.23	+10.80
Y	-5.16	+12.57

Ctc	X	Y
Z	-1.75	+13.4
a	+4.37	+8.74
b	+6.55	+4.37
c	+8.74	0.00
d	+8.74	-4.37
e	+4.37	-8.74
f	0.00	-8.74
g	-4.37	-8.74
h	-8.74	-4.37
k	-8.74	0.00
m	-6.55	+4.37
n	-4.37	+8.74
p	0.00	+8.74
q	+2.18	+4.37
r	+4.37	0.00
s	+4.37	-4.37
t	0.00	-4.37
u	-4.37	-4.37
v	-4.37	0.00
w	-2.18	+4.37
x	0.00	0.00

61

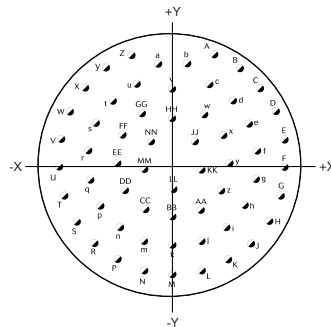

Ctc	X	Y
A	+4.98	+12.70
B	+7.98	+11.05
C	+10.49	+8.71
D	+12.32	+5.84
E	+13.39	+2.57
F	+13.61	-0.76
G	+12.98	-4.17
H	+11.53	-7.29
J	+9.35	-9.93

Ctc	X	Y
K	+6.58	-11.94
L	+3.40	-13.18
M	0.00	-13.64
N	-3.40	-13.18
P	-6.58	-11.94
R	-9.35	-9.93
S	-11.53	-7.29
T	-12.98	-4.17
U	-13.61	-0.76

Ctc	X	Y
V	-13.39	+2.57
W	-12.32	+5.84
X	-10.49	+8.71
Y	-7.98	-11.05
Z	-4.98	+12.10
a	-1.73	+11.53
b	+1.73	+11.53
c	+4.39	+9.22
d	+7.24	+7.19
e	+9.19	+4.45
f	+10.13	+1.17
g	+9.96	-2.24
h	+8.66	-5.41
i	+6.38	-7.98
j	+3.38	-9.63
k	0.00	-10.21
m	-3.38	-9.63
n	-6.38	-7.98
p	-8.66	-5.41
q	-9.96	-2.24
r	-10.13	+1.17
s	-9.19	+4.45

Ctc	X	Y
t	-7.24	+7.19
u	-4.39	+9.22
v	0.00	+8.59
w	+3.73	+5.66
x	+6.02	+3.10
y	+6.78	-0.25
z	+5.79	-3.53
AA	+3.33	-5.92
BB	0.00	-6.78
CC	-3.33	-5.92
DD	-5.79	-3.53
EE	-6.78	-0.25
FF	-6.02	+3.10
GG	-3.73	+5.66
HH	0.00	+5.08
JJ	+2.67	+2.39
KK	+3.43	-1.04
LL	0.00	-3.35
MM	-3.43	-1.04
NN	-2.67	+2.39
PP	0.00	0.00

# 8D SERIES

## 8D Series

# Derived Series

■ Reinforced sealing .....	86
■ Hermetic Series .....	89
■ Receptacle with clinch nuts or helicoils .....	96
■ Double flange .....	99
■ PCB contacts without shoulder .....	102
■ Plug with integrated backshell .....	104
■ Quadrax contacts .....	108
■ Power contacts .....	114
■ High power contacts .....	119
■ BMA coaxial contacts .....	124
■ Optical ELIO® contacts .....	128
■ RJ45/USB Series .....	134



## Description

- Reinforced sealed receptacle with male or female straight PC tail contacts
- Strong sealing performance:  $10^{-7}$  atm.cm<sup>3</sup>/s
- Designed for unpressurized area
- 125°C max (operational temperature)
- 100 % scoop proof
- Full RoHS solution
- High density connectors
- Weight saving compared to hermetic version
- Other **SOURIAU** ranges on request

## Technical features

### Mechanical

- **Shell plating:**
  - . 8D aluminum shell:
    - . Black zinc nickel (Z)
    - . Olive drab cadmium (W)
    - . Nickel (F)
  - . 8D composite shell:
    - . Olive drab cadmium (J)
    - . Nickel (M)
  - . 8D stainless steel shell:
    - . Nickel (S)
    - . Passivated (K)
  - . 8D titanium shell:
    - . Nickel (TF)
    - . Without plating (TT)
- **Insulator:** Thermoplastic
- **Interfacial seal:** Silicone elastomer
- **Contacts:** Copper alloy
- **Contacts plating:** Gold over nickel plated
- **Endurance:**
  - . 500 mating/unmating operations

### Electrical

- **Contact resistance:**

Contacts size	22	20	16
Resistance mΩ	14.6	7.3	3.8
- **Shielding:**
  - . F; S; TF: 65db - 10GHz
  - . F; Z; W; J; M: 85db - 1GHz
  - . Z; W: 50db - 10GHz
  - . K; TT: 45db - 10GHz
- **Shell continuity:**
  - . F; TF; S: 1mΩ
  - . Z; ZC; W: 2.5mΩ
  - . J; M: 3mΩ
  - . JVS: 5mΩ
  - . TT; K: 10mΩ

### Environmental

- **Temperature range:** -55°C +125°C
- **Sealing (initial):**  $10^{-7}$  atm.cm<sup>3</sup>/s
- **Salt spray:**
  - . F; S; TF: 48h
  - . Z; W; JVS; TT; K; S: 500h
  - . J; M: 2000h

## Ordering information

### 8D part number

<b>Basic Series:</b>	<b>8DR</b>	<b>0</b>	<b>C</b>	<b>09</b>	<b>Z</b>	<b>35</b>	<b>P</b>	<b>N</b>
<b>Shell type:</b>								
0: Square flange receptacle								
1: In line receptacle (8D aluminum only)								
7: Jam nut receptacle (except 8D Composite)								
<b>Contact type:</b>								
C: Receptacle with short PC tail (male and female #22D, #20, #16, #12)								
L: Connector with long PC tail (male and female #22D)								
S: Connector with specific PC Tail (male and female #22D)								
M: Connector with medium PC tail (male #22D)								
P: Connector with solder cup: . Pin: #22D, #20 & #16; Socket: #12								
. Socket: #22D, #20 & #16; Pin: #12 - Please consult us								
<b>Shell size</b>								
09, 11, 13, 15, 17, 19, 21, 23, 25								
<b>Aluminum plating:</b>								
F: Nickel								
Z: Black zinc nickel								
W: Olive drab cadmium								
<b>Composite plating:</b>								
J: Olive drab cadmium								
M: Nickel								
<b>Stainless steel plating:</b>								
K: Passivated								
S: Nickel								
<b>Titanium plating:</b>								
TT: Without plating								
TF: Nickel								
<b>Contact layout</b>								
See next page								
<b>Contact type:</b>								
P: Male								
S: Female								
<b>Orientation</b>								
N, A, B, C, D, E								

Double flange receptacle available, please consult us.

Receptacle with integrated clinch nuts or helicoils available, please consult us.

Contacts without shoulder available, please consult us.

## Contact layouts

For C or L contact type. For other contact type or layouts, please consult us.

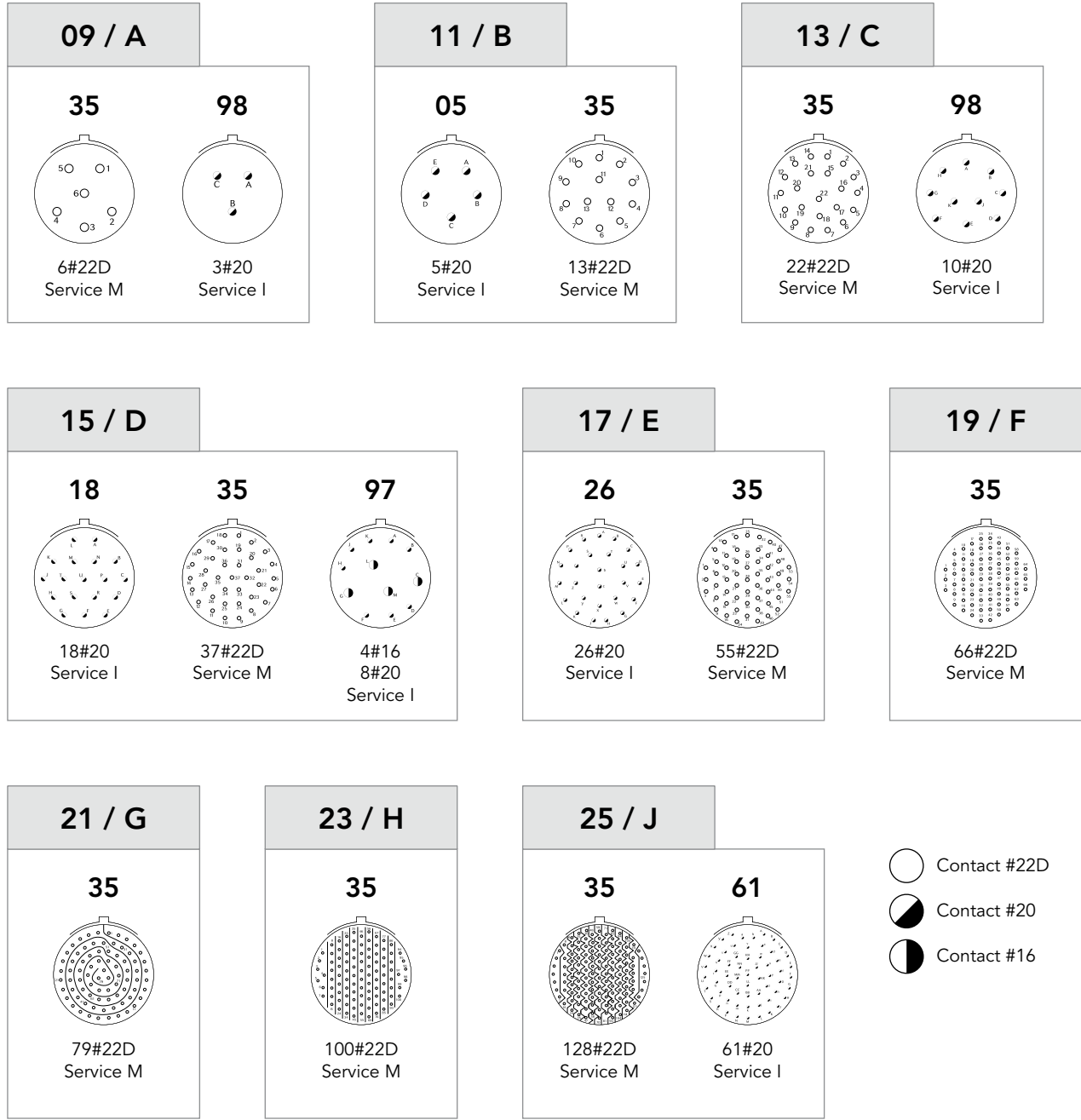





## Description

- Glass sealed hermetic:
  - . high hermeticity performance
  - . compact low profile
- Quick screw coupling according to EN3645 and MIL-DTL-38999 Series III standards
- Robust stainless steel adapted for any weld or solder operation
- Various mounting styles:
  - . compact solder mount receptacle
  - . easy to install square flange receptacle
  - . easy to replace jam nut receptacle
- Signal and power contacts
- Various PCB contact versions available
- Special fuel tank versions for long term fuel immersion
- 230V qualified versions where higher voltage is used to reduce cable weight

## Technical features

### Mechanical

- **Shell:**
  - . Class Y: passivated stainless steel
  - . Class N: nickel plated stainless steel
- **Seals:**
  - . Silicone elastomer
- **Contact:**
  - . Gold plated ferrous alloy
- **Endurance:**
  - . 500 mating/unmating operations

### Electrical

- **Max current rating per contact:**

Contact size	22D	20	16	12	8	4
Rating (A)	3	5	10	17	33	60

- **Dielectric withstanding voltage:**

Service	Sea level	30 000 m
M	1 300 Vrms	800 Vrms
I	1 800 Vrms	1 000 Vrms
II	2 300 Vrms	1 000 Vrms

- **Shielding:**
  - . Class Y: 45 dB min at 10 GHz
  - . Class N: 65 dB min at 10 GHz
- **Insulation resistance:**
  - . 5000 MΩ (under 500 Vdc)

### Environmental

- **Operating temperature:** -65°C to 200°C
- **Hermeticity:** leak rate <math>10^{-7}</math> atm.cm<sup>3</sup>/s (helium gas test)
- **Salt spray:**
  - . Class Y: 500 hours
  - . Class N: 48 hours
- **Resistance to fluids per MIL-DTL-38999:**
  - . Gasoline JP5 (OTAN 44) - short immersion
  - . Mineral hydraulic fluid MIL-H-5606 (OTAN H515)
  - . Synthetic hydraulic fluid Skydrol 500 B4
- **Fuel immersion version:**
  - . JP5 - long term immersion
  - . 105°C max

### Contact layouts (matrix)

Shell size	Layout	8D type 21 Spec. 600*	8D Spec. 022*	8D Spec. 840 & 850	Number of contacts				
					#22D	#20	#16	#12	#8
09	09-35		OK	OK	6				
	09-98		OK	OK		3			
11	11-35		OK	OK	13				
	11-98			OK		6			
13	13-04	OK					4		
	13-08			OK		8			
	13-35		OK	OK	22				
	13-98			OK		10			
15	15-18			OK		18			
	15-19		OK	OK		19			
	15-35		OK	OK	37				
	15-97					8	4		
17	17-06	OK	OK					6	
	17-08	OK					8		
	17-26			OK		26			
	17-35		OK	OK	55				
19	19-35			OK	66				
21	21-41			OK		41			
	21-48	OK	OK						4
23	23-53			OK		53			
	23-55			OK		55			
25	25-04					48	8		
	25-19							19	

OK SOURIAU's layout

\* Spec. 600 = 230V qualified connector; Spec. 022 = Fuel tank version; Spec. 840 & 850 = PC tail lengths, see page 95.

### Orientations

Viewed from front face of receptacle

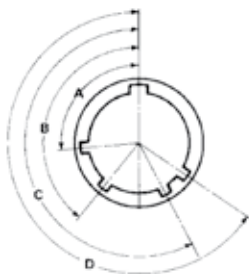

Viewed from front face of plug

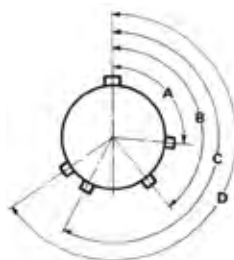

Shell size	Angles	N	A	B	C	D	E	T	V
9 (A)	A°	105	102	80	35	64	91	-	-
	B°	140	132	118	140	155	131	-	-
	C°	215	248	230	205	234	197	-	-
	D°	265	320	312	275	304	240	-	-
11 (B) 15 (D)	A°	95	113	90	53	119	51	-	-
	B°	141	156	145	156	146	141	-	-
	C°	208	182	195	220	176	184	-	-
	D°	236	292	252	255	298	242	-	-
13 (C)	A°	95	113	90	53	119	51	70	75
	B°	141	156	145	156	146	141	136	138
	C°	208	182	195	220	176	184	218	224
	D°	236	292	252	255	298	242	261	268
17 (E) 21 (G)	A°	80	135	49	66	62	79	58	85
	B°	142	170	169	140	145	153	162	150
	C°	196	200	200	200	180	197	188	191
	D°	293	310	244	257	280	272	316	307
19 (F) 23 (H) 25 (J)	A°	80	135	49	66	62	79	-	-
	B°	142	170	169	140	145	153	-	-
	C°	196	200	200	200	180	197	-	-
	D°	293	310	244	257	280	272	-	-

## Connector part numbers

### Standard configuration

<b>Basic Series</b>	F38999	21	Y	A	35	P	N	WF
<b>Shell style:</b>								
21: Square flange receptacle								
23: Jam nut receptacle								
25: Solder mounting receptacle								
27: Weld mounting receptacle								
<b>Class:</b>								
Y: Passivated stainless steel								
N: Nickel plated stainless steel								
<b>Shell size:</b>								
09=A, 11=B, 13=C, 15=D, 17=E, 19=F, 21=G, 23=H, 25=J								
<b>Contact layout:</b>								
See previous page and pages 13 to 17								
<b>Contact type:</b>								
P: Male solder cup								
C: Male PCB contacts								
<b>Orientation:</b>								
N, A, B, C, D, E, T, V								
<b>Specification:</b>								
WF: Standard								
600: 230V qualified connector (layouts 13-04, 17-08, 21-11 & 21-48 - orientation T & V)								

### Specific configuration

<b>Basic Series</b>	8D	0	Y	13	35	P	N	022
<b>Shell style:</b>								
0: Square flange receptacle								
1: Solder mount receptacle								
7: Jam nut receptacle								
<b>Class:</b>								
Y: Passivated stainless steel								
N: Nickel plated stainless steel								
<b>Shell size:</b>								
09, 11, 13, 15, 17, 19, 21, 23, 25								
<b>Contact layout:</b>								
See previous page and pages 13 to 17								
<b>Contact type:</b>								
P: Male solder cup								
C: Male PCB contacts								
<b>Orientation:</b>								
N, A, B, C, D, E								
<b>Specification:</b>								
022: Fuel tank								
840: Short PCB contact								
850: Long PCB contact								

## Dimensions

### Square flange receptacle (type 21)

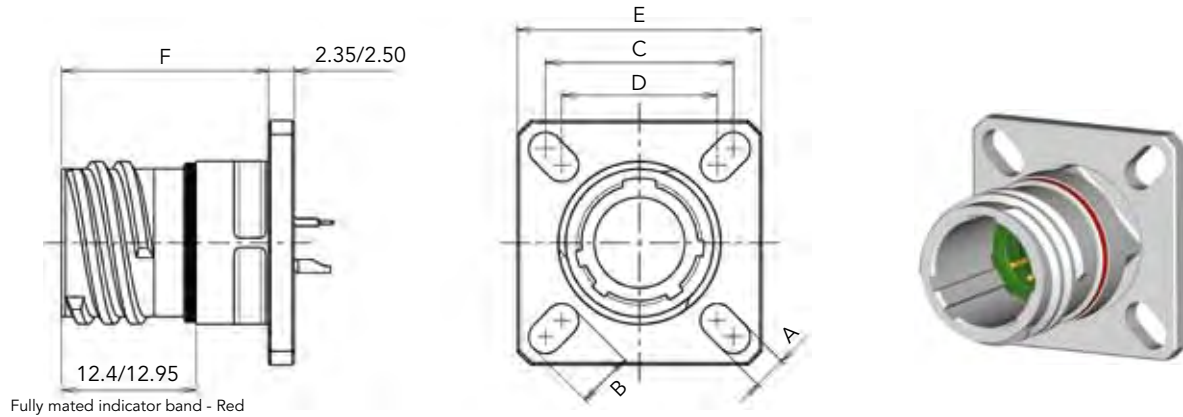

Shell size	A ± 0.20	B ± 0.20	C	D	E ± 0.30	F max	Ø G	Ø H	J max	K max
A (9)	3.25	5.49	18.26	15.09	23.80	20.40	13.11	16.66	2.5	3.2
B (11)		4.93	20.62	18.26	26.20		15.88	20.22		
C (13)			23.01	20.62	28.60		19.05	23.42		
D (15)		4.39	24.61	23.01	31.00		23.01	26.59		
E (17)			26.97	24.61	33.30		25.81	30.96		
F (19)		4.93	29.36	26.97	36.50		28.98	32.94		
G (21)		31.75	29.36	39.70	32.16	36.12				
H (23)	3.91	6.15	34.93	31.75	42.90	34.93	39.29			
J (25)			38.10	34.93	46.00	37.69	42.47			

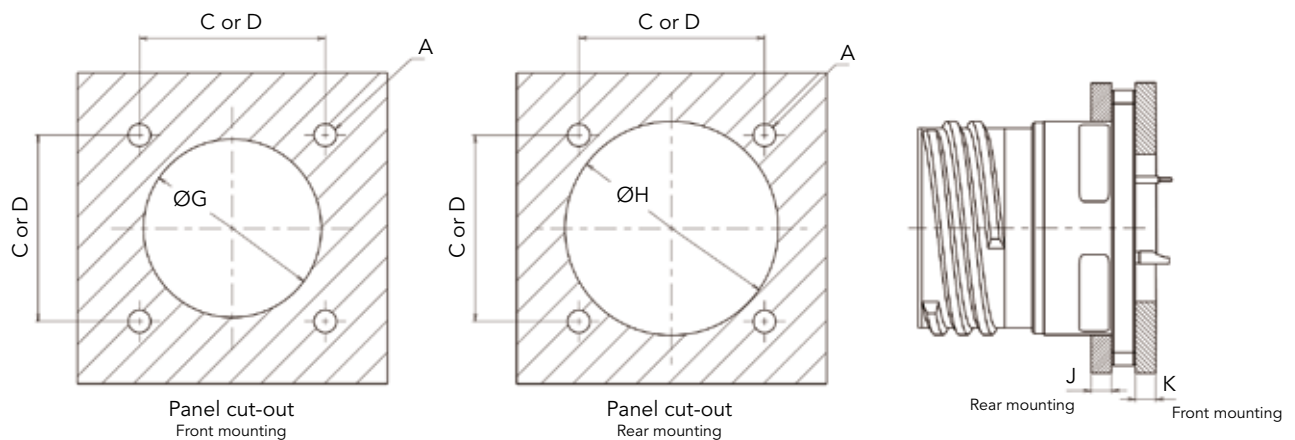

Note: All dimensions are in millimeters (mm)

Jam nut receptacle (type 23)

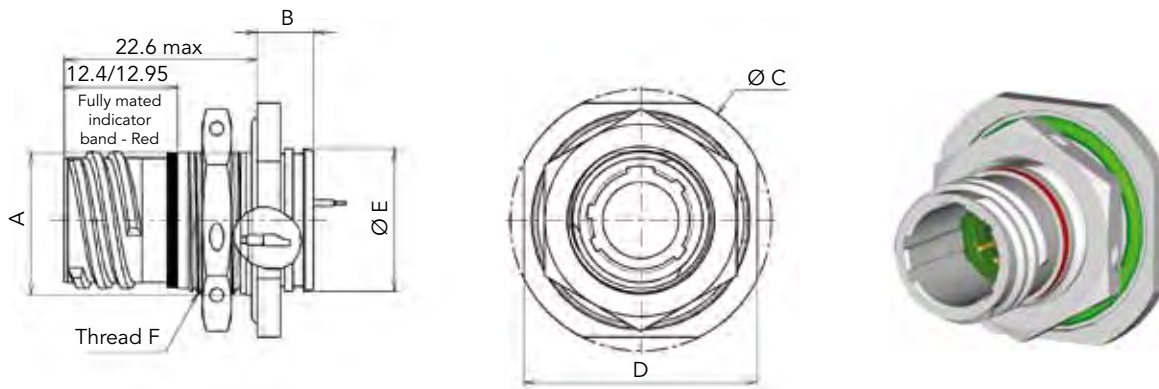

Shell size	A flat $\pm 0.18$	B max	$\text{Ø C} \pm 0.30$	$D \pm 0.40$	$\text{Ø E} \pm 0.30/0$	F thread	$\text{Ø G} \pm 0.25$	H	J
A (9)	16.53	9.10	30.20	27.00	16.30	M17 x 1-6g	17.78	17.02	3.2
B (11)	19.07		34.90	31.80	19.40	M20 x 1-6g	20.96	19.59	
C (13)	23.82		38.10	34.90	22.70	M25 x 1-6g	25.65	24.26	
D (15)	26.97		41.30	38.10	25.90	M28 x 1-6g	28.83	27.56	
E (17)	30.15		44.50	41.30	29.00	M32 x 1-6g	32.01	30.73	
F (19)	33.32	9.70	49.20	46.00	32.20	M35 x 1-6g	35.18	33.91	
G (21)	36.50		52.40	49.20	35.40	M38 x 1-6g	38.35	37.08	
H (23)	39.67		55.60	52.40	38.60	M41 x 1-6g	41.53	40.26	
J (25)	42.85		58.70	55.60	41.70	M44 x 1-6g	44.70	43.43	

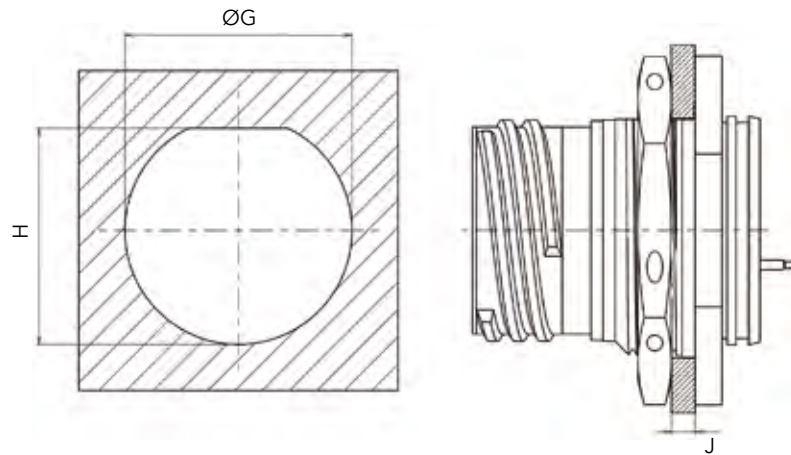

Note: All dimensions are in millimeters (mm)

### Solder mounting receptacle (type 25)

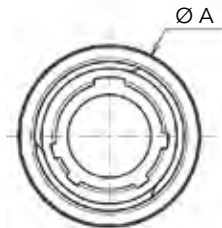
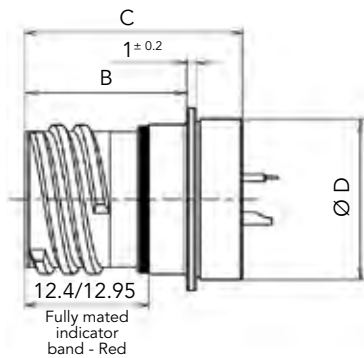

Shell size	Ø A max	B max	C max	D max
A (9)	19.40	17.20	23.80	17.10
B (11)	21.80			19.90
C (13)	24.90			23.10
D (15)	28.10			26.20
E (17)	31.30			29.40
F (19)	33.60			31.80
G (21)	36.80			35.00
H (23)	40.00	24.60		38.20
J (25)	43.20			41.30

### Weld mounting receptacle (type 27)

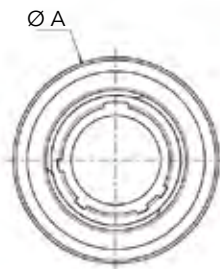
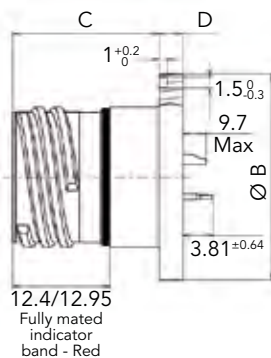

Shell size	Ø A <sup>+0.3</sup> <sub>-0</sub>	Ø B <sup>±0.3</sup>	C max	D <sup>±0.2</sup>
A (9)	24.70	23.90	23.20	3.20
B (11)	27.80	27.00		
C (13)	31.00	30.20		
D (15)	34.20	33.40		
E (17)	36.40	35.60		
F (19)	40.10	39.30		
G (21)	43.70	42.90		
H (23)	47.90	47.10	24.00	4.00
J (25)	50.10	49.30		

### Maximum connector weight (in grams)

Shell size	Square flange receptacle	Jam nut receptacle	Solder mount receptacle
09 (A)	23	39	21
11 (B)	28	53	25
13 (C)	35	63	31
15 (D)	41	73	38
17 (E)	57	92	53
19 (F)	60	106	55
21 (G)	65	118	57
23 (H)	75	132	68
25 (J)	91	154	83

### Gaskets

Shell size	Gasket for receptacle Type 0		O ring for receptacle Type 7	
	Part number	Material	Part number	Material
09 (A)	85995541	Fluoro silicone	AS3582-019	Silicone
11 (B)	85995542	Fluoro silicone	AS3582-022	Silicone
13 (C)	85995543	Fluoro silicone	AS3582-024	Silicone
15 (D)	85995544	Fluoro silicone	AS3582-026	Silicone
17 (E)	85995545	Fluoro silicone	AS3582-028	Silicone
19 (F)	85995546	Fluoro silicone	AS3582-128	Silicone
21 (G)	85995547	Fluoro silicone	AS3582-130	Silicone
23 (H)	85995548	Fluoro silicone	AS3582-132	Silicone
25 (J)	85995549	Fluoro silicone	AS3582-134	Silicone

Note: All dimensions are in millimeters (mm)

## Contact variations

### Contact variations summary

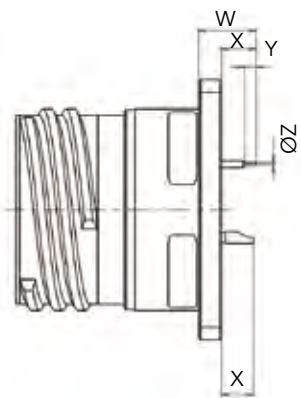

**Type 21:** Square flange receptacle

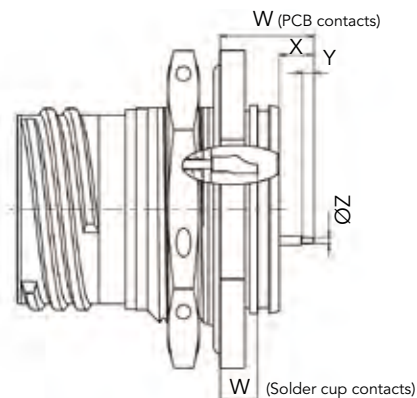

**Type 23:** Jam nut receptacle

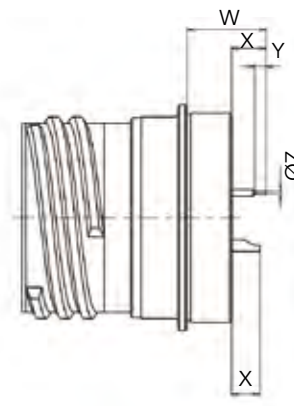

**Type 25:** Solder mount receptacle

Type of contact	Specification	Type of shell	Contact size	W max	X min	Y min	ØZ max
Solder cup ( P )	WF (F38999)	21	20 & 22	N/A	3.45	N/A	N/A
		23	20 & 22	4.5	N/A	N/A	N/A
		25	20 & 22	N/A	2.3	N/A	N/A
PCB ( C )	WF (F38999)	21	16	6.65	3.45	N/A	N/A
			20			0.89	0.71
			22			0.89	0.38
		23	16	11.5	3.3	N/A	N/A
			20			0.89	0.71
			22			0.89	0.38
		25	16	10.75	3.4	N/A	N/A
			20	12.15		0.89	0.71
			22	13.55		0.89	0.38
	840 (8D)	21	20	8.05	4.85	4.5	0.62
			22	7.32	4.12	3.82	0.53
		23	20	11.8	3.6	4.5	0.62
			22	10.6	2.4	5.75	0.53
		25	20	10.15	3.7	4.5	0.62
			22	9.42	2.97	3.82	0.53
850 (8D)	21	20	13	9.8	6	0.62	
		22	10.69	7.49	7.35	0.53	
	23	20	15.3	7.1	6.25	0.62	
		22	16.2	8	9.25	0.45	
	25	20	15.1	8.65	6	0.62	
		22	12.79	6.34	7.35	0.53	

Note: All dimensions are in millimeters (mm)



## Description

- Square flange receptacle with 4 clinch nuts or 4 helicoils
- Clinch nut & helicoils are self-locking
- Rear mounting
- Easy to install, time saving
- Equivalent MIL level qualification as 38999 Series III
- Clinch nut & helicoil tested:
  - . Impact test (drop 0.4kg from height of 100mm)
  - . Push out test (130N during 15s max)
  - . Wrench out test (1N/m)

## Technical features

### Mechanical

- **Shell:** Aluminum
- **Shells plating:**
  - Black zinc nickel (Z)
  - Cadmium olive drab (W)
  - Nickel (F)
- **Insulator:** Thermoplastic
- **Grommet and interfacial seal:** Silicone elastomer
- **Contact:** Copper alloy
- **Contact plating:** Gold over nickel plated
- **Endurance:**
  - . 500 mating/unmating operations
- **Shock:**
  - 300g, 3ms according EN2591-D2 method A
- **Vibration:**
  - . Sinus:
    - . 10 à 2000 Hz, 3x12 hrs (60g, 140 - 2000 Hz) with T° cycling
  - . Random:
    - . 50 to 2000 Hz, 2x8 Hrs (1g/√ Hz, 100 - 2000Hz) at T° max.
    - . 25 to 2000 Hz, 2x8 Hrs (5g/√ Hz, 100 - 300Hz) at ambient T°
- **Contact retention:**

Contacts size	26	22	20	16	12	8	4
Min force in N	30	44	67	111	111	111	200

### Electrical

- **Test voltage rating (Vrms)**

Service	sea level	at 21000 m
R	400	N/A
M	1 300	800
N	1 000	600
I	1 800	1 000
II	2 300	1 000

- **Contact resistance**

Contacts size	26	22	20	16	12	8	4
Resistance mΩ	16	14.6	7.3	3.8	3.5	3	2

- **Insulation resistance:**
  - ≥ 5 000 MΩ (under 500 Vdc)

- **Contact rating:**

Contacts size	26	22	20	16	12	8	4
Rating (A)	3	5	7.5	13	23	45	80

- **Shell continuity**
  - Black zinc nickel (Z): 2.5 mΩ
  - Cadmium olive drab (W): 2.5 mΩ
  - Nickel (F): 1 mΩ

- **Shielding:**
  - F: 65 db at 10 GHz
  - Z, F & W: 85 db at 1 GHz
  - Z & W: 50 db at 10 GHz

### Environmental

- **Temperature range:**
  - W: -65°C +175°C
  - Z & F: -65°C +200°C
- **Sealing:**
  - Mated connectors meet altitude immersion requirements of MIL-DTL-38999.
- **Salt spray:**
  - Z & W: 500 Hours
  - F: 48 Hours

### Resistance to fluids

- **According to MIL-DTL-38999 standard**
  - . Gasoline: JP5 (OTAN F44)
  - . Mineral hydrolic fluid: MIL-H-5606 (OTAN H515)
  - . Synthetic hydraulic fluid: Skydrol 500 B4
- **LD4 (SAE AS 1241)**
  - . Mineral lubricating: MIL-L-7870A (OTAN 0142)
  - . Synthetic lubricating: MIL-L-23699 (OTAN 0156), MIL-L-7808
  - . Cleaning fluid: MIL-C-87936 diluted
  - . De-icing fluid: MIL-A-8243
  - . Extinguishing fluid: Bromochloromethane
  - . Cooling fluid: Coolanol



## Ordering information

Basic Series	8D	34	-	19	F	35	S	N
<b>Shell style:</b> 34: Square flange receptacle with M3 clinch nuts, F & W only 35: Square flange receptacle with M3 helicoils, Z only 37: Square flange receptacle with UNC 4-40 helicoils, Z only 39: Square flange receptacle with UNC 4-40 clinch nuts, F & W only								
<b>Contact length:</b> (consult us) - : Connectors with standard crimp contacts C: Short PC tail L: Long PC tail								
<b>Shell size:</b> 9 - 11 - 13 - 15 - 17 - 19 - 21 - 23 - 25								
<b>Plating:</b> Z: Black zinc nickel F: Nickel W: Olive green cadmium								
<b>Contact layout:</b> See pages 13 to 17								
<b>Contact type:</b> P: Pin S: Socket								
<b>Orientation:</b> N, A, B, C, D & E								
<b>Specification:</b> 046: Tin plated contact SnPb 046E: Tin plated contact Sn pure 046S: Tin plated contact SAC305 900: Contact without shoulder (gold plated) 901: Tin plated contact without shoulder SnPb 901E: Tin plated contact without shoulder Sn pure 901S: Tin plated contact without shoulder SAC305								

## Dimensions

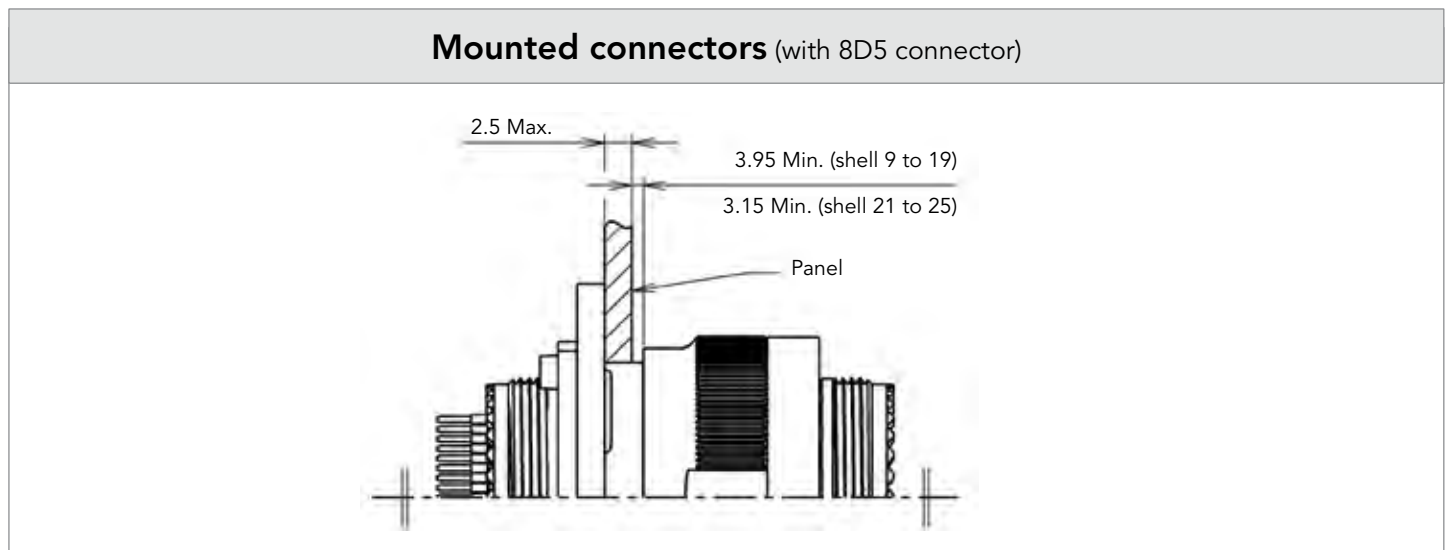

Note: All dimensions are in millimeters (mm)

### Square flange receptacle - type 34 & type 39

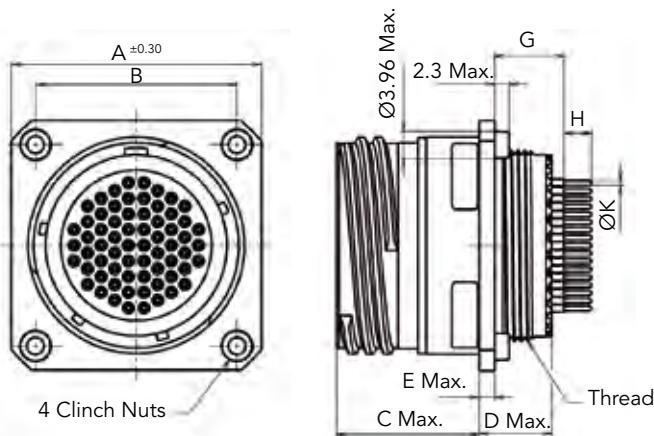

Shell Size	A ±0.3	B	C Max	D Max	E Max	Thread
9	27.79	18.26	20.90	10.60	2.50	M12x1-6g
11	30.15	20.62				M15x1-6g
13	32.54	23.01				M18x1-6g
15	34.14	24.61				M22x1-6g
17	36.5	26.97				M25x1-6g
19	38.89	29.36	20.10	11.40	3.20	M28x1-6g
21	41.27	31.75				M31x1-6g
23	44.45	34.93				M34x1-6g
25	47.62	38.1				M37x1-6g

#### Short contact length

Min / Max - For other length please consult us

Shell size	G					H		K	
	#22D		#20		#16	#22D	#20 & #16	#22D & #20	#16
	P	S	P	S	P & S	P & S	P & S	P & S	P & S
9 to 19	9.47 / 10.54	9.09 / 10.54	9.64 / 10.71	9.26 / 10.71	9.64 / 10.75	3.8 / 4.0	4.9 / 5.1	0.65 / 0.70	1.09 / 1.15
21 to 25	9.58 / 10.65	9.20 / 10.65	9.75 / 10.82	9.37 / 10.82	9.75 / 10.86				

### Square flange receptacle - type 35 & type 37

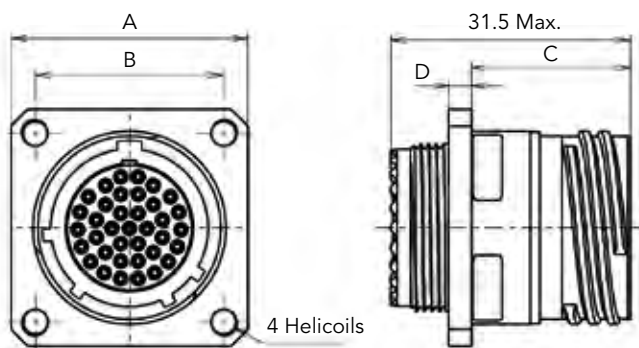

Shell Size	A	B	C	D
9	23.8	18.26	20.83	3
11	26.2	20.62		
13	28.6	23.01		
15	31	24.61		
17	33.3	26.97		
19	36.5	29.36	20.07	
21	39.7	31.75		
23	42.9	34.93		
25	46	38.1		

#### Short contact length

See table above.

Note: All dimensions are in millimeters (mm)

## Description

- High level vibration resistance in harsh environments
- Offers the same level of performance as the MIL-DTL-38999 Series III connector
- Jam nut or square flange receptacle
- No risk of breaking contacts
- No risk of micro-cuts
- Allow direct grounding from PCB to the flange
- PC tails contacts without shoulder: #16, #20 and #22
- Resin sealed version, please consult us

## Technical features

### Mechanical

- **Shell:** Aluminum
- **Shell plating:**
  - . Cadmium olive drab (W)
  - . Nickel (F)
  - . Black zinc nickel (Z)
- **Insulator:** Thermoplastic
- **Grommet and interfacial seal:** Silicone elastomer
- **Contacts:** Copper alloy
- **Contacts plating:** Gold over nickel plated
- **Endurance:** 500 mating cycles
- **Shock:** 300g, 3ms according EN2591-D2 method A
- **Vibration:**
  - . Sinus:
    - . 10 à 2000 Hz, 3x12 hrs (60g, 140 - 2000 Hz) with T° cycling
  - . Random:
    - . 50 to 2000 Hz, 2x8 Hrs (1g2/ Hz, 100 - 2000Hz) at T° max.
    - . 25 to 2000 Hz, 2x8 Hrs (5g2/ Hz, 100 - 300Hz) at ambient T°
- **Contact retention:**

Contacts size	22	20	16
Min force in N	44	67	111

### Electrical

- **Test voltage rating (Vrms)**

Service	sea level	at 21000 m
M	1 300	800
N	1 000	600
I	1 800	1 000
II	2 300	1 000

- **Contact resistance**

Contacts size	22	20	16
Resistance mΩ	14.6	7.3	3.8

- **Insulation resistance:** ≥ 5 000 MΩ (under 500 Vdc)

- **Contact rating:**

Contacts size	22	20	16
Rating (A)	5	7.5	13

- **Shell continuity:**
  - . Cadmium olive drab (W): 2.5 Ωh
  - . Nickel (F): 1 Ωh
  - . Black zinc nickel (Z): 2.5 Ωh

- **Shielding:**
  - . F: 65 db at 10 GHz; 85 db at 1 GHz
  - . W: 50 db at 10 GHz
  - . Z: Consult us

### Environmental

- **Temperature range:**
  - . W: -65°C +175°C
  - . F: -65°C +200°C
  - . Z: -65°C +200°C
- **Sealing:** Mated connectors meet altitude immersion requirements of MIL-DTL-38999.
- **Salt spray:**
  - . W: 500 Hrs
  - . F: 48 Hrs
  - . Z: 500 Hrs

### Resistance to fluids

- **According to MIL-DTL-38999 standard**
  - . Gasoline: JP5 (OTAN F44)
  - . Mineral hydrolic fluid: MIL-H-5606 (OTAN H515)
  - . Synthetic hydraulic fluid: Skydrol 500 B4
- **LD4 (SAE AS 1241)**
  - . Mineral lubricating: MIL-L-7870A (OTAN 0142)
  - . Synthetic lubricating: MIL-L-23699 (OTAN 0156), MIL-L-7808
  - . Cleaning fluid: MIL-C-87936 diluted
  - . De-icing fluid: MIL-A-8243
  - . Extinguishing fluid: Bromochloromethane
  - . Cooling fluid: Coolanol

## Ordering information

<b>Basic Series</b>	<b>8D</b>	<b>87</b>	<b>11</b>	<b>C</b>	<b>17</b>	<b>W</b>	<b>35</b>	<b>P</b>	<b>N</b>	<b>L</b>
<b>Shell type:</b>										
80: Square flange receptacle										
87: Jam nut receptacle										
<b>Length between panel &amp; PCB (in mm)</b>	For other length, please consult us.									
<b>Type:</b>										
C: Receptacle with short PC tail										
L: Receptacle with long PC tail										
<b>Shell size: 09, 11, 13, 15, 17, 19, 21, 23, 25</b>										
<b>Plating:</b>										
W: Olive green cadmium										
F: Nickel (RoHS)										
Z: Zinc nickel (RoHS)										
<b>Contact layout:</b>	Consult us for available layouts									
<b>Contact type:</b>										
P: Pin										
S: Socket										
<b>Orientation: N, A, B, C, D, E</b>										
<b>Specification:</b>										
None: Standard				046: Tin plated contact SnPb						
L: Without contacts				046E: Tin plated contact Sn pure (RoHS)						
For other specification, please contact us				046S: Tin plated contact SAC305 (RoHS)						

## Dimensions

### Jam nut receptacle (type 87)

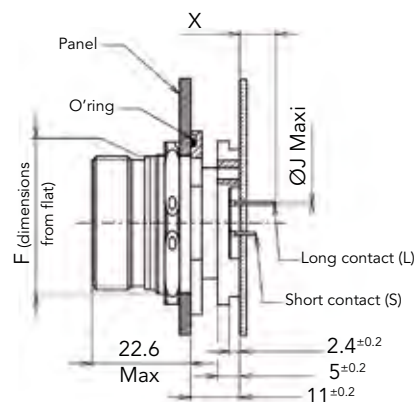
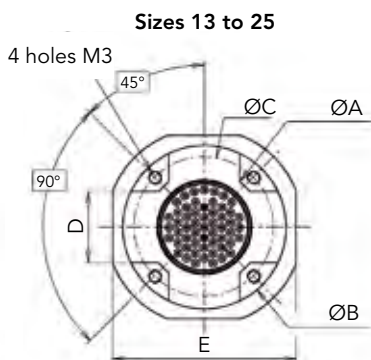
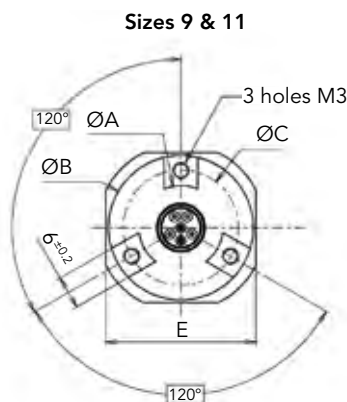

Shell size	ØA ± 0.15	ØB ± 0.15	ØC	D <sup>+0</sup> / <sub>-0.2</sub>	E ± 0.4	F ± 0.15
9	15.10	26.00	20.50	-	27.00	16.53
11	19.90	30.80	25.20	-	31.80	19.07
13	19.90	30.80	25.25	12	34.90	23.82
15	23.00	33.90	28.42	14	38.10	26.97
17	26.00	36.80	31.42	16	41.30	30.15
19	29.50	40.40	35.03	18	46.00	33.32
21	32.50	43.20	37.82	20	49.20	36.50
23	35.50	46.50	41.12	23	52.40	39.67
25	38.60	49.60	44.30	25	55.60	42.85

Contact size	Contact type	PC tail length	Size 09 & 11	Size 13 to 25	ØJ max
			X Min	X Min	
22D	M & F	Long	7.1	7.1	0.7
	M & F	Short	3.6	3.6	
20	M & F	Long	7.1	7.1	0.9
	M & F	Short	3.6	4.2	
16	M & F	Long	7.1	7.1	1.35
	M & F	Short	3.6	4.2	

Note: All dimensions are in millimeters (mm)

### Square flange receptacle (type 80)

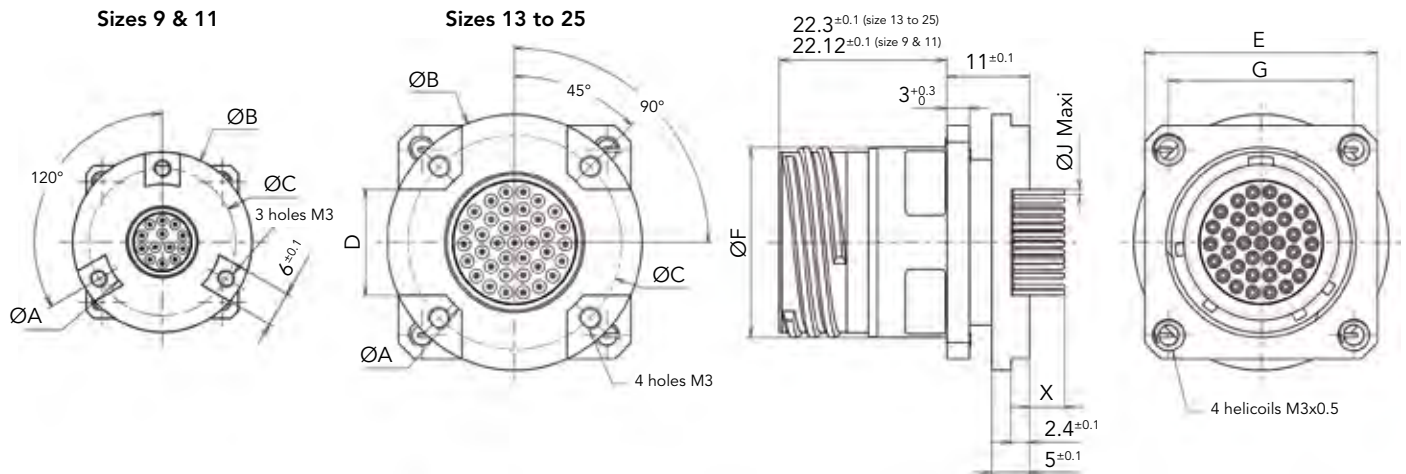

Shell size	$\varnothing A \pm 0.1$	$\varnothing B \pm 0.1$	$\varnothing C \pm 0.1$	$D \pm 0.1$	$E \pm 0.2$	$\varnothing F \pm 0.1$	$G \pm 0.1$
9	15.1	26	20.5	-	23.75	15.67	18.26
11	19.9	30.8	25.2	-	26.14	18.67	20.62
13	19.9	30.8	25.25	12	28.55	22.07	23.01
15	23	33.9	28.42	14	30.94	25.25	24.61
17	26	36.8	31.42	16	33.25	30	26.97
19	29.5	40.4	35.03	18	36.45	31.57	29.36
21	32.5	43.2	37.82	20	39.65	34.75	31.75
23	35.5	46.5	41.12	23	42.85	37.92	34.93
25	38.6	49.6	44.3	25	45.95	41.1	38.1

Contact size	Contact type	PC tail length	Size 09 & 11	Size 13 to 25	$\varnothing J$ max
			X Min	X Min	
22D	M	Long	7.39	7.21	0.70
		Short	4.39	4.21	
	F	Long	7.12	6.94	
		Short	4.12	3.94	
20	M	Long	7.39	7.21	0.90
		Short	4.39	4.21	
	F	Long	7.40	7.22	
		Short	4.40	4.22	
16	M	Long	7.39	7.21	1.35
		Short	4.39	4.21	
	F	Long	7.34	7.16	
		Short	7.34	4.16	

Note: All dimensions are in millimeters (mm)

### Comparison

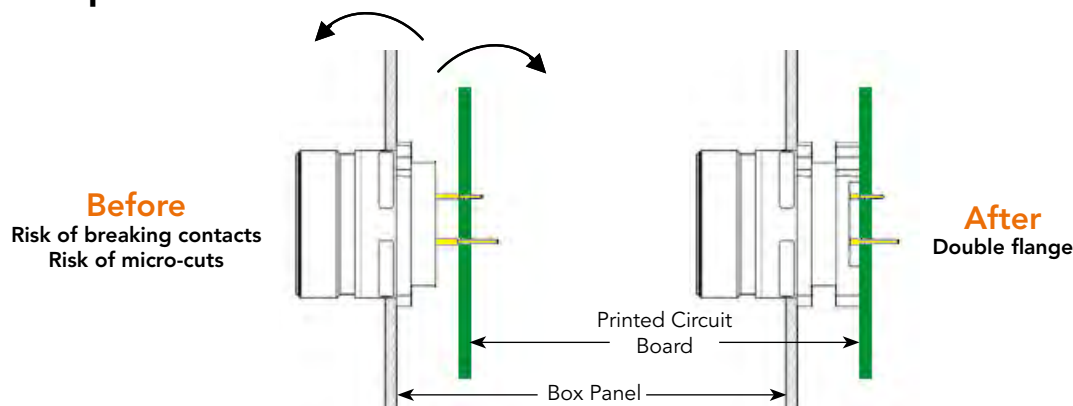



## Description

- Pin & socket PCB contacts without shoulder #20 & #22D as per MIL-DTL-38999 Series I, II & III. Contacts without shoulder allows a more flexible mounting on variable PCB thicknesses or depths.
- Ruggedized contacts:
  - . Material: copper alloy
  - . Finish: gold per MIL-G-45204 type I class 1 over nickel plate
  - . Sleeve: stainless steel
- Flexible mounting:
  - . Various PCB thicknesses
  - . Multiple PCB positioning

## Ordering information

### 8D Series connector with PCB contacts without shoulder

<b>Basic Series:</b>	<b>8D</b>	<b>0</b>	<b>C</b>	<b>11</b>	<b>F</b>	<b>35</b>	<b>P</b>	<b>N</b>	<b>900</b>
<b>Shell type</b>									
0: Square flange receptacle									
7: Jam nut receptacle									
34: Square flange receptacle with M3 clinch nut (F or W plating, aluminum shell only)									
35: Square flange receptacle with M3 helicoils (Z plating, aluminum shell only)									
37: Square flange receptacle with UNC 4-40 helicoils (Z plating, aluminum shell only)									
39: Square flange receptacle with UNC 4-40 clinch nut (F or W plating, aluminum shell only)									
<b>PCB contact without shoulder type</b> (see next page for information & dimensions)									
C: Short PC tail									
M: Medium PC tail									
L: Long PC tail									
<b>shell size: 09, 11, 13, 15, 17, 19, 21, 23, 25</b>									
<b>8D aluminum plating</b>					<b>8D composite plating</b>				
F: Nickel					J: Olive green cadmium				
Z: Black zinc nickel					M: Nickel				
W: Olive green cadmium					X: Without plating				
ZC: Green zinc cobalt					<b>8D titanium plating</b>				
<b>8D stainless steel plating</b>					TT: Without plating				
K: Passivated					TF: Nickel				
S: Nickel									
<b>Contact layout:</b> See pages 13 to 17									
<b>Contact type</b>									
P: Male									
S: Female									
<b>Orientation: N, A, B, C, D, E</b>									
<b>Specification</b>									
900: Contact without shoulder with gold plated barrel (termination area)									
901: Contact without shoulder with tin plated SnPb barrel (termination area)									
901E: Contact without shoulder with tin plated Sn pure barrel (termination area)									
901S: Contact without shoulder with tin plated SAC305 barrel (termination area)									
<b>Special custom</b>									
None: Standard plastic cap									
M: Antistatic plastic cap									

Note: For JVS (8D Bronze Series, please consult us)

## Dimensions

### Type 0 & type 7

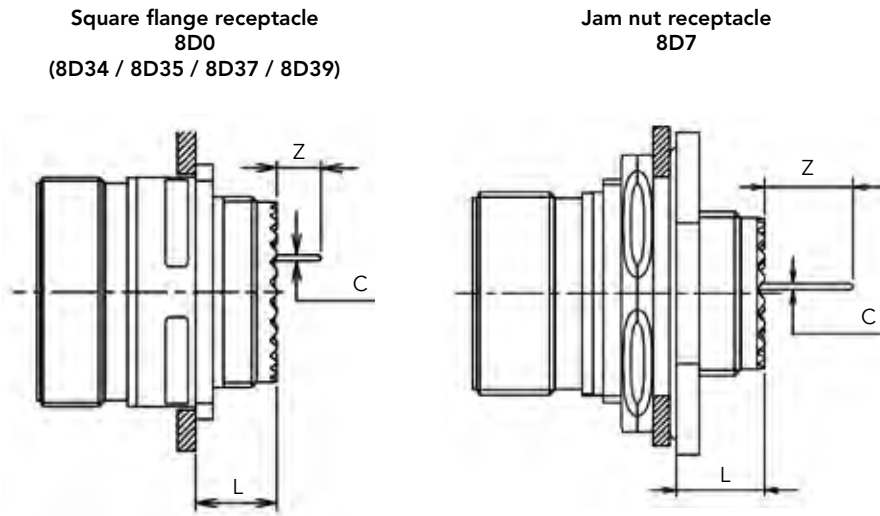

Contact size	Contact Type	Ø C Max	Square flange receptacle 8D0 / 8D34 / 8D35 / 8D37 / 8D39		Jam nut receptacle 8D7		
			Z Min	Z Max	Z Min	Z Max	
#22D & #20	Pin	C: Short PC tail	0.50	3.96	4.88	3.56	4.63
		M: Medium PC tail	0.50	5.99	6.91	5.59	6.66
		L: Long PC tail	0.50	7.51	8.43	7.11	8.18
#22D & #20	Socket	C: Short PC tail	0.50	3.96	5.21	3.56	4.81
		M: Medium PC tail	0.50	5.99	7.24	5.59	6.84
		L: Long PC tail	0.50	7.51	8.76	7.11	8.36

Shell type	Square flange receptacle 8D0 / 8D34 / 8D35 / 8D37 / 8D39		Jam nut receptacle 8D7
Shell size	9 to 19	21 to 25	9 to 25
L Max	10.7	11.5	9.90

Note: All dimensions are in millimeters (mm)



## Description

- Derived from standard MIL-DTL-38999 Series III
- Plug in 9 sizes (from size 09 to 25)
- Black zinc nickel, cadmium and nickel plating

## Technical features

### Mechanical

- **Shell:** Aluminum
- **Shell plating:**
  - . Nickel (F)
  - . Black zinc nickel (Z)
  - . Olive drab cadmium: (W)
- **Insulator:** Thermoplastic
- **Seal:** Silicone elastomer
- **Contact:** Copper alloy
- **Contact plating:** Gold over nickel
- **Endurance:** 500 matings/unmatings
- **Shock & Vibration:**
  - . According to 38999 specification

### Electrical

- **Contact resistance:**

Contacts size	22	20	16	12	8	4
Resistance mΩ	14.6	7.3	3.8	3.5	3	2

- **Insulation resistance:**
  - . ≥5000mΩ (at 500Vdc)

- **Contact rating:**

Contacts size	22	20	16	12	8	4
Rating (A)	5	7.5	13	23	45	80

- **Shell continuity**

- . Nickel (F): 1 mΩ
- . Black zinc nickel (Z): 2.5 mΩ
- . Olive drab cadmium (W): 2.5 mΩ

### Environmental

- **Temperature range:**
  - . -55°C to +175°C (Z & W)
  - . -55°C to +200°C (F)
- **Sealing mated connectors:**
  - . IP 67 (1 meter for 30 min minimum)
- **Salt spray:**
  - . 48 hours (F)
  - . 500 hours (Z & W)

### Resistance to fluids

- **According to MIL-DTL-38999 standard**
  - . Gasoline: JP5 (OTAN F44)
  - . Mineral hydraulic fluid: MIL-H-5606 (OTAN H515)
  - . Synthetic hydraulic fluid: Skydrol 500 B4
- **LD4 (SAE AS 1241)**
  - . Mineral lubricating: MIL-L-7870A (OTAN 0142)
  - . Synthetic lubricating: MIL-L-23699 (OTAN 0156), MIL-L-7808
  - . Cleaning fluid: MIL-C-87936 diluted
  - . De-icing fluid: MIL-A-8243
  - . Extinguishing fluid: Bromochloromethane
  - . Cooling fluid: Coolanol



## Ordering information

<b>Basic series</b>	8DA	5	-	13	Z	35	P	N
<b>Shell type:</b>	5: Plug with RFI shielding							
<b>Style:</b>	-: Connector with standard crimp contacts							
<b>Shell size:</b>	09; 11; 13; 15; 17; 19; 21; 23; 25							
<b>Plating:</b>	Z: Black zinc nickel F: Nickel W: Olive drab cadmium							
<b>Contact layout:</b>	See «8D Series - MIL-DTL-38999 Series III» SOURIAU catalog							
<b>Contact type:</b>	P: Male S: Female							
<b>Orientation:</b>	N, A, B, C, D, E							
<b>L:</b>	Without contact							

Note: Type 0 and Type 7 on request.

## Dimensions

### Plug Type 5

Technical drawings of Plug Type 5 showing side, front, and perspective views. Dimensions are indicated: 39.7 Max (total length), 12.1 Max (backshell length), and ØB Max (backshell diameter). The front view shows the contact array with a diameter of ØA Max.

	09	11	13	15	17	19	21	23	25
ØA	21.8	25	29.4	32.5	35.7	38.5	41.7	44.9	48
ØB	11.1	14.1	17.1	21.1	24.1	27.1	30.1	33.1	36.1

Note: All dimensions are in millimeters (mm)

## Accessories & Tooling

### Recommended accessories for wiring

Braid, straight heat shrink boot, elbow heat shrink boot, shield band, ...

Shell size	Shield band (recommended)	Hand banding tool	Rear diameter to fit with boot (mm)
9	85930337A (individually coiled) 85930338A (not individually coiled)	85930339A	11.1
11			14.1
13			17.1
15			21.1
17			24.1
19			27.1
21			30.1
23	85999344 (not individually coiled) 85999345 (individually coiled)	85999346	33.1
25			36.1



To order braid, boot (e.g. VG95343T type) or other accessories, please contact your SOURIAU distributor.

### Shield Band Dimension

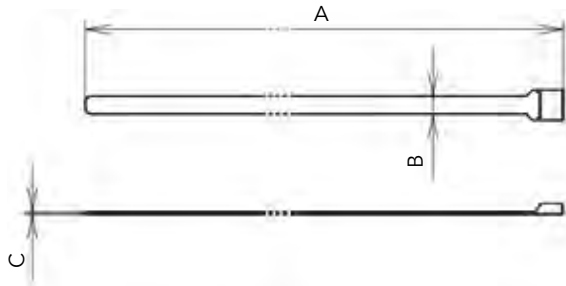

	85930337A or 85930338A	85999344 or 85999345
<b>A</b>	200 Min	362.1 <sup>±1.5</sup>
<b>B</b>	3	6
<b>C</b>	0.4 Max	0.5

Note: All dimensions are in millimeters (mm)

## Accessories & Tooling

### Recommended installation torque

Shell Size	Installation Torque (Inch-Pounds)
09, 11, 13, 15, 17 & 19	40
21, 23 & 25	80

Note: Torque values are based on 80% of the coupling thread strength specified in SAE-AS85049 standard.

### Tightening support

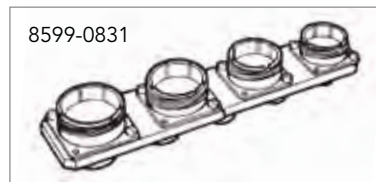

Part number: **8599-0831**  
 This tool is made up of dummy receptacles housings of all 9 sizes for all key polarisation, and secures free connectors during wiring and fitting of rear accessories.

### Crimping tools - for standard contacts

Contact size	Contact type	Contact Part number	Plier M22520/1-01		Plier M22520/2-01 (Souriau 8476-01)	
			Turret Part number		Locator Part number	
			MIL Spec	Souriau	MIL Spec	Souriau
#22D	Pin	8599-0702 JJ	-	-	M22520/2-09	8476-09
	Socket	8599-0706 900	-	-	M22520/2-07	8476-07
#20	Pin	8599-0703 SA	M22520/1-04	8365-04	M22520/2-10	8476-10
	Socket	8599-0707 900				
#16	Pin	8599-0704 MJ	M22520/1-04	8365-04	-	-
	Socket	8599-0708 900			-	-
#12	Pin	8599-0705 MJ	M22520/1-04	8365-04	-	-
	Socket	8599-0709 900			-	-

### Insertion & extraction tools - for standard contacts

Contact size	Material	Part number	Color	
			Insertion	Extraction
#22D	Plastic	M81969/14-01	Green	White
#20	Plastic	M81969/14-10	Red	Orange
#16	Plastic	M81969/14-03	Blue	White
#12	Plastic	M81969/14-04	Yellow	White
#10	Plastic	M81969/14-05	Grey	-

### Other Accessories, Tooling & Contacts

See "Common Section" page 63.



## Description

- Front and rear removable versions available
- Crimp and PC tail versions available
- Standard #8 cavity insertion and removal tools
- Ground connection of the cable braid to the shell possible through the external shell of the #8 contact
- Compatible with star quad cable
- Characteristic impedance of 100 Ohms
- Mixed layouts not grounded

## Technical features

### Mechanical

- **Operating temperature:**  
-65°C up to 150°C
- **Inner contact:**  
copper alloy
- **Contact body:**  
copper alloy
- **Contact insulator:**  
thermoplastic resin
- **Contact plating:**  
gold over nickel
- **Shell plating:**
  - . Aluminum shell:
    - Cadmium olive drab (W)
    - Nickel (F)
    - Black zinc nickel (Z)
    - Green zinc cobalt (ZC)
  - . Composite shell:
    - Cadmium olive drab (J)
    - Nickel (M)
    - Without plating (X)
  - . Stainless steel shell:
    - Passivated (K)
    - Nickel (S)
  - . Titanium shell:
    - Without plating (TT)
    - Nickel (TF)
  - . Bronze shell:
    - Without plating

### Electrical

- **ISO/IEC 11801 category 6 compliant:**
  - . Next (cross talk): > 46 db at 250 MHz
  - . Return loss: > 16 db at 250 MHz
  - . Shield effectiveness: > 36 db at 80 MHz
- **Contact to shell continuity:**  
< 10 mΩ
- **Contact resistance (low level):**
  - . Initial 15 mΩ
  - . After tests 30 mΩ
- **Dielectric withstanding voltage:**

Altitude	Service I
sea level	500 Vrms
21 000 m	125 Vrms
- **Insulation resistance:**
  - . At ambient temperature: > 5000 MΩ
  - . At high temperature: > 1000 MΩ
- **#24 contact cable size acceptance:**  
AWG 22 to AWG 26

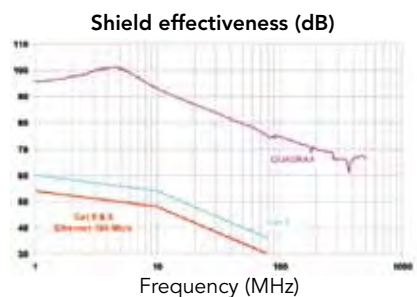
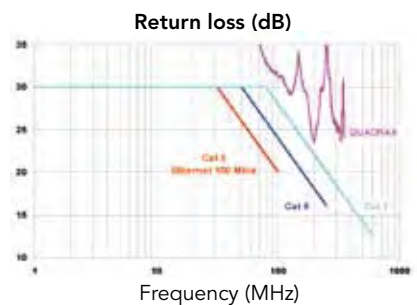
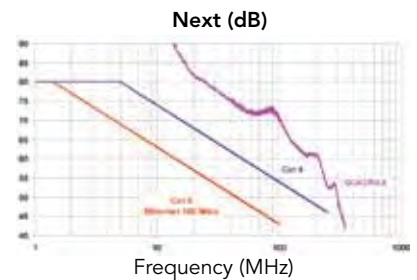

## Ordering information

### Aluminum, Composite, Stainless steel & Titanium connector

<b>Basic Series</b>	<b>8D</b>	<b>0</b>	<b>Q</b>	<b>11</b>	<b>W</b>	<b>81</b>	<b>P</b>	<b>N</b>	<b>284</b>	<b>L</b>
<b>Shell style:</b>										
0: Square flange receptacle										
5: Plug										
7: Jam nut receptacle										
<b>Type:</b>										
C: Quadrax PC tail contacts*										
Q: Quadrax crimp contacts										
<b>Shell size: 9 - 11 - 17 - 19 - 21 - 23 - 25</b> (see next page)										
<b>Plating:</b>										
<b>Aluminum shell:</b>					<b>Composite shell:</b>					
W: Olive green cadmium					J: Olive green cadmium					
F: Nickel					M: Nickel					
Z: Black zinc nickel					X: Without plating					
ZC: Green zinc cobalt					<b>Titanium shell:</b>					
<b>Stainless steel shell:</b>					TF: Nickel					
K: Passivated					TT: Without plating					
S: Nickel										
<b>Contact layout:</b> See next page										
<b>Contact type:</b>										
P: Pin										
S: Socket										
<b>Orientation: N, A, B, C, D &amp; E</b>										
<b>Specification:</b>										
284: Quadrax grounded PC tail contact (100Ω)*					550: Tin plated Quadrax not grounded PCB contact SnPb					
308: Quadrax not grounded PC tail contact (100Ω)					550S: Tin plated Quadrax not grounded PCB contact SAC305					
384: Quadrax grounded crimp contact (150Ω)*					550E: Tin plated Quadrax not grounded PCB contact Sn pur					
408: Quadrax not grounded crimp contact (150Ω)										
620: Quadrax grounded crimp contact (100Ω)*										
621: Quadrax not grounded crimp contact (100Ω)										
L: For P or S contact type only, connectors delivered without contacts, connectors marking P or S plus orientation										

### Bronze connector

<b>Basic Series</b>	<b>JVS</b>	<b>C</b>	<b>00A</b>	<b>09</b>	<b>35</b>	<b>P</b>	<b>N</b>	<b>284</b>	<b>L</b>
<b>Type:</b>									
C: Quadrax PC tail contacts*									
Q: Quadrax crimp contacts									
<b>Shell style:</b>									
00A: Square flange receptacle									
16A: Plug									
07A: Jam nut receptacle									
<b>Shell size: 9 - 11 - 17 - 19 - 21 - 23 - 25</b> (see next page)									
<b>Contact layout:</b> See next page									
<b>Contact type:</b>									
P: Pin									
S: Socket									
<b>Orientation: N, A, B, C, D &amp; E</b>									
<b>Specification:</b>									
284: Quadrax grounded PC tail contact (100Ω)*					550: Tin plated Quadrax not grounded PCB contact SnPb				
308: Quadrax not grounded PC tail contact (100Ω)					550S: Tin plated Quadrax not grounded PCB contact SAC305				
384: Quadrax grounded crimp contact (150Ω)*					550E: Tin plated Quadrax not grounded PCB contact Sn pur				
408: Quadrax not grounded crimp contact (150Ω)									
620: Quadrax grounded crimp contact (100Ω)*									
621: Quadrax not grounded crimp contact (100Ω)									
L: For P or S contact type only, connectors delivered without contacts, connectors marking P or S plus orientation									

\* For PC tail contacts or grounded versions please consult us.

## Contact layouts

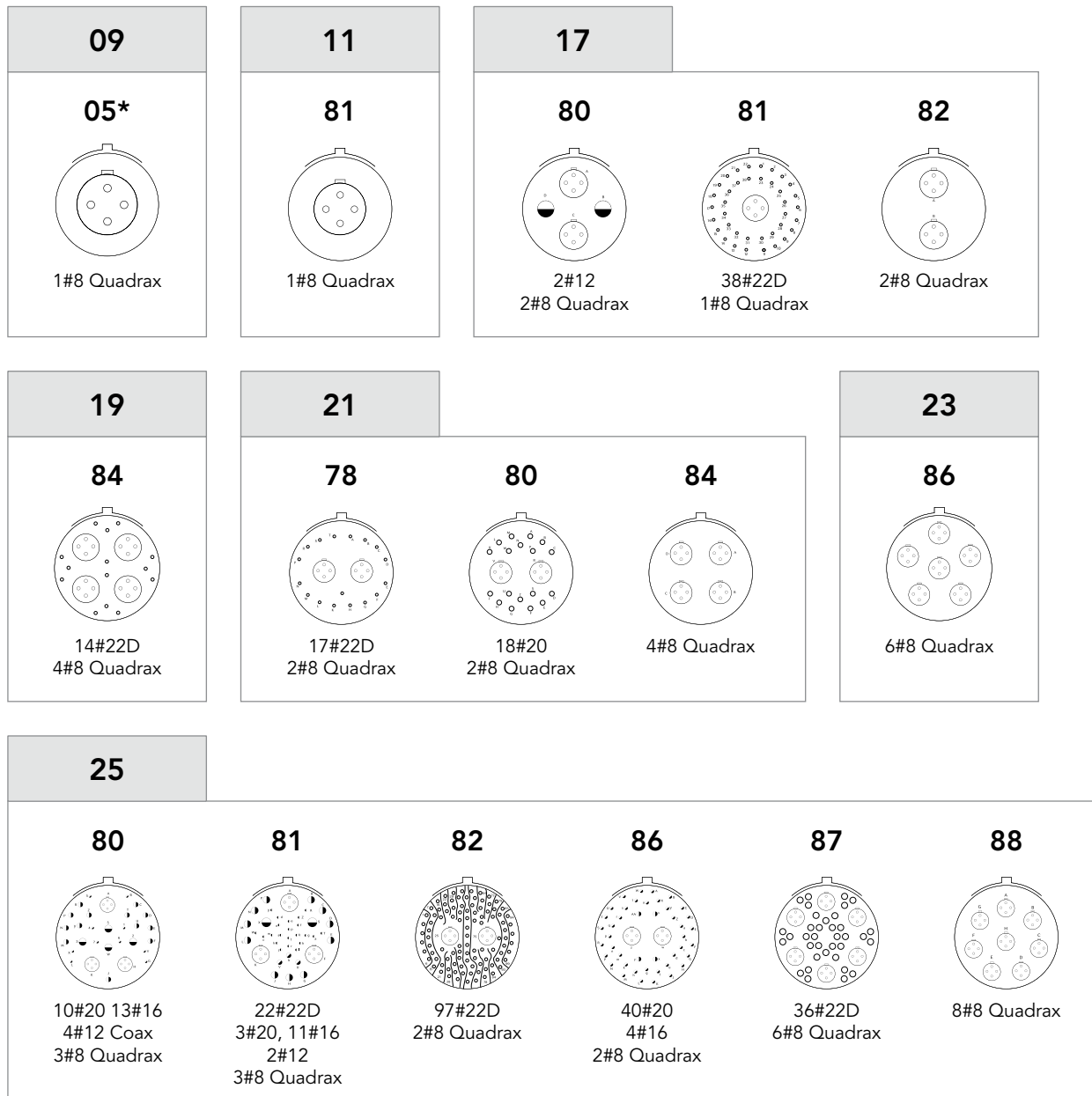

\* 09-05 layout with quadrax contact:  
 - grounded version only  
 - plug with female contact & receptacle with male contact only

Note: Mixed layouts not grounded.

## Dimensions

### Square flange receptacle - Type 0

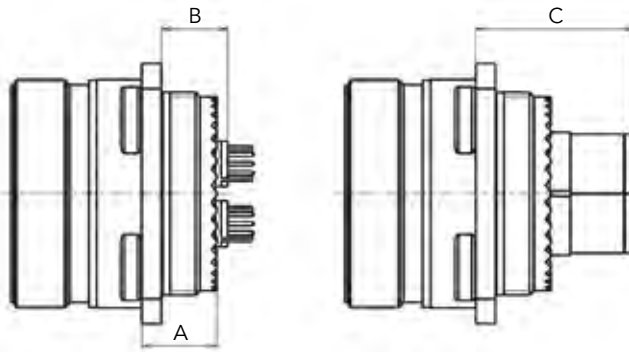

PC Tail contacts

Crimp contacts

Shell size	A Max			B Min			B Max			C Max
	Aluminum	Composite	Stainless steel, Titanium & Bronze	Aluminum	Composite	Stainless steel, Titanium & Bronze	Aluminum	Composite	Stainless steel, Titanium & Bronze	All materials
11 to 19	10.72	11.96	11.4	11.5	12.5	12	13.5	13.5	14	29
21 to 25	11.54	12.76	11.8	12	14.5	12.5	14	15.5	14.5	30

### Jam nut receptacle - Type 7

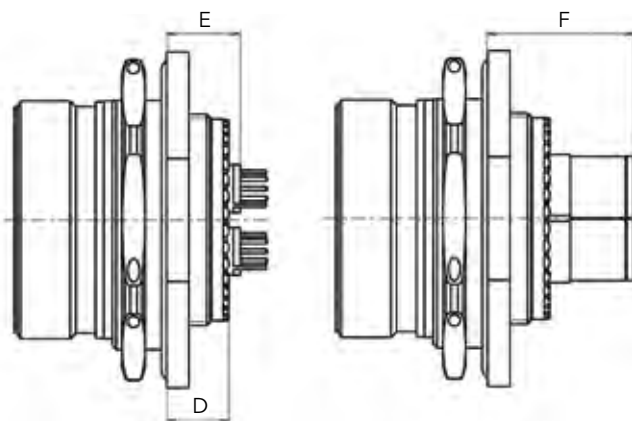

PC Tail contacts

Crimp contacts

Material	Aluminum, Stainless steel, Titanium & Bronze			
Shell size	D Max	E Min	E Max	F Max
11 to 25	9.9	9.5	12	27

### Plug - Type 5

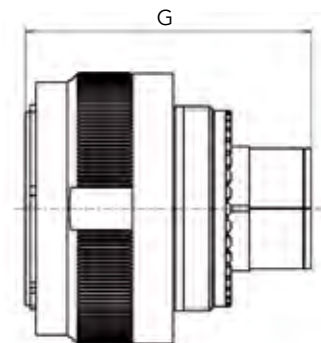

All materials	
Shell size	G Max
11 to 25	48

Note: All dimensions are in millimeters (mm)

### Quadrax crimp contact

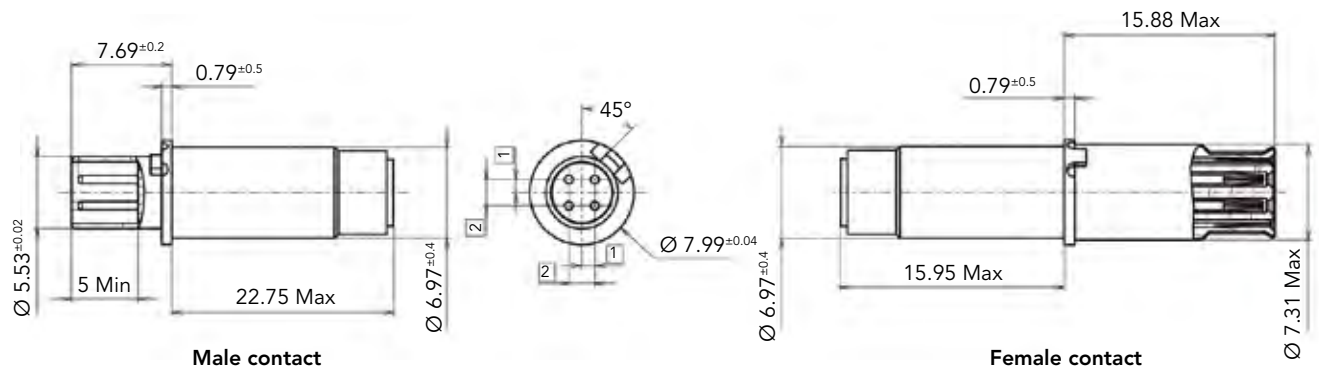

### Quadrax PCB contact

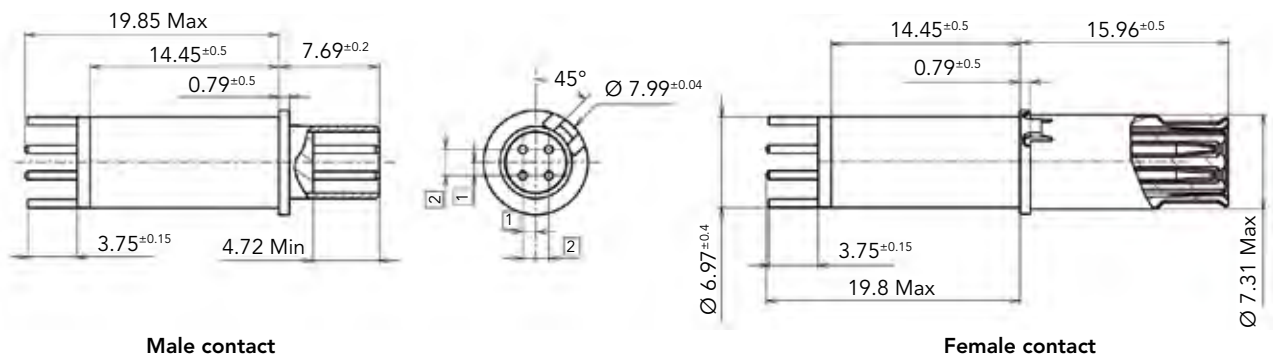

### Drill dimensions for PCB mount

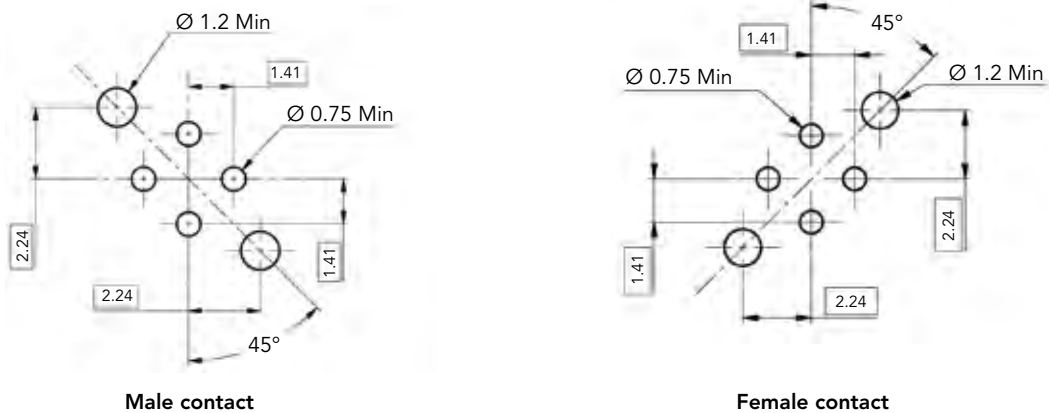

Note: All dimensions are in millimeters (mm)



## Contact ordering information

In-line alignment key. All crimp contacts are sealed thru a sealing boot. Crimp contacts ordered separately are delivered with sealing boot.

Contact type		SOURIAU part number	Cross Norm	Impedance	Release	T° Max
PC tail L= 4±0.1mm	Pin	ETH1-1237A	-	100Ω	Rear	125°C
		ETH1-1501A	-	150Ω	Rear	125°C
	Socket	ETH1-1238A	-	100Ω	Rear	125°C
		ETH1-1502A	-	150Ω	Rear	125°C
Crimp	Pin	ETH1-1345A	EN 3155-074	100Ω	Rear	150°C
		ETH1-1503A	-	150Ω	Rear	150°C
	Socket	ETH1-1346A	EN 3155-075	100Ω	Rear	150°C
		ETH1-1504A	-	150Ω	Rear	150°C

## Quadrax tools

Inner contacts: M22520/2-01 crimping tool and K709 locator

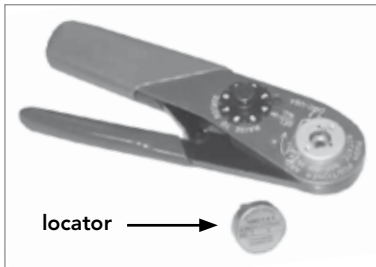

Outer body: M22520/5-01 crimping tool and M22520/5-45 die set

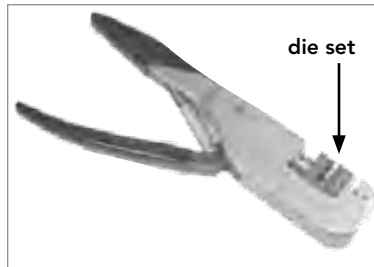

Insertion/extraction tool (standard size 8 cavity tools): 8660-197 (metallic) or M81969/14-06 (plastic)

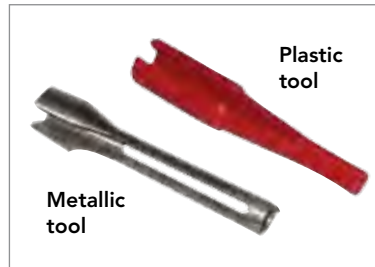

## Recommended cable

Cable type	Reference	Impedance	Number of pairs
Star quad	ABS 1503 KD24	100Ω	2



## Description

- Quick screw coupling connector with removable crimp contact
- Shell available in aluminum, composite, Stainless steel, Titanium & Bronze
- Six layouts with different current rating
- Consult us for power hermetic version
- High Power offer available on demand

## Technical features

### Mechanical

- **Shell:** Aluminum alloy, Composite, Bronze, Stainless steel, Titanium
- **Plating:**
  - . Olive green cadmium (W/J)
  - . Nickel (F/M/TF/S)
  - . Without plating (X for composite, TT for titanium and JVS for Bronze)
  - . Passivated (K)
- **Grommet and seal:** Silicon elastomer
- **Insulator:** Thermoset
- **Contact body:** Copper Alloy
- **Contact retention:**
  - . #4 = 200N
  - . #8 = 111N
- **Shock:** 300g during 3ms
- **Endurance:** 500 mating / unmating operations
- **Vibration:** As per MIL DTL 38999

### Electrical

- **Dielectric withstanding:** Test voltage rating (Vrms)

Service	Sea level	at 21 000 m
M	1 300	800
I	1 800	1 000

- **Insulation Resistance:** 5000 MΩ under 500 Vdc
- **Max current rating per contact:**
  - . #4 = 80A
  - . #8 = 45A
- **Contact resistance:**
  - . #4 = 2mΩ
  - . #8 = 3mΩ
- **Shielding:** As per MIL DTL 38999
- **Shell continuity:**
  - . W = 2.5 mΩ
  - . F = 1mΩ
  - . J, M = 3 mΩ
  - . JVS = 5 mΩ

### Environmental

- **Temperature range:**
  - . W, J, X, JVS = - 65°C +175°C
  - . F, M, K, S, TT, TF = - 65°C +200°C
- **Sealing:** As per MIL DTL 38999
- **Damp Heat:** As per MIL DTL 38999
- **Salt Spray:**
  - . W, TT, TF, K, JVS = 500 hours
  - . F, S = 48 hours
  - . J,M,X = 2000 hours
- **Fire resistance:** As per EN 2591 - C 17 method A
- **Resistance to fluid:** As per MIL DTL 38999

## Connector part numbers

### Aluminum, Composite, Stainless steel & Titanium connector

<b>Basic Series</b>	8D	0	-	11	W	80	P	N	251
<b>Style:</b>									
0: Square flange receptacle									
5: Plug with RFI shielding									
7: Jam nut receptacle									
<b>Type:</b> Crimp contact									
<b>Shell size:</b> 11 - 17 - 19 - 21 - 23 - 25									
<b>Plating:</b>									
<b>Aluminum shell:</b>									
W: Olive drab cadmium									
F: Nickel									
ZC: Green zinc cobalt									
Z: Black zinc nickel									
<b>Composite shell:</b>									
J: Olive green cadmium									
M: Nickel									
X: Without plating									
<b>Stainless steel shell:</b>									
K: Corrosion resistant									
S: Nickel									
<b>Titanium shell:</b>									
TT: Without plating									
TF: Nickel									
<b>Contact layouts:</b> See next page									
<b>Contact style:</b>									
P: Pin contact                      A: Male connector supplied without contact									
S: Socket contact                 B: Female connector supplied without contact									
<b>Orientation:</b> N - A - B - C - D - E									
<b>Specification:</b>									
251: Mandatory for some layouts supplied with power contacts (see next page)									



### Bronze connector

<b>Basic Series</b>	JVS	16	A	11	80	P	N	251
<b>Style:</b>								
00: Square flange receptacle								
07: Jam nut receptacle								
16: Plug								
<b>Material:</b>								
A: Bronze shell material								
<b>Shell size:</b> 11 - 17 - 19 - 21 - 23 - 25								
<b>Contact layouts:</b> See next page								
<b>Contact style:</b>								
P: Pin contact                      A: Male connector supplied without contact								
S: Socket contact                 B: Female connector supplied without contact								
<b>Orientation:</b> N - A - B - C - D - E								
<b>Specification:</b>								
251: Mandatory for some layouts supplied with power contacts (see next page)								

### Contact layouts

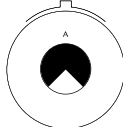
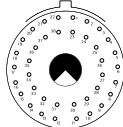
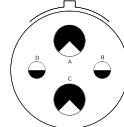
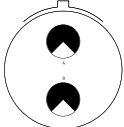
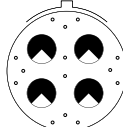
-  Contact #22D
-  Contact #12
-  Contact #20
-  Contact #8 Power
-  Contact #16
-  Contact #4 Power

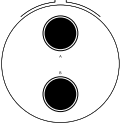
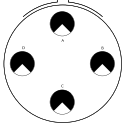
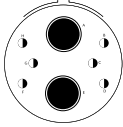
<b>11</b>				<b>17</b>			<b>19</b>
80 Spec 251	02 Spec 251	22 Spec 251	75 Spec 251			18 Spec 251	
							
1#8	38#22D 1#8	2#12 2#8	2#8			14#22D 4#8	

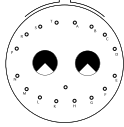
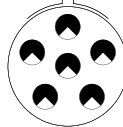
<b>21</b>						<b>23</b>	
20 Spec 251	42*	48*	72*	75 Spec 251	77 Spec 251	06 Spec 251	
							
18#20 2#8	2#4	4#8	6#16 2#4	4#8	17#22D 2#8	6#8	

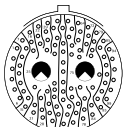
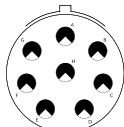
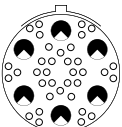
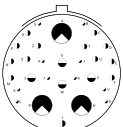
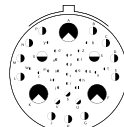
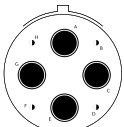
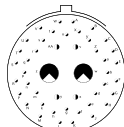
<b>25</b>						
07 Spec 251	08 Spec 251	17 Spec 251	20 Spec 251	41 Spec 251	44*	46 Spec 251
						
97#22D 2#8	8#8	36 #22D 6 #8	10#20 13#16 4#12 3#8	22#22D, 3#20 11#16, 2#12 3#8	4#16 4#4	40#20 4#16 2#8

\* Power contacts on standard, no spec. 251 needed.

**Power contacts**

Contact size	Contact type	Part number	Reducer	Cable size max.		Boot
				AWG	mm <sup>2</sup>	
#4	Male	85997598900*	Without	N/A	25 mm <sup>2</sup>	N/A not sealed
	Female	85997599900*				
	Male	85997534		AWG 4	16 to 21 mm <sup>2</sup>	85994594 for cable 16mm <sup>2</sup>
	Female	85997535				
	Male	85997524		AWG8	9 mm <sup>2</sup>	N/A not sealed
	Female	85997525				
	Male	85997534	85932000A	AWG6	10 mm <sup>2</sup>	85994593
	Female	85997535	Without	AWG6	10 mm <sup>2</sup>	
	Male	85997528900				
	Female	85997529900				
#8	Male	85997580	Without	AWG8	9 mm <sup>2</sup>	85994542
	Female	85997581				
	Male	85997580	85997645	AWG10	6 mm <sup>2</sup>	85994547
	Female	85997581				
#8 according to EN 3155	Male	85996215900	Without	AWG8	9 mm <sup>2</sup>	85994542
	Female	85996217900				
	Male	85996216900		AWG10	6 mm <sup>2</sup>	85994547
	Female	85996218900				
#8 JVS only	Male	85997544	Without	AWG8	9 mm <sup>2</sup>	85994542
	Female	85997541				
	Male	85997544	85997645	AWG10	6 mm <sup>2</sup>	85994547
	Female	85997541				

Cable section AWG	#22	#20	#16	#12	#10	#8	#4
mm <sup>2</sup> maxi	0.34	0.6	1.34	3.18	5.8	9	21
mm <sup>2</sup> mini	0.095	0.21	0.6	1.91	3.8	5.8	16

\* Not included in connector P/N. Must be ordered separately.

**Bus bar contact**

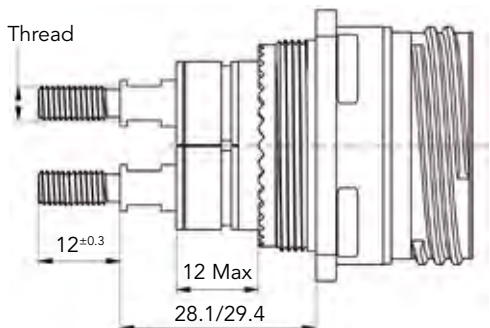

Contact size	Thread	Part number			Lug Ø
		Male	Female	Boots	
#4	M5x0.8	85930873A	85930875A	85994594	5.2
#8	M3x0.5	85930872A	85930874A	85994542	3.2

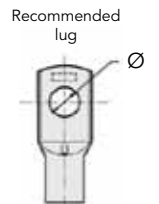

Contacts available separately only. Lug: tin over copper recommended. Dimensions for indication only.

Note: All dimensions are in millimeters (mm)

**Power tools**

Contact size	Contact type	Contact reference	Cable AWG	Crimping tool			Contact extraction tool (metallic)	Contact extraction tool (plastic)
				Automatic tool: M22520/23-01		Manual hand tool: M300 BT		
				Die set	Locator	Locator		
#4	Male	8599-7534	#4-5 or #10-16mm <sup>2</sup>	M22520/23-04	M22520/23-11	N/A	8533-8175	M81969/14-07
	Female	8599-7535						
#8 JVS only	Male	8599-7544	#8 or #10	M22520/23-02	8599-9601	SP 593	8660-197	M81969/14-12
	Female	8599-7541						
#8	Male	8599-7580						
	Female	8599-7581						

**Automatic tool for contacts #4 & #8**



Crimping tool M22520/23-01



Die set



Locator

**Manual hand tool for contacts #8**



Crimping tool M300 BT



Locator

**Extraction tool**



Metallic tool

## Description

- Threaded coupling connector with single power contact
- Aluminum shell
- 3 shell sizes available:
  - size 19: Up to 450 A at 40°C
  - size 23: Up to 650 A at 40°C
  - size 25: Up to 850 A at 40°C
- Silver plated contact
- Pin contact is equipped with a plastic cap to prevent electrical shock
- Modular design:
  - . Removable backshell: straight, right angle or threaded contact
  - . Backshell termination: shrink boot

## Technical features

### Mechanical

- **Shell:** Aluminum alloy
- **Shell plating:**
  - Black zinc nickel (Z)
  - Cadmium olive drab (W)
- **Insulator:** Thermoplastic
- **Grommet and interfacial seal:** Silicone elastomer
- **Contact body:** Copper alloy
- **Endurance:** 500 mating/unmating operations
- **Vibration:**
  - According Def Stan 00-35
  - 4.2 g rms vert - 6h/3 axes

### Electrical

- **Test voltage** > 1500 V
- **Shell to shell continuity** (no backshell) < 2.5 mΩ
- **EMI** 85 dB @ 1GHz (F)

### • Connector rating

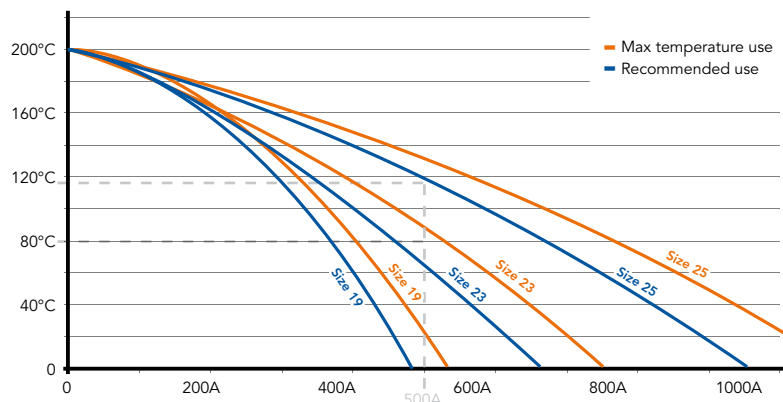

Example for 500A:  
 Shell size 25 with contact diameter 20: max temperature 135°C; recommended 120°C  
 Shell size 23 with contact diameter 18: max temperature 90°C; recommended 80°C  
 Shell size 19 with contact diameter 14: not recommended  
 Wire must be compatible with current and temperature used for the connector.

### Environmental

- **Temperature range:** -65°C +175°C
- **Sealing:** IP67 on mated connector (1 meter/30 min)
- **Salt spray:** 500 hours

### Resistance to fluids

- **According to MIL-DTL-38999 standard**
  - . Gasoline: JP5 (OTAN F44)
  - . Mineral hydraulic fluid: MIL-H-5606 (OTAN H515)
  - . Synthetic hydraulic fluid: Skydrol 500 B4
- **LD4 (SAE AS 1241)**
  - . Mineral lubricating: MIL-L-7870A (OTAN 0142)
  - . Synthetic lubricating: MIL-L-23699 (OTAN 0156), MIL-L-7808
  - . Cleaning fluid: MIL-C-87936 diluted
  - . De-icing fluid: MIL-A-8243
  - . Extinguishing fluid: Bromochloromethane
  - . Cooling fluid: Coolanol

## Contact layouts

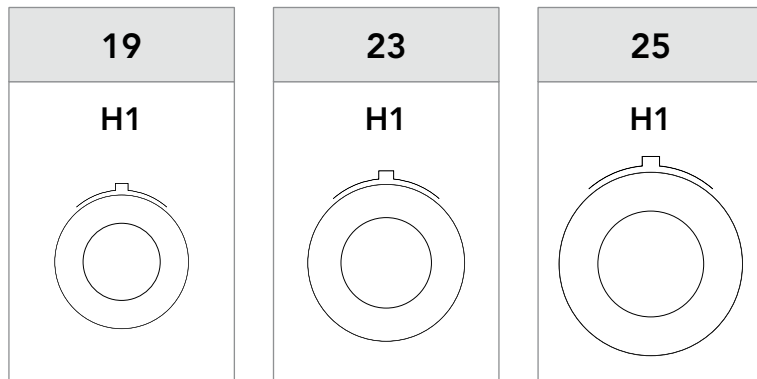

Other size: Please consult us.

## Ordering information

<b>Basic Series</b>	<b>8D</b>	<b>0</b>	<b>25</b>	<b>W</b>	<b>H1</b>	<b>P</b>	<b>N</b>	<b>R1</b>	<b>A</b>
<b>Style:</b>									
0: Square flange receptacle									
5: Plug (available with backshell D1, R1, G0 & W0 Types)									
7: Jam nut receptacle									
<b>Shell size: 19, 23, 25</b>									
<b>Plating:</b>									
Z: Zinc Nickel									
W: Olive green cadmium									
<b>H1: Single power</b>									
<b>Contact style:</b>									
P: Pin contact									
S: Socket contact									
<b>Orientation: N, A, B, C, D, E</b>									
<b>Backshell type:</b>									
D1: Straight backshell shrink boot & EMI (crimp version)									
R1: Right angle backshell shrink boot & EMI (crimp version)									
G0: Backshell low profile (threaded termination)									
W0: Without backshell (threaded termination)									

### Specification for backshells D1 & R1 Types (crimp version):

Specification	Shell size	Admissible cable (mm)		Barrel diameter (mm $\pm 0.05$ )
		Outer $\varnothing$ max	Nominal core $\varnothing$	
A	19	17	10.15	10.8
B	19	17	11.1	11.8
C	19	17	12	12.5
D	23	22	14.05	15
E	23	22	16.3	17
	25	26.5		
F	25	26.5	19	20.5

### Specification for backshells G0 & W0 Types (only threaded termination):

Specification	Shell size	Thread
C	19, 23 & 25	M12

Note: Plug not available with backshell W0 Type. Other thread, please consult us.

Note: For other configuration, please consult us.



## Backshell type

Description		
D1: Straight backshell shrink boot & EMI (crimp version)	G0: Backshell low profile (threaded termination)	R1: Right angle backshell shrink boot & EMI (crimp version)
	W0: Without backshell (threaded termination)	

## Dimensions

Plug & receptacles									
8D0 Square flange receptacle			8D5 Plug			8D7 Jam nut receptacle			
Shell size	A $\pm 0.1$	B $\pm 0.1$	C $\pm 0.1$	D $\pm 0.1$	E $\pm 0.1$	F Max	ØG Max	H $\pm 0.25$	ØJ $\pm 0.25$
19	36.5	26.97	29.36	3.29	4.98	41	38.5	45.95	49.15
23	42.9	31.75	34.93	3.96	6.2	47	44.9	52.35	55.55
25	46	34.93	38.1			52	48	55.55	58.65

Note: All dimensions are in millimeters (mm)

### Backshell D1 type

With 8D0  
(square flange receptacle)

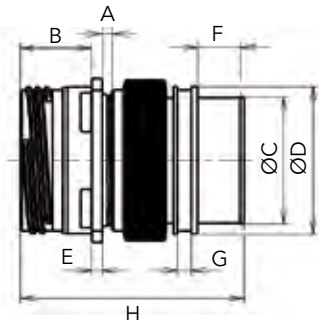

With 8D5  
(plug)

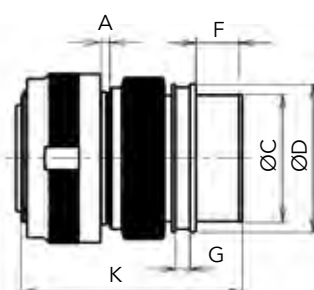

With 8D7  
(jam nut receptacle)

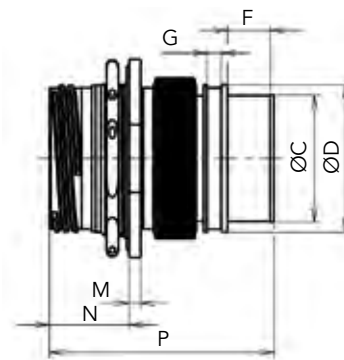

Shell size	A Max	B Max	ØC±0.1	ØD±0.1	E±0.1	F±0.2	G±0.2	H Max	K Max	M±0.25	N Max	P Max
19	2.65	20.9	25.6	31.6	2.26	12	4	62.5	62	3.25	22.8	63
23		20.1	32.4	38.6	2.97							
25		35.6	42.1	2.97								

### Backshell R1 type

With 8D0  
(square flange receptacle)

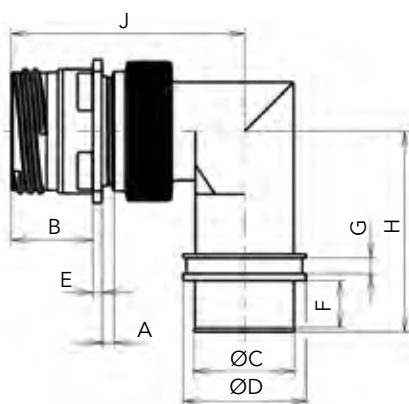

With 8D5  
(plug)

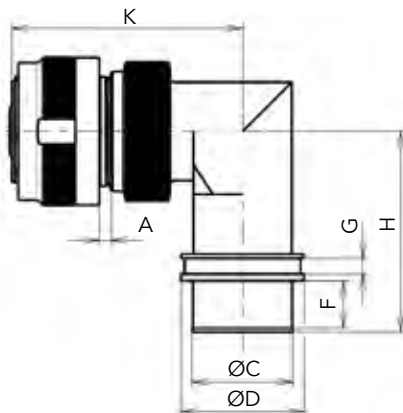

With 8D7  
(jam nut receptacle)

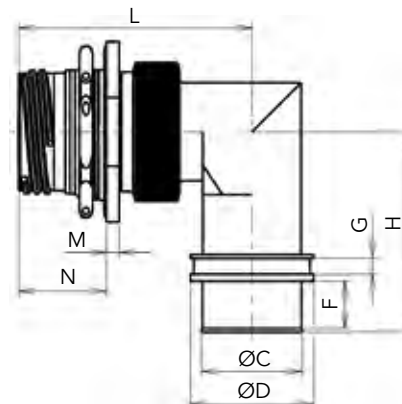

Shell size	A Max	B Max	ØC±0.1	ØD±0.1	E±0.1	F±0.2	G±0.2	H Max	J Max	K Max	L Max	M±0.25	N Max
19	2.85	20.9	25.6	31.3	2.26	12	4	51.1	59.8	59.3	59.8	3.25	22.8
23		20.1	32.4	38.1	2.97			54.4	63.2	62.7	63.2		
25		35.6	41.3	2.97	56.1			64.8	64.3	64.8			

Note: All dimensions are in millimeters (mm)

**Backshell G0 type**

With 8D0  
(square flange receptacle)

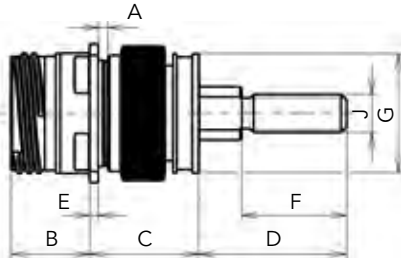

With 8D5  
(plug)

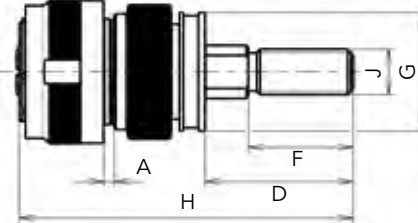

With 8D7  
(jam nut receptacle)

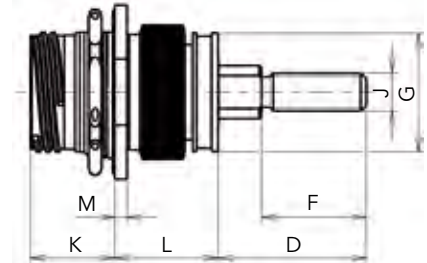

Shell size	A Max	B Max	C Max	D Max	E $\pm$ 0.1	F $\pm$ 0.2	$\varnothing$ G $\pm$ 0.1	H Max	J Max	K Max	L Max	M $\pm$ 0.25
19	2.65	20.9	29	39.4	2.26	25	31.3	88.1	M12 x 1.75	22.6	27.6	3.25
23		20.1	29.8		2.97		38.1				28.4	
25					2.97		41.3				28.4	

**Backshell W0 type**

With 8D0  
(square flange receptacle)

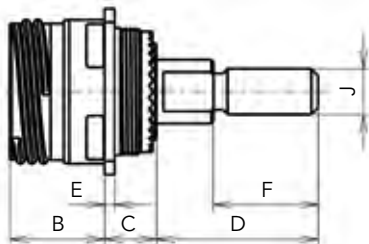

With 8D7  
(jam nut receptacle)

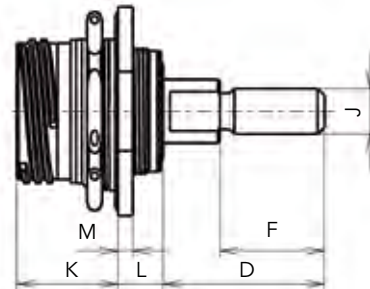

Shell size	B Max	C Max	D Max	E $\pm$ 0.1	F $\pm$ 0.2	J Max	K Max	L Max	M $\pm$ 0.25
19	20.9	14	40	2.26	25	M12 x 1.75	22.6	12	3.25
23	20.1			2.97					
25				2.97					

Note: All dimensions are in millimeters (mm)

## Description

- Quick screw coupling D38999 connector
- Shell available in aluminum, composite, Stainless steel, Titanium & Bronze
- 16 layouts available with coaxial contact
- High Frequency coaxial contact: DC 18GHz
- Qualified coaxial contact according to MIL-STD-348A/321
- Removable coaxial contact
- Contacts delivered with boots

## Technical features

### BMA contact features For .086" flexible cable

#### Electrical

- **Impedance:** 50Ω
- **Frequency range:** DC 18GHz
- **Dielectric withstanding voltage:** 1.5 kVrms, 50Hz (at sea level)
- **Insulation resistance:** ≥ 5 000 MΩ
- **Contact resistance:**
  - . center contact: ≤ 2 mΩ
  - . outer contact: ≤ 2 mΩ
- **Return loss (DC-18GHz):** < -17dB (mated connector)
- **RF leakage interface only (fully mated):** ≥ 90 dB f (GHz) measured at interface with reference planes being in true alignment.
- **RF testing voltage:** 1.0 kVrms, 5 MHz (at sea level)
- **Admissible power:** ≤ 300 W at 3 GHz (at sea level & room T°)

#### Environmental

- **Temperature range:** -65°C +125°C
- **Thermal shock:** MIL-STD-202, method 107, condition B

- **Moisture resistance:** MIL-STD-202, method 106
- **Corrosion:** Salt spray test according to MIL-STD-202, method 101, condition B
- **Vibration:** MIL-STD-202, method 204, condition D
- **Shock:** MIL-STD-202, method 213, condition I

/!\ Caution: be careful that your application doesn't exceed contact specification.

## Connector features

### Mechanical

- **Shell material & plating:**
  - . Aluminum: Cadmium olive drab (W)  
Nickel (F)  
Black zinc nickel (Z)  
Green zinc cobalt (ZC)
  - . Composite: Cadmium olive drab (J)  
Nickel (M)  
Without plating (X)
  - . Stainless steel: Passivated (K)  
Nickel (S)
  - . Titanium: Without plating (TT)  
Nickel (TF)
  - . Bronze: Without plating
- **Insulator:** Thermoplastic
- **Grommet and interfacial seal:** Silicone elastomer
- **Contact endurance:** 1000 mating cycles
- **Connector endurance:** 500 mating cycles

- **Shock:** 300g, 3 ms (EN 2591-D2 method A)
  - **Vibration:**
    - . Sinus:
      - . 10 à 2000 Hz, 3x12 hrs (60g, 140 - 2000 Hz) with T° cycling
    - . Random:
      - . 50 to 2000 Hz, 2x8 Hrs (1g2/ Hz, 100 - 2000Hz) at T° max.
      - . 25 to 2000 Hz, 2x8 Hrs (5g2/ Hz, 100 - 300Hz) at ambient T°
- Test with accessories in acc with EN2591-D3

## Electrical





- **Shell continuity:**
  - . F, S & TF: 1 mΩ . J & M: 3 mΩ
  - . W, Z & ZC: 2.5 mΩ . Bronze: 5 mΩ
  - . K & TT: 10 mΩ
- **Shielding:**
  - . F & M: 85 db at 1 GHz
  - . K & TT: 45 db at 10 GHz
  - . W & Z: 50 db at 10 GHz
  - . F, S & TF: 65 db at 10 GHz
  - . Bronze: 85 db at 10 GHz
  - . J: 90 db at 10 GHz
  - . ZC: Consult us

## Environmental

- **Temperature range:**
  - . W, ZC, J, X & bronze: -65°C +175°C
  - . F, Z, M, K, S, TT & TF: -65°C +200°C
- **Salt spray:**
  - . F, S & TF: 48 Hours
  - . ZC: 250 Hours
  - . W, Z, K, TT & bronze: 500 Hours
  - . J, M & X: 2000 Hours

### Contact layouts

Specification 737 mandatory

-  Contact #22D
-  Contact #20
-  Contact #16
-  Contact #12
-  Contact #8 Coax

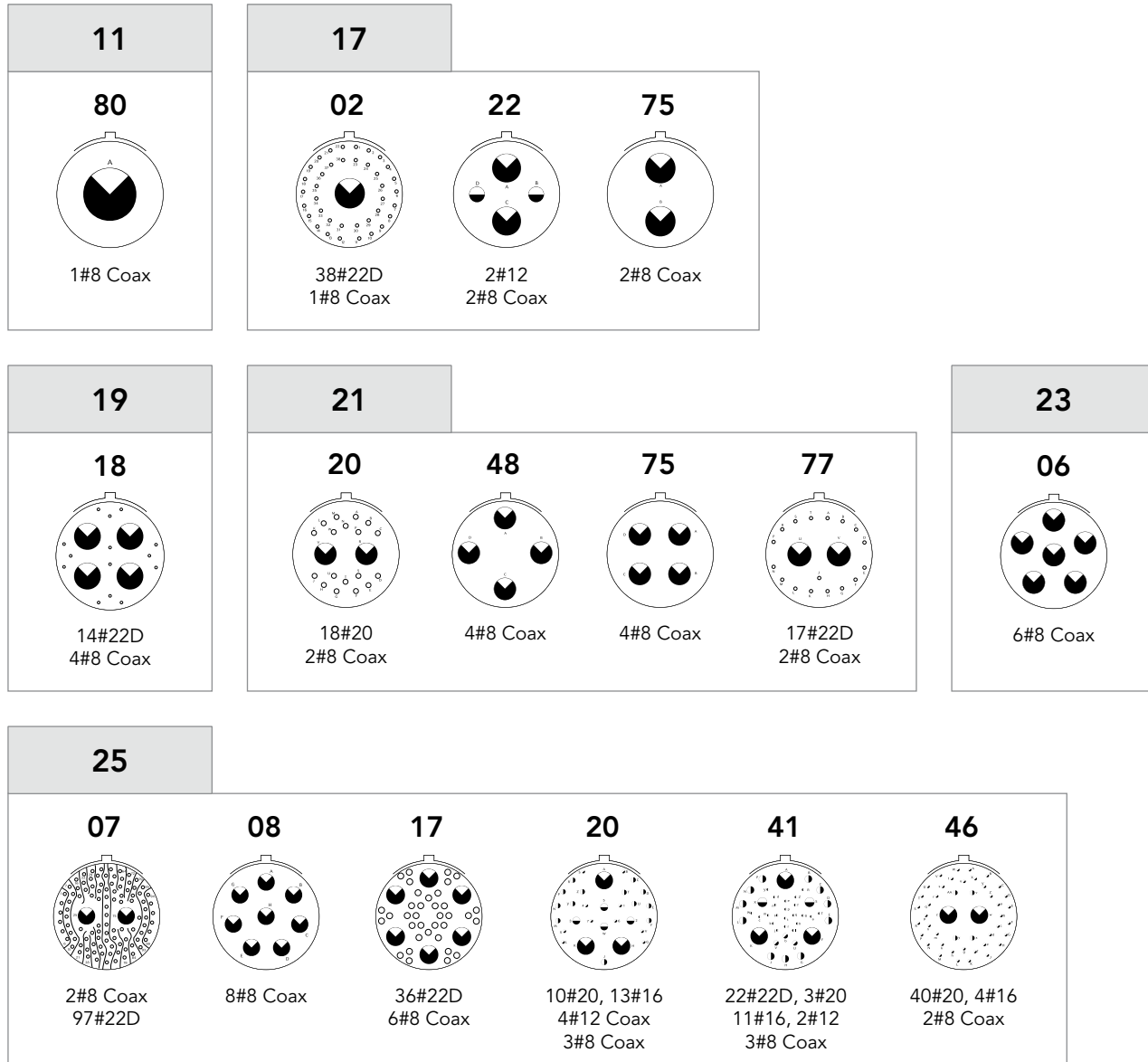

## Ordering information

<b>Basic Series</b>	<b>8D</b>	<b>0</b>	<b>25</b>	<b>W</b>	<b>46</b>	<b>P</b>	<b>N</b>	<b>737</b>
<b>Shell style:</b>								
0: Square flange receptacle								
1: In line receptacle								
7: Jam nut receptacle								
5: Plug with RFI shielding								
<b>Shell size:</b>								
11, 17, 19, 21, 23, 25								
<b>Aluminum plating:</b>								
W: Olive drab cadmium								
F: Nickel								
Z: Black zinc nickel								
<b>Contact layout:</b>								
See previous page								
<b>Contact type:</b>								
P: Pin								
S: Socket								
<b>Orientation:</b>								
N, A, B, C, D, E								
<b>Specification (mandatory):</b>								
737: Coaxial contacts - for .086" flexible cable								
747: Coaxial contacts - for .141" flexible cable								

For other material and configuration (integrated clinch nuts, double flange, other cables, ...) please consult us.

## Recommended cables

Designation	Part number	Description	
.086" flexible cable	Multiflex 86	Outer conductor contact	Soldered
.141" flexible cable	Multiflex 141		

For other cables please consult us.

## Assembly Instruction

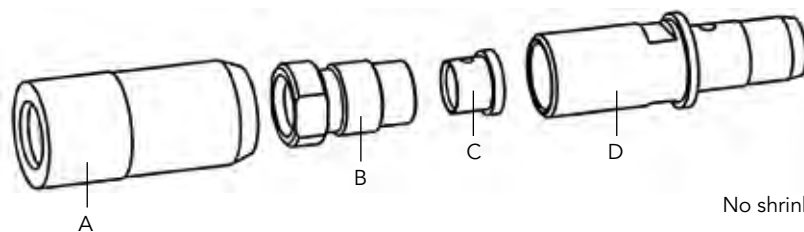

No shrinking sleeve allowed.

Picture	Process	Feature / Check	Tools required
	<p>Dip the cut length of cable in flux and tin.</p> <p>Cut the jacket to the braid. Remove jacket.</p>	<p>The solder must flow at rear for min. 7 mm.</p>	<p>Stanley blade</p>
	<p>Remove cable dielectric and tinned braid according to diagram.</p> <p>Form tip of centre contact to a 90° cone.</p> <p>Slide Taper sleeve A and nipple B over cable.</p>	<p>Do not damage inner conductor, dielectric and braid of cable.</p>	<p>Stanley blade Tip trimmer</p>
	<p>Slide ferrule C over cable, flush to dielectric.</p> <p>Solder at X.</p> <p>Avoid excessive heat, immediately cool down and clean with alcohol.</p>	<p>If the cable does not fit into the cable entry, use a flat-nose plier to calibrate the braid.</p> <p>Center conductor of cable must be exactly centered.</p>	<p>Soldering iron Solder Flat-nose pliers</p>
	<p>Push prepared cable into connector body D and tighten nipple B.</p> <p>Taper sleeve A will be used for MIL-connector.</p>	<p>Torque: 3 Nm.</p>	<p>Male contact: Torque wrench AF.6 (3 Nm) Spanner AF.5.5</p> <p>Female contact: Torque wrench AF.6 (3 Nm) Spanner AF.6</p>

## Description

- Robust spring-loaded butt-joint optical contact using ST style ferrule (diameter 2.5mm)
- Contact size equivalent to a #16 contact
- Anti-rotation of the contact for better vibration withstanding and optical performance
- Boot-grommet for rear sealing and protection of the cable against excessive bending
- Compatibility with loose and tight structure cables
- High level optical performance even after aging
- Bayonet locking system: no tool needed for mounting/dismounting
- Compatible with singlemode, multimode and POF cable

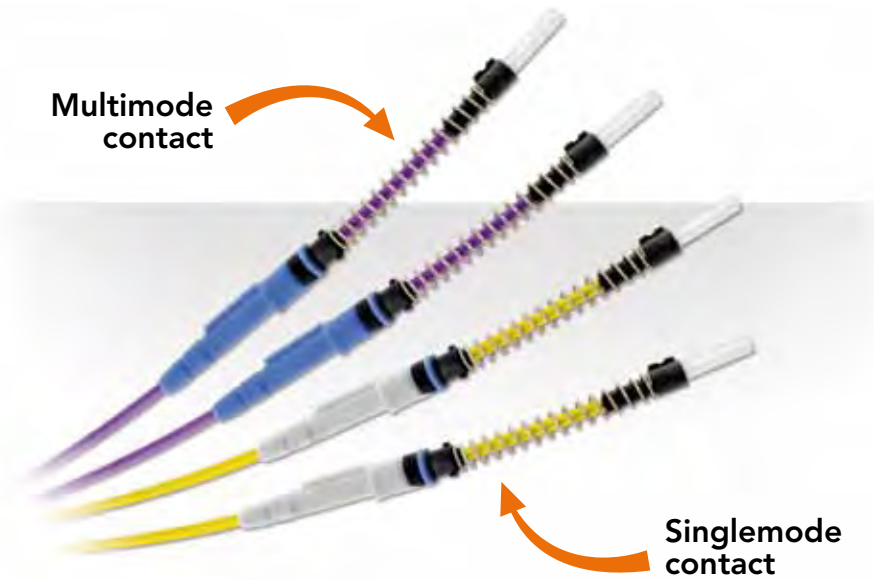

## Technical features

### Optical

- **Multimode contact - Insertion Loss (IL):**  
0.1dB typical  
< 0.3dB over 95% of the samples as per EN2591-601,  
< 0.7dB maximum on 100% of the samples after tests
- **Multimode contact - Return Loss (RL):**  
> 21dB before and after tests as per EN2591-605
- **Singlemode contact - Insertion Loss (IL):**  
0.3dB typical  
< 0.5dB over 95% of the samples as per EN2591-601,  
< 0.9dB maximum on 100% of the samples after tests
- **Singlemode contact - Return Loss (RL):**  
> 55dB typical and > 50dB minimum

### Mechanical

- **Endurance:**  
Minimum 500 mating/unmating operations
- **Vibration:**  
In MIL-DTL-38999 Series III/EN3645 connectors:  
. Sine 5Hz to 3000Hz as per EN2591-6403 method A  
. Random as per EN2591-6403 method B

- **Shock:**  
300g, 3 ms as per EN 2591-6402 method A
- **Cable cyclic flexing\*:**  
100 cycles, load 40N as per EN2591-609
- **Cable pulling\*:** 111N
- **Cable torsion\*:**  
100 cycles, load 40N as per EN2591-611

\* With multimode EN4641-100 cable and following the cabling process described in the "Technical Bulletin N°204 - ELIO® assembly wiring instructions" and the maintenance procedure in the document "Technical Bulletin N°170 - Fiber optics installation and maintenance procedure".

### Environmental

- **Salt spray:** See the connector standard
- **Temperature range\*:**  
- 65°C to +125°C (1000 hours)
- **Rapid temperature change:**  
10 cycles - 65°C / +150°C (30min/30min)
- **Air leakage:**  
Max leakage 16 cm³/h, 2 hours,  
40kPa differential pressure
- **Damp heat and low temperature:**  
5 cycles of 48h -65°C/+70°C with stage at 40°C with 95% of humidity as per EN2591- 6303 method A

### Resistance to fluids

as per MIL-DTL-38999/EN3645 standard

- **Fuel:** JP5
- **Mineral Hydraulic fluid:**  
MIL-PRF-5606 ( NATO H-515)
- **Synthetic hydraulic fluid:**  
AS1241 (Skydrol 500B4, LD4)
- **Mineral lubricant:**  
MIL-PRF-7870 (NATO O-142)
- **Synthetic lubricant:**  
MIL-PRF-23699 (NATO O-156),  
MIL-PRF-7808 ( NATO O-148)
- **Cleaning fluid:**  
MIL-PRF-87937 diluted, Propanol, white spirit, Azeotrope R113 + Methanol
- **De-icing fluid:** AMS 1424 ( NATO S-742)
- **Extinguishing fluid:** Bromochloromethane
- **Cooling fluid:** Coolanol



## Ordering information

### ELIO® multimode & singlemode contact

ELIO	09N	G	L	A
<b>Cable external diameter &amp; Contact sealing:</b>				
09N: 0.9±0.1mm. Non waterproof				
18N: from 1.5mm to 1.9mm. Non waterproof				
18W: 1.8±0.1mm. Waterproof				
20N: from 1.7mm to 2.1mm. Non waterproof				
20W: 2.0±0.1mm. Waterproof				
<b>Fibre type:</b>				
G: ELIO® Multimode				
E: ELIO® Singlemode				
<b>Boot type:</b>				
L: Long boot				
S: Short boot				
N: No boot (non waterproof version only)				
<b>Contact version index</b>				



Note: For ABS1379/EN4531 cross reference, please consult us.

### ELIO® contact dimensions

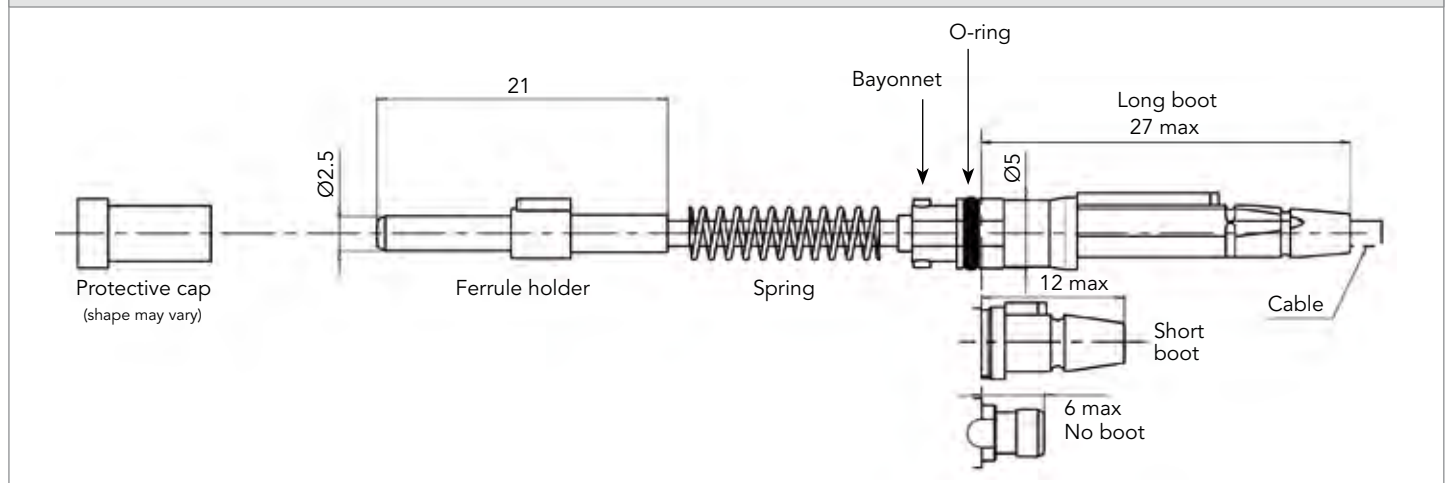

### Recommended cables

SOURIAU can offer a wide range of cables in its assemblies, from low cost to high performance aeronautical cables. ELIO® contact is compatible with singlemode and multimode cable, with tactical and breakout cable. ELIO® contact is suitable with loose and tight structure cable.

See Souriau "ELIO® Fiber Optic Technology» catalog.

Note: All dimensions are in millimeters (mm)

**MIL-DTL-38999  
Series III/EN3645  
with ELIO® high density insert**

- Standard MIL-DTL-38999/EN3645 shells without shielding ring (aluminum, composite, stainless steel, bronze)
- Environmental performance as per EN4531 based on MIL-DTL-38999/EN3645
- Temperature range: - 65°C to +125°C (cable limitation)

**Contact layouts**

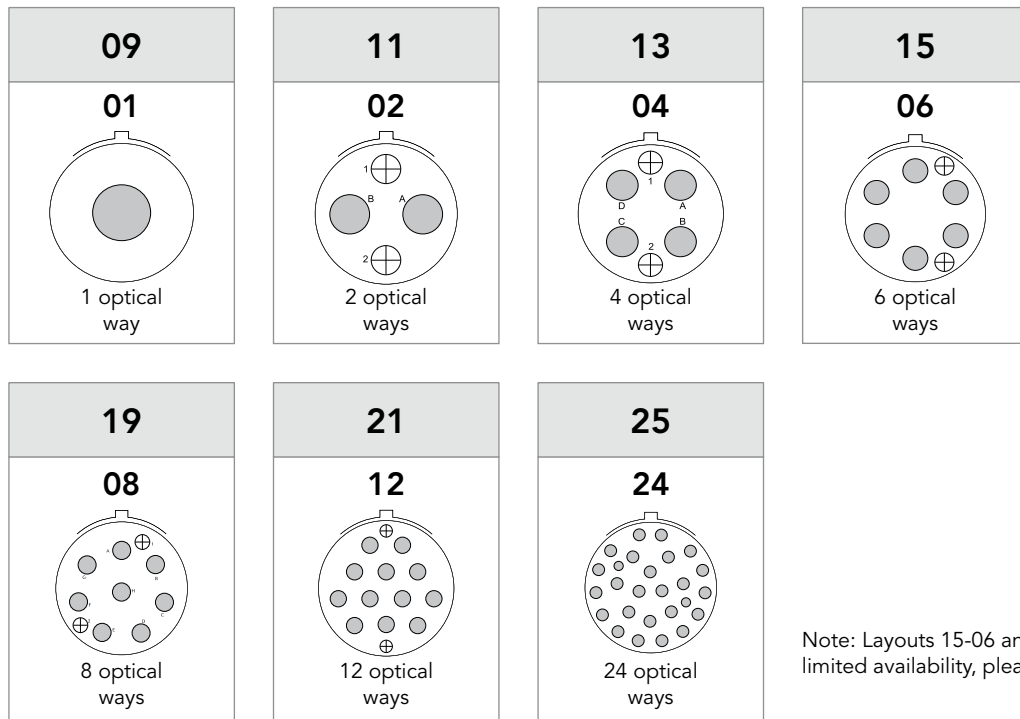

Note: Layouts 15-06 and 21-12: limited availability, please consult us.

**Ordering information, Accessories & Tooling**

See Souriau "ELIO® Fiber Optic Technology» catalog.

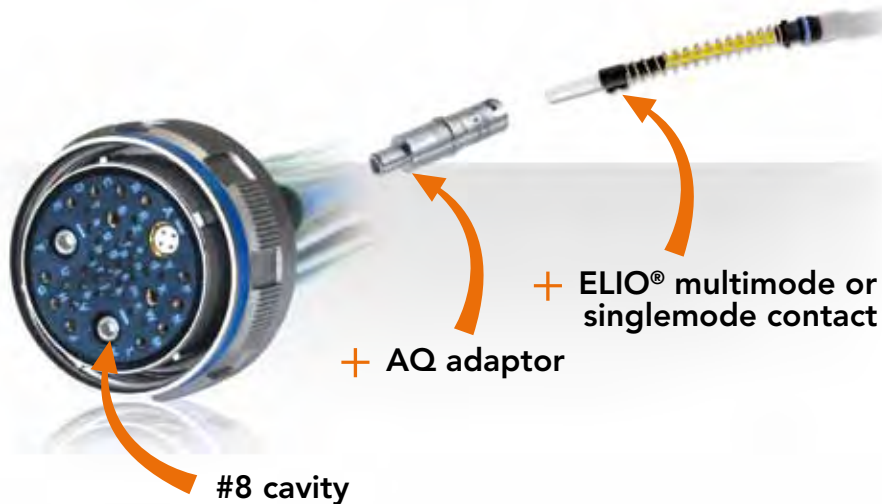

**MIL-DTL-38999  
Series III/EN3645**  
with ELIO® contact multimode or  
singlemode + ELIO® AQ Adaptor  
for Quadrax #8 cavities

- ELIO® AQ is an adaptor to enable the ELIO® contact to fit in any #8 cavities
- Multiple possibilities to mix optical and electrical signals in the same insert
- Compatible with standard MIL-DTL-38999 Series III/EN3645 connectors (aluminum, composite, stainless steel, bronze)
- Design ensures ELIO® optical performance
- Environmental performance as per MIL-DTL-38999 and EN3645 standard
- Temperature range: - 65°C to +150°C (cable limitation)

**Contact layouts**

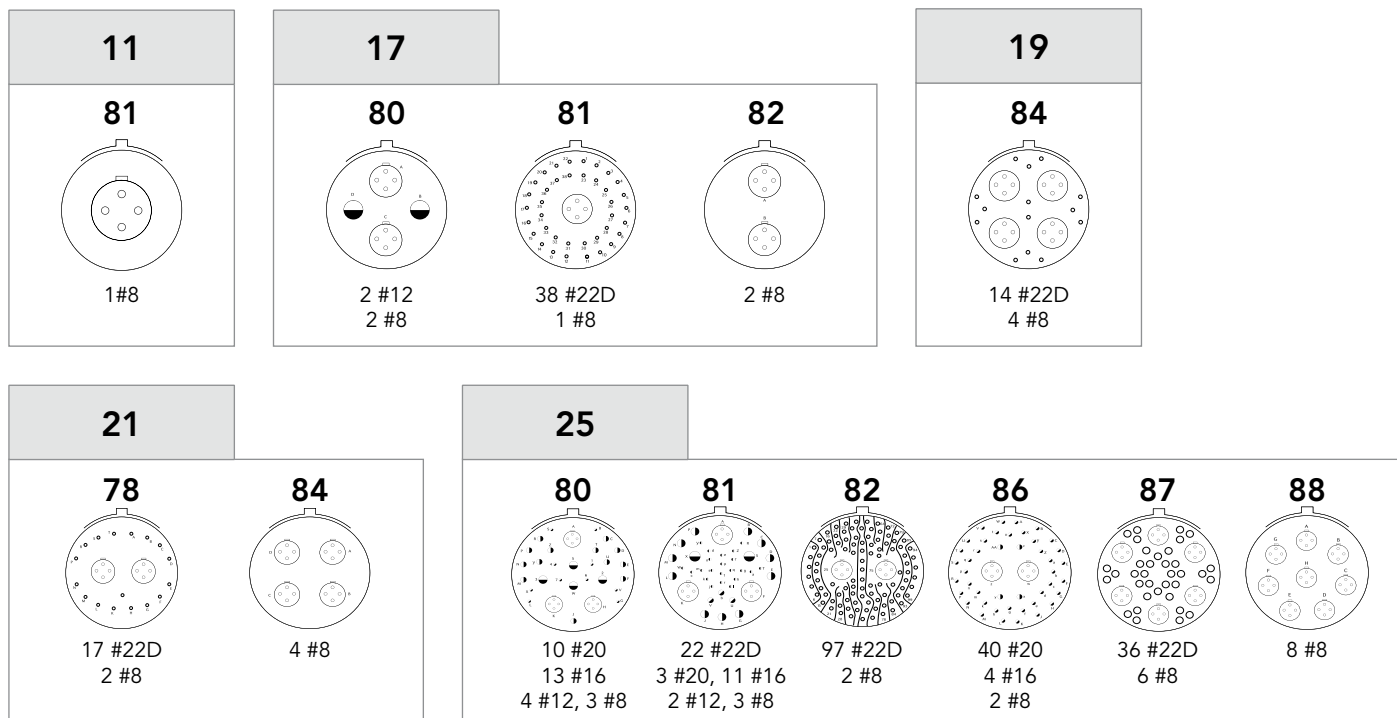

**Ordering information, Accessories & Tooling**

See Souriau "ELIO® Fiber Optic Technology» catalog.

### Dimensions

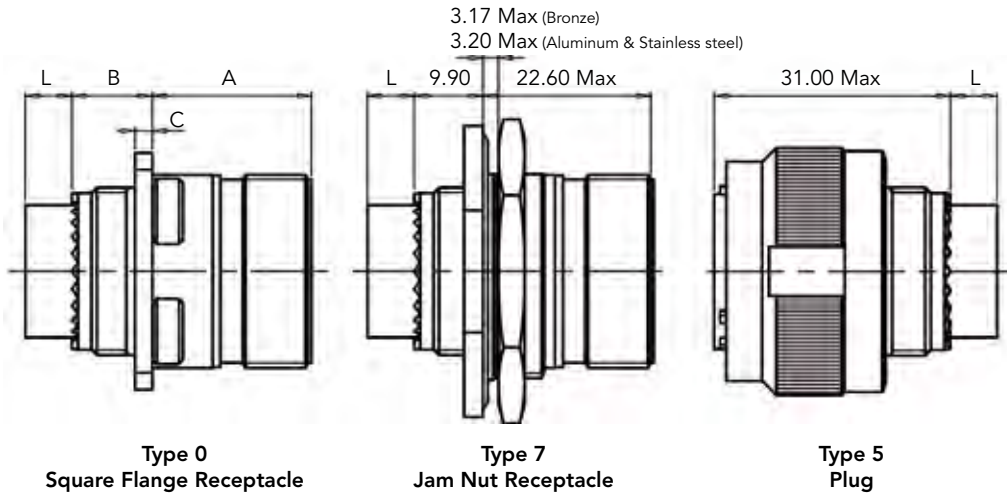

	A		B		C	
	Shell size 09 to 19	Shell size 25	Shell size 09 to 19	Shell size 25	Shell size 09 to 19	Shell size 25
Receptacle Type 0 & 7 Metal	20.90 Max	20.10 Max	12.50 Max	13.00 Max	2.50 Max	3.20 Max
Receptacle Type 0 Composite	20.90 Max	20.10 Max	12.50 Max	13.00 Max	3.65 Max	4.35 Max

L	
Male insulator	Female insulator
4 Max	6.60 Max

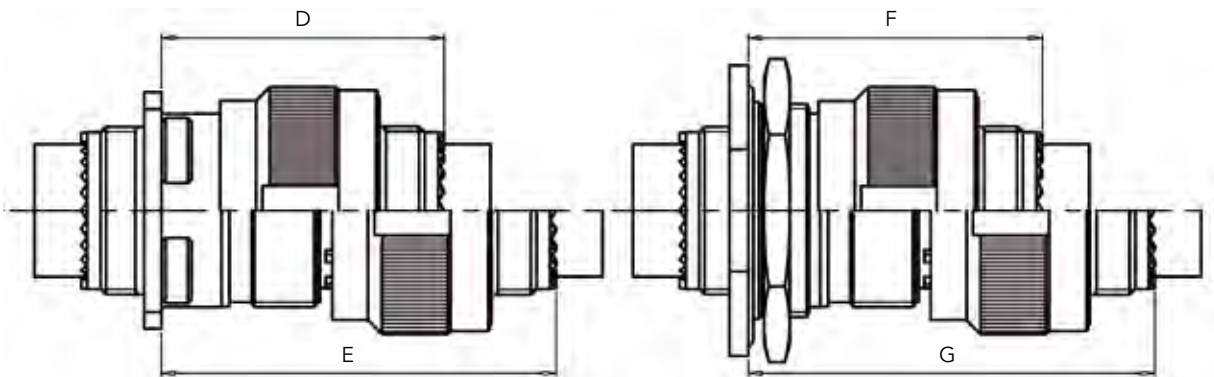

	D		E		F		G	
	Shell size 09 to 19	Shell size 25	Shell size 09 to 19	Shell size 25	Shell size 09 to 11	Shell size 13 to 25	Shell size 09 to 11	Shell size 13 to 25
Plug + Receptacle Type 0 & 7 Metal	37.00 Max	36.50 Max	52.30 Max	51.50 Max	39.00 Max	39.00 Max	54.00 Max	54.00 Max
Plug + Receptacle Type 0 Composite	37.00 Max	36.50 Max	52.30 Max	51.50 Max	N/A	N/A	N/A	N/A

Note: All dimensions are in millimeters (mm)

**Dimensions**

**38999 Series III/EN3645 with ELIO® contacts in ELIO® high-density insert**

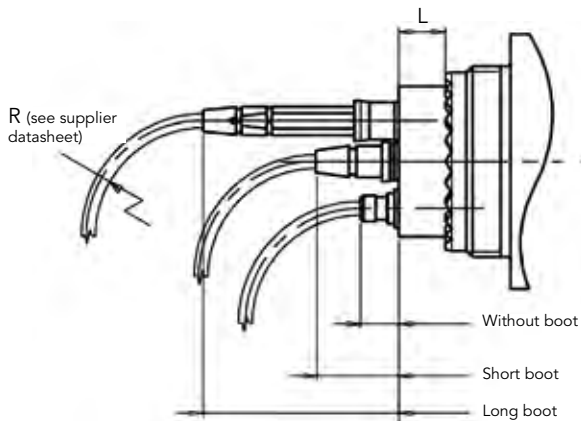

**38999 Series III/EN3645 with ELIO® contacts in ELIO® AQ adaptors**

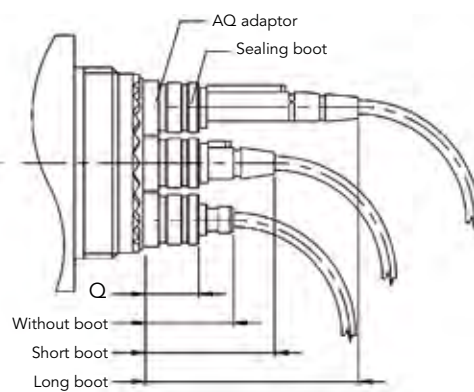

	ELIO® high density insert					ELIO® AQ adaptors							
	L		Contact length			Q		Contact length					
	Male insulator	Female insulator	Without boot	Short boot	Long boot	Male insulator	Female insulator	Long boot		Short boot		Without boot	
								Male insulator	Female insulator	Male insulator	Female insulator	Male insulator	Female insulator
<b>Plug</b>						12 Max	9.5 Max	34.5 Max	32 Max	19.5 Max	17 Max	12.5 Max	10 Max
<b>Square flange receptacle</b>	4 Max	6.60 Max	6 Max	12 Max	27 Max	12.5 Max	10 Max	35 Max	32.5 Max	20 Max	17.5 Max	13 Max	10.5 Max
<b>Jam nut receptacle</b>						12 Max	9.5 Max	34.5 Max	32 Max	19.5 Max	17 Max	12.5 Max	10 Max

**Total length example**

Square flange receptacle + plug + ELIO® contacts in ELIO® high-density insert

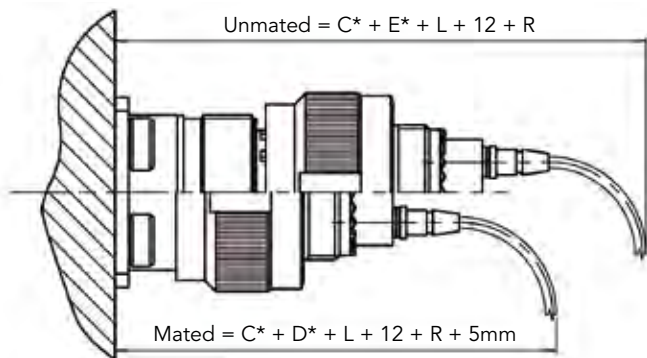

\* See previous page

Note: All dimensions are in millimeters (mm)



## Description

- Derived from MIL-DTL-38999 Series III
- True ruggedized RJ45 & USB A solution
- High vibration and shock resistant
- IP67
- Shielded
- Available in feed through, solder out and pig tail version
- No tools for cabling
- RoHS version
- Applications:
  - . Data transmission using standard interface
  - . Flight data transmissions

## Technical features

### Mechanical

- **Shell material:**
  - . Aluminum alloy
  - . Composite
- **Shell plating:**
  - . Olive drab cadmium
  - . Nickel
  - . Black zinc nickel
  - . Zinc cobalt
- **Insert:** Thermoplastic
- **Contacts:** Copper alloy
- **Contacts plating:** Gold
- **Endurance:**
  - . Per MIL-DTL-38999, 500 mating cycles
- **Vibration:** 10-500 Hz 20 g

### Electrical

- **RJ45:**
  - . 10 BaseT, 100 BaseTX and 1000 BaseT
  - . Cat 5e per TIA/EIA 568A/B
- **USB:**
  - . 10 BaseT and 100 BaseTX
  - . Cat 5e per TIA/EIA 568A/B

### Environmental

- **Sealing:** IP67 with protective cap
- **Temperature range:** -40°C to +85°C
- **Fluid resistance:**
  - . Per MIL-DTL-38999 with protective cap

## Connector part numbers

<b>Basic Series</b>	<b>8D</b>	<b>0</b>	<b>F</b>	<b>17</b>	<b>W</b>	<b>UA</b>	<b>S</b>	<b>N</b>
<b>Shell type:</b> 0: Square flange receptacle 7: Jam nut receptacle (aluminum only)								
<b>Designator:</b> F: Feedthrough S: Solder out C: Pig tail cable receptacle								
<b>Shell size:</b> 17: USB 19: RJ45								
<b>Plating:</b> W: Olive drab cadmium (aluminum) - 500 hours salt spray F: Nickel (aluminum) - 48 hours salt spray J: Olive drab cadmium (composite) - 500 hours salt spray M: Nickel (composite) - 500 hours salt spray Z: Black zinc nickel (aluminum) - 500 hours salt spray ZC: Zinc cobalt - 250 hours salt spray X: No finish (composite)								
<b>Insert:</b> UA: USB type A RJ: RJ45								
<b>Contact style:</b> S: Socket								
<b>Orientation:</b> N, A, B, C, D, E								
<b>Specification code:</b> Consult us for custom configuration (cable type, length, termination style)								

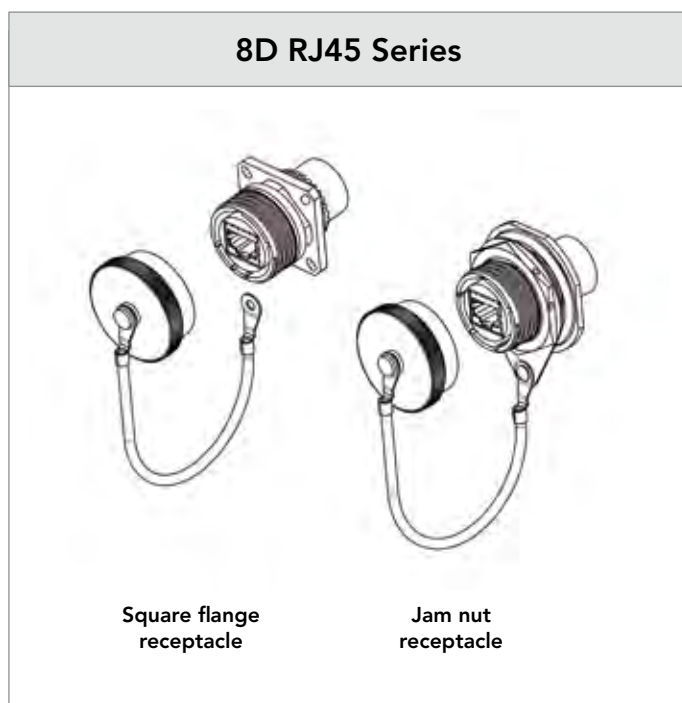

## Dimensions RJ45 interface

### RJ45 interface - receptacle feedthrough series

Square flange receptacle		
Material	A (max)	B (max)
Aluminum	20.55	2.50
Composite	20.78	3.65

Jam nut receptacle		
Material	A (max)	B (max)
Aluminum	21.34	3.20

### RJ45 interface - receptacle solder out series

Square flange receptacle		
Material	A (max)	B (max)
Aluminum	11.91	2.50
Composite	12.14	3.65

Jam nut receptacle		
Material	A (max)	B (max)
Aluminum	12.70	3.20

Note: All dimensions are in millimeters (mm)



### RJ45 interface - receptacle pigtail series

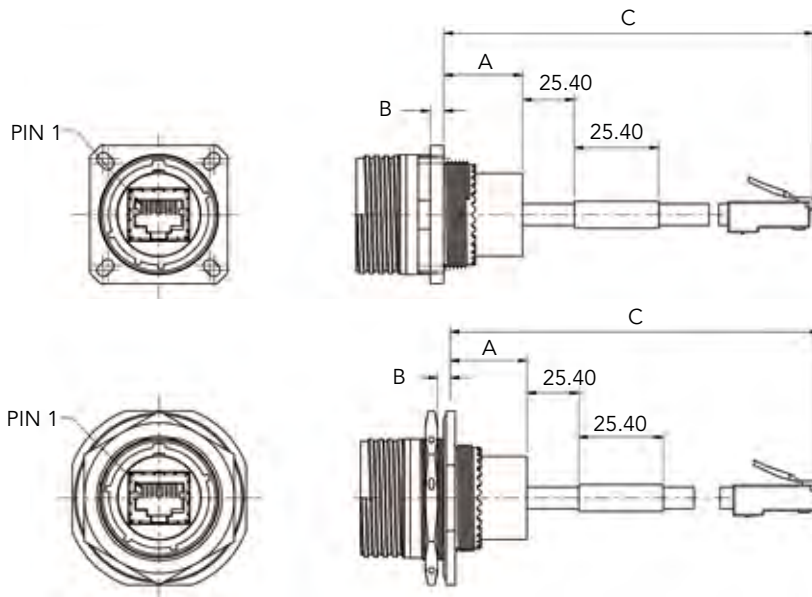

Square flange receptacle			
Material	A (max)	B (max)	C (max)
Aluminum	20.78	2.50	304.8 $\pm 25.4$
Composite	20.78	3.65	304.8 $\pm 25.4$

Jam nut receptacle			
Material	A (max)	B (max)	C (max)
Aluminum	21.34	3.20	304.8 $\pm 25.4$

### RJ45 interface - receptacle panel cut out

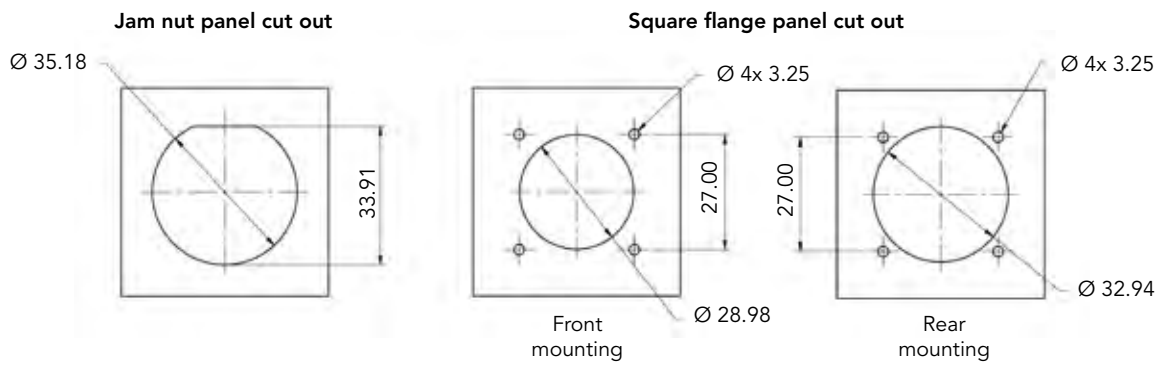

Note: All dimensions are in millimeters (mm)

## Dimensions USB interface

### USB interface - receptacle feedthrough series

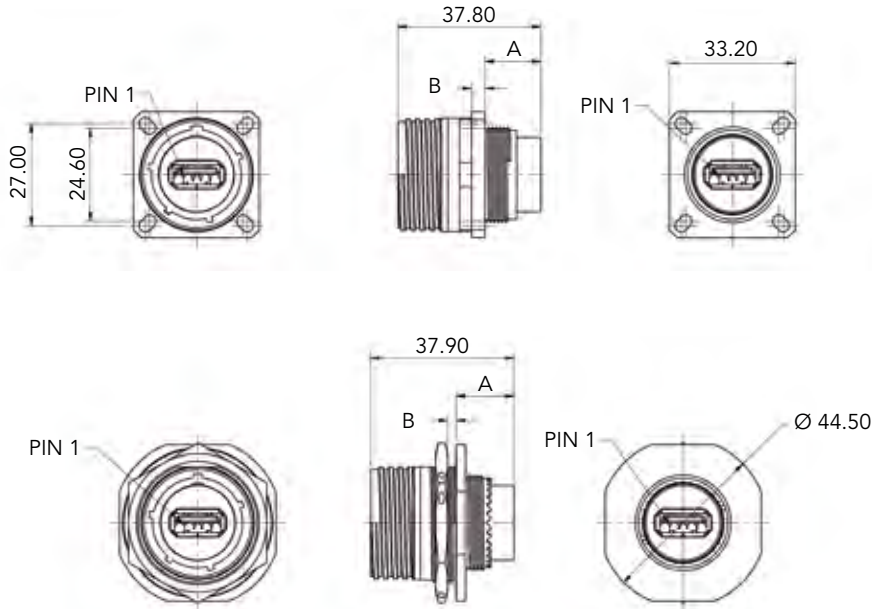

Square flange receptacle		
Material	A (max)	B (max)
Aluminum	14.45	2.50
Composite	14.68	3.65

Jam nut receptacle		
Material	A (max)	B (max)
Aluminum	15.24	3.20

### USB interface - receptacle solder out series

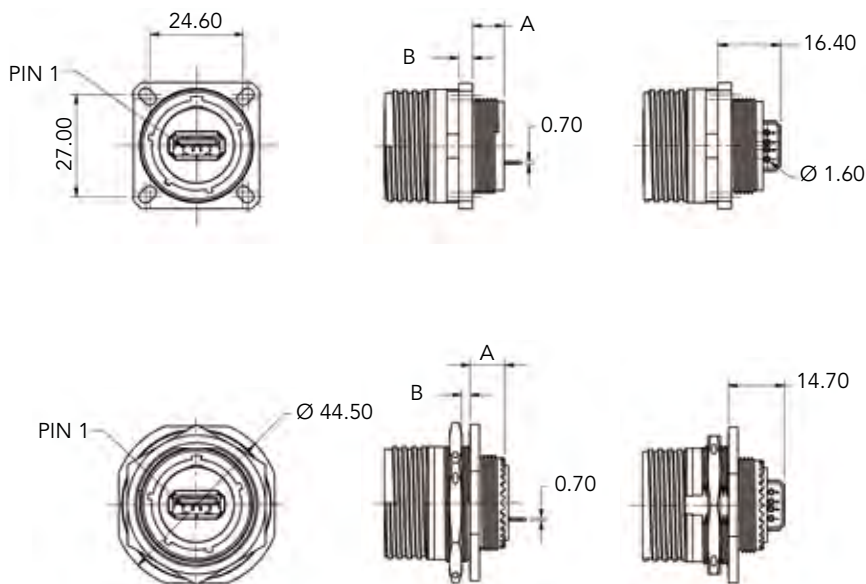

Square flange receptacle		
Material	A (max)	B (max)
Aluminum	8.10	2.50
Composite	8.33	3.65

Jam nut receptacle		
Material	A (max)	B (max)
Aluminum	11.94	3.20

Note: All dimensions are in millimeters (mm)

### USB interface - receptacle pigtail series

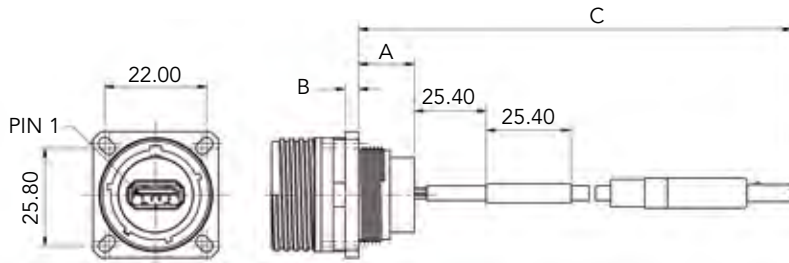

Square flange receptacle			
Material	A (max)	B (max)	C (max)
Aluminum	14.45	2.50	304.8 <sup>+25.4</sup>
Composite	14.68	3.65	304.8 <sup>+25.4</sup>

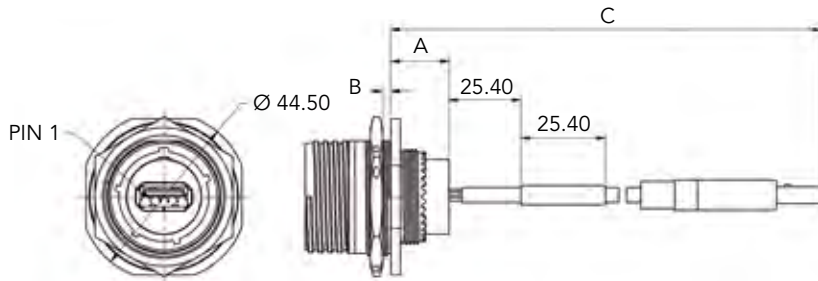

Jam nut receptacle			
Material	A (max)	B (max)	C (max)
Aluminum	15.24	3.20	304.8 <sup>+25.4</sup>

### USB interface - receptacle panel cut out

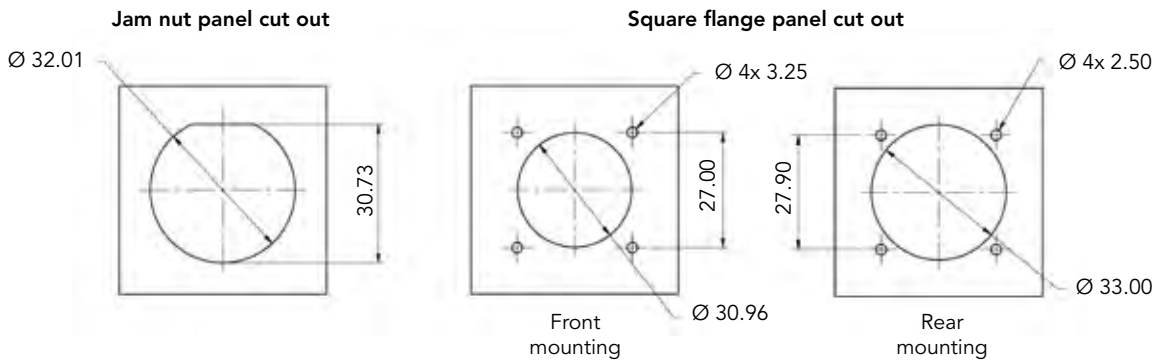

Note: All dimensions are in millimeters (mm)

# 8D SERIES

## 8D Series

# Range Extension

■ micro38999.....	142
■ ELIO® fiber optic hermetic .....	142
■ Rack & panel .....	143
■ 230V connector .....	143
■ 8D8/8D9 Series .....	144
■ 8DB bulkhead feedthrough.....	144
■ 8PS Series .....	145
■ 8TFD filter connector .....	145
■ 8D36 lanyard release .....	146

## Product range extension

### micr 38999

**A complete miniature range: threaded (8DA), break away (8BA) & bayonet (8LTA). Space saving with scoop proof connector for harsh applications.**

**A compact solution:**

- . Diameter up to 45% smaller than size 9 (D38999).
- . Up to 50% shorter.
- . Integrated backshell: Cost and space saving.

**A high density solution:**

- . With #26 contacts (according to 39029).
- . 5 layouts (size 3, 5 and 7 with #22 & #26).

**Excellent features:**

- . Designed for D38999 requirements.
- . IP67 sealing when mated.
- . Stainless steel shell (1500 matings) & aluminum shell (500 matings).

**RoHS and Cadmium free:**

- . Available in zinc nickel (RoHS) plating, as well as nickel and olive drab cadmium.



### ELIO® Fiber Optic Hermetic

**Hermetic receptacles or feedthrough based on 38999 shells, intermateable with 38999 Series III plug populated ELIO® contacts.**

**Truly hermetic:**

- . Leak rate:  $< 10^{-9}$  atm.cm<sup>3</sup>/s.
- . Temperature range: -55°C to 200°C.

**Wide range of layouts:**

- . From 1 to 24 fiber optic channels.

**Customs:**

- . Versatile technology that can be adapted to your needs.



## Product range extension

### Rack & Panel

**Sealed rack & panel for blind connection. A 100% scoop proof connector with quick connection in hard-to-reach areas.**

**Blind connection:**

- . Easy & fast connection without any coupling/uncoupling between a float-mounting unit & a fixed unit.

**Float-mounting unit - rack:**

- . Female crimp contacts.
- . Mounting on the cabinet side.
- . Angular orientation with a key.
- . Possibility to supply rear accessories.

**Misalignment catching:**

- . Longitudinal, axial and angular.



See «38999 Series I - Rack & Panel 8LT» product news on [www.souriau.com](http://www.souriau.com)

### 230V Connector

**The use of higher voltage to reduce cable weight has led to the development of double voltage connectors.**

**Robust design and materials:**

- . In high altitude un-pressurized areas, higher voltages increase electrical partial discharges: Risk of contact short circuits. Our 230V connector avoids this risk!

**No possible mismatch:**

- . Specific T and V clocking to avoid mating with a non 230V qualified counterpart.

**Flexible offering:**

- . Available in standard watertight and hermetic connectors with the same performance.
- . Available in composite and stainless steel shells.

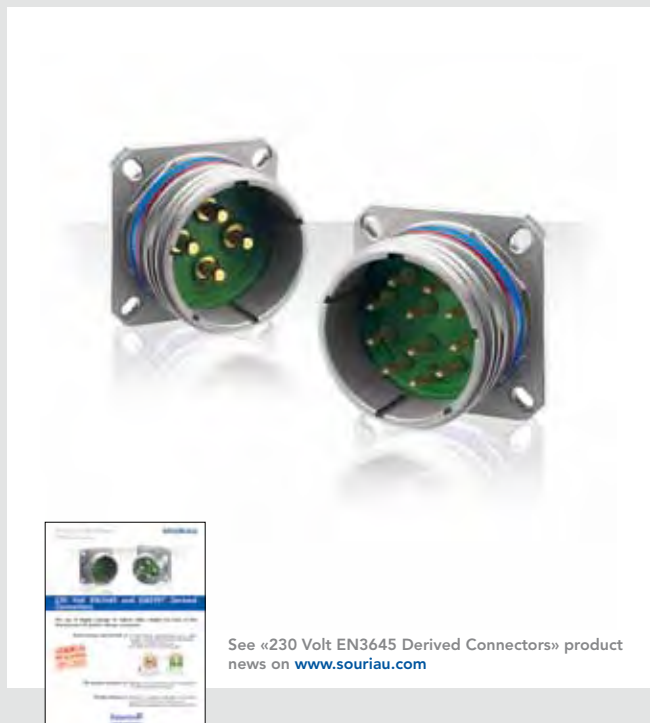

See «230 Volt EN3645 Derived Connectors» product news on [www.souriau.com](http://www.souriau.com)

## Product range extension

### 8D8/8D9 Series

**8D8: high vibration push-pull connector.**  
**8D9: lanyard release, high performance 38999 quick release.**

**A wide range with excellent performances:**

- . MIL-DTL-38999 layouts and contacts.
- . MIL-DTL-38999 Series electric performances.
- . Scoop proof.
- . Compatible with standard backshells 38999 Series III.
- . Very high performance coupling with ball locking concept, check of locking by free ring when mated.

**Easy to connect-disconnect:**

- . 8D8: ideal for restricted space mating.
- . 8D9: simple push to connect - pull to disconnect.

**High vibration performance:**

- . Up to 44g
- . 8D8: ideal for mil-aero and space applications.
- . 8D9: ideal for missiles, inter-stage separation, UAVs, space probes.



See «8D8/8D9 Series - 38999 Push pull/Quick release» catalog on [www.souriau.com](http://www.souriau.com)

### 8DB Bulkhead Feedthrough

**Double Receptacle mounted on panel allows cable plug connection on both sides of the bulkhead.**  
**Create a permanent sealed barrier on your panel suitable for pressurized or depressurized areas.**

**Easy integration:**

- . Standard 38999 mounting interface (square flange, jam nut).
- . Easy modular assembly and connection.
- . Time saving for maintenance.
- . The ideal interconnect solution for aircraft pressurized/non pressurized panels.

**Reinforced sealing:**

- . Feedthrough sealing even when unmated ( $10^{-6}$  atm.cm<sup>3</sup>/s).
- . Permanent sealing barrier on panel (O'rings).
- . Glass fused hermetic version available ( $<10^{-8}$  atm.cm<sup>3</sup>/s) for fuel tanks/space systems.

**A large platform available:**

- . All 38999 Series III layouts (signal and power contacts).



See «38999 Series III - Bulkhead Feedthrough» catalog on [www.souriau.com](http://www.souriau.com)



## Product range extension

### 8PS Series

**Sealed cable feedthrough. Allows a bundle of cables to cross through the bulkhead without any contact junctions.**

**All cables are individually sealed inside the feedthrough:**

- . For maximum MTBF by eliminating cable termination and contact junction.
- . When maximum continuity is required for copper cables.
- . To suppress contact attenuation with Fiber optic cables.

**Easy and safe installation.**

**Reinforced sealing.**



### 8TFD Filter Connector

**EMI-RFI filters and lightning protection in composite light-weight shell.**

**Space saving:**

- . Complete filter solution in standard shell.
- . No need for filter PCB inside equipment.
- . Smaller equipment envelope required.

**Excellent filter performance:**

- . Excellent performance, comparable to aluminum shell EMI-RFI filter connectors.

**Highly corrosion resistant:**

- . 2000 hours salt spray in either nickel or olive drab finish.

**Wide range of layouts available:**

- . SOURIAU EMI-RFI Filter 38999 Series III connectors are available in aluminum, marine bronze, and stainless steel shells.



## Product range extension

### 8D36 Lanyard Release

**Field repairable / MIL-STD-1760 umbilical.  
Self-alignment, blind connector mating & safe  
operational solution to weapon releases.**

**Safe quick disconnect at high speed:**

- . Robust unlocking system : 9.15m/s  $\pm$ 10%.

**Field repairable:**

- . Damaged coupling mechanism can be removed and fully replaced without need to disassemble the electric harness or cable backshell.

**High vibration performances:**

- . Random: 44 G RMS, Sine: 60G with angular separation up to 20° (maximum)





# Reliable People, Reliable Solutions



Your local contact



Our contribution to environmental protection:  
This catalog is printed on PEFC certified paper  
Advancement of sustainable wood cultivation. [www.pefc.org](http://www.pefc.org)

# SOURIAU

[www.souriau.com](http://www.souriau.com)  
[contactmilaero@souriau.com](mailto:contactmilaero@souriau.com)



## X-ON Electronics

Largest Supplier of Electrical and Electronic Components

*Click to view similar products for [Circular MIL Spec Connector](#) category:*

*Click to view products by [Sunbank](#) manufacturer:*

Other Similar products are found below :

[89075GULPR](#) [0025-264-3014](#) [58-570121-04S](#) [58-584653-12P](#) [0134-213-1007](#) [0134-213-1208](#) [0134-213-2209](#) [0025-258-000](#) [60-042022-02P](#) [60-042022-19P](#) [60-042022-23P](#) [012-0467-000](#) [602GB06EG24-61SN](#) [0134-201-1207](#) [0134-207-2009](#) [0134-213-1006](#) [6104-207-2302](#) [6104-208-1902](#) [6131-202-19149P](#) [6131-204-21149P](#) [6131-207-13149P](#) [6131-208-13149P](#) [6131-209-17149P](#) [6131-210-11149P](#) [6131-211-19149P](#) [6131-216-19149P](#) [6131-220-25149P](#) [6131-259-11149P](#) [6131-259-21149P](#) [6131-259-23149P](#) [6131-263-19149P](#) [6131-265-17149P](#) [6131-265-19149P](#) [6134-203-21149](#) [CS3100A18-1P-472](#) [CS3100A-36-77S](#) [CS3101A36-79S-SR](#) [CS3102A-10SL-53P](#) [CS3102A10SL-64S](#) [CS3102A-20-15S](#) [CS3102A-22-70S](#) [CS3102A-24-79S](#) [CS3102A24-AJS](#) [CS3102A-32-17P](#) [CS3102A32-25S](#) [CS3106A10SL3S004](#) [CS3106A-18-73S](#) [CS3106A-28-20P](#) [CS3106A-32-82S](#) [CS3106A36-79P-SR](#)