

SOURIAU

JMX SERIES



Plastic Push-Pull Coupling Mechanism

Connectors for Medical Applications



Contents

Overview

Typical applications	06
Features & Benefits	07
Reliable people, reliable solutions	08
Range overview	09
Layouts	09
General technical characteristics	10
Color codings	11

Connector

Overmolded cable assembly	14
2 contacts	16
3 contacts	20
4 contacts	24
5 contacts	28
6 contacts	32
7 contacts	36
8 contacts	40
10 contacts	44
12 contacts	48

Contacts

Description	54
Packaging	54
Solder contacts	55
Crimp contacts	56
Tooling	57

Technical Information

Receptacle assembly instructions	60
Plug assembly instructions	61
Which Standard to select ?	62
UL94 + UL1977	63
IEC 61984 & IP codes explained	66
What is NEMA rating ?	68
What is CE marking ?	68
Sterilization	69
Ethernet for the Layman	70

Appendices

Glossary of terms	74
Part number index	75

JMX SERIES

Overview

■ Typical applications	06
■ Features & Benefits	07
■ Reliable People, Reliable Solutions	08
■ Range overview	09
■ Layouts	09
■ General technical characteristics	10
■ Color codings	11

Typical applications



Physio & Medical Therapy



Patient Monitoring



Diagnostic Device & Imaging



Surgical & Dental Systems - Instrumentation



Laboratory Equipment



Features & Benefits

**EASY
AND
SAFE**

Reliable mating: Push-Pull Locking Mechanism

Only requires two fingers to mate/unmate securely with an audible and tactile indicator. Capable of mating over 2,000 times. Keyings and color identifications are available to avoid accidental system mating errors.

**PROTECT
YOUR
EQUIPMENT**

Waterproof: IP68 in Mated and/or Unmated Condition

JMX Series will protect your equipment from fluid ingress and liquid projection.

**STERILI-
ZATION**

Adapted for the Medical Market

Withstand to autoclave steam sterilization with pre-vacuum and gravity displacement process per IEC 60601. 200 autoclave cycles at 134°C (273°F).

**AESTHETIC
EQUIPMENT**

Designed for an Aesthetic Equipment Design

An attractive, appealing and ergonomic connector to fit with all medical equipment designs.

**MAKE
LIFE
EASIER**

UL/IEC Compliant

In accordance with UL 1977 and IEC 61984: a compliance making your equipment qualification easier.

We have thought of everything...



Rubber sealing gland



Compound



Waterproof – IP68

- A rubber gland certifying the sealing between the cable and the plug
- Compound on solder receptacles ensuring the IP68 in unmated condition



A Full Solution Offering (see page 14)

- IP68 and Overmolded Cable Assembly solutions available in standard or custom designs
- Withstands autoclave process



A Reinforced Traceability

- A date code (Year - Week) available on the plug and receptacle to ensure full traceability
- Not visible once installed



Ergonomic / Aesthetic design

- An instinctive feeling design with your fingers
- Keying and color identification to help avoid accidental mating errors
- Attractive and appealing design to fit with all medical equipment

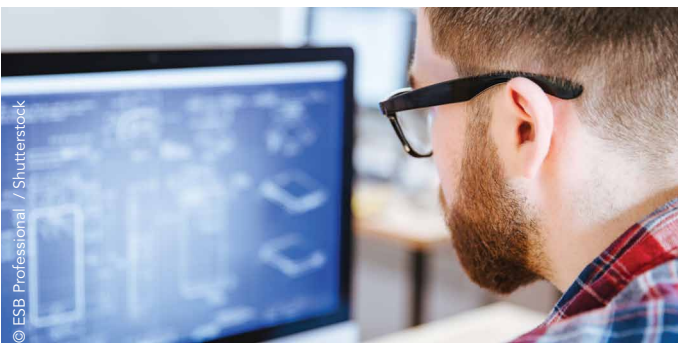

Flexibility & Availability

- Worldwide distribution network ensuring full availability and logistical support
- Customized interconnect solutions
- A dedicated team available for technical support, training and engineering collaboration
- An integrated and certified laboratory to perform tests and qualifications

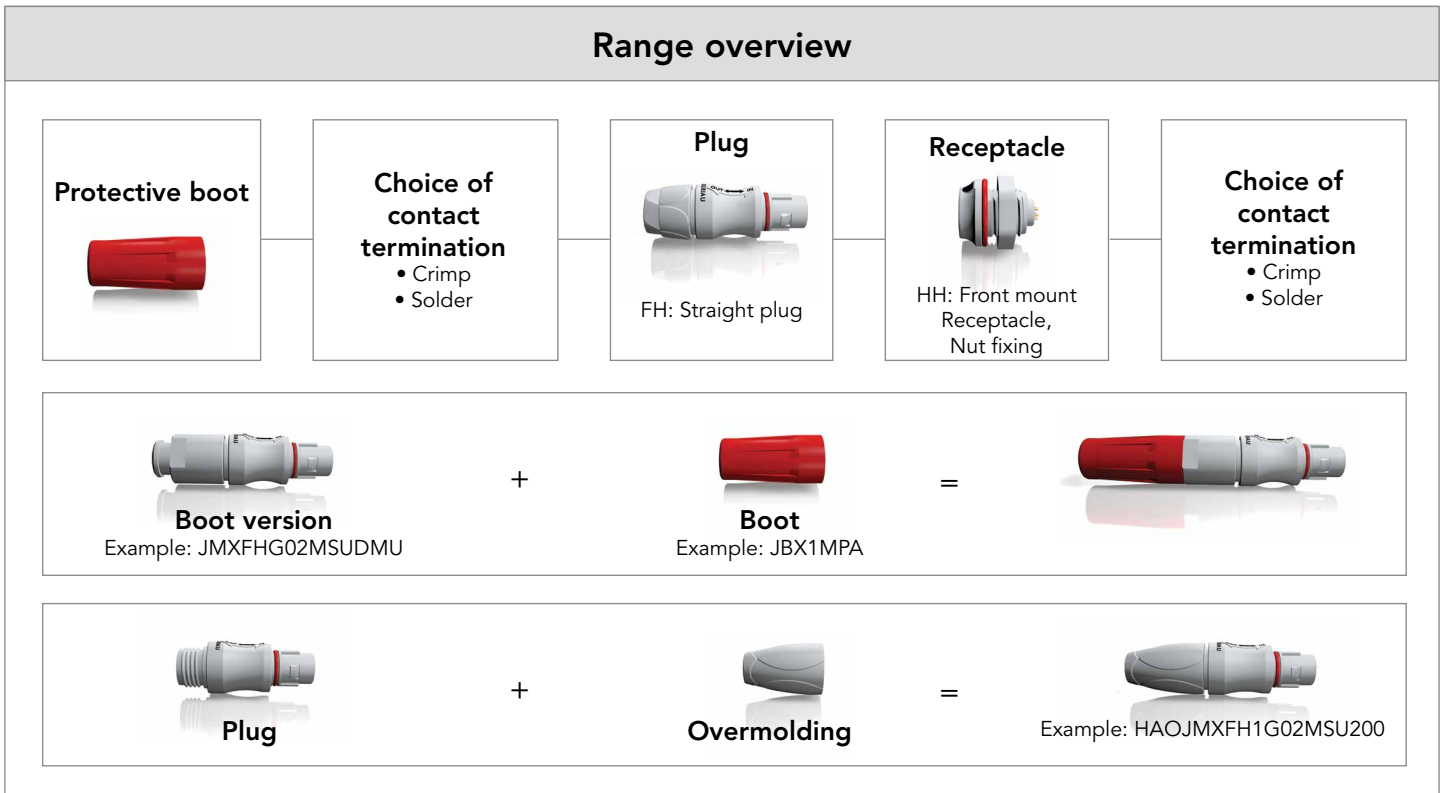

Layouts

Voltages shown below are Test Voltages measured according to the IEC 60512-2 test 4a. Test voltage corresponds to 75% of the mean dielectric withstanding voltage. Operating voltage could be calculated following the method: $\frac{\text{Test Voltage}}{3}$









Please refer to the connector section for the UL and IEC voltage values.

Contacts $\varnothing 0.5\text{mm} / \varnothing 0.019''$
Solder Wire: AWG 28 and smaller
Crimp Wire: Not available

Contacts $\varnothing 0.7\text{mm} / \varnothing 0.027''$
Solder Wire: AWG 22 and smaller
Crimp Wire: AWG 22 - 24 - 26

Contacts $\varnothing 0.9\text{mm} / \varnothing 0.035''$
Solder Wire: AWG 22 and smaller
Crimp Wire: AWG 20 - 22 - 24

Contacts $\varnothing 1.3\text{mm} / \varnothing 0.051''$
Solder Wire: AWG 20 and smaller
Crimp Wire: AWG 18 - 20 - 22



Shell size	Contact $\varnothing 0.5\text{ mm}$	Contact $\varnothing 0.7\text{ mm}$	Contact $\varnothing 0.9\text{ mm}$	Contact $\varnothing 1.3\text{ mm}$
1	10 contacts 2.5A 900V AC/CD mini: 0.58 mm  Page 44	6 contacts 6A 1,000V AC/CD mini: 0.75 mm  Page 32	4 contacts 8A 1,100V AC/CD mini: 1.00 mm  Page 24	2 contacts 10A 1,200V AC/CD mini: 1.20 mm  Page 16
	12 contacts 2.5A 900V AC/CD mini: 0.59 mm  Page 48	7 contacts 5A 1,000V AC/CD mini: 0.75 mm  Page 36	5 contacts 7A 1,100V AC/CD mini: 0.80 mm  Page 28	3 contacts 9A 1,100V AC/CD mini: 1.00 mm  Page 20
		8 contacts 5A 900V AC/CD mini: 0.54 mm  Page 40		

Note: AC/CD mini means minimum "Air Clearance" or "Creepage Distance".

General technical characteristics



Materials

- **Shell:** PEI
- **Insert:** PEEK
- **Collet:** PEI
- **Cable seal:** Silicon rubber
- **Clip:** Beryllium copper
- **Contacts:** Cupro-Nickel
- **Contacts plating:** Gold
- **RoHS compliant** 
- **REACH compliant** 
- **Biocompatibility:**
Shell material biocompatible to USP Class VI / ISO 10993

Environmental

- **Operating temperature:**
 - Receptacle: -20°C +100°C / -4°F +212°F
 - Plug: -40°C +125°C / -40°F +257°F
 - Short term (autoclaving): Resistance up to +134°C / 273.2°F
- **Flammability rating:**
UL94 V-0
- **Steam sterilization:**
Withstand to autoclave steam sterilization pre-vacuum & gravity displacement process: 200 cycles per EN13060

Sealing:

	Mated conditions (Plug + receptacle)	Unmated conditions		
		Plug	Receptacle with solder contacts	Receptacle with crimp contacts
IP50	-	✓	-	✓
IP68*	✓	-	✓	-

*IP68 (1 bar during 1 week) per IEC60529

- IP68 versions are identified with the symbol "  " into the connector section.

Fluid resistance:

- Isopropyl alcohol
- Ethanol
- Sodium Hypochlorite
- Korsolex Extra
- Gigasept FF
- Incidur
- Sekusept Plus
- Sani Cloth active

Please consult us for other fluid resistance request

Mechanical

- **Durability:**
> 2,000 cycles per IEC 60512-5 test 9a
- **Mechanical strength impact:**
Dropping height 750 mm /29.527" per IEC 60512-7-2 test 7b
- **Color coding:**
9 color codings. Please refer to the page 11 and the connector section

Discrimination/Keying Method:

Please refer to the page 11

Acceptable cable diameter:

3.5 mm to 7.5 mm, 0.137" to 0.295"

Traction on the cable:

In mated condition	
Traction by pulling on the cable of the plug without using the uncoupling system	
Average value 100N	
Method IEC 60512-8 Test 15f	

In unmated condition	
Traction by pulling on the cable of the plug	
Max 150 N Depends on the cable	
Method IEC 60512-9 Test 17c	

Electrical

- **Compliant to UL 1977 and IEC 61984**

- Also see page 09

Color coding



In addition to the keyings, SOURIAU offers 9 colors codings on receptacles and plugs to help the user to identify the correct connector. JMX color identification remains visible in mated conditions.

Standard connector is delivered without color identification. To order a receptacle or a plug with a color, replace the final "U" by the color code from the table below.

Example: JMXHH1G02MSUDSU (no color identification) => JMXHH1G02MSUDSV (Green color identification).

Color	Blue	Purple	Grey	Yellow	Brown	Black	Red	Green	Orange
Color									
Coding	A	P	G	J	M	N	R	V	O

Discrimination / Keying methods

In applications where similar connectors are used next to each other, mismatching can cause disturbances, system failures or even danger to operating personnel.

To eliminate mismatching, JMX connectors are offered with discrimination keys to avoid interconnection system errors.

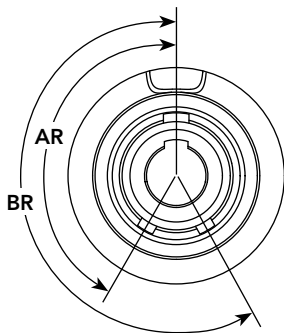

Viewed from front face receptacle

Position	AR	BR
A	45°	180°
B	135°	225°
C	45°	225°
D	135°	315°
E	180°	315°
G	165°	195°

G is the standard keying. Other keyings can be ordered by replacing the G character by the needed keying. JMXHH1G03MSUDSU (G keying) => JMXHH1A03MSUDSU (A keying)

JMX SERIES

JMX Series

Connector

■ Overmolded cable assembly	14
■ 2 contacts	
JMX1-02: 10A 1,200V	16
■ 3 contacts	
JMX1-03: 9A 1,100V	20
■ 4 contacts	
JMX1-04: 8A 1,100V	24
■ 5 contacts	
JMX1-05: 7A 1,100V	28
■ 6 contacts	
JMX1-06: 6A 1,000V	32
■ 7 contacts	
JMX1-07: 5A 1,000V	36
■ 8 contacts	
JMX1-08: 5A 900V	40
■ 10 contacts	
JMX1-10: 2.5A 900V	44
■ 12 contacts	
JMX1-12: 2.5A 900V	48

Overmolded cable assembly

SOURIAU has provided connectors for various applications for more than 90 years and has been used in the most extreme environments. Conscious about the difficulty in finding a quick and reliable harness manufacturer, we developed our own in-house overmolded cable assembly production. It allows customers to reduce the number of suppliers and to take advantage of the “best in class” quality of the SOURIAU group. Overmolding is a process that further enhances the sealing properties and helps to minimize stress on the cable termination to the connector. In addition, the wires are encapsulated inside the molding which creates a barrier preventing liquid/moisture from entering the equipment through the connector or cable jacket if breached.



General technical characteristics

Materials

- **Connector**
 - **Shell:** PEI
 - **Insert:** PEEK
 - **Contacts:** see layout pages
- **Cable:**
 - **Insulation conductor type:** FEP
 - **600V**
 - **RoHS compliant** 

Environmental

- **Operating temperature:**
 - From -20°C to +80°C / -4 °F to 176 °F
 - Short term (autoclaving): Resistance up to +134°C / 273.2°F
- **Sealing:**
 - IP65 in unmated condition
 - IP68 in mated condition
- **Steam sterilization:**
Withstand to autoclave steam sterilization pre-vacuum & gravity displacement process: 200 cycles per EN13060

Mechanical

- **Durability:**
> 2,000 cycles

JMX overmolded cable assembly

Overmolding description

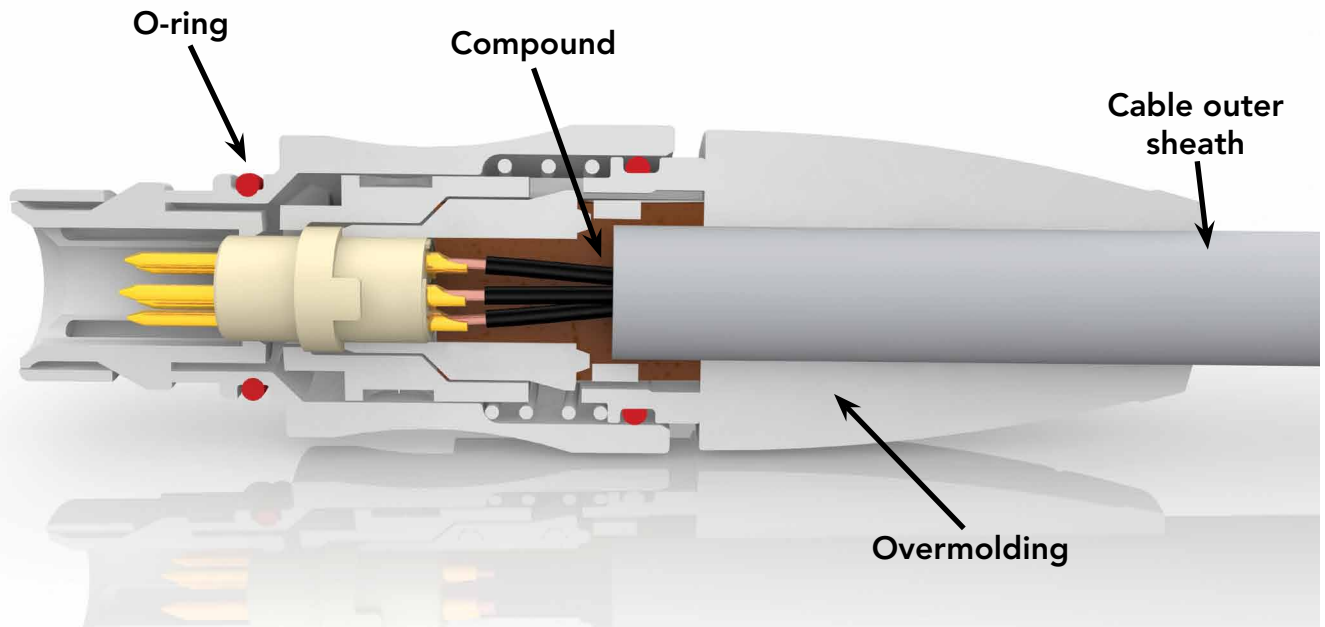

Connector

Connector with cable gland backshell

If cable jacket is breached...

GOOD

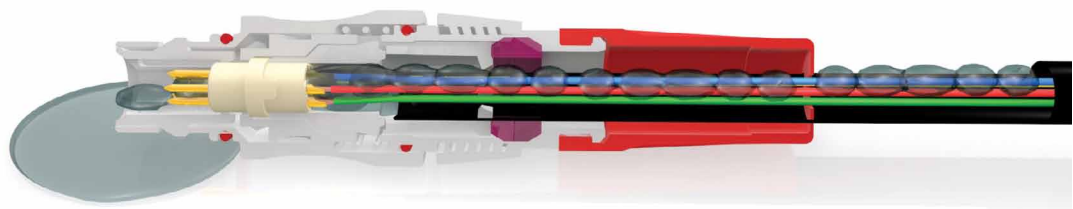

...water ingress unhampered, leading to damage.

Overmolded connector

If cable jacket is breached...

BEST

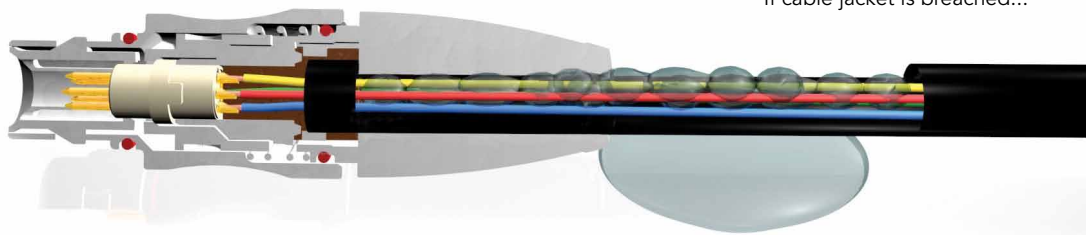

...the compound will block the liquid and prevent ingress.

JMX1-02 (2 x Ø 1.3 mm / 2 x Ø 0.051")

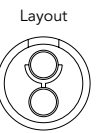

Connector part number (Products without color coding)

Contact type	Connector type	Description	Part number	
			Male insert	Female insert
Solder contacts see page 19	Receptacle	Front mount, nut fixing (HH)	JMXHH1G02MSUDSU	JMXHH1G02FSUDSU
	Plug	Straight plug (FH) *	JMXFH1G02MSUDSU	JMXFH1G02FSUDSU
Crimp contacts see page 19	Receptacle	Front mount, nut fixing (HH)	JMXHH1G02MCUDSU	JMXHH1G02FCUDSU
	Plug	Straight plug (FH) *	JMXFH1G02MCUDSU	JMXFH1G02FCUDSU

* In order to get the back nut version for protective boot, replace the "S" by a "M". Example: JMX Straight Plug, size 1, 2 solder contacts, male insert = JMXFH1G02MSUDMU. The protective boot need to be ordered separately. See page accessories.

: Sealed in Unmated Condition

Overmolded cable assembly part number

Layout	Description	Connector and overmold type		Length*		
		Connector	Overmold type	1m / 39.370"	2m / 78.740"	3m / 118.110"
1-02	Plug overmolded cable assembly	Male plug	Straight	HAOJMXFH1G02MCU100	HAOJMXFH1G02MCU200	HAOJMXFH1G02MCU300
		Female plug	Straight	HAOJMXFH1G02FCU100	HAOJMXFH1G02FCU200	HAOJMXFH1G02FCU300

* : Other lengths or specific design requirement please consult us

JMX1-02 (2 x Ø 1.3 mm / 2 x Ø 0.051")

Dimensions (For mated connector lengths see page 19)

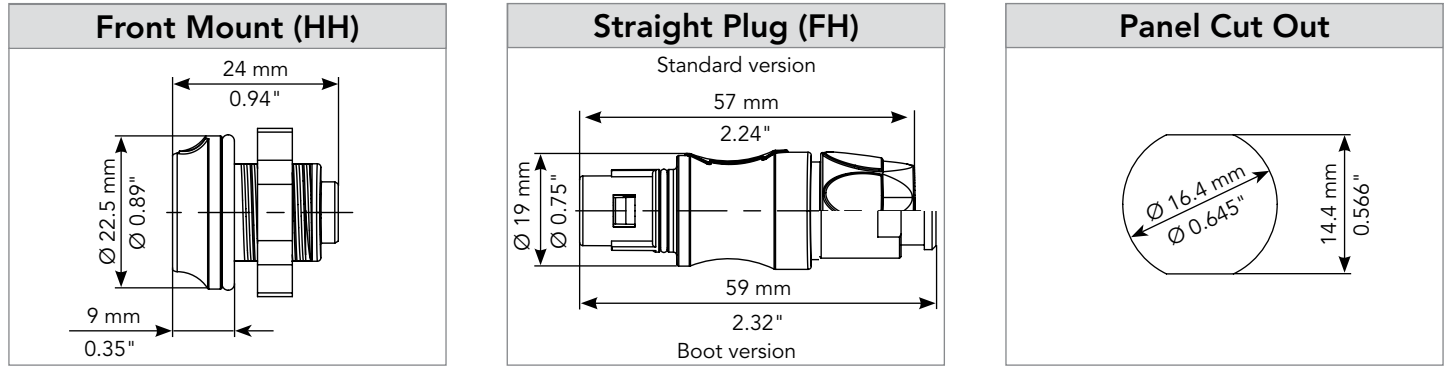

Connector color coding

Color	Coding	Part number ⁽¹⁾		
		Receptacle	Plug	Overmolded
None	U	JMXHH1G02..UDSU	JMXFH1G02..UDSU	HA0JMXFH1G02..U***
Blue	A	JMXHH1G02..UDSA	JMXFH1G02..UDSA	HA0JMXFH1G02..A***
Purple	P	JMXHH1G02..UDSP	JMXFH1G02..UDSP	HA0JMXFH1G02..P***
Grey	G	JMXHH1G02..UDSG	JMXFH1G02..UDSG	HA0JMXFH1G02..G***
Yellow	J	JMXHH1G02..UDSJ	JMXFH1G02..UDSJ	HA0JMXFH1G02..J***
Brown	M	JMXHH1G02..UDSM	JMXFH1G02..UDSM	HA0JMXFH1G02..M***
Black	N	JMXHH1G02..UDSN	JMXFH1G02..UDSN	HA0JMXFH1G02..N***
Red	R	JMXHH1G02..UDSR	JMXFH1G02..UDSR	HA0JMXFH1G02..R***
Green	V	JMXHH1G02..UDSV	JMXFH1G02..UDSV	HA0JMXFH1G02..V***
Orange	O	JMXHH1G02..UDSO	JMXFH1G02..UDSO	HA0JMXFH1G02..O***

1: Standard HH receptacle is delivered without color identification. To order a receptacle or a plug with a color, replace the final "U" by the color code from the table above.
 ". . .": first "." = gender, second "." = termination.
 "***": harness length = 100 (1m), 200 (2m) or 300 (3m).
 Example : JMXHH1G02MSUDSU (no color identification) => JMXHH1G02MSUDSV (Green color identification).

JMX1-02 (2 x Ø 1.3 mm / 2 x Ø 0.051")

Accessories

Receptacle dust cap



Part number
JMXBR1

Plug dust cap



Part number
JMXBF1

Plug protective boot

Available only for FH, with back nut protective boot 



Part number	Color
JBX1MPA	Blue
JBX1MPB	White
JBX1MPG	Grey
JBX1MPJ	Yellow
JBX1MPM	Brown
JBX1MPN	Black
JBX1MPR	Red
JBX1MPV	Green
JBX1MPO	Orange

The overall length is 25 mm/0.98" longer with the protective boot.
 Note: The protective boot is not a sealing element.

Tooling for crimp contacts

Crimp tooling



Part number
MIL-22520/7-01

Locator



Part number	
Male	Female
JBX10UTLP13	JBX10UTLS13

Extraction tool

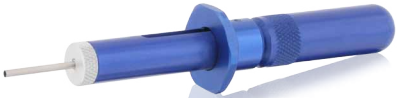

Part number
JBXOUTDC13



JMX1-02 (2 x Ø 1.3 mm / 2 x Ø 0.051")

Contacts

Ø 1.3 mm / Ø 0.051 "	Contact type	Plating	Contact locking type	AWG
Solder	Machined	0.5 µm gold over 3 to 5 µm Ni	Removable on plugs	20 and smaller
Crimp	Machined	0.5 µm gold over 3 to 5 µm Ni	Removable	18 - 20 - 22

For more information see pages 55 to 56

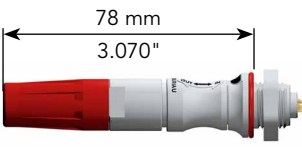
Mated connector length

FH Plug + Receptacle		
 <p>51 mm 2.007"</p> <p>with HH</p>	 <p>78 mm 3.070"</p> <p>with Boot and HH</p>	 <p>61 mm 2.401"</p> <p>with Overmolding and HH</p>

Connector

IEC / UL characteristics	
<p>IEC 10A 840 Vdc 1.5 kV 2</p>	<p>UL 10A 300V UL94 V-0</p>

JMX1-03 (3 x Ø 1.3 mm / 3 x Ø 0.051")

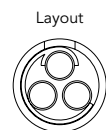

Connector part number (Products without color coding)

Contact type	Connector type	Description	Part number	
			Male insert	Female insert
Solder contacts see page 23	Receptacle	Front mount, nut fixing (HH) ☁	JMXHH1G03MSUDSU	JMXHH1G03FSUDSU
	Plug	Straight plug (FH) *	JMXFH1G03MSUDSU	JMXFH1G03FSUDSU
Crimp contacts see page 23	Receptacle	Front mount, nut fixing (HH)	JMXHH1G03MCUDSU	JMXHH1G03FCUDSU
	Plug	Straight plug (FH) *	JMXFH1G03MCUDSU	JMXFH1G03FCUDSU

* In order to get the back nut version for protective boot, replace the "S" by a "M". Example: JMX Straight Plug, size 1, 3 solder contacts, male insert = JMXFH1G03MSUDMU. The protective boot need to be ordered separately. See page accessories.

☁ : Sealed in Unmated Condition

Overmolded cable assembly part number

Layout	Description	Connector and overmold type		Length*		
		Connector	Overmold type	1m / 39.370"	2m / 78.740"	3m / 118.110"
1-02	Plug overmolded cable assembly	Male plug	Straight	HAOJMXFH1G03MCU100	HAOJMXFH1G03MCU200	HAOJMXFH1G03MCU300
		Female plug	Straight	HAOJMXFH1G03FCU100	HAOJMXFH1G03FCU200	HAOJMXFH1G03FCU300

* : Other lengths or specific design requirement please consult us

JMX1-03 (3 x Ø 1.3 mm / 3 x Ø 0.051")

Dimensions (For mated connector lengths see page 23)

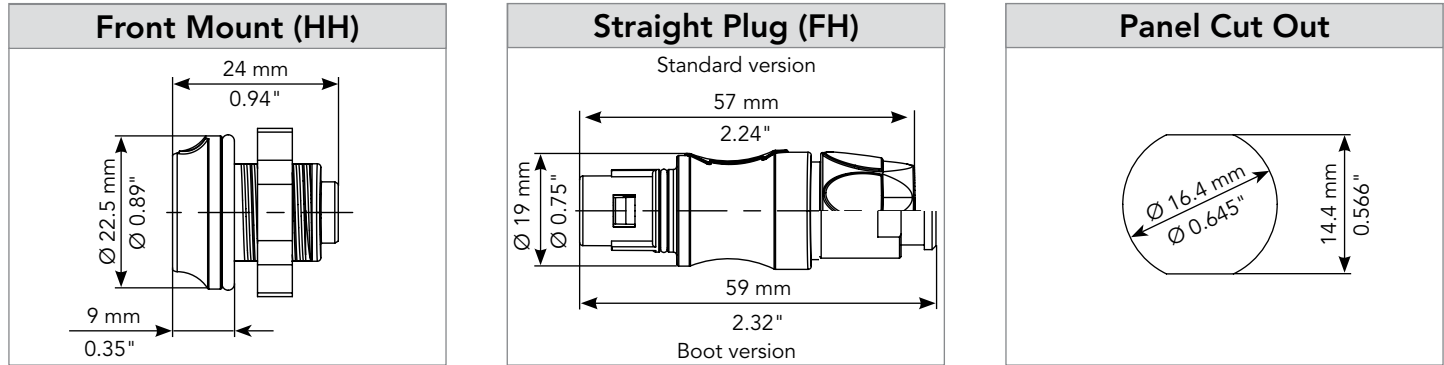

Connector color coding

Color	Coding	Part number ⁽¹⁾		
		Receptacle	Plug	Overmolded
None	U	JMXHH1G03..UDSU	JMXFH1G03..UDSU	HA0JMXFH1G03..U***
Blue	A	JMXHH1G03..UDSA	JMXFH1G03..UDSA	HA0JMXFH1G03..A***
Purple	P	JMXHH1G03..UDSP	JMXFH1G03..UDSP	HA0JMXFH1G03..P***
Grey	G	JMXHH1G03..UDSG	JMXFH1G03..UDSG	HA0JMXFH1G03..G***
Yellow	J	JMXHH1G03..UDSJ	JMXFH1G03..UDSJ	HA0JMXFH1G03..J***
Brown	M	JMXHH1G03..UDSM	JMXFH1G03..UDSM	HA0JMXFH1G03..M***
Black	N	JMXHH1G03..UDSN	JMXFH1G03..UDSN	HA0JMXFH1G03..N***
Red	R	JMXHH1G03..UDSR	JMXFH1G03..UDSR	HA0JMXFH1G03..R***
Green	V	JMXHH1G03..UDSV	JMXFH1G03..UDSV	HA0JMXFH1G03..V***
Orange	O	JMXHH1G03..UDSO	JMXFH1G03..UDSO	HA0JMXFH1G03..O***

1: Standard HH receptacle is delivered without color identification. To order a receptacle or a plug with a color, replace the final "U" by the color code from the table above.

".": first "." = gender, second "." = termination.

"***": harness length = 100 (1m), 200 (2m) or 300 (3m).

Example : JMXHH1G03MSUDSU (no color identification) => JMXHH1G03MSUDSV (Green color identification).

JMX1-03 (3 x Ø 1.3 mm / 3 x Ø 0.051")

Accessories

Receptacle dust cap



Part number
JMXBR1

Plug dust cap



Part number
JMXBF1

Plug protective boot

Available only for FH, with back nut protective boot 



Part number	Color
JBX1MPA	Blue
JBX1MPB	White
JBX1MPG	Grey
JBX1MPJ	Yellow
JBX1MPM	Brown
JBX1MPN	Black
JBX1MPR	Red
JBX1MPV	Green
JBX1MPO	Orange

The overall length is 25 mm/0.98" longer with the protective boot.
Note: The protective boot is not a sealing element.

Tooling for crimp contacts

Crimp tooling



Part number
MIL-22520/7-01

Locator



Part number	
Male	Female
JBX10UTLP13	JBX10UTLS13

Extraction tool

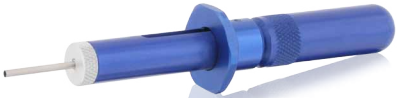

Part number
JBXOUTDC13



JMX1-03 (3 x Ø 1.3 mm / 3 x Ø 0.051")

Contacts

Ø 1.3 mm / Ø 0.051 "	Contact type	Plating	Contact locking type	AWG
Solder	Machined	0.5 µm gold over 3 to 5 µm Ni	Removable on plugs	20 and smaller
Crimp	Machined	0.5 µm gold over 3 to 5 µm Ni	Removable	18 - 20 - 22

For more information see pages 55 to 56

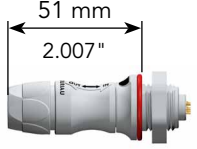
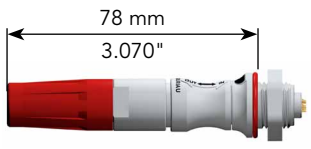
Mated connector length

FH Plug + Receptacle		
 <p>51 mm 2.007"</p> <p>with HH</p>	 <p>78 mm 3.070"</p> <p>with Boot and HH</p>	 <p>61 mm 2.401"</p> <p>with Overmolding and HH</p>

Connector

IEC / UL characteristics	
<p>IEC 9A 840 Vdc 1.5 kV 2</p>	<p>UL 9A 230V UL94 V-0</p>

JMX1-04 (4 x Ø 0.9 mm / 4 x Ø 0.035")

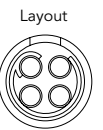

Connector part number (Products without color coding)

Contact type	Connector type	Description	Part number	
			Male insert	Female insert
Solder contacts see page 27	Receptacle	Front mount, nut fixing (HH) ☁	JMXHH1G04MSUDSU	JMXHH1G04FSUDSU
	Plug	Straight plug (FH) *	JMXFH1G04MSUDSU	JMXFH1G04FSUDSU
Crimp contacts see page 27	Receptacle	Front mount, nut fixing (HH)	JMXHH1G04MCUDSU	JMXHH1G04FCUDSU
	Plug	Straight plug (FH) *	JMXFH1G04MCUDSU	JMXFH1G04FCUDSU

* In order to get the back nut version for protective boot, replace the "S" by a "M". Example: JMX Straight Plug, size 1, 4 solder contacts, male insert = JMXFH1G04MSUDMU. The protective boot need to be ordered separately. See page accessories.

☁ : Sealed in Unmated Condition

Overmolded cable assembly part number

Layout	Description	Connector and overmold type		Length*		
		Connector	Overmold type	1m / 39.370"	2m / 78.740"	3m / 118.110"
1-02	Plug overmolded cable assembly	Male plug	Straight	HAOJMXFH1G04MCU100	HAOJMXFH1G04MCU200	HAOJMXFH1G04MCU300
		Female plug	Straight	HAOJMXFH1G04FCU100	HAOJMXFH1G04FCU200	HAOJMXFH1G04FCU300

* : Other lengths or specific design requirement please consult us

JMX1-04 (4 x Ø 0.9 mm / 4 x Ø 0.035")

Dimensions (For mated connector lengths see page 27)

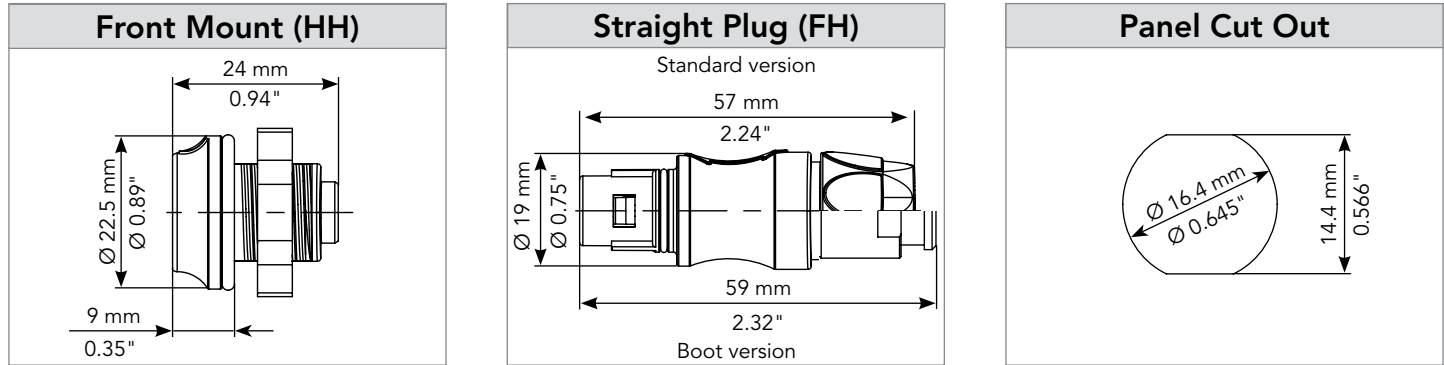

Connector color coding

Color	Coding	Part number ⁽¹⁾		
		Receptacle	Plug	Overmolded
None	U	JMXHH1G04 . .UDSU	JMXFH1G04 . .UDSU	HA0JMXFH1G04 . .U***
Blue	A	JMXHH1G04 . .UDSA	JMXFH1G04 . .UDSA	HA0JMXFH1G04 . .A***
Purple	P	JMXHH1G04 . .UDSP	JMXFH1G04 . .UDSP	HA0JMXFH1G04 . .P***
Grey	G	JMXHH1G04 . .UDSG	JMXFH1G04 . .UDSG	HA0JMXFH1G04 . .G***
Yellow	J	JMXHH1G04 . .UDSJ	JMXFH1G04 . .UDSJ	HA0JMXFH1G04 . .J***
Brown	M	JMXHH1G04 . .UDSM	JMXFH1G04 . .UDSM	HA0JMXFH1G04 . .M***
Black	N	JMXHH1G04 . .UDSN	JMXFH1G04 . .UDSN	HA0JMXFH1G04 . .N***
Red	R	JMXHH1G04 . .UDSR	JMXFH1G04 . .UDSR	HA0JMXFH1G04 . .R***
Green	V	JMXHH1G04 . .UDSV	JMXFH1G04 . .UDSV	HA0JMXFH1G04 . .V***
Orange	O	JMXHH1G04 . .UDSO	JMXFH1G04 . .UDSO	HA0JMXFH1G04 . .O***

1: Standard HH receptacle is delivered without color identification. To order a receptacle or a plug with a color, replace the final "U" by the color code from the table above.
 ". .": first "." = gender, second "." = termination.
 "***": harness length = 100 (1m), 200 (2m) or 300 (3m).
 Example : JMXHH1G04MSUDSU (no color identification) => JMXHH1G04MSUDSV (Green color identification).

JMX1-04 (4 x Ø 0.9 mm / 4 x Ø 0.035")

Accessories

Receptacle dust cap



Part number
JMXBR1

Plug dust cap



Part number
JMXBF1

Plug protective boot

Available only for FH, with back nut protective boot 



Part number	Color
JBX1MPA	Blue
JBX1MPB	White
JBX1MPG	Grey
JBX1MPJ	Yellow
JBX1MPM	Brown
JBX1MPN	Black
JBX1MPR	Red
JBX1MPV	Green
JBX1MPO	Orange

The overall length is 25 mm/0.98" longer with the protective boot.
 Note: The protective boot is not a sealing element.

Tooling for crimp contacts

Crimp tooling



Part number
MIL-22520/7-01

Locator



Part number	
Male	Female
JBX10UTLP09	JBX10UTLS09

Extraction tool



Part number
JBXOUTDC09



JMX1-04 (4 x Ø 0.9 mm / 4 x Ø 0.035")

Contacts

Ø 0.9 mm / Ø 0.035"	Contact type	Plating	Contact locking type	AWG
Solder	Machined	0.5 µm gold over 3 to 5 µm Ni	Removable on plugs	22 and smaller
Crimp	Machined	0.5 µm gold over 3 to 5 µm Ni	Removable	20 - 22 - 24

For more information see pages 55 to 56

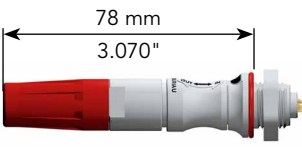
Mated connector length

FH Plug + Receptacle		
 <p>51 mm 2.007"</p> <p>with HH</p>	 <p>78 mm 3.070"</p> <p>with Boot and HH</p>	 <p>61 mm 2.401"</p> <p>with Overmolding and HH</p>

IEC / UL characteristics	
<p>IEC 8A 840 Vdc 1.5 kV 2</p>	<p>UL 8A 230V UL94 V-0</p>

JMX1-05 (5 x Ø 0.9 mm / 5 x Ø 0.035")

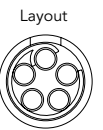

Connector part number (Products without color coding)

Contact type	Connector type	Description	Part number	
			Male insert	Female insert
Solder contacts see page 31	Receptacle	Front mount, nut fixing (HH) ☁	JMXHH1G05MSUDSU	JMXHH1G05FSUDSU
	Plug	Straight plug (FH) *	JMXFH1G05MSUDSU	JMXFH1G05FSUDSU
Crimp contacts see page 31	Receptacle	Front mount, nut fixing (HH)	JMXHH1G05MCUDSU	JMXHH1G05FCUDSU
	Plug	Straight plug (FH) *	JMXFH1G05MCUDSU	JMXFH1G05FCUDSU

* In order to get the back nut version for protective boot, replace the "S" by a "M". Example: JMX Straight Plug, size 1, 5 solder contacts, male insert = JMXFH1G05MSUDMU. The protective boot need to be ordered separately. See page accessories.

☁ : Sealed in Unmated Condition

Overmolded cable assembly part number

Layout	Description	Connector and overmold type		Length*		
		Connector	Overmold type	1m / 39.370"	2m / 78.740"	3m / 118.110"
1-02	Plug overmolded cable assembly	Male plug	Straight	HAOJMXFH1G05MCU100	HAOJMXFH1G05MCU200	HAOJMXFH1G05MCU300
		Female plug	Straight	HAOJMXFH1G05FCU100	HAOJMXFH1G05FCU200	HAOJMXFH1G05FCU300

* : Other lengths or specific design requirement please consult us

JMX1-05 (5 x Ø 0.9 mm / 5 x Ø 0.035")

Dimensions (For mated connector lengths see page 31)

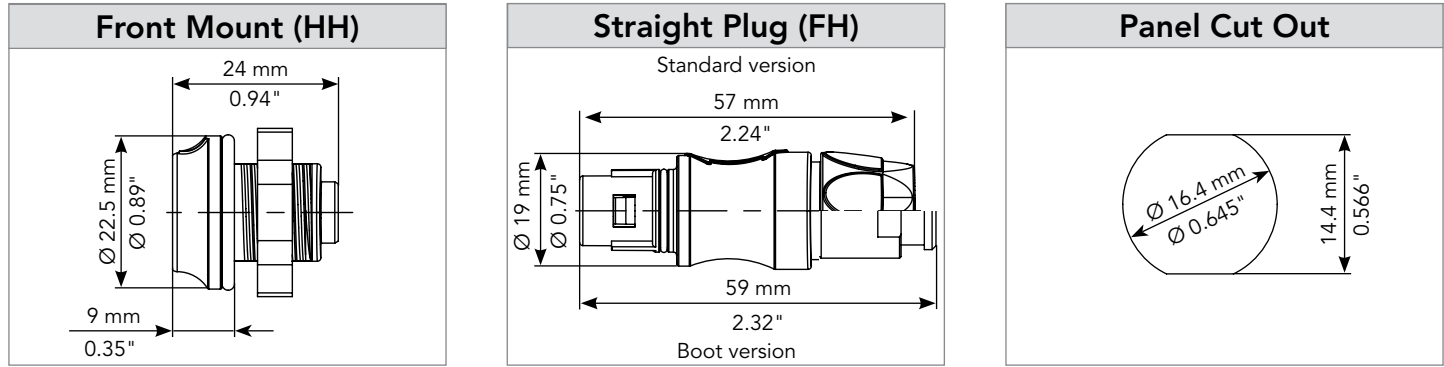

Connector color coding

Color	Coding	Part number ⁽¹⁾		
		Receptacle	Plug	Overmolded
None	U	JMXHH1G05 . .UDSU	JMXFH1G05 . .UDSU	HA0JMXFH1G05 . .U***
Blue	A	JMXHH1G05 . .UDSA	JMXFH1G05 . .UDSA	HA0JMXFH1G05 . .A***
Purple	P	JMXHH1G05 . .UDSP	JMXFH1G05 . .UDSP	HA0JMXFH1G05 . .P***
Grey	G	JMXHH1G05 . .UDSG	JMXFH1G05 . .UDSG	HA0JMXFH1G05 . .G***
Yellow	J	JMXHH1G05 . .UDSJ	JMXFH1G05 . .UDSJ	HA0JMXFH1G05 . .J***
Brown	M	JMXHH1G05 . .UDSM	JMXFH1G05 . .UDSM	HA0JMXFH1G05 . .M***
Black	N	JMXHH1G05 . .UDSN	JMXFH1G05 . .UDSN	HA0JMXFH1G05 . .N***
Red	R	JMXHH1G05 . .UDSR	JMXFH1G05 . .UDSR	HA0JMXFH1G05 . .R***
Green	V	JMXHH1G05 . .UDSV	JMXFH1G05 . .UDSV	HA0JMXFH1G05 . .V***
Orange	O	JMXHH1G05 . .UDSO	JMXFH1G05 . .UDSO	HA0JMXFH1G05 . .O***

1: Standard HH receptacle is delivered without color identification. To order a receptacle or a plug with a color, replace the final "U" by the color code from the table above.
 ". .": first "." = gender, second "." = termination.
 "***": harness length = 100 (1m), 200 (2m) or 300 (3m).
 Example : JMXHH1G05MSUDSU (no color identification) => JMXHH1G05MSUDSV (Green color identification).

JMX1-05 (5 x Ø 0.9 mm / 5 x Ø 0.035")

Accessories

Receptacle dust cap



Part number
JMXBR1

Plug dust cap



Part number
JMXBF1

Plug protective boot

Available only for FH, with back nut protective boot 



Part number	Color
JBX1MPA	Blue
JBX1MPB	White
JBX1MPG	Grey
JBX1MPJ	Yellow
JBX1MPM	Brown
JBX1MPN	Black
JBX1MPR	Red
JBX1MPV	Green
JBX1MPO	Orange

The overall length is 25 mm/0.98" longer with the protective boot.
Note: The protective boot is not a sealing element.

Tooling for crimp contacts

Crimp tooling



Part number
MIL-22520/7-01

Locator



Part number	
Male	Female
JBX10UTLP09	JBX10UTLS09

Extraction tool



Part number
JBX0UTDC09



JMX1-05 (5 x Ø 0.9 mm / 5 x Ø 0.035")

Contacts

Ø 0.7 mm / Ø 0.027"	Contact type	Plating	Contact locking type	AWG
Solder	Machined	0.5 µm gold over 3 to 5 µm Ni	Removable on plugs	22 and smaller
Crimp	Machined	0.5 µm gold over 3 to 5 µm Ni	Removable	20 - 22 - 24

For more information see pages 55 to 56

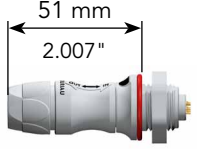
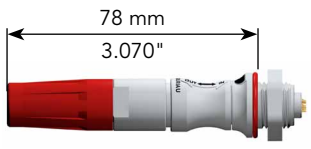
Mated connector length

FH Plug + Receptacle		
 <p>51 mm 2.007"</p> <p>with HH</p>	 <p>78 mm 3.070"</p> <p>with Boot and HH</p>	 <p>61 mm 2.401"</p> <p>with Overmolding and HH</p>

IEC / UL characteristics	
<p>IEC 7A 840 Vdc 1.5 kV 2</p>	<p>UL 7A 230V UL94 V-0</p>

JMX1-06 (6 x Ø 0.7 mm / 6 x Ø 0.027")

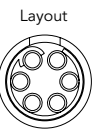

Connector part number (Products without color coding)

Contact type	Connector type	Description	Part number	
			Male insert	Female insert
Solder contacts see page 35	Receptacle	Front mount, nut fixing (HH) ☁	JMXHH1G06MSUDSU	JMXHH1G06FSUDSU
	Plug	Straight plug (FH) *	JMXFH1G06MSUDSU	JMXFH1G06FSUDSU
Crimp contacts see page 35	Receptacle	Front mount, nut fixing (HH)	JMXHH1G06MCUDSU	JMXHH1G06FCUDSU
	Plug	Straight plug (FH) *	JMXFH1G06MCUDSU	JMXFH1G06FCUDSU

* In order to get the back nut version for protective boot, replace the "S" by a "M". Example: JMX Straight Plug, size 1, 6 solder contacts, male insert = JMXFH1G06MSUDMU. The protective boot need to be ordered separately. See page accessories.

☁ : Sealed in Unmated Condition

Overmolded cable assembly part number

Layout	Description	Connector and overmold type		Length*		
		Connector	Overmold type	1m / 39.370"	2m / 78.740"	3m / 118.110"
1-02	Plug overmolded cable assembly	Male plug	Straight	HAOJMXFH1G06MCU100	HAOJMXFH1G06MCU200	HAOJMXFH1G06MCU300
		Female plug	Straight	HAOJMXFH1G06FCU100	HAOJMXFH1G06FCU200	HAOJMXFH1G06FCU300

* : Other lengths or specific design requirement please consult us

JMX1-06 (6 x Ø 0.7 mm / 6 x Ø 0.027")

Dimensions (For mated connector lengths see page 35)

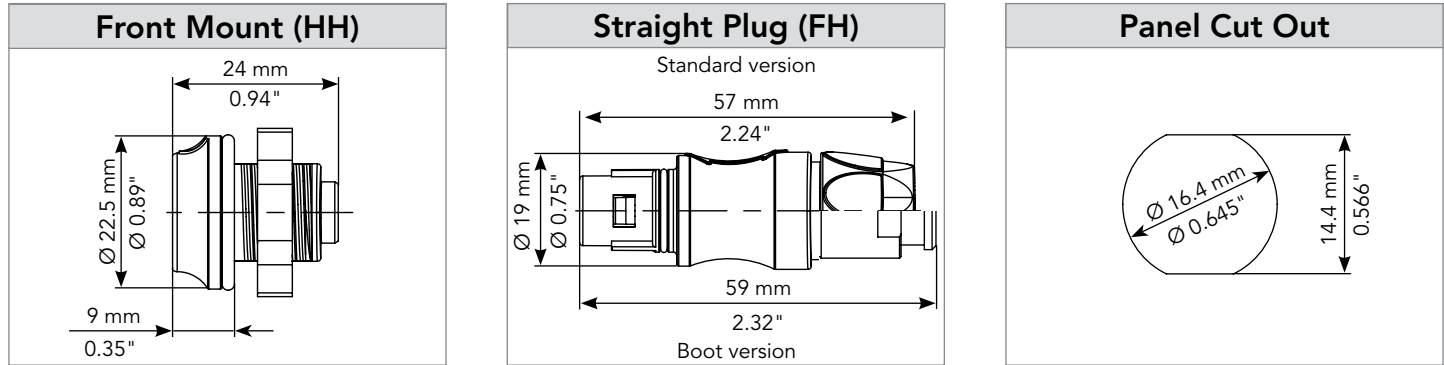

Connector color coding

Color	Coding	Part number ⁽¹⁾		
		Receptacle	Plug	Overmolded
None	U	JMXHH1G06 . .UDSU	JMXFH1G06 . .UDSU	HA0JMXFH1G06 . .U***
Blue	A	JMXHH1G06 . .UDSA	JMXFH1G06 . .UDSA	HA0JMXFH1G06 . .A***
Purple	P	JMXHH1G06 . .UDSP	JMXFH1G06 . .UDSP	HA0JMXFH1G06 . .P***
Grey	G	JMXHH1G06 . .UDSG	JMXFH1G06 . .UDSG	HA0JMXFH1G06 . .G***
Yellow	J	JMXHH1G06 . .UDSJ	JMXFH1G06 . .UDSJ	HA0JMXFH1G06 . .J***
Brown	M	JMXHH1G06 . .UDSM	JMXFH1G06 . .UDSM	HA0JMXFH1G06 . .M***
Black	N	JMXHH1G06 . .UDSN	JMXFH1G06 . .UDSN	HA0JMXFH1G06 . .N***
Red	R	JMXHH1G06 . .UDSR	JMXFH1G06 . .UDSR	HA0JMXFH1G06 . .R***
Green	V	JMXHH1G06 . .UDSV	JMXFH1G06 . .UDSV	HA0JMXFH1G06 . .V***
Orange	O	JMXHH1G06 . .UDSO	JMXFH1G06 . .UDSO	HA0JMXFH1G06 . .O***

1: Standard HH receptacle is delivered without color identification. To order a receptacle or a plug with a color, replace the final "U" by the color code from the table above.
 ". .": first "." = gender, second "." = termination.
 "***": harness length = 100 (1m), 200 (2m) or 300 (3m).
 Example : JMXHH1G06MSUDSU (no color identification) => JMXHH1G06MSUDSV (Green color identification).

JMX1-06 (6 x Ø 0.7 mm / 6 x Ø 0.027")

Accessories

Receptacle dust cap



Part number
JMXBR1

Plug dust cap



Part number
JMXBF1

Plug protective boot

Available only for FH, with back nut protective boot 



Part number	Color
JBX1MPA	Blue
JBX1MPB	White
JBX1MPG	Grey
JBX1MPJ	Yellow
JBX1MPM	Brown
JBX1MPN	Black
JBX1MPR	Red
JBX1MPV	Green
JBX1MPO	Orange

The overall length is 25 mm/0.98" longer with the protective boot.
Note: The protective boot is not a sealing element.

Tooling for crimp contacts

Crimp tooling



Part number
MIL-22520/7-01

Locator



Part number	
Male	Female
JBX10UTLP07	JBX10UTLS07

Extraction tool



Part number
JBXOUTDC07



JMX1-06 (6 x Ø 0.7 mm / 6 x Ø 0.027")

Contacts

Ø 0.7 mm / Ø 0.027"	Contact type	Plating	Contact locking type	AWG
Solder	Machined	0.5 µm gold over 3 to 5 µm Ni	Fixed	22 and smaller
Crimp	Machined	0.5 µm gold over 3 to 5 µm Ni	Removable	22 - 24 - 26

For more information see pages 55 to 56

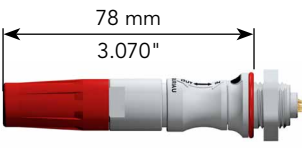
Mated connector length

FH Plug + Receptacle		
 <p>51 mm 2.007"</p> <p>with HH</p>	 <p>78 mm 3.070"</p> <p>with Boot and HH</p>	 <p>61 mm 2.401"</p> <p>with Overmolding and HH</p>

IEC / UL characteristics	
<p>IEC 6A 840 Vdc 1.5 kV 2</p>	<p>UL 6A 160V UL94 V-0</p>

JMX1-07 (7 x Ø 0.7 mm / 7 x Ø 0.027")

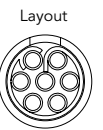

Connector part number (Products without color coding)

Contact type	Connector type	Description	Part number	
			Male insert	Female insert
Solder contacts see page 39	Receptacle	Front mount, nut fixing (HH) ☁	JMXHH1G07MSUDSU	JMXHH1G07FSUDSU
	Plug	Straight plug (FH) *	JMXFH1G07MSUDSU	JMXFH1G07FSUDSU
Crimp contacts see page 39	Receptacle	Front mount, nut fixing (HH)	JMXHH1G07MCUDSU	JMXHH1G07FCUDSU
	Plug	Straight plug (FH) *	JMXFH1G07MCUDSU	JMXFH1G07FCUDSU

* In order to get the back nut version for protective boot, replace the "S" by a "M". Example: JMX Straight Plug, size 1, 7 solder contacts, male insert = JMXFH1G07MSUDMU. The protective boot need to be ordered separately. See page accessories.

☁ : Sealed in Unmated Condition

Overmolded cable assembly part number

Layout	Description	Connector and overmold type		Length*		
		Connector	Overmold type	1m / 39.370"	2m / 78.740"	3m / 118.110"
1-02	Plug overmolded cable assembly	Male plug	Straight	HAOJMXFH1G07MCU100	HAOJMXFH1G07MCU200	HAOJMXFH1G07MCU300
		Female plug	Straight	HAOJMXFH1G07FCU100	HAOJMXFH1G07FCU200	HAOJMXFH1G07FCU300

* : Other lengths or specific design requirement please consult us

JMX1-07 (7 x Ø 0.7 mm / 7 x Ø 0.027")

Dimensions (For mated connector lengths see page 39)

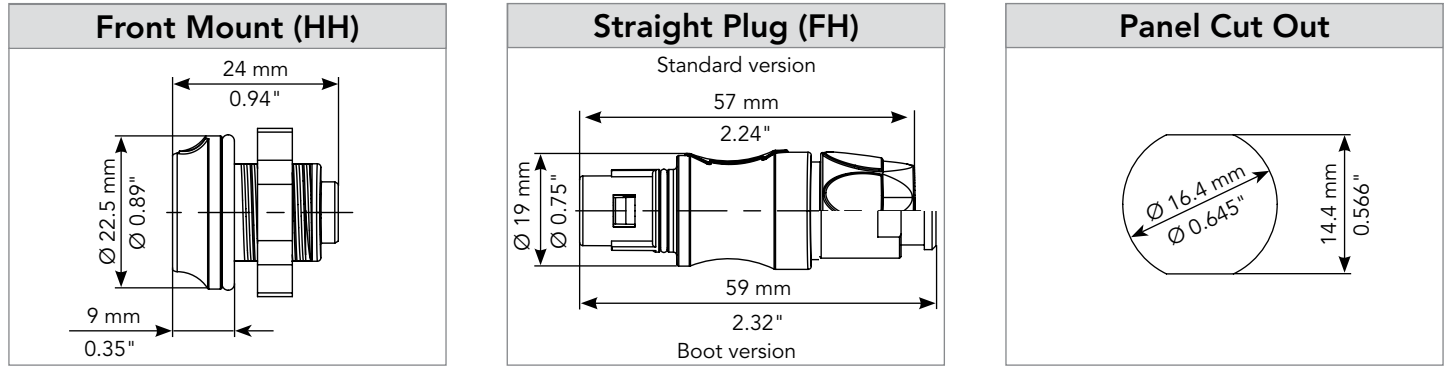

Connector color coding

Color	Coding	Part number ⁽¹⁾		
		Receptacle	Plug	Overmolded
None	U	JMXHH1G07..UDSU	JMXFH1G07..UDSU	HA0JMXFH1G07..U***
Blue	A	JMXHH1G07..UDSA	JMXFH1G07..UDSA	HA0JMXFH1G07..A***
Purple	P	JMXHH1G07..UDSP	JMXFH1G07..UDSP	HA0JMXFH1G07..P***
Grey	G	JMXHH1G07..UDSG	JMXFH1G07..UDSG	HA0JMXFH1G07..G***
Yellow	J	JMXHH1G07..UDSJ	JMXFH1G07..UDSJ	HA0JMXFH1G07..J***
Brown	M	JMXHH1G07..UDSM	JMXFH1G07..UDSM	HA0JMXFH1G07..M***
Black	N	JMXHH1G07..UDSN	JMXFH1G07..UDSN	HA0JMXFH1G07..N***
Red	R	JMXHH1G07..UDSR	JMXFH1G07..UDSR	HA0JMXFH1G07..R***
Green	V	JMXHH1G07..UDSV	JMXFH1G07..UDSV	HA0JMXFH1G07..V***
Orange	O	JMXHH1G07..UDSO	JMXFH1G07..UDSO	HA0JMXFH1G07..O***

1: Standard HH receptacle is delivered without color identification. To order a receptacle or a plug with a color, replace the final "U" by the color code from the table above.
 ". . .": first "." = gender, second "." = termination.
 "***": harness length = 100 (1m), 200 (2m) or 300 (3m).
 Example : JMXHH1G07MSUDSU (no color identification) => JMXHH1G07MSUDSV (Green color identification).

JMX1-07 (7 x Ø 0.7 mm / 7 x Ø 0.027")

Accessories

Receptacle dust cap



Part number
JMXBR1

Plug dust cap



Part number
JMXBF1

Plug protective boot

Available only for FH, with back nut protective boot 



Part number	Color
JBX1MPA	Blue
JBX1MPB	White
JBX1MPG	Grey
JBX1MPJ	Yellow
JBX1MPM	Brown
JBX1MPN	Black
JBX1MPR	Red
JBX1MPV	Green
JBX1MPO	Orange

The overall length is 25 mm/0.98" longer with the protective boot.
Note: The protective boot is not a sealing element.

Tooling for crimp contacts

Crimp tooling



Part number
MIL-22520/7-01

Locator



Part number	
Male	Female
JBX10UTLP07	JBX10UTLS07

Extraction tool



Part number
JBX0UTDC07



JMX1-07 (7 x Ø 0.7 mm / 7 x Ø 0.027")

Contacts

Ø 0.7 mm / Ø 0.027"	Contact type	Plating	Contact locking type	AWG
Solder	Machined	0.5 µm gold over 3 to 5 µm Ni	Fixed	22 and smaller
Crimp	Machined	0.5 µm gold over 3 to 5 µm Ni	Removable	22 - 24 - 26

For more information see pages 55 to 56

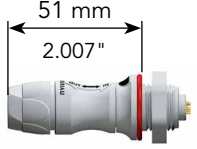
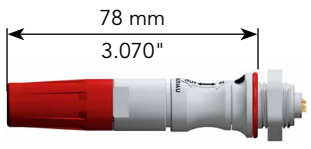
Mated connector length

FH Plug + Receptacle		
 <p>51 mm 2.007"</p> <p>with HH</p>	 <p>78 mm 3.070"</p> <p>with Boot and HH</p>	 <p>61 mm 2.401"</p> <p>with Overmolding and HH</p>

Connector

IEC / UL characteristics	
<p>IEC 5A 840 Vdc 1.5 kV 2</p>	<p>UL 5A 160V UL94 V-0</p>

JMX1-08 (8 x Ø 0.7 mm / 8 x Ø 0.027")

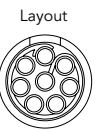

Connector part number (Products without color coding)

Contact type	Connector type	Description	Part number	
			Male insert	Female insert
Solder contacts see page 43	Receptacle	Front mount, nut fixing (HH) ☁	JMXHH1G08MSUDSU	JMXHH1G08FSUDSU
	Plug	Straight plug (FH) *	JMXFH1G08MSUDSU	JMXFH1G08FSUDSU
Crimp contacts see page 43	Receptacle	Front mount, nut fixing (HH)	JMXHH1G08MCUDSU	JMXHH1G08FCUDSU
	Plug	Straight plug (FH) *	JMXFH1G08MCUDSU	JMXFH1G08FCUDSU

* In order to get the back nut version for protective boot, replace the "S" by a "M". Example: JMX Straight Plug, size 1, 8 solder contacts, male insert = JMXFH1G08MSUDMU. The protective boot need to be ordered separately. See page accessories.

☁ : Sealed in Unmated Condition

Overmolded cable assembly part number

Layout	Description	Connector and overmold type		Length*		
		Connector	Overmold type	1m / 39.370"	2m / 78.740"	3m / 118.110"
1-02	Plug overmolded cable assembly	Male plug	Straight	HAOJMXFH1G08MCU100	HAOJMXFH1G08MCU200	HAOJMXFH1G08MCU300
		Female plug	Straight	HAOJMXFH1G08FCU100	HAOJMXFH1G08FCU200	HAOJMXFH1G08FCU300

* : Other lengths or specific design requirement please consult us

JMX1-08 (8 x Ø 0.7 mm / 8 x Ø 0.027")

Dimensions (For mated connector lengths see page 43)

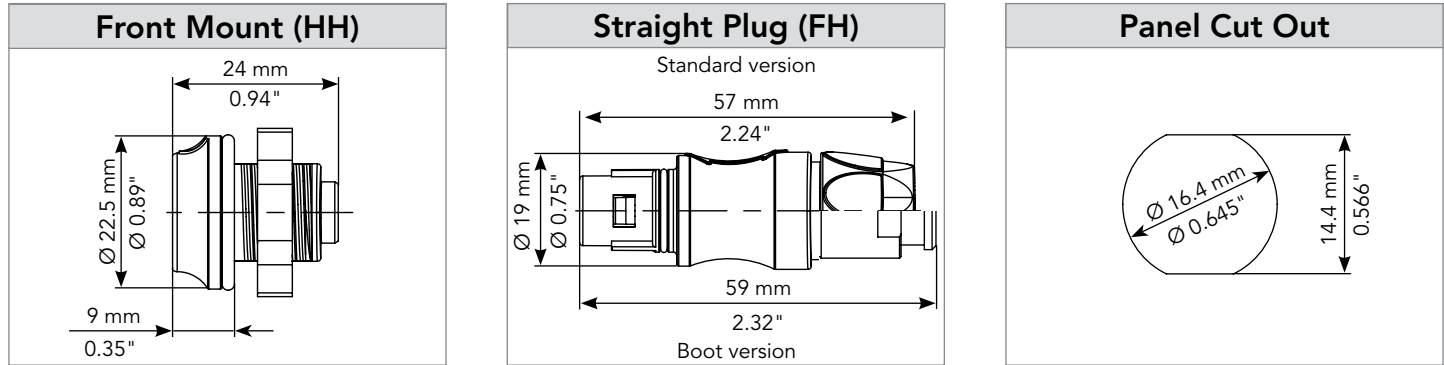

Connector color coding

Color	Coding	Part number ⁽¹⁾		
		Receptacle	Plug	Overmolded
None	U	JMXHH1G08 . .UDSU	JMXFH1G08 . .UDSU	HA0JMXFH1G08 . .U***
Blue	A	JMXHH1G08 . .UDSA	JMXFH1G08 . .UDSA	HA0JMXFH1G08 . .A***
Purple	P	JMXHH1G08 . .UDSP	JMXFH1G08 . .UDSP	HA0JMXFH1G08 . .P***
Grey	G	JMXHH1G08 . .UDSG	JMXFH1G08 . .UDSG	HA0JMXFH1G08 . .G***
Yellow	J	JMXHH1G08 . .UDSJ	JMXFH1G08 . .UDSJ	HA0JMXFH1G08 . .J***
Brown	M	JMXHH1G08 . .UDSM	JMXFH1G08 . .UDSM	HA0JMXFH1G08 . .M***
Black	N	JMXHH1G08 . .UDSN	JMXFH1G08 . .UDSN	HA0JMXFH1G08 . .N***
Red	R	JMXHH1G08 . .UDSR	JMXFH1G08 . .UDSR	HA0JMXFH1G08 . .R***
Green	V	JMXHH1G08 . .UDSV	JMXFH1G08 . .UDSV	HA0JMXFH1G08 . .V***
Orange	O	JMXHH1G08 . .UDSO	JMXFH1G08 . .UDSO	HA0JMXFH1G08 . .O***

1: Standard HH receptacle is delivered without color identification. To order a receptacle or a plug with a color, replace the final "U" by the color code from the table above.
 ". .": first "." = gender, second "." = termination.
 "***": harness length = 100 (1m), 200 (2m) or 300 (3m).
 Example : JMXHH1G08MSUDSU (no color identification) => JMXHH1G08MSUDSV (Green color identification).

JMX1-08 (8 x Ø 0.7 mm / 8 x Ø 0.027")

Accessories

Receptacle dust cap



Part number
JMXBR1

Plug dust cap



Part number
JMXBF1

Plug protective boot

Available only for FH, with back nut protective boot 



Part number	Color
JBX1MPA	Blue
JBX1MPB	White
JBX1MPG	Grey
JBX1MPJ	Yellow
JBX1MPM	Brown
JBX1MPN	Black
JBX1MPR	Red
JBX1MPV	Green
JBX1MPO	Orange

The overall length is 25 mm/0.98" longer with the protective boot.
Note: The protective boot is not a sealing element.

Tooling for crimp contacts

Crimp tooling



Part number
MIL-22520/7-01

Locator



Part number	
Male	Female
JBX10UTLP07	JBX10UTLS07

Extraction tool



Part number
JBXOUTDC07



JMX1-08 (8 x Ø 0.7 mm / 8 x Ø 0.027")

Contacts

Ø 0.7 mm / Ø 0.027"	Contact type	Plating	Contact locking type	AWG
Solder	Machined	0.5 µm gold over 3 to 5 µm Ni	Fixed	22 and smaller
Crimp	Machined	0.5 µm gold over 3 to 5 µm Ni	Removable	22 - 24 - 26

For more information see pages 55 to 56

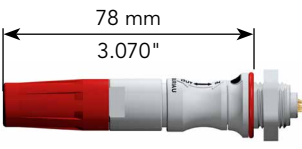
Mated connector length

FH Plug + Receptacle		
 <p>51 mm 2.007"</p> <p>with HH</p>	 <p>78 mm 3.070"</p> <p>with Boot and HH</p>	 <p>61 mm 2.401"</p> <p>with Overmolding and HH</p>

Connector

IEC / UL characteristics	
<p>IEC 5A 840 Vdc 1.5 kV 2</p>	<p>UL 5A 100V UL94 V-0</p>

JMX1-10 (10 x Ø 0.5 mm / 10 x Ø 0.019")

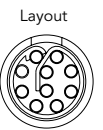

Connector part number (Products without color coding)

Contact type	Connector type	Description	Part number	
			Male insert	Female insert
Solder contacts see page 47	Receptacle	Front mount, nut fixing (HH) ☁	JMXHH1G10MSUDSU	JMXHH1G10FSUDSU
	Plug	Straight plug (FH) *	JMXFH1G10MSUDSU	JMXFH1G10FSUDSU

* In order to get the back nut version for protective boot, replace the "S" by a "M". Example: JMX Straight Plug, size 1, 10 solder contacts, male insert = JMXFH1G10MSUDMU. The protective boot need to be ordered separately. See page accessories.

☁ : Sealed in Unmated Condition

Overmolded cable assembly part number

Layout	Description	Connector and overmold type		Length*		
		Connector	Overmold type	1m / 39.370"	2m / 78.740"	3m / 118.110"
1-02	Plug overmolded cable assembly	Male plug	Straight	HAOJMXFH1G10MSU100	HAOJMXFH1G10MSU200	HAOJMXFH1G10MSU300
		Female plug	Straight	HAOJMXFH1G10FSU100	HAOJMXFH1G10FSU200	HAOJMXFH1G10FSU300

* : Other lengths or specific design requirement please consult us

JMX1-10 (10 x Ø 0.5 mm / 10 x Ø 0.019")

Dimensions (For mated connector lengths see page 47)

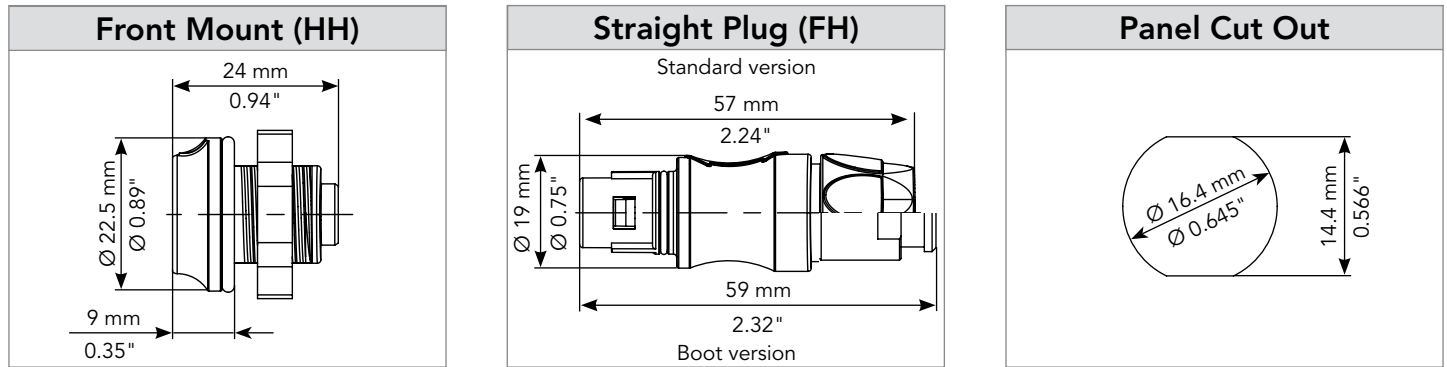

Connector color coding

Color	Coding	Part number ⁽¹⁾		
		Receptacle	Plug	Overmolded
None	U	JMXHH1G10 .UDSU	JMXFH1G10 .UDSU	HA0JMXFH1G10 .U***
Blue	A	JMXHH1G10 .UDSA	JMXFH1G10 .UDSA	HA0JMXFH1G10 .A***
Purple	P	JMXHH1G10 .UDSP	JMXFH1G10 .UDSP	HA0JMXFH1G10 .P***
Grey	G	JMXHH1G10 .UDSG	JMXFH1G10 .UDSG	HA0JMXFH1G10 .G***
Yellow	J	JMXHH1G10 .UDSJ	JMXFH1G10 .UDSJ	HA0JMXFH1G10 .J***
Brown	M	JMXHH1G10 .UDSM	JMXFH1G10 .UDSM	HA0JMXFH1G10 .M***
Black	N	JMXHH1G10 .UDSN	JMXFH1G10 .UDSN	HA0JMXFH1G10 .N***
Red	R	JMXHH1G10 .UDSR	JMXFH1G10 .UDSR	HA0JMXFH1G10 .R***
Green	V	JMXHH1G10 .UDSV	JMXFH1G10 .UDSV	HA0JMXFH1G10 .V***
Orange	O	JMXHH1G10 .UDSO	JMXFH1G10 .UDSO	HA0JMXFH1G10 .O***

1: Standard HH receptacle is delivered without color identification. To order a receptacle or a plug with a color, replace the final "U" by the color code from the table above.

". . .": first "." = gender, second "." = termination.

"***": harness length = 100 (1m), 200 (2m) or 300 (3m).

Example : JMXHH1G10MSUDSU (no color identification) => JMXHH1G10MSUDSV (Green color identification).

JMX1-10 (10 x Ø 0.5 mm / 10 x Ø 0.019")

Accessories

Receptacle dust cap



Part number
JMXBR1

Plug dust cap



Part number
JMXBF1

Plug protective boot

Available only for FH, with back nut protective boot 



Part number	Color
JBX1MPA	Blue
JBX1MPB	White
JBX1MPG	Grey
JBX1MPJ	Yellow
JBX1MPM	Brown
JBX1MPN	Black
JBX1MPR	Red
JBX1MPV	Green
JBX1MPO	Orange

The overall length is 25 mm/0.98" longer with the protective boot.
 Note: The protective boot is not a sealing element.



JMX1-10 (10 x Ø 0.5 mm / 10 x Ø 0.019")

Contacts

Ø 0.5 mm / Ø 0.019"	Contact type	Plating	Contact locking type	AWG
Solder	Machined	0.5 µm gold over 3 to 5 µm Ni	Fixed	28 and smaller
Crimp	Not available			

For more information see pages 55 to 56

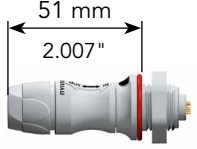
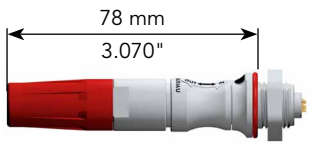
Mated connector length

FH Plug + Receptacle		
 <p>51 mm 2.007"</p> <p>with HH</p>	 <p>78 mm 3.070"</p> <p>with Boot and HH</p>	 <p>61 mm 2.401"</p> <p>with Overmolding and HH</p>

IEC / UL characteristics	
<p>IEC 2.5A 840 Vdc 1.5 kV 2</p>	<p>UL 2.5A 100V UL94 V-0</p>

JMX1-12 (12 x Ø 0.5 mm / 12 x Ø 0.019")

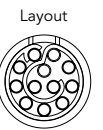

Connector part number (Products without color coding)

Contact type	Connector type	Description	Part number	
			Male insert	Female insert
Solder contacts see page 51	Receptacle	Front mount, nut fixing (HH) ☁	JMXHH1G12MSUDSU	JMXHH1G12FSUDSU
	Plug	Straight plug (FH) *	JMXFH1G12MSUDSU	JMXFH1G12FSUDSU

* In order to get the back nut version for protective boot, replace the "S" by a "M". Example: JMX Straight Plug, size 1, 12 solder contacts, male insert = JMXFH1G12MSUDMU.
The protective boot need to be ordered separately. See page accessories.

☁ : Sealed in Unmated Condition

Overmolded cable assembly part number

Layout	Description	Connector and overmold type		Length*		
		Connector	Overmold type	1m / 39.370"	2m / 78.740"	3m / 118.110"
1-02	Plug overmolded cable assembly	Male plug	Straight	HA0JMXFH1G12MSU100	HA0JMXFH1G12MSU200	HA0JMXFH1G12MSU300
		Female plug	Straight	HA0JMXFH1G12FSU100	HA0JMXFH1G12FSU200	HA0JMXFH1G12FSU300

* : Other lengths or specific design requirement please consult us

JMX1-12 (12 x Ø 0.5 mm / 12 x Ø 0.019")

Dimensions (For mated connector lengths see page 51)

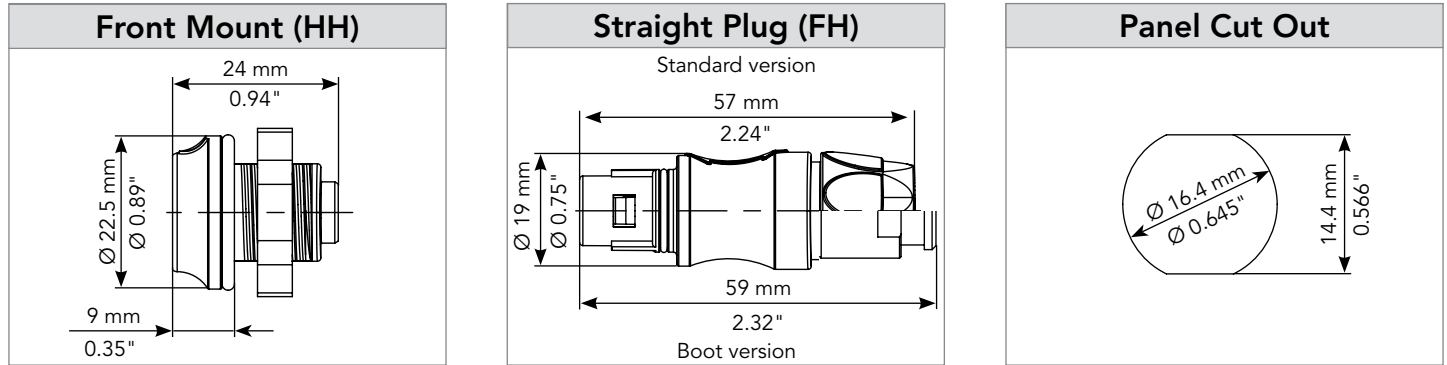

Connector color coding

Color	Coding	Part number ⁽¹⁾		
		Receptacle	Plug	Overmolded
None	U	JMXHH1G12..UDSU	JMXFH1G12..UDSU	HA0JMXFH1G12..U***
Blue	A	JMXHH1G12..UDSA	JMXFH1G12..UDSA	HA0JMXFH1G12..A***
Purple	P	JMXHH1G12..UDSP	JMXFH1G12..UDSP	HA0JMXFH1G12..P***
Grey	G	JMXHH1G12..UDSG	JMXFH1G12..UDSG	HA0JMXFH1G12..G***
Yellow	J	JMXHH1G12..UDSJ	JMXFH1G12..UDSJ	HA0JMXFH1G12..J***
Brown	M	JMXHH1G12..UDSM	JMXFH1G12..UDSM	HA0JMXFH1G12..M***
Black	N	JMXHH1G12..UDSN	JMXFH1G12..UDSN	HA0JMXFH1G12..N***
Red	R	JMXHH1G12..UDSR	JMXFH1G12..UDSR	HA0JMXFH1G12..R***
Green	V	JMXHH1G12..UDSV	JMXFH1G12..UDSV	HA0JMXFH1G12..V***
Orange	O	JMXHH1G12..UDSO	JMXFH1G12..UDSO	HA0JMXFH1G12..O***

1: Standard HH receptacle is delivered without color identification. To order a receptacle or a plug with a color, replace the final "U" by the color code from the table above.
 ". . .": first "." = gender, second "." = termination.
 "***": harness length = 100 (1m), 200 (2m) or 300 (3m).
 Example : JMXHH1G12MSUDSU (no color identification) => JMXHH1G12MSUDSV (Green color identification).

JMX1-12 (12 x Ø 0.5 mm / 12 x Ø 0.019")

Accessories

Receptacle dust cap



Part number
JMXBR1

Plug dust cap



Part number
JMXBF1

Plug protective boot

Available only for FH, with back nut protective boot 



Part number	Color
JBX1MPA	Blue
JBX1MPB	White
JBX1MPG	Grey
JBX1MPJ	Yellow
JBX1MPM	Brown
JBX1MPN	Black
JBX1MPR	Red
JBX1MPV	Green
JBX1MPO	Orange

The overall length is 25 mm/0.98" longer with the protective boot.
 Note: The protective boot is not a sealing element.



JMX1-12 (12 x Ø 0.5 mm / 12 x Ø 0.019")

Contacts

Ø 0.5 mm / Ø 0.019"	Contact type	Plating	Contact locking type	AWG
Solder	Machined	0.5 µm gold over 3 to 5 µm Ni	Fixed	28 and smaller
Crimp	Not available			

For more information see pages 55 to 56

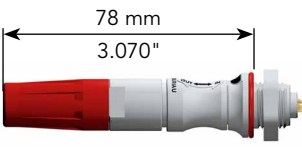
Mated connector length

FH Plug + Receptacle		
 <p>51 mm 2.007"</p> <p>with HH</p>	 <p>78 mm 3.070"</p> <p>with Boot and HH</p>	 <p>61 mm 2.401"</p> <p>with Overmolding and HH</p>

IEC / UL characteristics	
<p>IEC 2.5A 840 Vdc 1.5 kV 2</p>	<p>UL 2.5A 100V UL94 V-0</p>

JMX SERIES

Contacts

■ Description	54
■ Packaging	54
■ Solder contacts	55
■ Crimp contacts	56
■ Tooling	57



Contacts

Description

The JMX Series is delivered with golded machined contacts to ensure the 2,000 cycles mating/unmating resistance. SOURIAU contacts are designed for simple snap-in installation and therefore eliminate the need for insertion tooling.

Please note that solder contacts diam 0.7 mm and diam 0.5 mm are not available in spare parts



• Solder



• Crimp

Packaging for contacts. Not available for solder contacts Ø 0.7 mm & Ø 0.5 mm

Due to the wide variety of applications, contact packaging is offered in bulk package.



• 100 pieces loose package

Solder contacts

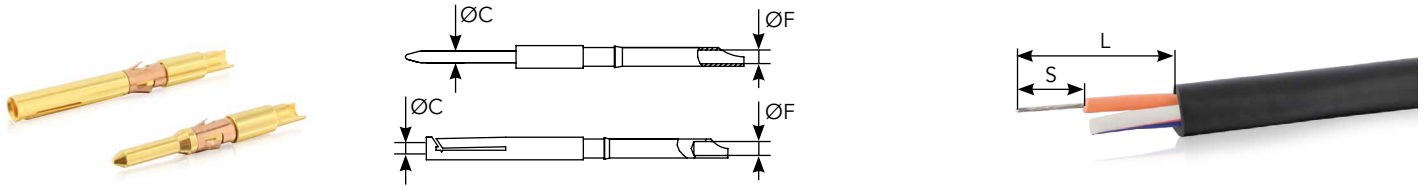

Contact size ØC	ØF		Wire size (Stranded)		Part number		Max current rating (A)	Contact resistance (mΩ)
	mm	inch	AWG (maxi)	mm ² (maxi)	Male	Female		
#24 Ø 0.5 mm / Ø 0.019"	0.50	0.019"	28	0.09	Not available	Not available	5	10
#22 Ø 0.7 mm / Ø 0.027"	0.80	0.031"	22	0.34	Not available	Not available	7	5
#20 Ø 0.9 mm / Ø 0.035"	0.80	0.031"	22	0.34	JBX1CTMS09	JBX1CTFS09	10	3.5
#18 Ø 1.3 mm / Ø 0.051"	1.10	0.043"	20	0.50	JBX1CTMS13	JBX1CTFS13	15	3

* Part numbers for removal contacts only

Wire stripping instructions

Contact size	L		S	
	mm	inch	mm	inch
#24 Ø 0.5 mm / Ø 0.019"	20	0.790"	2	0.079"
#22 Ø 0.7 mm / Ø 0.027"	20	0.790"	3	0.118"
#20 Ø 0.9 mm / Ø 0.035"	20	0.790"	3	0.118"
#18 Ø 1.3 mm / Ø 0.051"	20	0.790"	3.5	0.138"

Contacts

Crimp contacts (Not available in Ø 0.5 mm versions)

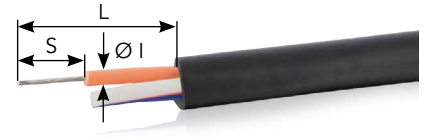
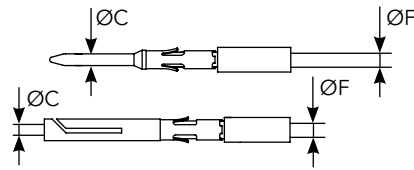

Contact size ØC	ØF		Wire size (Stranded)		Part number*		Max current rating (A)	Contact resistance (mΩ)
	mm	inch	AWG (min-maxi)	mm ² (min-maxi)	Male	Female		
#22 Ø 0.7 mm/ Ø 0.027"	0.85	0.033"	26-22	0.14-0.34	JBX1CTMC07	JBX1CTFC07	7	5
#20 Ø 0.9 mm/ Ø 0.035"	1.10	0.043"	24-20	0.25-0.50	JBX1CTMC09	JBX1CTFC09	10	3.5
#18 Ø 1.3 mm/ Ø 0.051"	1.40	0.055"	22-18	0.50-1.00	JBX1CTMC13	JBX1CTFC13	15	3

* Part numbers for removal contacts only

Wire stripping instructions

Contact size	Ø I (diameter over insulation)		L		S	
	mm	inch	mm	inch	mm	inch
#22 Ø 0.7 mm/ Ø 0.027"	> 1.35	≤ 0.053"	20	0.790"	4	0.157"
	> 1.35	> 0.053"			5.5	0.217"
#20 Ø 0.9 mm/ Ø 0.035"	≤ 1.60	≤ 0.062"	20	0.790"	4	0.157"
	> 1.60	> 0.062"			5.5	0.217"
#18 Ø 1.3 mm/ Ø 0.051"	≤ 2.10	≤ 0.082"	20	0.790"	4	0.157"
	> 2.10	> 0.082"			5.5	0.217"

Tooling

Crimp tool table

Crimp contacts

Contact size	Shell type	Part number*		Crimp tooling	Locator		Extraction tools
		Male	Female		Male	Female	
#22 Ø 0.7 mm/ Ø 0.027"	1	JBX1CTMC07	JBX1CTFC07	MIL-22520/7-01	JBX10UTLP07	JBX10UTLS07	JBXOUTDC07
#20 Ø 0.9 mm/ Ø 0.035"	1	JBX1CTMC09	JBX1CTFC09	MIL-22520/7-01	JBX10UTLP09	JBX10UTLS09	JBXOUTDC09
#18 Ø 1.3 mm/ Ø 0.051"	1	JBX1CTMC13	JBX1CTFC13	MIL-22520/7-01	JBX10UTLP13	JBX10UTLS13	JBXOUTDC13

* Part numbers for removal contacts only

Contact extraction instruction

- Place the tool into the cavity from front face of the insulator
- Push on the handle
- Remove the contact by pulling on it.



JMX SERIES

Technical Information

■ Receptacle assembly instructions	60
■ Plug assembly instructions	61
■ Which Standard to select ?	62
■ UL94 + UL1977	63
■ IEC 61984 & IP codes explained	66
■ What is NEMA Rating ?	68
■ What is CE Marking ?	68
■ Sterilization	69
■ Ethernet for the Layman	70

JMX receptacle assembly instructions

JMXHH assembly (mounting suggestion)

- 1) Solder or crimp the wires to the contacts (see pages 55 & 56)
- 2) Check carefully the presence of the o-ring on the receptacle
- 3) Place the receptacle in the panel cut out. Make sure the panel thickness is inferior to E maxi
- 4) Screw the hex nut to the bulkhead with a wrench according the recommended tightening torque
- 5) Insert contacts manually in the cavities for removable contacts versions

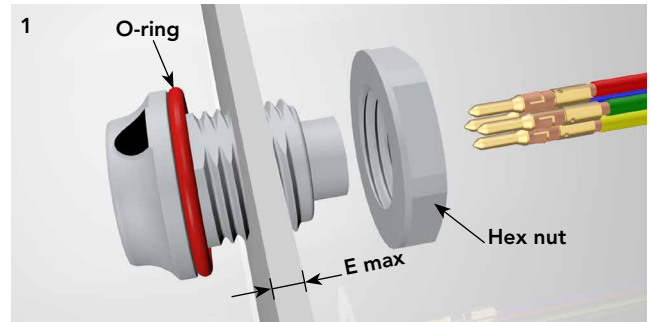

Tightening torque (Nm) maxi	Wrench size	E Panel maxi thicknesses	
		mm	inch
2.5	22 mm	8	0.177"

JMX plug assembly instructions

JMXFH assembly (mounting suggestion)

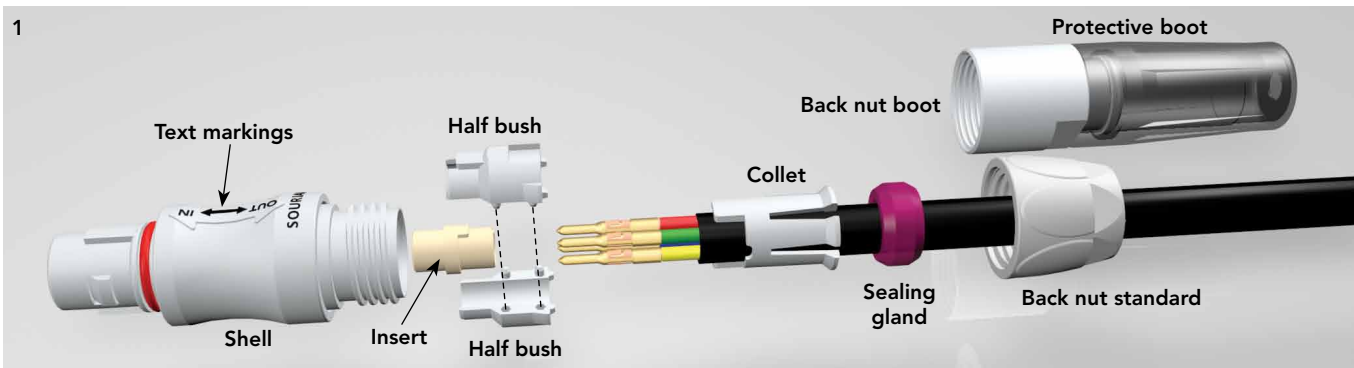

- 1) Slide the backnut, the sealing gland and the appropriate collet onto the cable. See sealing gland and collet table for the diameter choice.
- 2) Strip the external cable jacket and wires (see dimensions pages 55 & 56)
- 3) Solder or crimp the wires to the contacts (see pages 55 & 56).
For removable contacts, insert them manually in the insert
- 4) Place the two half bushes on the insert by aligning the insert keyway and the half bush rib (fig. 2)
- 5) Place the collet making sure that the collet tabs come against the rear face of the halfbushes. The collet will be used as a tool to push the insert inside the shell (fig. 2)
- 6) Place the plug front face against a flat and hard surface (fig. 3)
- 7) With the help of the collet and the sealing gland, push all the sub-assembly in the connector shell until hearing an audible click. Ensure that the rib and the keyways of the half bushes are correctly aligned with the shell keyway (fig. 3)
- 8) Rotate slightly the collet (fig. 4) and push it ensuring an alignment between the letter (fig. 5) and one of the shell flat.
- 9) Slide the sealing gland against the collet and screw the backnut with a wrench according the recommended tightening torque

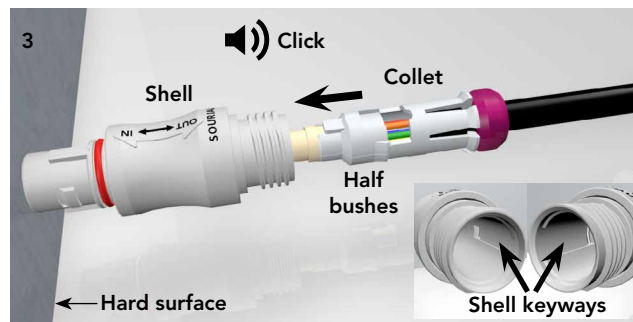
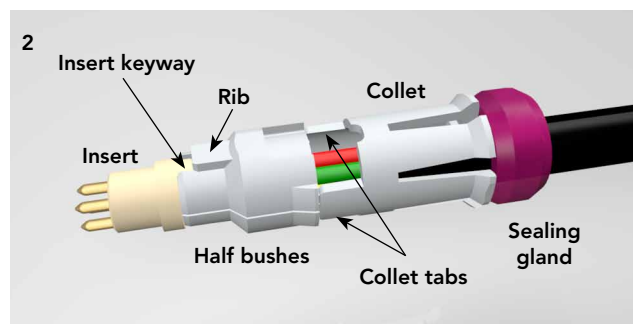

Note: For mass production SOURIAU have available tools to avoid proceeding to the step #7. Please consult us if needed.

Collet selection & sealing gland	
Ø cable maxi	Indice
7.5mm/0.295"	A
6.15mm/0.242"	B
4.8mm/0.189"	C
3.5mm/0.138"	D

Back nut wrench	
Wrench size (mm)	Torque (Nm)
14	1.5

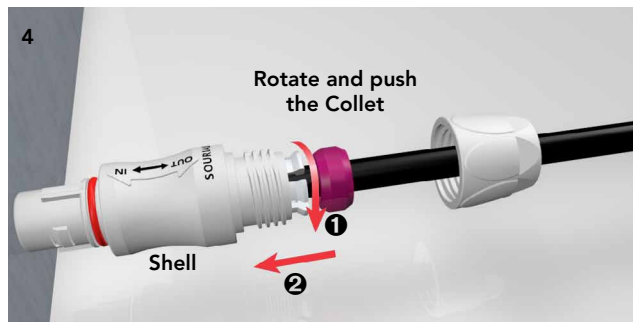
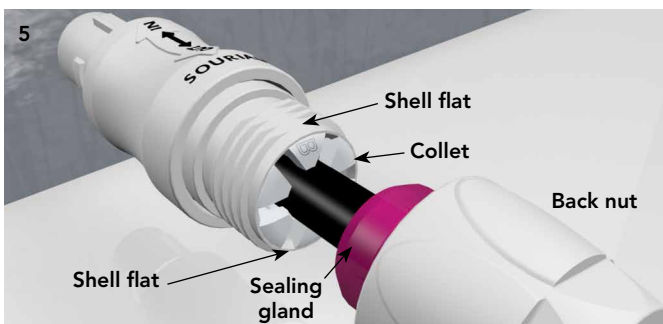

Note: Assembly operations mentioned above shall not interfere or to be in contradiction with the IPC-WHMA-A-620B

Which Standard to select ?

Standard qualification benefits:

Safety and essential performance requirements for "Medical electrical equipments" are defined by the general standard IEC 60601-1. It is a requirement for the commercialization of electrical medical equipments. Compliance to the IEC 60601-1 requests a qualification to component standards as the connector standards UL 1977 (US) and IEC 61984 (Europe). It avoids to re-proceed to a full qualification of the connectors and simplifies the equipment qualification process. JMX connectors are compliant to the UL 1977 and IEC 61984 and therefore ensure a fully compliance with the IEC 60601-1.

IEC 60601-1
General Standard
Medical Electrical Equipment



UL 60601
North America Standard
Medical Electrical Equipment



EN 60601
European Standard
Medical Electrical Equipment



UL 1977 / CSA 22.2
North America Standard



IEC 61984
(SOURIAU relevant standard)
European Connector Standard

UL94 + UL1977

Underwriter laboratories



There are two main standards for industrial connectors: UL94 & UL1977

UL94

This standard is dedicated to plastics flammability. It characterizes how the material burns in various orientation and thicknesses.

The JMX Plastic series is rated at **V-0**.

Procedure: A specimen is supported in a vertical or horizontal position and a flame is applied to the bottom of the specimen. The flame is applied for ten seconds and then removed until flaming stops, at which time the flame is reapplied for another ten seconds and then removed. Two sets of five specimens are tested.

More details on the Flammability UL 94 could be found on the following link:
www.ulitc.com/en/solutions/test-methods/combustion-fire.html

V-0 Vertical burning:

- Specimens must not burn with flaming combustion for more than 10 seconds after each test flame application
- Total flaming combustion time must not exceed 50 seconds for each set of 5 specimens
- Specimens must not burn with flaming or glowing combustion up to the specimen holding clamp
- Specimens must not drip flaming particles that ignite the cotton
- No specimen can have glowing combustion remain for longer than 30 seconds after removal of the test flame.

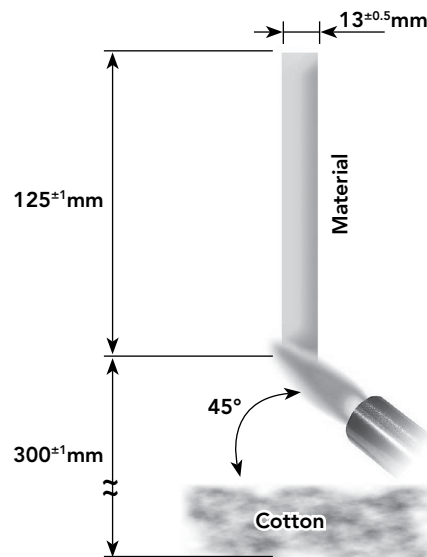

UL94 + UL1977



UL1977

The connector standard UL1977 covers single and multipole connectors intended for factory assembly. Requirements apply to devices taking into account intensity and voltage. The categories are as follow:

	0	30 V (42 V peak)	600 V	6000 V
0	Type 0	Type 1A	Type 5	
8.3 A				
31 A	Type 1B	Type 2	Type 5	
200 A		Type 3		
1000 A	Type 4			

According to above table, the level of performance to be reached could be different. Most of them are explained in the following page.

Insulating materials:

For all the types described in the above table, JMX inserts are rated V0 and have a RTI of 130°C / 266°F.

Assembly:

Connector has to be keyed to prevent any mismatching that can damage the machine or hurt the user. In the same way, plugs and sockets have to be equipped to protect persons against contact with live parts.

UL94 + UL1977



UL1977

Spacing / Dielectric Withstanding Voltage:

UL1977 defines minimum clearance and creepage distances for voltage below and above 250V. An alternative way to determine voltage rating is the Dielectric Withstanding Voltage (DWW) test. No arc-over or breakdown must occur during one minute.

Different Dielectric Withstanding Voltage requirements shall be considered depending on the connector type. DWW requirement are shown in the table below.

• **Applicability of spacing requirements**

Type	Current rating (A)	U=Voltage rating (Vrms)	Dielectric Withstanding Voltage requirement to considered (during 1 minute)
0	0 to 8.3	0 to 30	No requirement for type 0
1A	0 to 8.3	30 to 600	2U+1,000
1B	8.3 to 200	0 to 30	500V Minimum
2	8.3 to 31	30 to 600	2U+1,000
3	31 to 200	30 to 600	2U+1,000
4	200 to 1,000	0 to 600	2U+1,000
5	0 to 31	600 to 6,000	2,200V Minimum

Marking:

A device shall be legibly marked with the manufacturer's trade name, trade mark, or other descriptive marking by which the organization responsible for the product may be identified. (Exception: If the device is too small, or where the legibility would be difficult to attain, the manufacturer's name, trademark, or other descriptive marking may appear on the smallest unit container or carton)

The following shall be marked on the device or on the smallest unit container or carton or on a stuffer sheet in the smallest unit container or carton:

- a) The catalog number or an equivalent designation
- b) The electrical rating in both volts and amperes, if assigned
- c) Whether ac or dc, if restricted
- d) Flammability class, if identified

Example - Marking for the 2 contacts layout:

10A 300V UL94 V-0

IEC 61984 & IP codes explained

IEC 61984

This standard is dedicated to connectors with rated voltage above 50V and up to 1000V and rated currents up to 125A per contact. Depending on your application connectors should be compliant with another standard. This has to be double checked with the customer.

There are a lot of constructional requirements and performances specified in that standard. Most of them are illustrated in greater details hereafter.

IP code:

IP is a coding system defined by the IEC 60529 to indicate the degrees of protection provided by an enclosure. The aim of this is to give information regarding the accessibility of live parts against ingress of water and other foreign bodies.

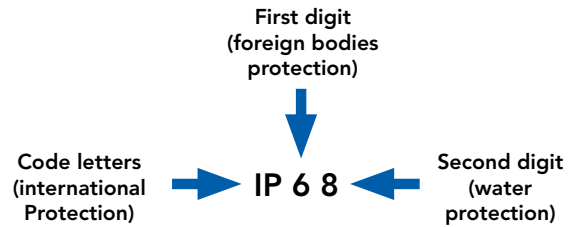

1 st digit	Degree of protection	2 nd digit	Degree of protection
0	No protection against accidental contact. No protection against solid foreign bodies.	0	No protection against water.
1	Protection against contact with any large area by hand and against large solid foreign bodies with a diameter bigger than 50 mm.	1	Drip-proof. Protection against vertical water drips.
2	Protection against contact with the fingers. Protection against solid foreign bodies with a diameter bigger than 12 mm.	2	Drip-proof. Protection against water drips up to a 15° angle.
3	Protection against tools, wires or similar objects with a diameter bigger than 2.5 mm. Protection against small solid bodies with a diameter bigger than 2.5 mm.	3	Spray-proof. Protection against diagonal water drips up to a 60° angle.
4	Same as 3 however diameter is bigger than 1 mm.	4	Splash-proof. Protection against splashed water from all directions.
5	Full protection against contact. Protection against interior injurious dust deposits.	5	Hose-proof. Protection against water (out of a nozzle) from all directions.
6	Total protection against contact. Protection against penetration of dust.	6	Protection against temporary flooding.
		7	Protection against temporary immersions.
		8	Protection against water pressure. Pressure to be specified by supplier.

JMX offers high sealing performance IP68 (1bar during 1 week):

- In mated condition Plug + Receptacle
- In mated condition with the caps
- In unmated condition for solder Receptacles

IEC 61984 ed.2.0 "Copyright © 2008 IEC Geneva, Switzerland.www.iec.ch"
IEC 60664-1 ed.2.0 "Copyright © 2007 IEC Geneva, Switzerland.www.iec.ch"

IEC 61984 & IP codes explained

IEC 61984

Overvoltage

Per the IEC 60664-1 (formerly VDE 0110) each category is linked to the end application and where the device will be implemented:

- **Category IV** (primary overcurrent protection equipment):
Origin of the installation
- **Category III** (Any fixed installation with a permanent connection)
Fixed installation and equipment and for cases where the reliability and the availability is subject to special requirements
- **Category II** (Domestic appliances):
Energy consuming equipment to be supplied from the fixed installation
- **Category I** (Protected electronic circuit):
For connection to circuit in which measures are taken to limit transient overvoltage.

The "Nominal Voltage" will define for what category JMX connectors could be used. The "Rated Impulse voltage" of the JMX is 1500V. Below a table showing the applicable categories:

Nominal voltage of the supply system based on IEC 60038		Voltage line to neutral derived from nominal voltages a.c. or d.c. up to and including V	Rated impulse voltage			
Three phase	Single phase		Overvoltage category (V)			
			I	II	III	IV
		50	330	500	800	1,500
		100	500	800	1,500	2,500
	120-240	150	800	1,500	2,500	4,000
230/400 277/480		300	1,500	2,500	4,000	6,000
400/690		600	2,500	4,000	6,000	8,000
1,000		1,000	4,000	6,000	8,000	12,000

■ Nominal Voltage ■ Rated Impulse Voltage ■ Non recommended voltage

Pollution degree

Per the IEC 60664-1 (formerly VDE 0110) the environment affects the performance of the insulation. Particles can build a bridge between two metal parts. As a rule dust mixed with water can be conductive and more generally speaking metal dust is conductive. Finally, the standard defines 4 levels of pollution:

- **Degree 1** (Air conditioned dry room):
No pollution or only dry, non conductive pollution occurs. The pollution has no influence.
- **Degree 2** (Personal computer in a residential area):
Only non conductive pollution occurs except that occasionally a temporary conductivity caused by condensation is to be expected.
- **Degree 3** (Machine tools):
Conductive pollution occurs or dry non-conductive pollution occurs which becomes conductive due to condensation which is to be expected.
- **Degree 4** (Equipments on roof, locomotives):
Continuous conductivity occurs due to conductive dust, rain or other wet conditions.

Finally, the harsher the environment is, the longer clearance and creepage distances should be.

Marking

The marking should give enough details to the user to know what the main characteristics are and without going deep in technical documentation. Below is an example of how JMX packagings are marked.

Rated current 10A, working voltage 840 Vdc, rated Impulse voltage 1.5kV, Pollution degree 2

10A 840 Vdc 1.5 kV 2

What is NEMA Rating ?

- NEMA ratings vs IP ratings

Whereas IP ratings only consider protection against ingress of foreign bodies (first digit) and ingress of water (second digit), NEMA ratings consider these but also verify protection from external ice, corrosive materials, oil immersion, etc.

The correlation between NEMA & IP being limited only to dust and water, we can state that a NEMA type is equivalent to an IP rating but it is not possible to say the contrary.

Below a list of some NEMA standards:

Enclosure rating	IP20	IP22	IP55	IP64	IP65	IP66	IP67	IP68
Type 1	•							
Type 3				•				
Type 3R		•						
Type 3S				•				
Type 4						•		
Type 4X						•		
Type 6							•	
Type 6P								•
Type 12			•					
Type 13					•			

• indicates compliance



Type 6 rating can be either Type 6 or Type 6P - please see below:

6	IP67	Enclosures constructed for either indoor or outdoor use to provide a degree of protection to personnel against incidental contact with the enclosed equipment, falling dirt, hose-directed water, the entry of water during occasional temporary submersion at a limited depth and damage from external ice formation.
6P	IP68	Enclosures constructed for either indoor or outdoor use to provide a degree of protection to personnel against incidental contact with the enclosed equipment, falling dirt, hose-directed water, the entry of water during prolonged submersion at a limited depth and damage from external ice formation.

What is CE Marking ?

CE marking means that the device complies with the European safety directives.

CE marking **does not apply to components such as connectors** but only on complete equipment.

Sterilization

Steam autoclave sterilization:

JMX connectors withstand up to 200 cycles on steam autoclave sterilization according to gravitation or pre-vacuum process per EN13060.

Both processes are described below:

- Gravity process: Steam displaces air in the chamber by gravity through a drain port.
- Pre-vacuum process: The air is removed from the chamber and steam is injected through a series of vacuum and pressure pulses. This allows the steam to penetrate porous areas of the load that could not otherwise be reached with simple gravity displacement.

Cycle is defined at 134°C / 273.2°F during 4 min.

JMX is qualified to ensure a Sterility Assurance Level (SAL) of 10^{-6} for re-usable medical devices sterilized according to ISO 14937 & ISO 17665-1 with a pre-vacuum process.

For other sterilization processes, please contact us.

SOURIAU is equipped with autoclave devices to proceed with additional tests if needed.



Ethernet for the Layman

In order to explain basic Ethernet theory, we can use a functional comparison to a busy city with highways, buildings and cars. To illustrate this, the table below provides correlation between the different components/pieces/links that encompass Ethernet network connectivity, and the larger scale infrastructure of a metropolitan city.

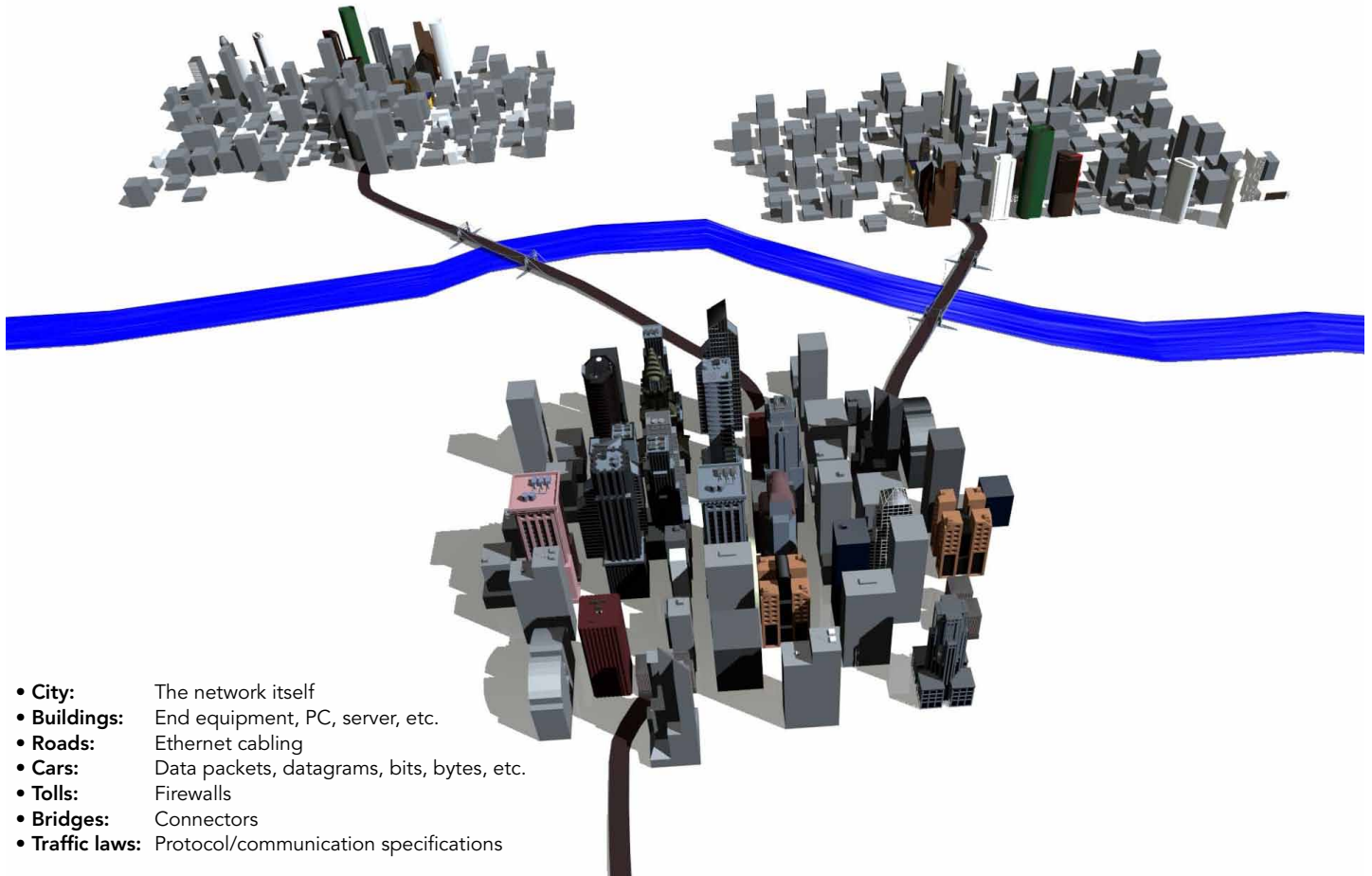

Ethernet Basics

Ethernet is a widely used communications protocol that is used to transmit data packets (datagrams) between network devices. Imagine a highway in a large metropolitan area six lanes wide at rush hour. The vehicles on the highway need rules to follow so that they get to their destination without crashing into each other. In an Ethernet network link, there could be 100 million bits of information transmitted in one second. In the Ethernet standard, there exist rules to govern packet structure, transmission requirements, error correction, communication with end equipment, etc.

Examining the differences between 100Mhz, 100 Base TX, Cat5e/Cat6. What does it all mean?

When discussing connectors and Ethernet, there are a few key details to be aware of:

- 100Mhz is a measurement of Frequency for the signal
 - Comparable to the Speed Limit of a highway
- 100BaseTX (or Fast Ethernet) is an Ethernet link standard and identifies available link bandwidth. The bandwidth is measured in units of Mbits/S (megabits per second)
 - Comparable to the number of cars that pass a point in one second
- Cat5e/Cat6 are an EIA/TIA standard for performance and physical characteristics for cables and connectors
 - Comparable to performance specifications of the car and highway.

In connectors and cables, Fast Ethernet uses 2 pairs. One for transmit and one for receive. This way data traffic can flow in both directions simultaneously.

Notes

A large grid area for taking notes, consisting of 20 columns and 30 rows of small squares.

JMX SERIES

Appendices

■ Glossary of Terms	74
■ Part Number Index	75



Glossary of terms

• **Clearance**

Per the IEC 60664-1 it is the shortest distance between two conductive parts even over the air.

• **Creepage distance**

Per the IEC 60664-1 it represents the shortest distance along the surface of the insulating material between two conductive parts.

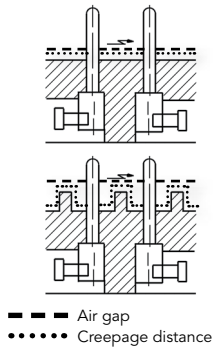

• **Test Voltage**

Measured according to the IEC 60512-2 test 4a, Test voltage corresponds to 75% of the mean dielectric withstanding voltage.

Operating voltage: It could be calculated following the method:

$$\frac{\text{Test Voltage}}{3}$$

• **Rated impulse voltage**

Impulse withstands voltage value assigned by the manufacturer to the equipment or to a part of it characterizing the specified withstand capability of its insulation against transient overvoltage.

• **Working current**

It is the maximum continuous and not interrupted current able to be carried by all contacts without exceeding the maximum temperature of the insulating material.

• **Transient voltage**

Extract from the IEC 60664-1: Short duration overvoltage of a few millisecond or less, oscillatory or non-oscillatory, usually highly damped.

• **CTI (Comparative Tracking Index)**

The CTI value is commonly used to characterize the electrical breakdown properties of an insulating material. It allows users to know the tendency to create creepage paths. This value represents the maximum voltage after 50 drops of ammonium chloride solution without any breakdown.

• **RTI (Relative temperature Index):**

Extract from ULs website:

Maximum service temperature for a material, where a class of critical property will not be unacceptably compromised through chemical thermal degradation, over the reasonable life of an electrical product, relative to a reference material having a confirmed, acceptable corresponding performance defined RTI.

- **RTI Elec:** Electrical RTI, associated with critical electrical insulating properties.
- **RTI Mech Imp:** Mechanical Impact RTI, associated with critical impact resistance, resilience and flexibility properties.
- **RTI Mech Str:** Mechanical Strength (Mechanical without Impact) RTI, associated with critical mechanical strength where impact resistance, resilience and flexibility are not essential.

Part number index

Connectors

JMXFH1G02FCUDSU.....	P. 16
JMXFH1G02FSUDSU.....	P. 16
JMXFH1G02MCUDSU.....	P. 16
JMXFH1G02MSUDSU.....	P. 16
JMXFH1G03FCUDSU.....	P. 20
JMXFH1G03FSUDSU.....	P. 20
JMXFH1G03MCUDSU.....	P. 20
JMXFH1G03MSUDSU.....	P. 20
JMXFH1G04FCUDSU.....	P. 24
JMXFH1G04FSUDSU.....	P. 24
JMXFH1G04MCUDSU.....	P. 24
JMXFH1G04MSUDSU.....	P. 24
JMXFH1G05FCUDSU.....	P. 28
JMXFH1G05FSUDSU.....	P. 28
JMXFH1G05MCUDSU.....	P. 28
JMXFH1G05MSUDSU.....	P. 28
JMXFH1G06FCUDSU.....	P. 32
JMXFH1G06FSUDSU.....	P. 32
JMXFH1G06MCUDSU.....	P. 32
JMXFH1G06MSUDSU.....	P. 32
JMXFH1G07FCUDSU.....	P. 36
JMXFH1G07FSUDSU.....	P. 36
JMXFH1G07MCUDSU.....	P. 36
JMXFH1G07MSUDSU.....	P. 36
JMXFH1G08FCUDSU.....	P. 40
JMXFH1G08FSUDSU.....	P. 40
JMXFH1G08MCUDSU.....	P. 40
JMXFH1G08MSUDSU.....	P. 40
JMXFH1G10FSUDSU.....	P. 44
JMXFH1G10MSUDSU.....	P. 44
JMXFH1G12FSUDSU.....	P. 48
JMXFH1G12MSUDSU.....	P. 48
JMXHH1G02FCUDSU.....	P. 16
JMXHH1G02FSUDSU.....	P. 16
JMXHH1G02MCUDSU.....	P. 16
JMXHH1G02MSUDSU.....	P. 16
JMXHH1G03FCUDSU.....	P. 20
JMXHH1G03FSUDSU.....	P. 20
JMXHH1G03MCUDSU.....	P. 20
JMXHH1G03MSUDSU.....	P. 20
JMXHH1G04FCUDSU.....	P. 24
JMXHH1G04FSUDSU.....	P. 24
JMXHH1G04MCUDSU.....	P. 24
JMXHH1G04MSUDSU.....	P. 24
JMXHH1G05FCUDSU.....	P. 28
JMXHH1G05FSUDSU.....	P. 28
JMXHH1G05MCUDSU.....	P. 28
JMXHH1G05MSUDSU.....	P. 28
JMXHH1G06FCUDSU.....	P. 32
JMXHH1G06FSUDSU.....	P. 32
JMXHH1G06MCUDSU.....	P. 32
JMXHH1G06MSUDSU.....	P. 32
JMXHH1G07FCUDSU.....	P. 36
JMXHH1G07FSUDSU.....	P. 36
JMXHH1G07MCUDSU.....	P. 36
JMXHH1G07MSUDSU.....	P. 36
JMXHH1G08FCUDSU.....	P. 40
JMXHH1G08FSUDSU.....	P. 40
JMXHH1G08MCUDSU.....	P. 40
JMXHH1G08MSUDSU.....	P. 40
JMXHH1G10FSUDSU.....	P. 44
JMXHH1G10MSUDSU.....	P. 44
JMXHH1G12FSUDSU.....	P. 48
JMXHH1G12MSUDSU.....	P. 48

Overmolded cable assembly

HAOJMXFH1G02FCU100.....	P. 16
HAOJMXFH1G02FCU200.....	P. 16
HAOJMXFH1G02FCU300.....	P. 16
HAOJMXFH1G02MCU100.....	P. 16
HAOJMXFH1G02MCU200.....	P. 16
HAOJMXFH1G02MCU300.....	P. 16
HAOJMXFH1G03FCU100.....	P. 20
HAOJMXFH1G03FCU200.....	P. 20
HAOJMXFH1G03FCU300.....	P. 20
HAOJMXFH1G03MCU100.....	P. 20
HAOJMXFH1G03MCU200.....	P. 20
HAOJMXFH1G03MCU300.....	P. 20
HAOJMXFH1G04FCU100.....	P. 24
HAOJMXFH1G04FCU200.....	P. 24
HAOJMXFH1G04FCU300.....	P. 24
HAOJMXFH1G04MCU100.....	P. 24
HAOJMXFH1G04MCU200.....	P. 24
HAOJMXFH1G04MCU300.....	P. 24
HAOJMXFH1G05FCU100.....	P. 28
HAOJMXFH1G05FCU200.....	P. 28
HAOJMXFH1G05FCU300.....	P. 28
HAOJMXFH1G05MCU100.....	P. 28
HAOJMXFH1G05MCU200.....	P. 28
HAOJMXFH1G05MCU300.....	P. 28
HAOJMXFH1G06FCU100.....	P. 32
HAOJMXFH1G06FCU200.....	P. 32
HAOJMXFH1G06FCU300.....	P. 32
HAOJMXFH1G06MCU100.....	P. 32
HAOJMXFH1G06MCU200.....	P. 32
HAOJMXFH1G06MCU300.....	P. 32
HAOJMXFH1G07FCU100.....	P. 36
HAOJMXFH1G07FCU200.....	P. 36
HAOJMXFH1G07FCU300.....	P. 36
HAOJMXFH1G07MCU100.....	P. 36
HAOJMXFH1G07MCU200.....	P. 36
HAOJMXFH1G07MCU300.....	P. 36
HAOJMXFH1G08FCU100.....	P. 40
HAOJMXFH1G08FCU200.....	P. 40
HAOJMXFH1G08FCU300.....	P. 40
HAOJMXFH1G08MCU100.....	P. 40
HAOJMXFH1G08MCU200.....	P. 40
HAOJMXFH1G08MCU300.....	P. 40
HAOJMXFH1G10FSU100.....	P. 44
HAOJMXFH1G10FSU200.....	P. 44
HAOJMXFH1G10FSU300.....	P. 44
HAOJMXFH1G10MSU100.....	P. 44
HAOJMXFH1G10MSU200.....	P. 44
HAOJMXFH1G10MSU300.....	P. 44
HAOJMXFH1G12FSU100.....	P. 48
HAOJMXFH1G12FSU200.....	P. 48
HAOJMXFH1G12FSU300.....	P. 48
HAOJMXFH1G12MSU100.....	P. 48
HAOJMXFH1G12MSU200.....	P. 48
HAOJMXFH1G12MSU300.....	P. 48

Accessories

JBX1MPA.....	P. 18
JBX1MPB.....	P. 18
JBX1MPG.....	P. 18
JBX1MPJ.....	P. 18
JBX1MPM.....	P. 18
JBX1MPN.....	P. 18
JBX1MPO.....	P. 18

JBX1MPR.....	P. 18
JBX1MPV.....	P. 18
JBXBF1.....	P. 18
JBXBR1.....	P. 18

Contacts

JBX1CTFC07.....	P. 56
JBX1CTFC09.....	P. 56
JBX1CTFC13.....	P. 56
JBX1CTFS09.....	P. 55
JBX1CTFS13.....	P. 55
JBX1CTMC07.....	P. 56
JBX1CTMC09.....	P. 56
JBX1CTMC13.....	P. 56
JBX1CTMS09.....	P. 55
JBX1CTMS13.....	P. 55

Tooling

JBX1OUTLP07.....	P. 57
JBX1OUTLP09.....	P. 57
JBX1OUTLP13.....	P. 57
JBX1OUTLS07.....	P. 57
JBX1OUTLS09.....	P. 57
JBX1OUTLS13.....	P. 57
JBXOUTDCS07.....	P. 57
JBXOUTDC09.....	P. 57
JBXOUTDC13.....	P. 57
MIL-22520/7-01.....	P. 57

Reliable People, Reliable Solutions



Your local contact



Our contribution to environmental protection:
This catalog is printed on PEFC certified paper
Advancement of sustainable wood cultivation. www.pefc.org

www.esterline-connection-technologies.com
technical-emear-ect@esterline.com (Europe - Asia - Africa)
technical-americas-ect@esterline.com (North America)



SOURIAU

X-ON Electronics

Largest Supplier of Electrical and Electronic Components

Click to view similar products for [Crimpers / Crimping Tools](#) category:

Click to view products by [Sunbank](#) manufacturer:

Other Similar products are found below :

[010-0096](#) [M225201-06](#) [M225202-37](#) [6-1579015-5](#) [CT150-2-D02](#) [622-6441LF](#) [M322](#) [6-304052-1](#) [63456-0054](#) [63484-3701](#) [63800-8355](#)
[63819-1875](#) [63819-2875](#) [63819-4475](#) [63823-3475](#) [63827-5375](#) [64001-0975](#) [64001-4175](#) [64005-0175](#) [662903-2](#) [690602-6](#) [7-1579001-9](#) [7-](#)
[23471-1](#) [762637-1](#) [808714-1](#) [811242-5](#) [999-50-020083](#) [1-21002-3](#) [1-21002-7](#) [12085270](#) [1-21002-6](#) [1-21113-6](#) [1-22548-4](#) [125442-1](#)
[DCE.91.073.BVC](#) [DCE.91.090.3MVM](#) [DCE.91.130.5MVU](#) [DCE.91.202.BVCM](#) [1338300-1](#) [1-354003-0](#) [1338301-1](#) [DF62/RE-MD](#) [142321](#)
[1456088-1](#) [1490794-1](#) [1-45804-6](#) [1490357-2](#) [1490357-3](#) [AX100749](#) [1-59619-7](#)