

# Aerospace & Military Bayonet Connectors

## MIL-DTL-38999 Series I



# 8LT Series

## MIL-DTL-38999 Series I



### Contents

#### Overview

- 8LT Series - Presentation ..... 06
- 8LT Series - Applications ..... 06
- A universal product platform ..... 07
- Contact layouts ..... 08
- Contact layouts (matrix) ..... 12

#### Series

- 8LT Standard Version:
  - Technical features ..... 16
  - Ordering information ..... 17
  - Dimensions ..... 19
- Backshells:
  - Ordering information ..... 24
  - Dimensions ..... 24
  - Thread information ..... 27
  - Recommended installation torque ..... 27
  - Band-it ..... 27
- 8LT Rack & Panel:
  - Technical features ..... 28
  - Ordering information ..... 29
  - Dimensions ..... 30
  - Panel cut-out ..... 31
- 8LT Resin sealed:
  - Technical features ..... 32
  - Ordering information ..... 33

#### Contacts & Tooling

- Crimp contacts ..... 36
- Straight PC tail contacts ..... 38
- Coaxial contacts #12 ..... 39
- Solder cup ..... 39
- Crimp contacts: 1500 mating ..... 39
- Wire wrap contacts ..... 39
- Quadrax #8 contacts ..... 39
- Thermocouple contacts ..... 40
- Dummy contacts ..... 40
- Filler plugs ..... 40
- Wiring instructions ..... 41
- Crimping tools ..... 42
- Insertion & extraction tools ..... 43

#### Common Section

- Protective caps ..... 46
- Reducers ..... 47
- Boots ..... 48
- Orientations ..... 48
- Panel gasket ..... 49
- Dummy receptacles ..... 49
- Cross reference list ..... 50
- Coordinates information ..... 52

#### Range Extension

- micro38999 ..... 62
- RoHS solution ..... 62
- High density ..... 63
- PCB contact without shoulder ..... 63

8  
BIT  
Series.





## 8LT Series

# Overview

■ 8LT Series - Presentation .....	06
■ 8LT Series - Applications .....	06
■ A universal product platform: MIL-DTL-38999 .....	07
■ A universal product platform: VG96912 & JN1003 .....	07
■ Contact layouts .....	08
■ Contact layouts (matrix) .....	12

# 8LT Series

## MIL-DTL-38999 Series I

### 8LT Series - Presentation

High contact density connectors with high reliability

#### 38999 Series I: 8LT Series

This 8LT product family is qualified in accordance to the MIL-DTL-38999 Series I.

Originally designed to meet the high performance needs of the aerospace industries & military applications, it is also now used in varied applications needing extremely reliable interconnections with high density contact arrangements in a miniature circular shell.



- ▶ Weight and Space Saving
- ▶ Quick Mating - 3 point bayonet lock system
- ▶ Mismatching, error proof positioning - keyway polarization (5 positions)
- ▶ High choice of Insert arrangements (customization possible, please consult us)
- ▶ Range extension available on demand (Rack Panel, Potted, Hermetics, Low Profile, Filters, etc..), please consult us
- ▶ Versatility thanks to our inserts as for the series III (except for 8LT type 2) with full range of crimp contacts interchangeable
- ▶ Gold plated crimp or PC tail contacts are rear removable and retained in the insulator by a metal clip.
- ▶ RoHS version available (cadmium free)

### 8LT Series - Applications



- Civil and Military Aerospace
- Marine Equipments
- Communications Equipements
- Medical Instrumentation
- Ballistic Missiles & Weapon Systems
- Armored Carriers & Tanks
- Test Equipments

# 8LT Series

## MIL-DTL-38999 Series I

### A universal product platform: MIL-DTL-38999

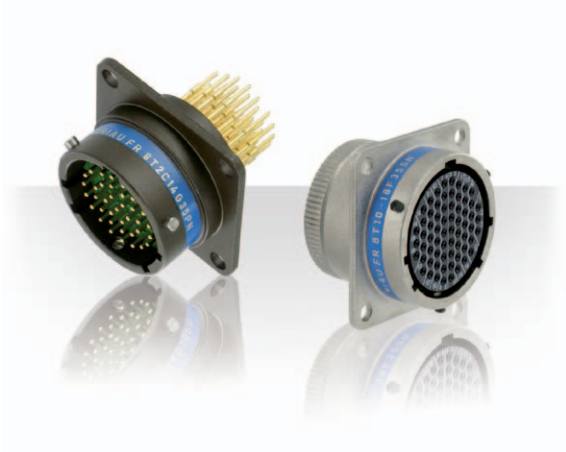

#### 38999 Series II: 8T Series

- ▶ Short version of MIL-DTL-38999 Series I
- ▶ Low profile = lightweight
- ▶ High density MIL-spec circular (1980's)
- ▶ Non-scoop proof, bayonet coupling
- ▶ Method of mounting: screws or jam nut
- ▶ Shell: Aluminum alloy
- ▶ Plating: cadmium, nickel, hard anodized
- ▶ QPL approved
- ▶ Numerous layouts



#### 38999 Series III: 8D Series

- ▶ High density MIL-spec circular (1980's)
- ▶ Scoop proof, fast screw coupling
- ▶ Composite light-weight version available
- ▶ QPL approved
- ▶ Titanium version, light-weight, mechanical and environmental performances
- ▶ Quadrax and Elio version
- ▶ Specific versions (clinch nuts, double flange, high power, hermetic, ...)

### A universal product platform: VG96912 & JN1003



#### 8ST Series

- ▶ High density - same layouts as 38999 Series I
- ▶ Lightweight version of Series I
- ▶ Scoop proof, bayonet coupling
- ▶ Method of mounting: screws or jam nut
- ▶ Shell: Aluminum alloy
- ▶ Plating: olive green cadmium or nickel
- ▶ VG 96912 German specification
- ▶ JN 1003 Typhoon specification

# 8LT Series

## MIL-DTL-38999 Series I

### Contact layouts

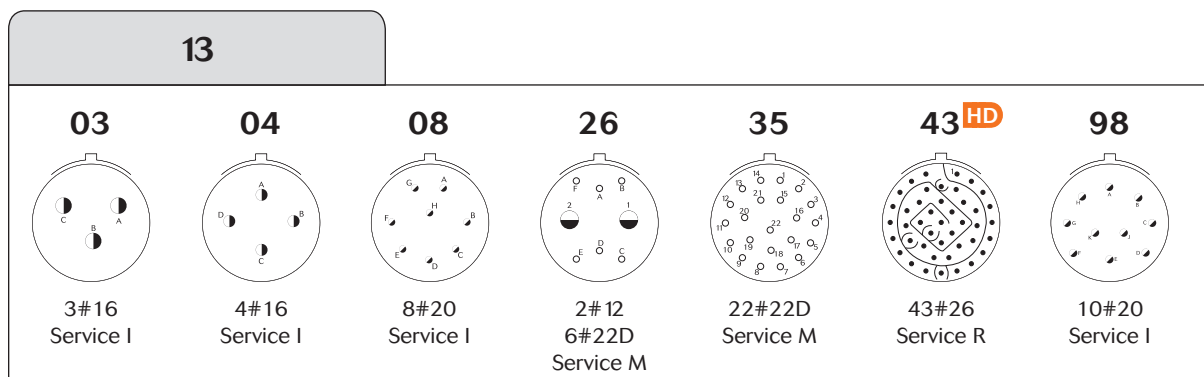
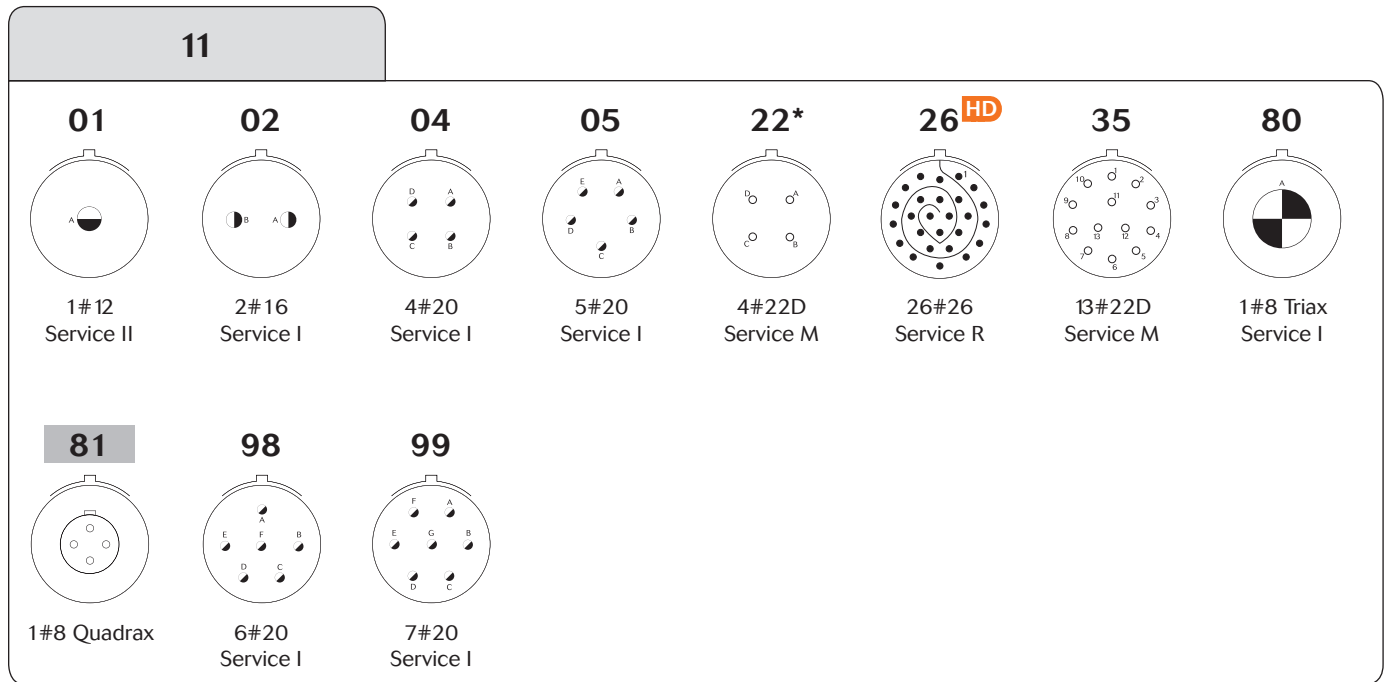
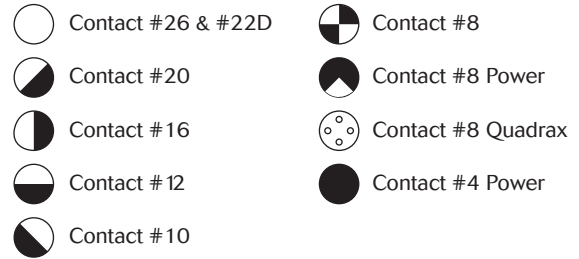
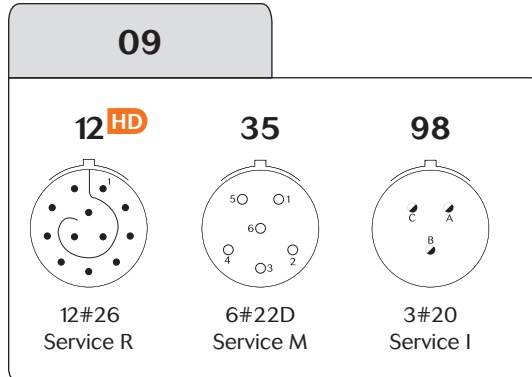

Ethernet Quadrax **HD** High Density layout \* Available on specific request. Please consult us.

# 8LT Series

## MIL-DTL-38999 Series I

### Contact layouts

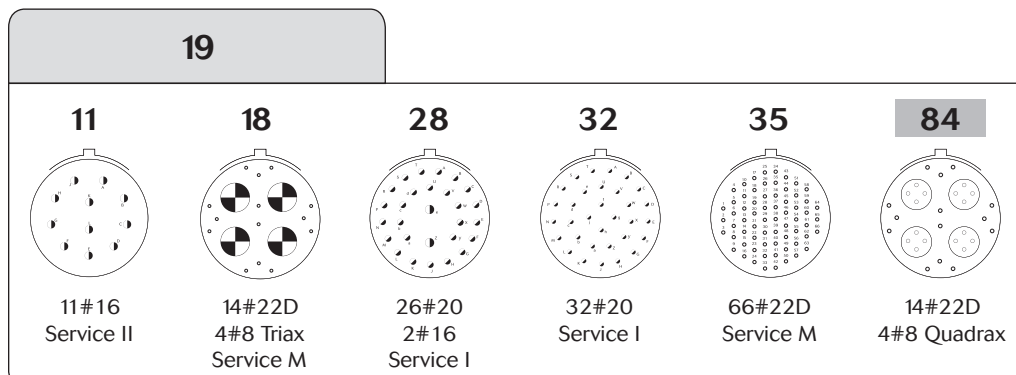
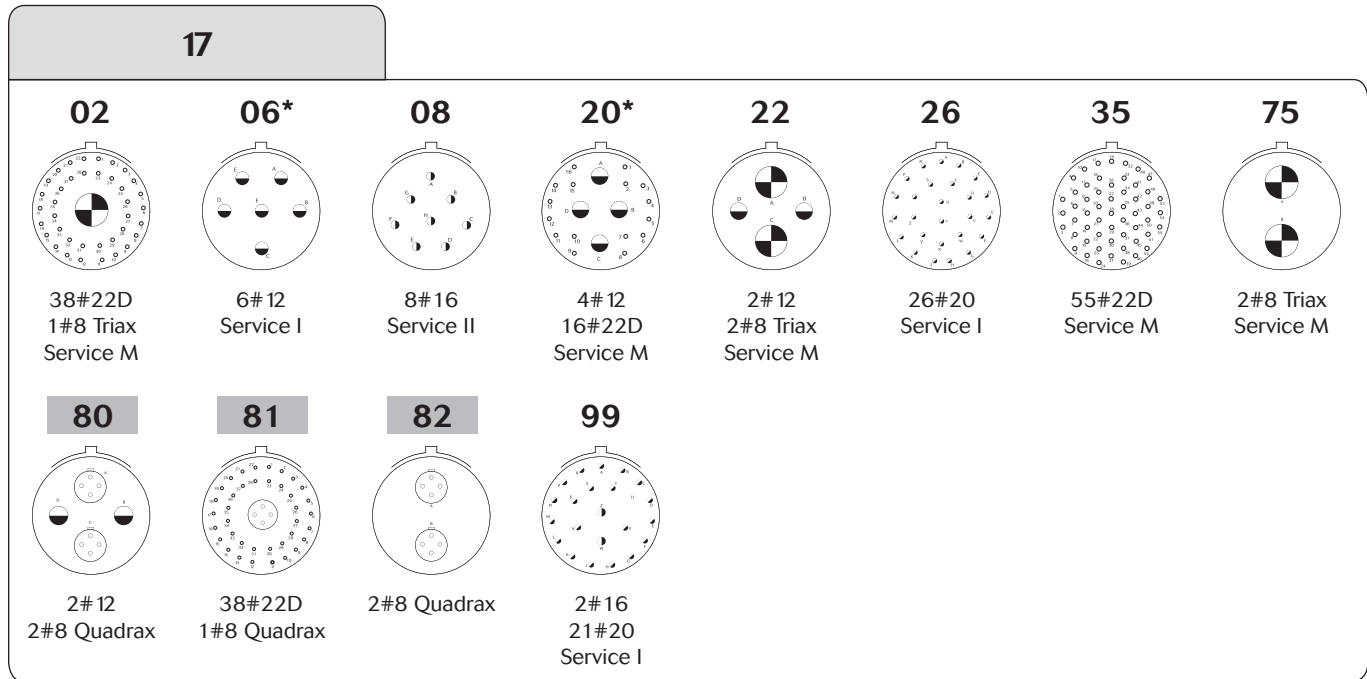
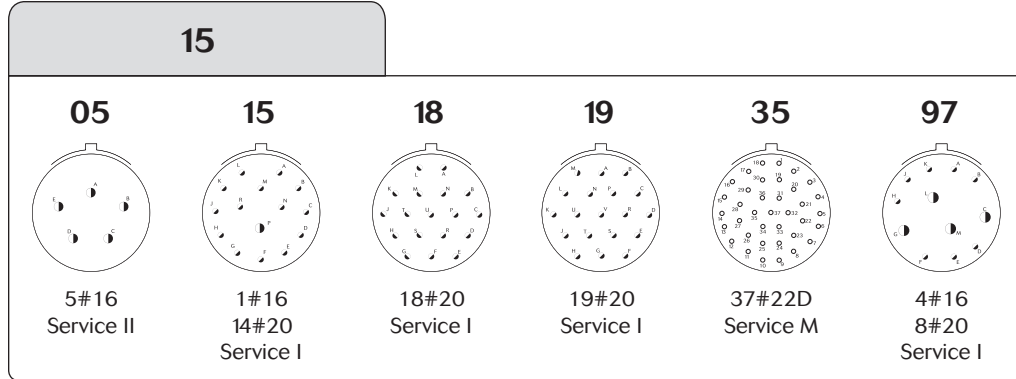

# 8LT Series

## MIL-DTL-38999 Series I



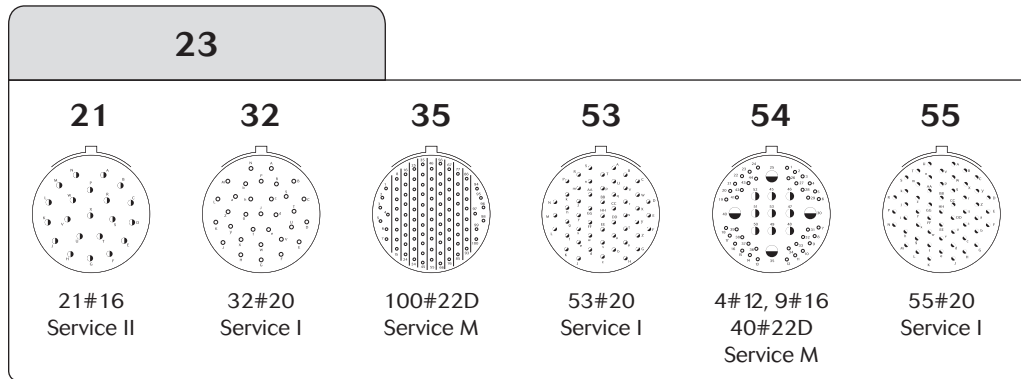
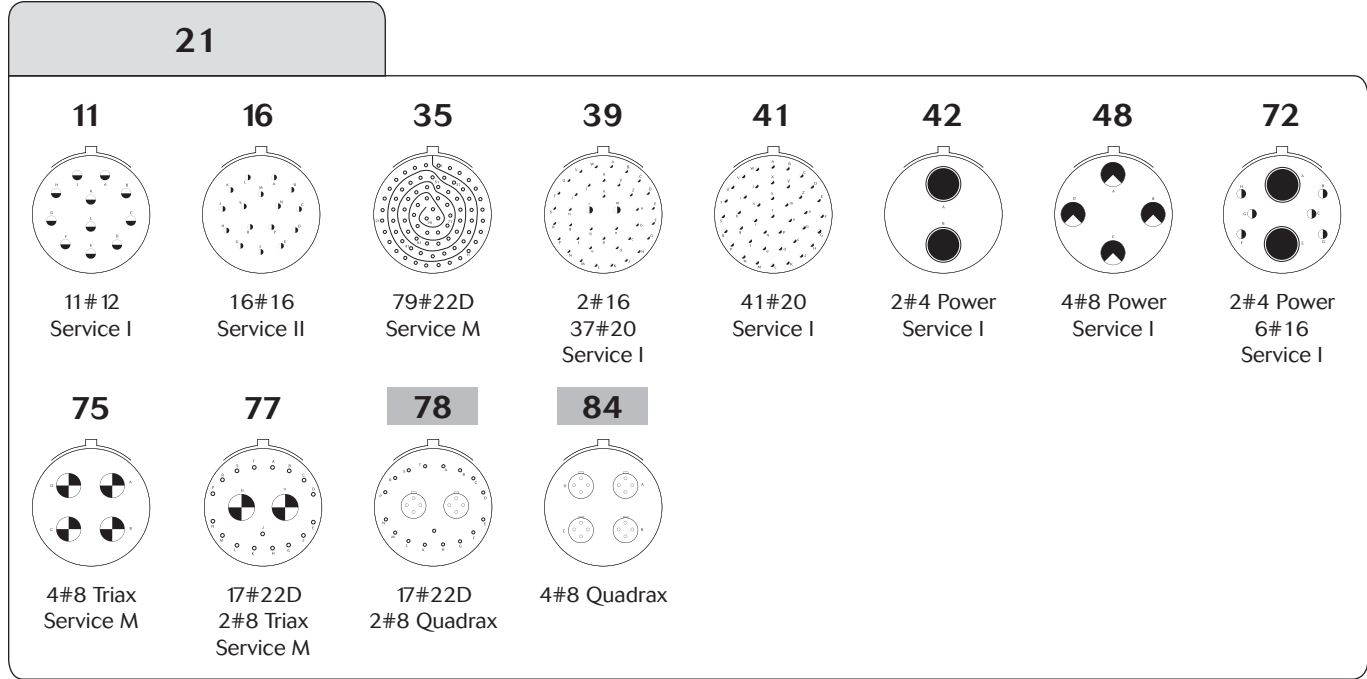

### Contact layouts

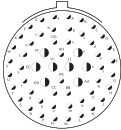
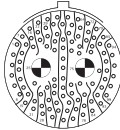
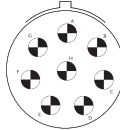
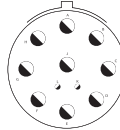
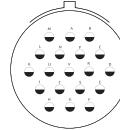
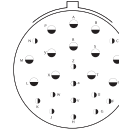
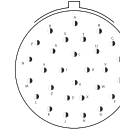
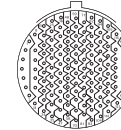
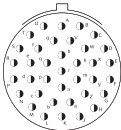
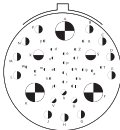
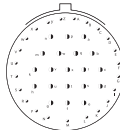

# 8LT Series

## MIL-DTL-38999 Series I

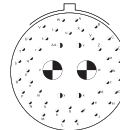
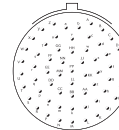
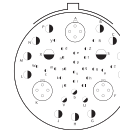
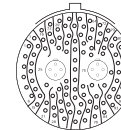
### Contact layouts

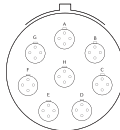
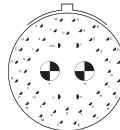
25							
<p><b>04</b></p>  <p>8#16 48#20 Service I</p>	<p><b>07</b></p>  <p>2#8 Triax 97#22D Service M</p>	<p><b>08*</b></p>  <p>8#8 Triax Service M</p>	<p><b>11*</b></p>  <p>2#20 9#10 Service N</p>	<p><b>19</b></p>  <p>19#12 Service I</p>	<p><b>24</b></p>  <p>12#16 12#12 Service I</p>	<p><b>29</b></p>  <p>29#16 Service I</p>	<p><b>35</b></p>  <p>128#22D Service M</p>
<p><b>37</b></p>  <p>37#16 Service I</p>	<p><b>41</b></p>  <p>22#22D, 3#20 11#16, 2#12 3#8 Triax Service M</p>	<p><b>43</b></p>  <p>23#20 20#16 Service I</p>	<p><b>44</b></p>  <p>4#4 Power 4#16 Service I</p>	<p><b>46</b></p>  <p>40#20, 4#16 2#8 Coax Service M</p>	<p><b>61</b></p>  <p>61#20 Service I</p>	<p><b>81</b></p>  <p>22#22D 3#20, 11#16 2#12 3#8 Quadrax</p>	<p><b>82</b></p>  <p>97#22D 2#8 Quadrax</p>
<p><b>86</b></p>  <p>40#20 4#16 2#8 Quadrax</p>	<p><b>88</b></p>  <p>8#8 Quadrax</p>	<p><b>90</b></p>  <p>40#20, 4#16 2#8 Twinax Service I</p>					



# 8LT Series

## MIL-DTL-38999 Series I

### Contact layouts (matrix)

Shell Size	Layout	Service	8LT	8LT2	MIL-DTL-38999 (QPL)		HE 308			Nber of Contacts	#26	#22D	#20	#16	#12	#10	#8	#4 Power
					MS (1)	MS27505	Not Rack		Rack									
09	09-12	R	✓							12	12							
	09-35	M	✓	✓	Q	Q	O	X		6	6							
	09-98	I	✓	✓	Q		O	X		3		3						
11	11-01	II	✓						•	1					1			
	11-02	I	✓		Q				•	2			2					
	11-04	I	✓		Q				•	4		4						
	11-05	I	✓		Q				•	5		5						
	11-22	M	✓							4	4							
	11-26	R	✓							26	26							
	11-35	M	✓	✓	Q	Q	O	X	•	13		13						
	11-80	I	✓							1							1 Triax	
	11-81	-	✓							1							1 Qdx	
	11-98	I	✓	✓	Q	Q	O	X	•	6		6						
	11-99	I	✓	✓	Q				•	7		7						
13	13-03	I	✓	✓						3			3					
	13-04	I	✓		Q		O		•	4			4					
	13-08	I	✓		Q				•	8		8						
	13-26	M	✓							8	6				2			
	13-35	M	✓	✓	Q	Q	O	X	•	22		22						
	13-43	R	✓							43	43							
	13-98	I	✓	✓	Q	Q	O	X	•	10			10					
15	15-05	II	✓		Q		O	X	•	5			5					
	15-15	I	✓						•	15		14	1					
	15-18	I	✓	✓	Q	Q	O		•	18		18						
	15-19	I	✓	✓	Q	Q	O	X	•	19		19						
	15-35	M	✓	✓	Q	Q	O	X	•	37		37						
	15-97	I	✓	✓	Q	Q	O	X	•	12			8	4				
17	17-02	M	✓							39		38					1 Triax	
	17-06	I	✓	✓	Q	Q	O		•	6		6						
	17-08	II	✓		Q		O	X	•	8			8					
	17-20	M	✓							20	16				4			
	17-22	M	✓							4					2		2 Triax	
	17-26	I	✓	✓	Q	Q	O	X	•	26		26						
	17-35	M	✓	✓	Q	Q	O	X	•	55		55						
	17-75	M	✓						•	2							2 Triax	
	17-80	-	✓							4					2		2 Qdx	
	17-81	-	✓							39		38					1 Qdx	
	17-82	-	✓							2							2 Qdx	
17-99	I	✓	✓	Q	Q	O	X	•	23			21	2					
19	19-11	II	✓		Q		O	X	•	11			11					
	19-18	M	✓							18	14						4 Triax	
	19-28	I	✓	✓	Q				•	28		26	2					
	19-32	I	✓	✓	Q	Q	O	X	•	32		32						
	19-35	M	✓	✓	Q	Q	O	X	•	66		66						
	19-84	-	✓							18		14					4 Qdx	

- ✓ Souriau's layout
- Q Qualified layout (QPL) MIL - DTL 38999
- (1) Available MS27466 & MS27467 & MS27468 & MS27656
- O Layout according to UTE C 93-422 norm
- X Qualified Layout HE308 for «Ministère de la Défense» DGA DTAT
- Layout according to C5935X0005 norm
- #8 Qdx: Quadrax



# 8LT Series

## MIL-DTL-38999 Series I

### Contact layouts (matrix)

Shell Size	Layout	Service	8LT	8LT2	MIL-DTL-38999 (QPL)		HE 308			Nber of Contacts	#26	#22D	#20	#16	#12	#10	# 8	#4 Power
					MS (1)	MS27505	Not Rack		Rack									
21	21-11	I	✓		Q		O	X	•	11					11			
	21-16	II	✓	✓	Q	Q	O	X	•	16			16					
	21-35	M	✓	✓	Q	Q	O	X	•	79	79							
	21-39	I	✓	✓	Q	Q	O		•	39		37	2					
	21-41	I	✓	✓	Q	Q	O	X	•	41		41						
	21-42	I	✓							2								2
	21-48	I	✓							4							4 Pow	
	21-72	I	✓							8				6				2
	21-75	-	✓			Q			•	4							4 Triax	
	21-77	M	✓							19		17					2 Triax	
	21-78	-	✓							19		17					2 Qdx	
21-84	-	✓							4							4 Qdx		
23	23-21	II	✓		Q		O		•	21			21					
	23-32	I	✓	✓	Q	Q				32		32						
	23-35	M	✓	✓	Q	Q	O	X	•	100	100							
	23-53	I	✓		Q		O	X	•	53		53						
	23-54	M	✓							53		40		9	4			
	23-55	I	✓			Q			•	55			55					
25	25-04	I	✓		Q	Q				56			48	8				
	25-07	M	✓		Q					99		97					2 Triax	
	25-08	-	✓							8							8 Triax	
	25-11	N	✓							11		2			9			
	25-19	I	✓		Q		O	X		19				19				
	25-24	II	✓		Q					24			12	12				
	25-29	I	✓		Q		O	X		29			29					
	25-35	M	✓	✓	Q	Q	O	X		128	128							
	25-37	I	✓							37			37					
	25-41	N	✓							41		22	3	11	2		3 Triax	
	25-43	I	✓			Q				43			23	20				
	25-44	I	✓							8				4				4
	25-46	I	✓			Q				46			40	4			2 Coax	
	25-61	I	✓			Q		O	X	61			61					
	25-81	N	✓							41		22	3	11	2		3 Qdx	
25-82	M	✓							99		97					2 Qdx		
25-86	I	✓							46			40	4			2 Qdx		
25-88	-	✓							8							8 Qdx		
25-90	I	✓							46			40	4			2 Triax		

- ✓ Souriau's layout
- Q Qualified layout (QPL) MIL - DTL 38999
- (1) Available MS27466 & MS27467 & MS27468 & MS27656
- O Layout according to UTE C 93-422 norm
- X Qualified Layout HE308 for «Ministère de la Défense» DGA DTAT
- Layout according to C5935X0005 norm
- #8 Pow: Power; Qdx: Quadrax

8  
BIT  
Series.



## 8LT Series

# Series

■ 8LT Standard Version .....	16
■ Backshells .....	24
■ 8LT Rack & Panel .....	28
■ 8LT Resin Sealed .....	32



# 8LT Series

## MIL-DTL-38999 Series I



## Description

- High contact density
- Bayonet coupling
- Contact protection : 100% Scoop proof
- Shell size from 9 to 25
- Accessories available (protective caps, backshells, etc...)
- RFI - EMI shielding and shell to shell continuity
- Hermetic
- Aluminum alloy, protection by cadmium, nickel, green zinc cobalt or black zinc nickel plating

## Applications

- Civil and Military Aerospace
- Marine Equipments
- Communications Equipments
- Medical Instrumentation
- Ballistic Missiles & Weapon Systems
- Armored Carriers & Tanks
- Test Equipments

## Technical features

### Mechanical

- Shell: aluminum alloy
- Plating:
  - . black zinc nickel (Z)
  - . olive green cadmium (B)
  - . nickel (F)
  - . green zinc cobalt (ZC)
- Insulator: thermoplastic or metallic version available for specification 284 & 384
- Grommet or seal: liquid silicone rubber or fluorocarbene elastomer for specification 022
- Contact: copper alloy
- Plating contact: gold over nickel
- Endurance: 500 mating / unmating operations

- Shock: 300 g during 3 ms and as per MIL S 901 grade A
- Vibration:
  - . Sine 10 to 2000 Hz - 30 g
  - . Random 100 à 300 Hz - 5 g<sup>2</sup>/Hz
- Contact retention (min force in N):

Contacts size	22	20	16	12	8	4
Min force in N	44	67	111	111	111	200

### Electrical

- Test voltage (Vrms)

Service	sea level	at 21000 m
R	400	N/A
M	1 300	800
N	1 000	600
I	1 800	1 000
II	2 300	1 000

- Insulation resistance:  $\geq 5\,000\text{ M}\Omega$  (at 500 Vdc)

- Contact resistance:

Contacts size	26	22	20	16	12	8	4
Resistance m $\Omega$	16	14.6	7.3	3.8	3.5	3	2

- Contact rating:

Contacts size	26	22	20	16	12	8	4
Rating (A)	3	5	7.5	13	23	45	80

- Shell continuity:
  - . black zinc nickel: 2.5 m $\Omega$
  - . olive green plating: 2.5 m $\Omega$
  - . nickel plating: 1 m $\Omega$
  - . green zinc cobalt: 2.5 m $\Omega$

- Shielding: 90 db at 100 MHz, 50 db at 10 000 MHz
- Electrical continuity between contact and shell for specification 284 & 384: 10 m $\Omega$  max

### Climatic

- Temperature range:
  - . black zinc nickel plating (Z)
    - 65°C +175°C
  - . olive green cadmium plating (B)
    - 65°C +175°C
  - . nickel plating (F)
    - 65°C +200°C
  - . green zinc cobalt plating (ZC)
    - 65°C +200°C
- Sealing: mated connectors  
Differential pressure 2 bars:  
leakage  $\leq 16\text{ cm}^3/\text{h}$
- Salt spray as per:
  - . MIL STD 1344 method 1001 :
    - 500 hours (plating B, ZC and Z)
    - 48 hours (plating F)
  - . NFC 93422 :
    - 48 hours (plating F)
- Resistance to fluids
  - . As per MIL DTL 38999, hydraulic fluids, solvents
  - . Specification 022 for fuel immersion (please consult us)

# 8LT Series

## MIL-DTL-38999 Series I

### Ordering information

Basic series	8LT	0	-	13	B	35	P	N			L
<b>Shell type</b>											
0: Square flange receptacle											
1: In line receptacle											
2: Short square flange receptacle, not accepting backshell											
3: Square flange receptacle (rear mounting)											
5: Plug with RFI shielding											
7: Jam nut receptacle											
15: Plug with RFI shielding, not accepting backshell											
<b>Type</b>											
-: Connector with standard crimp contacts											
L: Connector with long PC tail (male and female #22D)											
M: Connector with medium PC tail (please see page 38)											
C: Connector with short PC tail (male and female #22D, #20, #16, #12, #8 quadrax)											
T: Connector with male contact size 20 for wire wrap (2 wraps)											
W: Connector with male contact size 22D for wire wrap (3 wraps)											
S: Connector with specific PC Tail (male and female #22D only)											
Q: Connector with quadrax crimp contacts											
P: Connector with solder cup: . Pin: #22D & #16; Socket: #12 . Socket: #22D & #16; Pin: #12 - Please consult us											
<b>Shell size</b>											
09; 11; 13; 15; 17; 19; 21; 23; 25											
<b>Plating</b>											
Z: Black zinc nickel											
F: Nickel											
B: Olive green cadmium											
ZC: Green zinc cobalt											
<b>Contact layout</b>											
See tables pages 8 to 11											
<b>Contact type</b>											
P: Male											
A: Connector supplied less pin contact or with specific contacts (Connector marking : A + orientation)											
S: Female											
B: Connector supplied less socket contact or with specific contacts (Connector marking : B + orientation)											
<b>Orientation <sup>(1)</sup></b>											
N, A, B, C, D see table page 48											
<b>Specifications</b>											
None: Supplied with contact											
046: PC Tail contact with tinned plating											
251: Connector provided with power contacts with layout contacts #8											
022: Fuel tank Please consult us											
284: Quadrax grounded PC tail contact, type L, C & S only (100Ω) <sup>(2)(3)</sup>											
308: Quadrax not grounded PC tail contact, type L, C & S only (100Ω) <sup>(2)</sup>											
620: Quadrax grounded crimp contact, type Q only (100Ω) <sup>(2)(3)</sup>											
621: Quadrax not grounded crimp contact, type Q only (100Ω) <sup>(2)</sup>											
384: Quadrax grounded crimp contact, type Q only (150Ω) <sup>(2)(3)</sup>											
408: Quadrax not grounded crimp contact, type Q only (150Ω) <sup>(2)</sup>											
<b>Special custom</b>											
None: Standard plastic cap											
M: Antistatic plastic cap											
L: For P or S contact type only, connector delivered without contacts, connector marking P or S (without L)											

(1) Orientations B & C not developed for shell size number 9.

(2) Type shell 0, 3 and 5 available only.

(3) Excepted mixed layouts with quadrax and signal contacts. Please consult us.

# 8LT Series

## MIL-DTL-38999 Series I

### MIL-DTL-38999 connector part numbers

<b>Basic series</b>	MS	27466	T	13	B	35	P			L
<b>Shell type</b>										
27466: Square flange receptacle (front mounting)										
27656: Square flange receptacle (rear mounting)										
27468: Jam nut receptacle										
27467: Plug with RFI shielding										
27505: Square flange receptacle, not accepting backshell										
<b>Class</b>										
E: Without thread for back fitting, not accepting backshell for MS27505 and MS27467 only										
T: With thread for backfitting, supplied without backshell (excepted MS27505)										
<b>Shell size</b>										
09; 11; 13; 15; 17; 19; 21; 23; 25										
<b>Plating</b>										
Z: Black zinc nickel    F: Nickel    B: Olive green cadmium										
<b>Contact layout</b>										
See tables pages 8 to 11										
<b>Contact type</b>										
P: Male    A: Connector supplied less pin contact or with specific contacts (Connector marking : A + orientation)										
S: Female    B: Connector supplied less socket contact or with specific contacts (Connector marking : B + orientation)										
<b>Orientation (1)</b>										
None: Normal (N)										
A, B, C, D see table page 48										
<b>Special custom</b>										
None: Standard plastic cap										
M: Antistatic plastic cap										
L: For P or S contact type only, connector delivered without contacts, connector marking P or S (without L)										

### HE 308 connector part numbers

<b>Basic series</b>	HE308	00	T	13	35	P	N	7	M	L
<b>Shell type</b>										
00: Square flange receptacle										
07: Jam nut receptacle										
06: Plug with RFI shielding										
11: Jam nut receptacle with PC Tail contacts										
<b>Class</b>										
T: Sealed										
<b>Shell size</b>										
09; 11; 13; 15; 17; 19; 21; 23; 25										
<b>Contact layout</b>										
See tables pages 8 to 11										
<b>Contact type</b>										
P: Male										
S: Female										
<b>Orientation (1)</b>										
N, A, B, C, D see table page 48										
<b>Plating</b>										
6: Nickel										
7: Olive green cadmium										
<b>Contractual specification</b>										
<b>Special custom</b>										
None: Standard plastic cap										
M: Antistatic plastic cap										
<b>Specification</b>										
None: Connector supplied with contact										
L: Connector supplied without contact										

(1) Orientations B & C not developed for shell size number 9.

# 8LT Series

## MIL-DTL-38999 Series I

### Dimensions

#### Type 0 - Square flange receptacle

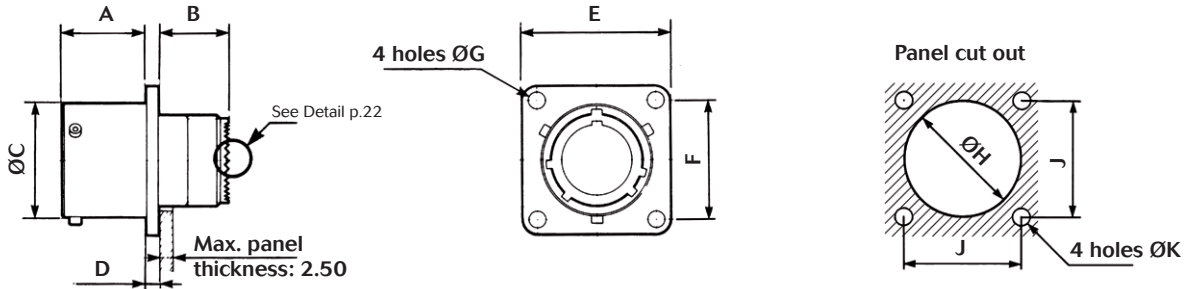

Shell size	A		B		ØC		D		E		F	ØG		ØH Min	J	K <sup>±0.15</sup>
	Min	Max	Min	Max	Min	Max	Min	Max	Min	Max		Min	Max			
09	15.93	16.05	13.23	13.49	14.40	14.53	2.14	2.54	23.70	24.30	18.26	3.25	3.35	15.70	18.26	3.25
11					17.65	17.78			26.05	26.70	20.62					
13					21.40	21.59			28.50	29.05	23.01					
15					24.65	24.77			30.85	31.45	24.61					
17					27.82	27.94			33.20	33.80	26.97					
19					29.24	30.66			36.40	37.00	29.36					
21	15.17	15.29	13.23	13.49	33.70	33.83	2.90	3.30	39.55	40.15	31.75	3.73	3.83	34.20	31.75	3.91
23					36.92	37.00			42.75	43.35	34.93					
25					40.06	40.18			46.00	46.50	38.10					

#### Type 1 - Cable connecting receptacle

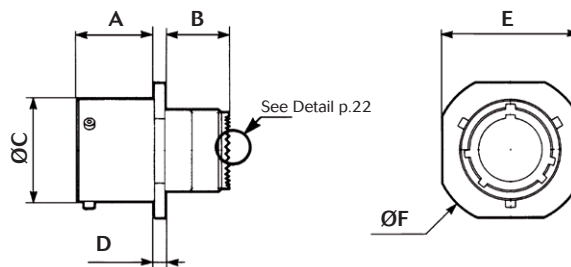

Shell size	A		B		ØC		D		E		ØF	
	Min	Max	Min	Max	Min	Max	Min	Max	Min	Max	Min	Max
9	15.93	16.05	13.23	13.49	14.40	14.53	2.14	2.54	18.35	18.92	21.80	22.35
11					17.65	17.78			21.65	22.22	25.10	25.65
13					21.40	21.59			25.05	25.62	28.50	29.05
15					24.65	24.77			27.25	27.82	30.70	31.25
17					27.82	27.94			30.78	31.35	34.10	34.65
19					29.24	30.66			34.05	34.62	37.50	38.05
21	15.17	15.29	13.23	13.49	33.70	33.83	2.90	3.30	37.45	38.02	40.90	41.45
23					36.92	37.00			41.45	42.02	44.90	45.45
25					40.06	40.18			45.93	46.50	49.40	49.95

Note: All dimensions are in millimeters (mm)

# 8LT Series

## MIL-DTL-38999 Series I

### Type 3 - Square flange receptacle (rear mounting)

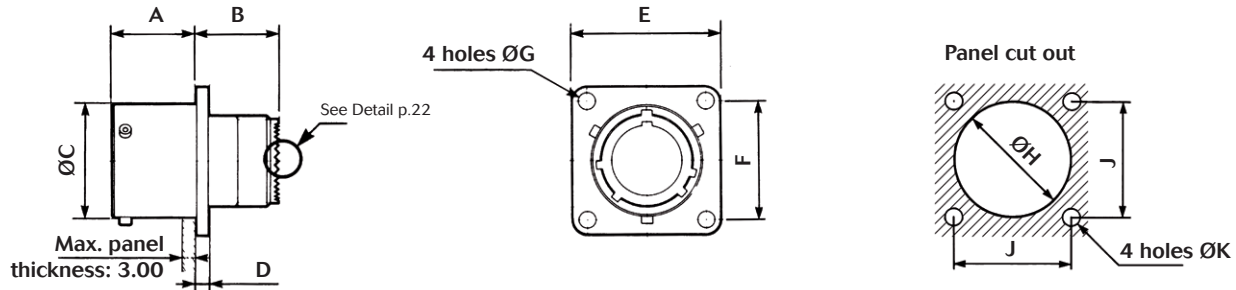

Shell size	A		B		ØC		D		E		F	ØG		ØH Min	J	K <sup>±0.15</sup>
	Min	Max	Min	Max	Min	Max	Min	Max	Min	Max		Min	Max			
09	20.71	20.83	10.40	11.90	14.40	14.53	2.14	2.54	23.70	24.30	18.26	3.25	3.35	16.66	18.26	3.25
11					17.65	17.78			26.05	26.70	20.62			20.22	20.62	
13					21.40	21.59			28.50	29.05	23.01			23.42	23.01	
15					24.65	24.77			30.85	31.45	24.61			26.59	24.61	
17					27.82	27.94			33.20	33.8	26.97			30.96	26.97	
19					29.24	30.66			36.40	37.00	29.36			32.94	29.36	
21	19.96	20.08	11.15	12.70	33.70	33.83	2.90	3.30	39.55	40.15	31.75	3.73	3.83	36.12	31.75	3.91
23					36.92	37.00			42.75	43.35	34.93			39.29	34.92	
25					40.06	40.18			46.00	46.50	38.10			42.47	38.10	

### Type 7 - Jam nut receptacle Type 11 - HE 308

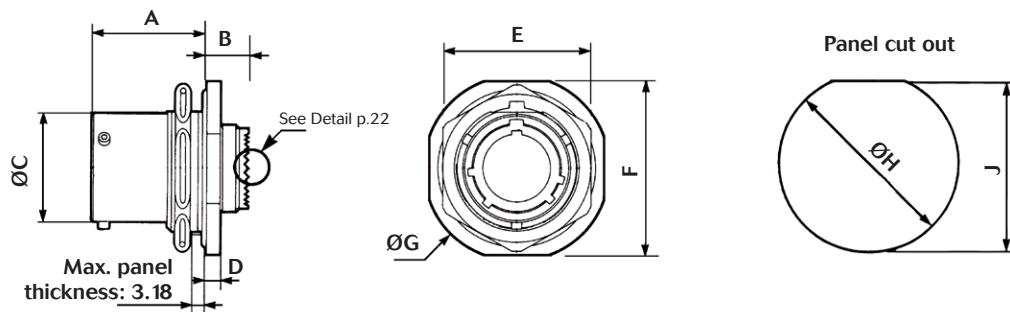

Shell size	F		E		ØC		ØG		A		B		D		ØH	J
	Min	Max	Min	Max	Min	Max	Min	Max	Min	Max	Min	Max	Min	Max		
09	26.60	27.35	21.95	22.35	14.40	14.53	29.90	30.58	23.12	23.36	8.18	8.32	2.60	3.00	17.78	17.02
11	31.40	32.10	25.15	25.55	17.65	17.78	34.60	35.30							20.96	19.59
13	34.60	35.31	29.80	30.30	21.40	21.59	37.75	38.50							25.65	24.26
15	37.80	38.49	33.05	33.45	24.65	24.77	41.00	41.65							28.83	27.56
17	40.90	41.63	36.25	36.65	27.82	27.94	44.11	44.85							32.00	30.73
19	45.63	46.37	39.40	39.80	29.24	30.66	48.90	49.60							35.18	33.91
21	48.84	49.58	42.60	43.00	33.70	33.83	52.00	52.75	3.35	3.79	38.35	37.08				
23	52.02	52.76	45.75	46.15	36.92	37.00	55.30	55.94			41.53	40.26				
25	55.19	55.93	50.65	50.95	40.06	40.18	58.40	59.10			44.70	43.45				

Note: All dimensions are in millimeters (mm)



# 8LT Series

## MIL-DTL-38999 Series I

### Type 2 - Short square flange receptacle (not accepting backshell)

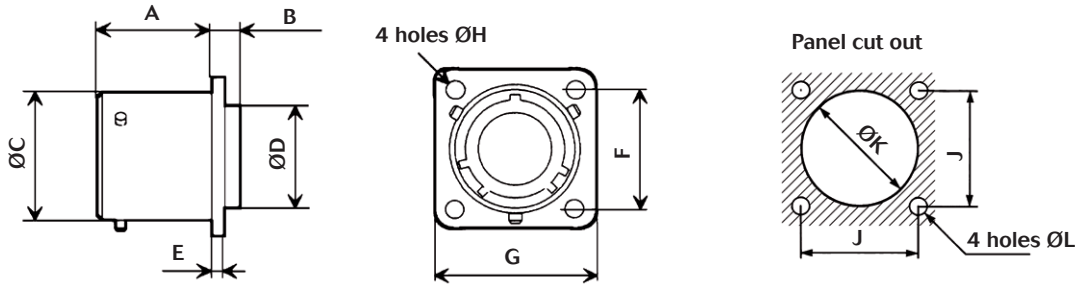

Shell size	A		B		ØC		ØD		E		F	G		ØH		J	ØK	ØL
	Min	Max	Min	Max	Min	Max	Min	Max	Min	Max		Min	Max	Min	Max			
09	20.71	20.83	5.40	5.55	14.40	14.53	9.85	9.95	2.14	2.54	18.26	23.70	24.30	3.25	3.35	18.26	16.66	3.25
11					17.65	17.78	12.80	12.90			20.62	26.05	26.70			20.62	20.22	
13					21.40	21.59	16.00	16.10			23.01	28.50	29.05			23.01	23.42	
15					24.65	24.77	18.95	19.05			24.61	30.85	31.45			24.61	26.59	
17					27.82	27.94	22.10	22.20			26.97	33.20	33.80			26.97	30.96	
19					29.24	30.66	25.10	25.20			29.36	36.40	37.00			29.36	32.94	
21	19.96	20.08	6.15	6.35	33.70	33.83	28.25	28.35	2.90	3.30	31.75	39.55	40.15	3.73	3.83	31.75	36.12	3.91
23					36.92	37.00	31.40	31.50			34.93	42.75	43.35			34.92	39.29	
25					40.06	40.18	34.60	34.70			38.10	46.00	46.50			38.10	42.47	

### Type 5 - Plug with RFI shielding Type 15 - Plug with RFI shielding (not accepting backshell)

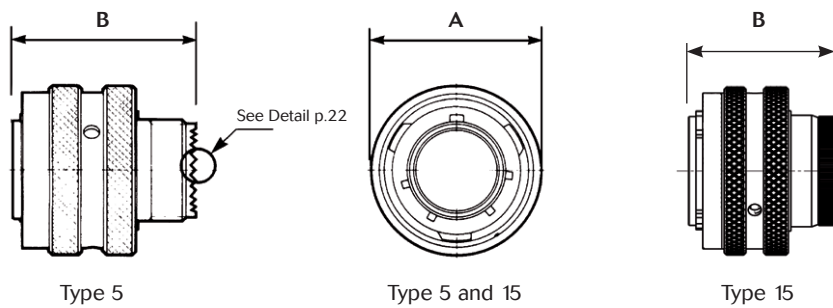

Shell size		09	11	13	15	17	19	21	23	25
A	Max	21.80	25.00	29.30	32.50	35.70	38.50	41.70	43.85	48.00
	Min	31.28	31.28	31.28	31.28	31.28	31.28	31.28	31.28	31.28
B	Max	31.35	31.35	31.35	31.35	31.35	31.35	31.35	31.35	31.35

# 8LT Series

## MIL-DTL-38999 Series I

### Detail

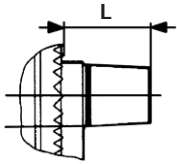

Sealing bushing  
used for triaxial  
#8 protude

Shell Type	Type 0	Type 1	Type 3	Type 5	Type 7
L max	13.39	13.58	13.58	13.54	13.58

### Mated connectors dimensions

Square flange receptacle (type 0)  
with plug (type 5)

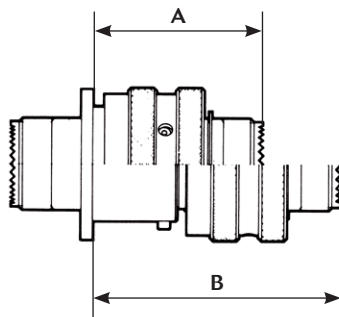

Jam nut receptacle (type 7)  
with plug (type 5)

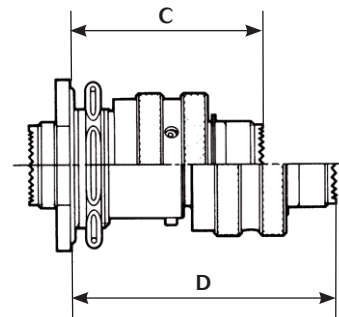

Shell Size	A Max	B Max	C Max	D Max
09	33.30	47.40	40.60	54.70
11				
13				
15				
17				
19	32.50	46.70	40.60	54.70
21				
23				
25				

Note: All dimensions are in millimeters (mm)

# 8LT Series

## MIL-DTL-38999 Series I

### Receptacle with PC Tail contact

Type 0  
Square flange receptacle

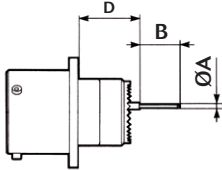

Type 2  
Short square flange receptacle

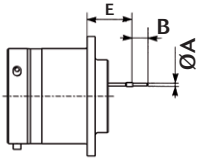

Type 3  
Square flange receptacle (rear mounting)

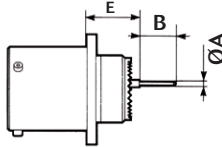

Type 7  
Jam nut receptacle

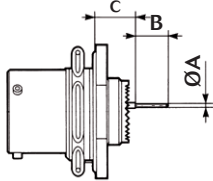

(1) M: Male Contact  
F: Female Contact

(2) C: Short PC tail  
M: Medium PC tail  
L: Long PC tail  
S: Specific PC tail

Shell Size				09	11	13	15	17	19	21	23	25	
	Contact size	Contact type (1)	PC tail contact (2)										
ØA	#22D	M & F	C & L	0.70									
			S	0.50									
	#20	M & F	C	0.70									
	#16	M & F	C	1.15									
B	#22D	M & F	C	4 <sup>0</sup> <sub>-0.20</sub>									
			S	5 <sup>±0.1</sup>									
			L	8.5 <sup>0</sup> <sub>-0.20</sub>									
	#20	M & F	C	5 <sup>±0.1</sup>									
#16	M & F	C	5 <sup>±0.1</sup>										
C type 7	8LT #22D	M	C & L	Max	10.06							15.25	
			Min	9.07							14.08		
		M	Max	10.21							15.25		
		Min	9.23							14.08			
	F	C & L	Max	10.06							15.25		
		Min	8.74							14.08			
	8LT7S HE308 #22D	M	S	Max	10.23							15.25	
		Min	9.24							14.08			
8LT/HE308 #20 & #16	M & F	C	Max	10.23							15.25		
			Min	9.24							14.08		
D type 0	#22D	M	C & L	Max	15.08							15.25	
			Min	13.91							14.08		
		M	Max	15.22							15.25		
		Min	14.05							14.08			
	F	C & L	Max	15.08							15.25		
		Min	13.58							14.08			
	M	S	Max	15.25	-							15.25	
			Min	14.08	-							14.08	
	F	S	Max	15.25	-							15.25	
			Min	13.75	-							13.75	
#20 & #16	M & F	C	Max	15.25							15.25		
			Min	14.08							14.08		
E type 2 type 3	#22D	M	C & L	Max	12.47				13.22				
			Min	11.60				12.35					
		F	C & L	Max	12.47				13.22				
		Min	11.27				12.02						
	M	S	Max	12.64	-				12.64	13.39			
			Min	11.77	-				11.77	12.52			
	F	S	Max	12.64	-				12.64	13.39			
			Min	11.44	-				11.44	12.19			
#20 & #16	M & F	C	Max	12.64				13.39					
			Min	11.77				12.52					

### Type 7 receptacle with wire wrap contacts

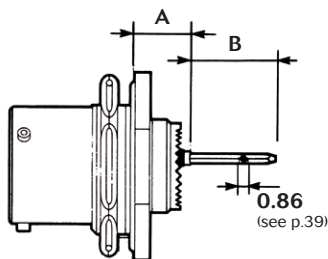

Contact size	Contact type	A	B Max
#22D	W (3 wraps)	9.07 / 10.06	16.00
#20	T (2 wraps)	9.7 / 10.06	12.60

Note: All dimensions are in millimeters (mm)

# 8LT Series

## MIL-DTL-38999 Series I

### Aluminum backshells

#### Ordering information

Basic Series	8T	AB	05	A	16	W	S	01	-																				
Accessories type																													
Type:																													
01: Backnut	04: Crimp ring																												
02: Cable clamp	05: Band lock																												
03: Shrink boot	06: Double cone																												
Angle:																													
A: Straight																													
B: 90° (Type 02 only)																													
Size code:	<table border="1"> <tr> <td>Size code</td> <td>08</td><td>10</td><td>12</td><td>14</td><td>16</td><td>18</td><td>20</td><td>22</td><td>24</td> </tr> <tr> <td>= Shell size 8LT</td> <td>09</td><td>11</td><td>13</td><td>15</td><td>17</td><td>19</td><td>21</td><td>23</td><td>25</td> </tr> </table>									Size code	08	10	12	14	16	18	20	22	24	= Shell size 8LT	09	11	13	15	17	19	21	23	25
Size code	08	10	12	14	16	18	20	22	24																				
= Shell size 8LT	09	11	13	15	17	19	21	23	25																				
Finish:																													
Z: Black zinc nickel																													
W: Olive green cadmium																													
F: Nickel																													
A: Black anodized																													
Self locking option:																													
None																													
S: Self locking (available for Types 01 & 02 - mandatory for Type 05)																													
Cable entry (Type 05 only):																													
01, 02 (02 mandatory for shell size 08 & 10)																													
Drain hole option:																													
None																													
D: Drain hole (Type 03 only)																													

#### Dimensions

### Aluminum backshell Type 01 - Backnut

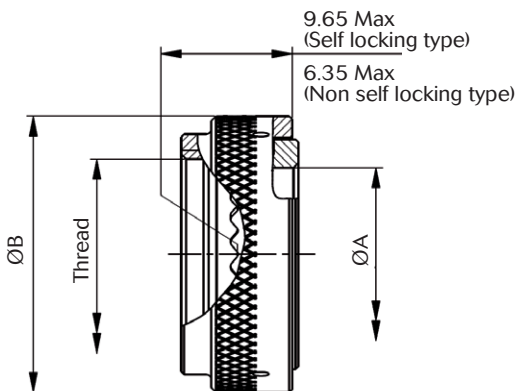

Shell size	ØA Min	ØB Max
09	6.7	17.9
11	9.95	20.9
13	12.85	24.3
15	17.0	27.9
17	19.25	31.3
19	21.7	35.3
21	24.7	38.1
23	27.8	41.5
25	32.0	44.5

Thread: See page 27 for information.

Note: All dimensions are in millimeters (mm)

# 8LT Series

## MIL-DTL-38999 Series I

### Aluminum backshell Type 02 - Cable clamp

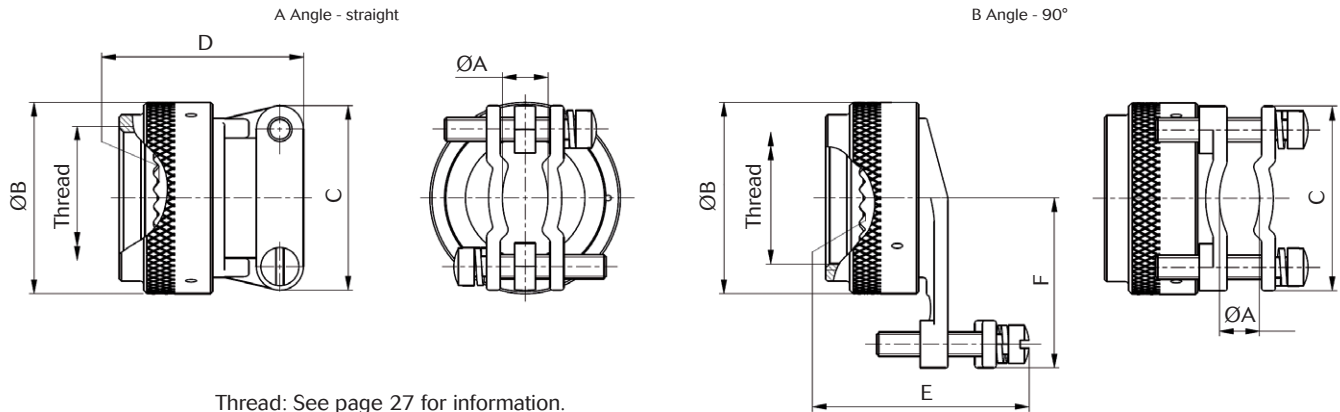

Shell size	ØA		ØB Max	C Max	D Max	E Max	F Max
	Min	Max					
09	2.49	5.94	17.9	21.5	23.1	29.5	20
11	3.89	5.94	20.9	21.5	23.1	29.5	21.5
13	4.83	8.33	24.3	24.5	25.6	31.5	23.5
15	6.60	11.61	27.9	27.5	26.9	35.8	25.5
17	7.19	15.6	31.3	31.5	29.4	40.1	27.5
19	8.26	16.1	35.3	35.5	35.8	40.6	30.5
21	8.71	17.73	38.1	37	38.3	42.7	31.5
23	9.68	20.9	41.5	40.5	42.1	46.2	34.5
25	10.62	21.67	44.5	45	44.7	49	36.5

### Aluminum backshell Type 03 - Shrink boot

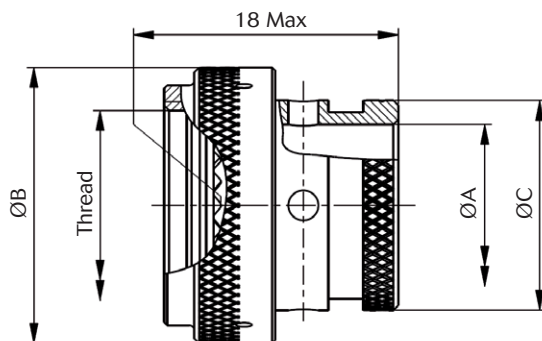

Shell size	ØA Min	ØB Max	C Max
09	6.7	19.0	11.3
11	9.95	21.5	14.9
13	12.85	25.3	17.8
15	16.05	29.1	21.27
17	19.2	31.7	24.3
19	21.5	35.5	26.4
21	24.7	39.3	30.8
23	27.8	41.8	34.1
25	31	46.9	36.6

Thread: See page 27 for information.

# 8LT Series

## MIL-DTL-38999 Series I

### Aluminum backshell Type 04 - Crimp ring

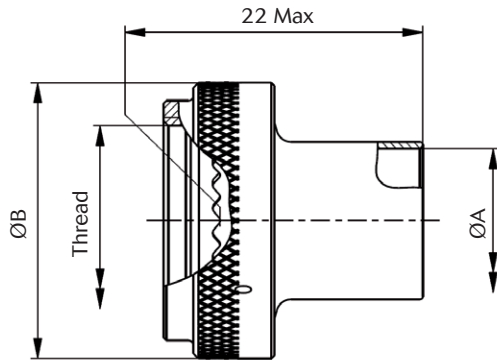

Shell size	ØA Min	ØB Max
09	6	17.9
11	8.2	20.9
13	10.5	24.3
15	13.6	27.9
17	16.9	31.3
19	20	34.3
21	23.2	38.1
23	26.1	41.5
25	28.1	44.4

Thread: See page 27 for information.

### Aluminum backshell Type 05 - Band lock

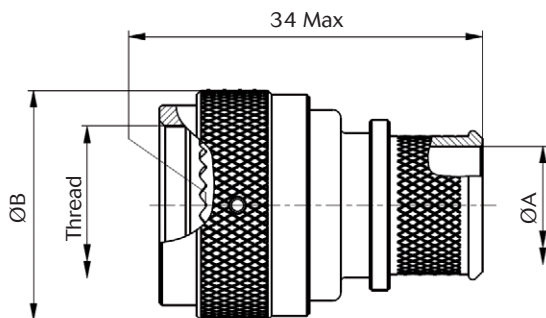

Shell size	ØA Max - Entry size		ØB Max
	01	02	
09	-	6.6	17.9
11	-	8	24.9
13	8	11.2	29.3
15	11.2	14.4	32.4
17	12.8	16	35.6
19	16	19.1	38.4
21	16	20.7	41.6
23	17.6	23.9	44.8
25	19.1	25.5	47.9

Thread: See page 27 for information.

### Aluminum backshell Type 06 - Double cone

HE 308 standard - Screen termination and heat shrink boot

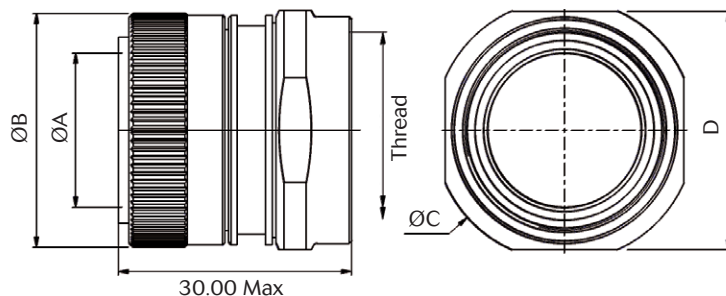

Shell size	ØA <sup>±0.07</sup>	ØB <sup>±0.12</sup>	ØC <sup>±0.12</sup>	D <sup>±0.07</sup>
09	7.1	15.55	19.35	16.7
11	10.25	18.45	23.35	20.7
13	13.05	21.85	25.35	22.7
15	15.25	25.05	28.35	25.7
17	18.45	28.05	31.35	28.7
19	20.65	31.05	34.35	31.7
21	23.85	34.45	38.35	35.7
23	26.95	37.45	41.35	38.7
25	30.15	40.75	44.35	41.7

Thread: See page 27 for information.

# 8LT Series

## MIL-DTL-38999 Series I

### Thread information

Shell size	UNEF Thread
09	7/16-28 2B
11	9/16-24 2B
13	11/16-24 2B
15	13/16-20 2B
17	15/16-20 2B
19	1 1/16 -18 2B
21	1 3/16 -18 2B
23	1 5/16 -18 2B
25	1 7/16 -18 2B

### Recommended installation torque

Shell Size	Installation Torque (Inch-Pounds)
09	40
11	40
13	40
15	40
17	40
19	40
21	80
23	80
25	80

Note: Torque values are based on 80% of the coupling thread strength specified in SAE-AS85049 standard.

### Band-it

Designation	Flat stainless steel standard band	Pre-coiled stainless steel standard band	Hand banding tool
Part number	8599-9344	8599-9345	8599-9346

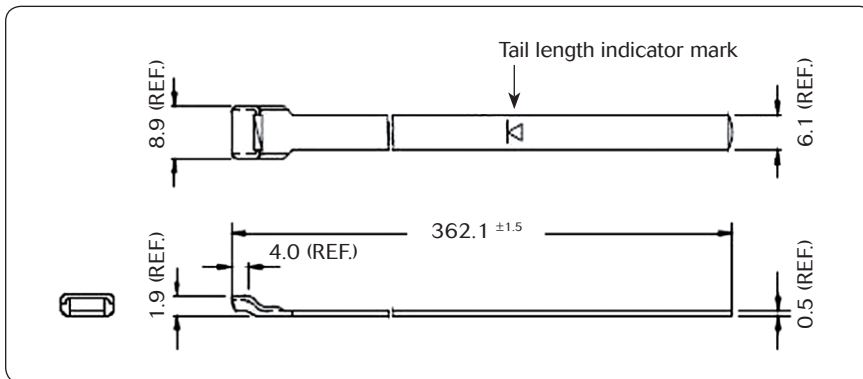

### MIL specification

For aluminum bachshells MIL specification, please consult us.

Note: All dimensions are in millimeters (mm)

# 8LT Series

## MIL-DTL-38999 Series I

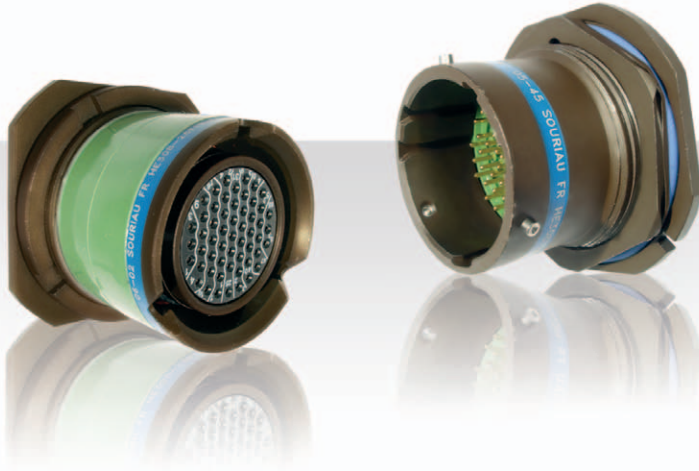

### Rack and Panel

- Signal and Power connector
- Easy and fast connection without any coupling/uncoupling between a float-mounting unit and a fixed unit.
- 100% scoop proof
- Plug misalignment allowed
- Rear accessories available
- 8 shell sizes available: from 11 to 23 with DTAT-C5935-X0005 layout - including power contact cavities
- Sealing as per HE 308
- EMI performances as per DTAT-C5935-X0005

Shell Size	Mated Force (daN)	Unmated Force (daN)
11	20	12
13	30	13
15	35	15
17	50	16
19	55	18
21	65	22
23	80	27
25	-	-

### Blind mateable connector

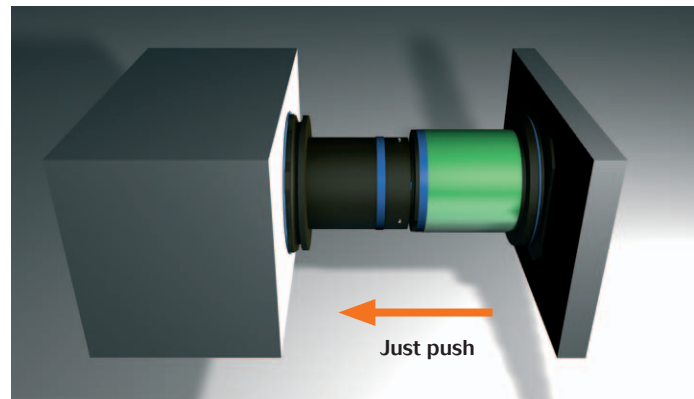

Just push to connect... and release to disconnect

### Superior misalignment allowances

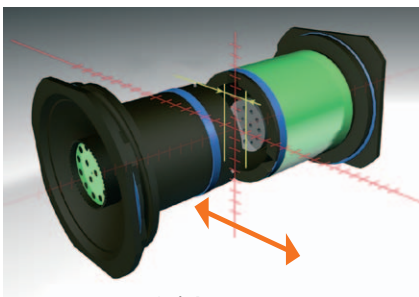

Axial  $\pm 1$  mm

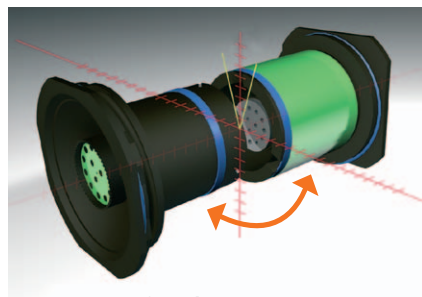

Angular  $\pm 1$  mm

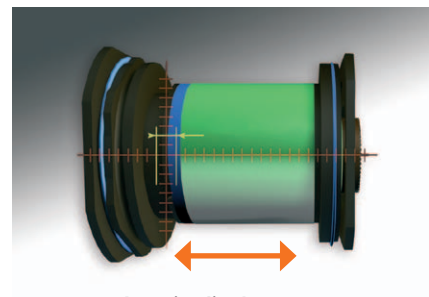

Longitudinal  $\pm 1$  mm



# 8LT Series

## MIL-DTL-38999 Series I

### Rack and Panel - Ordering information

#### SOURIAU Rack and Panel connectors part numbers

<b>Basic series</b>	8LT	27	-	15	B	35	P	N		L
<b>Shell type</b>										
27:	Receptacle for rack, with possibility to mount rear accessory									
23:	Square flange receptacle (consult us)									
26:	Floating plug for rack, with possibility to mount rear accessory									
<b>Type</b>										
-:	Connector with standard crimp contacts									
Q:	Connector with quadrax crimp contacts									
C:	Connector with short PC tail (male and female #20, #16, #12, #8 quadrax)									
S:	Connector with specific PC tail (male and female #22D only)									
L:	Connector with long PC tail (male and female #22D)									
<b>Shell size:</b>	11, 13, 15, 17, 19, 21, 23, 25									
<b>Plating</b>										
Z:	Black zinc nickel									
F:	Nickel									
B:	Olive green cadmium									
<b>Contact layout:</b>	See tables pages 8 to 11									
<b>Contact type</b>										
P:	Male									
S:	Female									
<b>Orientation:</b>	N									
<b>Specification</b>										
None:	Supplied with contacts									
251:	Connector provided with power contacts (for layout with cavities #8)									
*284:	Quadrax grounded (cts 100Ω)									
308:	Quadrax not grounded (cts 100Ω)									
*384:	Quadrax grounded (cts 150Ω)									
408:	Quadrax not grounded (cts 150Ω)									
<b>Special custom</b>										
None:	Standard plastic cap									
M:	Antistatic plastic cap									
L:	Connector supplied without contacts									

\*Excepted mixed layouts with quadrax and signal contacts. Please consult us.

#### HE 308 Rack and Panel connectors part numbers

<b>Basic series</b>	HE308	26	T	23	01	P	N	7	M
<b>Shell type</b>									
26:	Floating plug for rack, for crimp female contacts, with possibility to mount rear accessory								
27:	Receptacle for rack, for male contacts, with possibility to mount rear accessory								
21:	Receptacle for rack with PC Tail contacts								
<b>Class</b>									
T:	Sealed								
<b>Shell size:</b>	11, 13, 15, 17, 19, 21, 23								
<b>Contact layout:</b>	See tables pages 8 to 11								
<b>Contact type</b>									
P:	Male								
S:	Female								
<b>Orientation:</b>	N								
<b>Plating</b>									
7:	Olive green cadmium								
<b>Contractual specifications</b>									
M:	DAT quality insurance								
<b>Special custom</b>									
None:	Standard plastic cap								
M:	Antistatic plastic cap								
<b>Specifications</b>									
None:	Connector supplied with contact								
L:	Connector supplied without contact								

# 8LT Series

## MIL-DTL-38999 Series I

### Rack and Panel - Dimensions

#### Equipment receptacle (type 27)

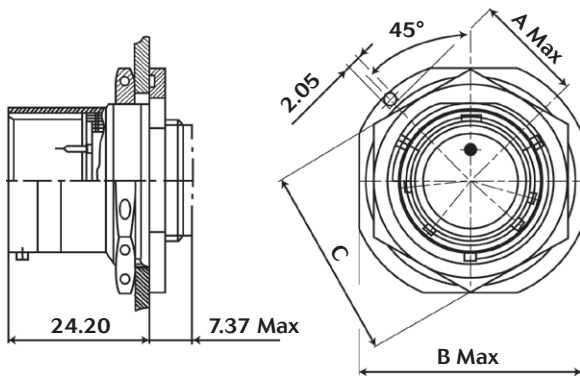

Shells	11	13	15	17	19	21	23	25
A Max	15.33	16.92	18.51	20.1	22.67	24.26	25.84	27.43
B Max	32.16	35.34	38.51	41.69	46.43	49.64	52.78	56
C	25.55	30.3	33.45	36.65	39.8	43	46.15	50.95

#### Square flange receptacle (type 23)

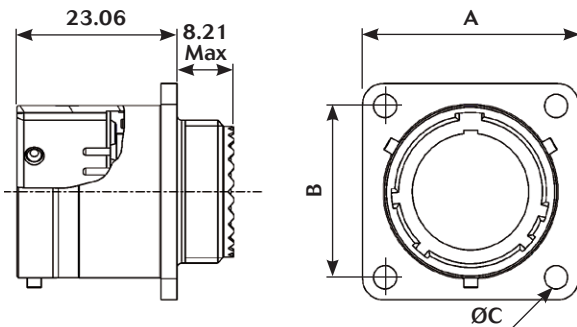

Shells	09	11	13	15	17	19	21	23	25
A Min	23.7	26.05	28.5	30.85	33.2	36.4	39.55	42.75	46
A Max	24.3	26.7	29.05	31.45	33.8	37	40.15	43.35	46.5
B	18.26	20.62	23.01	24.61	26.97	29.36	31.75	34.93	38.1
ØC Min	3.25						3.73		
ØC Max	3.35						3.83		

#### Rack plug (type 26)

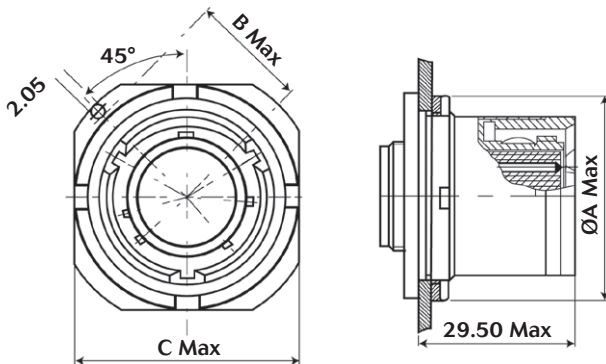

Shells	11	13	15	17	19	21	23	25
A Max	32.1	35.25	38.4	41.6	46.3	49.6	52.7	55.9
B Max	16.92	18.51	20.1	22.67	24.26	25.84	27.43	29.03
C Max	32.16	35.34	38.51	41.69	46.43	49.64	52.78	55.96

Note: All dimensions are in millimeters (mm)

# 8LT Series

## MIL-DTL-38999 Series I

### Mated connectors

Plug type 26 & Receptacle type 23

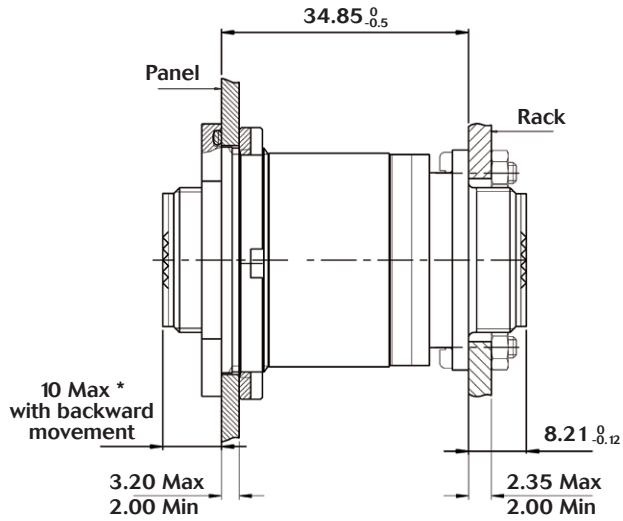

Plug type 26 & Receptacle type 27

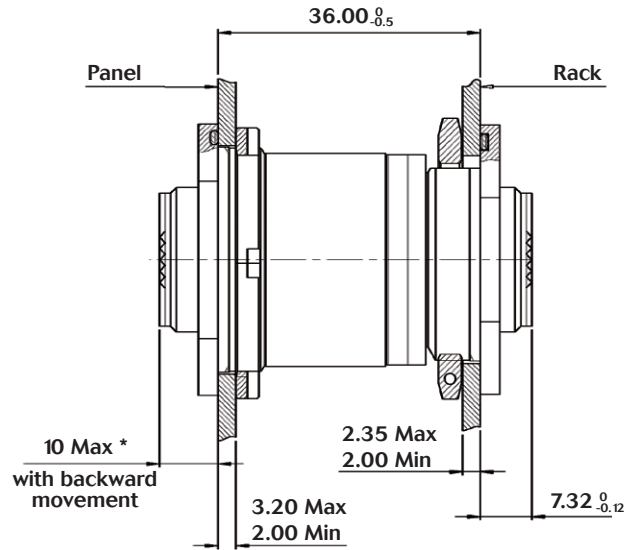

\*Included longitudinal alignment

### Panel cut out

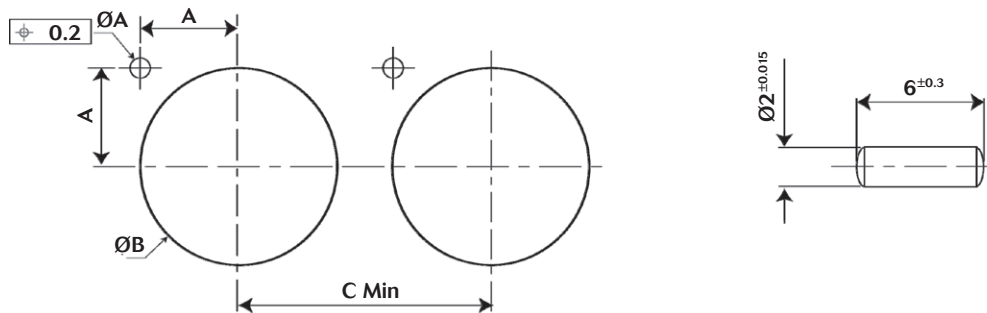

Shell size	Plug			
	A	$\text{ØB}^{\pm 0.1}$	C Min	$\text{ØA}$
11	12.81	25.58	32.57	$2^{\circ}_{-0.05}$
13	13.94	28.80	36	
15	15.06	31.98	39.60	
17	16.88	35.15	43.30	
19	18	38.28	47	
21	19.12	41.50	50.60	
23	20.24	44.68	54.20	
25	21.38	47.85	57.45	

Shell size	Receptacle			
	A	$\text{ØB}^{\pm 0.1}$	C Min	$\text{ØA}$
09	10	17.70	27.80	$2^{\circ}_{-0.05}$
11	11.69	20.86	32.57	
13	12.81	25.58	36	
15	13.94	28.80	39.60	
17	15.06	31.98	43.30	
19	16.88	35.15	47	
21	18	38.28	50.60	
23	19.12	41.50	54.20	
25	20.24	44.68	59.70	

Note: All dimensions are in millimeters (mm)

# 8LT Series

## MIL-DTL-38999 Series I

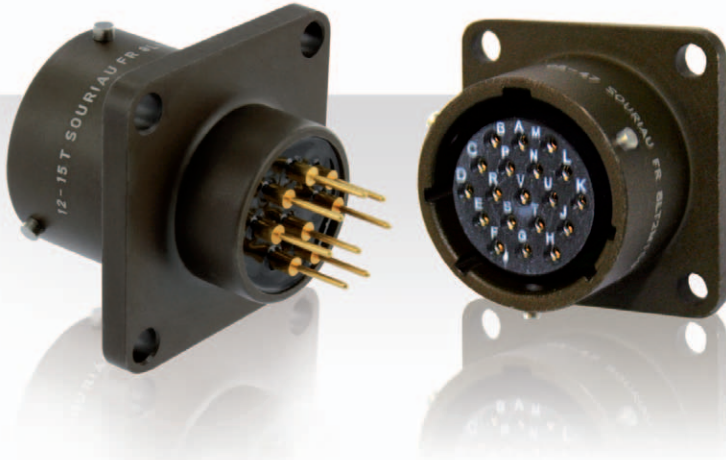

### Cost effective & light hermetics Resin sealed

- Potted receptacle with male or female straight PC tail contacts
- 100% scoop proof: no interference when mating the connector, contacts never touch each other
- Weight saving compared to hermetic version
- Reinforced sealing for harsh environment (10E<sup>-7</sup> atm.cm<sup>3</sup>/s)
- Good shock resistance - better than hermetic glass seal
- Female contacts available for the receptacle
- PC Tail from #22D to #16 (for all other contacts please consult us)

## Ordering information

Basic Series	8LTR	0	C	09	B	35	P	N
<b>Shell style</b>								
0: Square flange receptacle								
1: In line receptacle								
2: Short square flange receptacle not accepting backshell								
3: Square flange receptacle (rear mounting)								
5: Plug with RFI shielding								
7: Jam nut receptacle								
15 : Plug with RFI shielding not accepting backshell								
<b>Type</b>								
C: Receptacle with short PC tail (male and female #22D, #20, #16)								
L: Connector with long PC tail (male and female #22D)								
S: Connector with specific PC Tail (male and female #22D)								
M: Connector with medium PC tail (male #22D)								
P: Connector with solder cup: . Pin: #22D & #16; Socket: #12								
. Socket: #22D & #16; Pin: #12 - Please consult us								
<b>Shell size:</b> 09 - 11 - 13 - 15 - 17 - 19 - 21 - 23 - 25								
<b>Plating</b>								
B: Olive green cadmium								
F: Nickel								
ZC: Green zinc cobalt								
Z: Black zinc nickel								
<b>Contact layouts:</b> see tables pages 8 to 11								
<b>Contact type</b>								
P: Male								
S: Female								
<b>Orientation <sup>(1)</sup></b>								
N - A - B - C - D see table page 48								

(1) Orientation B & C not developed for shell size number 9



8  
BIT  
Series.



8LT Series











# Contacts & Tooling

■	Contacts:	
	Crimp contacts .....	36
	Straight PC tail contacts .....	38
	Coaxial contacts #12 .....	39
	Solder cup .....	39
	Crimp contacts: 1500 mating .....	39
	Wire wrap contacts .....	39
	Quadrax #8 contacts .....	39
	Thermocouple contacts .....	40
	Dummy contacts .....	40
	Filler plugs .....	40
■	Wiring instructions .....	41
■	Tooling:	
	Crimping tools .....	42
	Insertion & extraction tools.....	43
	Backshell tightening tools .....	43
	Tightening support.....	43
	Slackening tools .....	43
	Tightening of fixing nuts, receptacle type 7 .....	43

# 8LT Series

## MIL-DTL-38999 Series I

### Crimp contacts

Contact size	Contact type	Souriau Part number (without color code)	MIL-DTL-38999 contacts		
			Part number	Profile and color code	
#26	Pin	8599-0297	-		
	Socket	8599-0298	-		
#22D	Pin	8599-0702 JJ	M39029/58 360	 Black / Blue / Orange	
	Socket	8599-0706 900	M39029/56 348	 Grey / Yellow / Orange	
#20	Pin	8599-0703 SA	M39029/58 363	 Orange / Blue / Orange	
	Socket	8599-0707 900	M39029/56 351	 Brown / Green / Orange	
#16	Pin	8599-0704 MJ	M39029/58 364	 Yellow / Blue / Orange	
	Socket	8599-0708 900	M39029/56 352	 Red / Green / Orange	
#16 Coaxial	Pin	-	M39029/76 424	 Yellow / Red / Yellow	
	Socket	-	M39029/77 428	 Grey / Red / Yellow	
#12	Pin	8599-0705 MJ	M39029/58 365	 Green / Blue / Orange	
	Socket	8599-0709 900	M39029/56 353	 Orange / Green / Orange	
#12 Coaxial	Pin	-	M39029/102 558		
	Socket	-	M39029/103 559		
	Pin	-	M39029/28 211		
	Socket	-	M39029/75 416		
#10 Power	Pin	-	M39029/58 528		
	Socket	-	M39029/56 527		
#8 Power	Pin	8599-7544 *	-		
	Socket	8599-7541 *	-		
	Pin	8599-7580	-		
	Socket	8599-7581	-		
	Boot		8599-4542	-	For wire #8
			8599-4547	-	For wire #10
Reductor		8599-7645	-		
#8 Coaxial	Pin	-	M39029/60 367		
	Socket	-	M39029/59 366		
	Boot	8590-4571	-		
#8 Twinax	Pin	-	M39029/90 529		
	Socket	-	M39029/91 530		
	Boot	8590-4571	-		
#4 Power	Pin	8599-7598 900 **	-	For wire 25 mm <sup>2</sup>	
	Socket	8599-7599 900 **	-		
	Pin	8599-7534	-	For wire 21.15 mm <sup>2</sup>	
	Socket	8599-7535	-		
	Boot	for cable 16 mm <sup>2</sup>	8599-4594	-	
		for cable 10 mm <sup>2</sup>	8599-4593	-	
Reductor cable 10 mm <sup>2</sup>		8400-2351A	-		
#4 Power with reduced barrel	Pin	8599-7528 900	-	Mating part #4 / Barrel #6	
	Socket	8599-7529 900	-		
	Boot	8599-4593	-		

\* JVS only. \*\* Not included in connector Part number. Must be ordered separately.



# 8LT Series

## MIL-DTL-38999 Series I









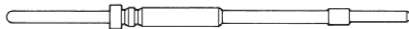

### Crimp contacts

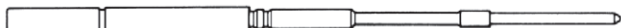
Contact size	Contact type	Contact Ø	Conductor section AWG		Conductor section mm <sup>2</sup>		External Ø over insulator	
			Min	Max	Min	Max	Min	Max
#26	Pin	0.50	30	24	0.055	0.215	0.60	0.83
	Socket							
#22D	Pin	0.76	26	22	0.012	0.34	0.76	1.37
	Socket							
#20	Pin	1.00	24	20	0.21	0.60	1.02	2.11
	Socket							
#16	Pin	1.60	20	16	0.60	1.34	1.65	2.77
	Socket							
#16 Coaxial	Pin	1.60	RG 174 RG 179 RG 316				1.65	2.60
	Socket							
#12	Pin	2.40	14	12	1.91	3.18	2.46	3.61
	Socket							
#12 Coaxial	Pin	2.40	RG 174 RG 179 RG 316				2.40	2.60
	Socket							
	Pin							
	Socket							
#10 Power	Pin	3.20	Please consult us				-	2.95
	Socket							
#8 Power	Pin	3.64	-	8	-	8.98	-	-
	Socket		-	-	-	-	4.50	6.50
	Boot		-	-	-	-	2.50	4
	Reductor		-	-	-	-	-	-
#8 Coaxial	Pin	3.64	RG 180 A/U				-	2.80
	Socket							
	Boot							
#8 Twinax	Pin	5.50	0,76MIL-C17/176 00002 FILECA F.2703/14 RAYCHEM CHEMINAX 10612 FILOTEX M 17/176 00002				3.15	3.40
	Socket							
	Boot							
#4 Power	Pin	5.74	-	3	-	25	-	-
	Socket		5	4	16	21.15	-	-
	Pin		-	-	-	-	6.35	7.50
	Socket		-	-	-	-	4	5.80
	Boot		-	-	-	-	-	-
	Reductor cable 10 mm <sup>2</sup>		-	-	-	-	-	-
#4 Power with reduced barrel	Pin	5.74	6		13.3		-	-
	Socket							
	Boot		-	-	-	-		

# 8LT Series

## MIL-DTL-38999 Series I

### Straight PC tail contacts

Contact size	Contact type	PC tail type	Part number	Profile
#22D	Pin	L	8599-0720 900	
	Pin	M	8599-8028 900	-
	Pin	C	8599-0730 900	
	Pin	S	8599-0796 900	
	Socket	L	8599-0721 900	
	Socket	C	8599-0731 900	
	Socket	S	8599-0797 900	
#20	Pin	M	8599-0658 JJ	-
	Socket	M	8599-0759 900	-
	Pin	C	8599-0724 900	
	Socket	C	8599-0725 900	
	Pin	L	8599-0771 900	-
	Socket	L	8599-0772 900	-
#16	Pin	C	8599-0726 900	
	Socket	C	8599-0727 900	
Coaxial #16	Pin	C	8599-1000A 900	
#12	Pin	C	8599-7929 900	-
	Socket	C	8599-7932 900	-

S: Specific PC tail  
 L: Long PC tail  
 M: Medium PC tail  
 C: Short PC tail

# 8LT Series

## MIL-DTL-38999 Series I

### Coaxial contacts #12

Designation	Part number
Coax socket solder contact #12	THA1-0151A
Coax pin solder contact #12	THA1-0152A
Coax pin crimp contact #12	THA1-0155A
Coax socket crimp contact #12	THA1-0156A

### Solder cup



Contact size	Contact type	Part number
#22D	Pin	8599-0750 900
#20	Pin	8599-0077A 900
#16	Pin	8599-7482A 900
#12	Socket	8599-7485A 900

For other contacts type please consult us.

### Crimp contacts: 1500 mating

Contact size	MIL-DTL-38999 contacts		
	Contact type	Part number	Color code
#22D	Pin (H)	M39029/107 620	Blue / Red / Black
	Socket (J)	M39029/106 614	Blue / Brown / Yellow
#20	Pin (H)	M39029/107 621	Blue / Red / Brown
	Socket (J)	M39029/106 615	Blue / Brown / Green
#16	Pin (H)	M39029/107 622	Blue / Red / Red
	Socket (J)	M39029/106 616	Blue / Brown / Blue
#12	Pin (H)	M39029/107 623	Blue / Red / Orange
	Socket (J)	M39029/106 617	Blue / Brown / Gray

### Wire wrap contacts

Contact size	Contact type	Part number	Contact Ø (mm)	Profile	 (mm)
#22D	Pin	8599-0790 JJ	0.76		0.86
#20	Pin	8599-0791 900	1		0.86







### Quadrax #8 contacts

Contact type	Version	Souriau Part Number	Cross Norm	T°	Impedance	Sealing	Release
Pin	PCB mount	ETH1-1237A	-	125°C	100Ω	Sealed	Rear
		ETH1-1501A	-		150Ω		
	Crimp	ETH1-1345A	EN3155-074	200°C	100Ω		
		ETH1-1503A	-		150Ω		
Socket	PCB mount	ETH1-1238A	-	125°C	100Ω		
		ETH1-1502A	-		150Ω		
	Crimp	ETH1-1346A	EN3155-075	200°C	100Ω		
		ETH1-1504A	-		150Ω		

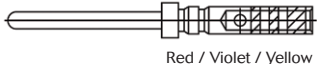
# 8LT Series

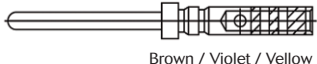
## MIL-DTL-38999 Series I

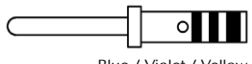
### Thermocouple contacts

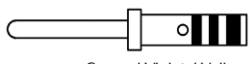
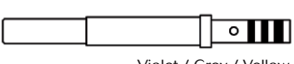
Contact size	Contact type	Souriau part numbers (without color code)	MIL-DTL-38999 contacts		Ø Contact (mm)	Wire section				Ø Over insulation (mm)	
			Part numbers	Profile and color code		Awg		mm <sup>2</sup>		min	max
						min	max	min	max		
#22D Chromel	Pin	-	M39029/87-472	 Red / Violet / Yellow	0.75	28	22	0.095	0.34	0.76	1.37
	Socket	-	M39029/88-484	 Yellow / Grey / Yellow							
#22D Alumel	Pin	-	M39029/87-471	 Brown / Violet / Yellow							
	Socket	-	M39029/88-483	 Orange / Grey / Yellow							
#20 Chromel	Pin	8599-0749 900	8599-0949 900	 Blue / Violet / Yellow	1	24	20	0.21	0.6	1.02	2.11
	Socket	8599-0753 900	8599-0953 900	 Grey / Grey / Yellow							
#20 Alumel	Pin	8599-0761 900	8599-0961 900	 Green / Violet / Yellow							
	Socket	8599-0765 900	8599-0965 900	 Violet / Grey / Yellow							

### Dummy contacts

Size	Part number
#16	8599-6A016001A
#8	8599-0308
#4	8599-0310

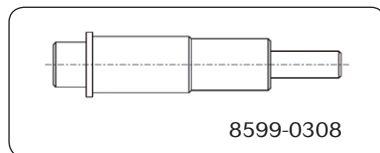

### Filler plugs

Contact size	Filler plugs		
	MS Part number (Rev. N)	Souriau Part number	Color
#22D	MS27488-22-2	8660-212	Black
#20	MS27488-20-2	8522-389A	Red
#16	MS27488-16-2	8522-390A	Green
#12	MS27488-12-2	8522-391A	Orange

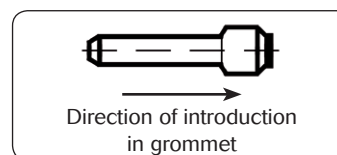

These filler plugs are installed at the rear of unwired contact to maintain connector sealing.

# 8LT Series

## MIL-DTL-38999 Series I

### Wiring instruction

#### Cable preparation and wire stripping

Contact size	#26	#22D	#20	#16	#12	#8	#4
L	4		6			12	

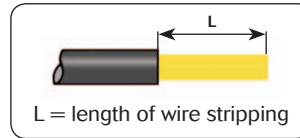

#### Insertion of wire in contact barrel

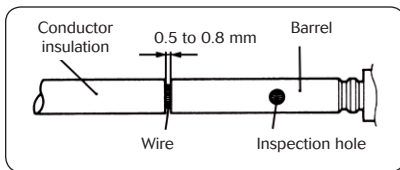

When inserting the stripped wire into the contact barrel check that no strands are left outside and that the wire is visible through the wire inspection hole in the barrel.

*Important:*

- Slide any accessories over wire strands before carrying out the following operations.
- Contacts are inserted and extracted from the rear of the connector.

#### Insertion of the contacts

1 - Engage the crimp cable / contact assembly into the longitudinal slot of the plastic tool (coloured tip). Slide the tool down the cable until the tip of the tool abuts the contact retention shoulder.

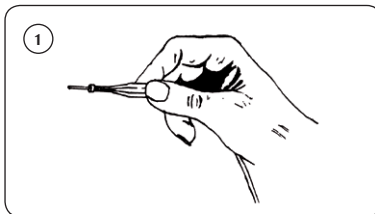

2 - Introduce the contact into the required contact cavity in the insulator, pushing tool axially, until the contact snaps into position in clip.

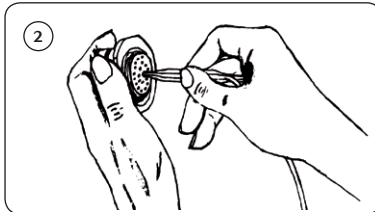

3 - Withdraw the tool (from rear). Check that contact is firmly locked by pulling wire gently. When connector is fully loaded, check the position of contact tips. They should all be in the same plane. Nota: For larger sizes of cable which are stiff enough manual insertion without tool is preferable.

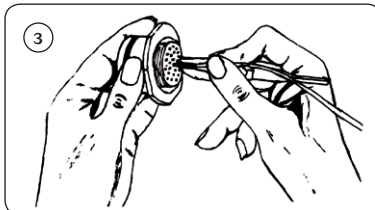

#### Extraction of the contacts

1 - Engage the appropriate cable into the longitudinal slot of the tool with the white tip towards connector.

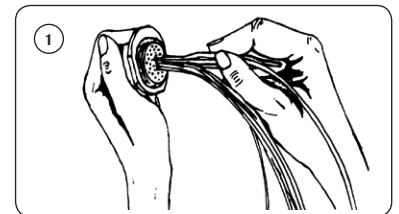

2 - Slide the tool down towards the contact. Insert the tool in the insulator until it abuts the contact shoulder.

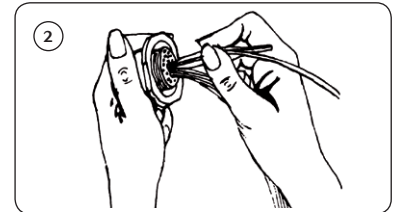

3 - Holding the tool-contact and cable assembly together, remove them simultaneously.

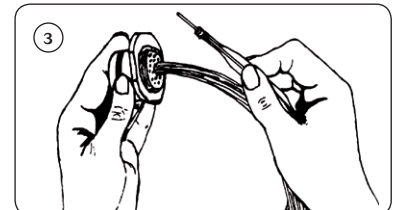

# 8LT Series

## MIL-DTL-38999 Series I

### Tooling

#### Crimping tools

Contact size	Contact type	Plier M22520/1-01		Plier M22520/2-01 (Souriau 8476-01)		Plier M300BT	Plier * M22520/23-01	
		Turret Part number		Locator Part number		Locator Part number	Turret Part number	Locator Part number
		Norm	Souriau	Norm	Souriau			
#26	Pin	-	-	-	8599-0397	-	-	-
	Socket	-	-	-	8599-0398	-	-	-
#22D	Pin	-	-	M22520/2-09	8476-09	-	-	-
	Socket	-	-	M22520/2-06	-	-	-	-
#20	Pin	M22520/1-04	8365-04	M22520/2-10	8476-10	-	-	-
	Socket					-	-	-
#16	Pin	M22520/1-04	8365-04	-	-	-	-	-
	Socket			-	-	-	-	
#12	Pin	M22520/1-04	8365-04	-	-	-	-	-
	Socket			-	-	-	-	
#8 Power	Pin	-	-	-	-	SP 593	M22520/23-02	8599-9601
	Socket	-	-	-	-			
#4 Power	pin	-	-	-	-	-	M22520/23-04	M22520/23-11
	Socket	-	-	-	-	-		

Contact size	Contact type	Plier M22520/2-01 (Souriau 8476-01)	Plier M22520/31-01	Plier M22520/4-01	Plier M22520/5-01
		Locator Part Number	Locator Part number	Locator Part Number	Die set Part Number
#12 Coaxial M39029/102-558 M39029/103-559	Inner	-	-	-	M22520/5-03
	Outer	-	-	-	
#12 Coaxial M39029/28-211 M39029/75-416	Inner	M22520/2-34	-	-	-
	Outer	-	M22520/31-02	-	-
#16 Coaxial	Inner	M22520/2-35	-	-	-
	Outer	-	-	M22520/4-02	-
#8 Coaxial	Inner	M22520/2-31	-	-	-
	Outer	-	-	-	M22520/5-05 closure B
#8 Triaxial	Inner	K709	-	-	-
	Middle	-	-	-	Y631 closure B
	Ferrule	-	-	-	Y631 closure A

\* Pneumatic plier

Note: for the #10 contact's plier and locator, please consult us.

# 8LT Series

## MIL-DTL-38999 Series I

### Insertion & extraction tools

Contact size	Material	Part number		Color	
		MIL standard	Souriau	Insertion	Extraction
#26	Plastic	-	8599-0399 900	Black	White
#22D	Plastic	M81969/14-01	-	Green	White
#20	Plastic	M81969/14-10	-	Red	Orange
#16	Plastic	M81969/14-03	-	Blue	White
#12	Plastic	M81969/14-04	-	Yellow	White
#10	Plastic	M81969/14-05	-	Grey	-
#8	Plastic	M81969/14-12	-	-	Green
	Metalic	-	8660-197	-	-
#4	Plastic	M81969/14-07	-	-	Blue
	Metalic	-	8533-8175	-	-

### Backshell tightening tools

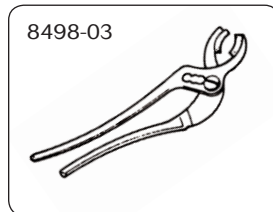

8498-03

Backshell tightening pliers,  
part number: **8498-03**  
Square jaws (order 2 jaws),  
part number: **8500-1015**

### Tightening support

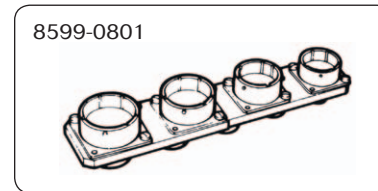

8599-0801

Part number: **8599-0801**  
This tool is made up of  
dummy receptacles  
 housings of all 9 sizes for all  
key polarisation, and secures  
free connectors during wiring  
and fitting of rear accessories.

### Tightening of rear accessories:

Shell size	9	11	13	15	17	19	21	23	25
Max torque in m/daN	0.62						1.24		

### Slackening tools

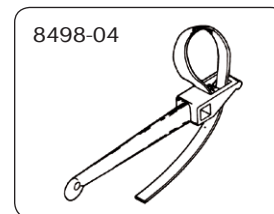

8498-04

Strap clamp,  
part number: **8498-04**  
Spare strap,  
part number: **8498-103**

### Tightening of fixing nuts, receptacle type 7

Shell size	09	11	13	15	17	19	21	23	25
Nut dimension across flats	22.35	25.55	30.30	33.45	36.65	39.80	43.00	46.10	50.95
Max tightening torque on nut (mN)	6	8	10	13	20	23	25	26	28

8  
BIT  
Series.





8LT Series

# Common Section

■ Protective caps .....	46
■ Reductors .....	47
■ Boots .....	48
■ Orientations .....	48
■ Panel gasket .....	49
■ Dummy receptacles .....	49
■ Cross reference list .....	50
■ Coordinates information .....	52

# 8LT Series

## MIL-DTL-38999 Series I

### Protective caps

#### Metallic protective caps - Dimensions

Metallic protective cap for receptacles

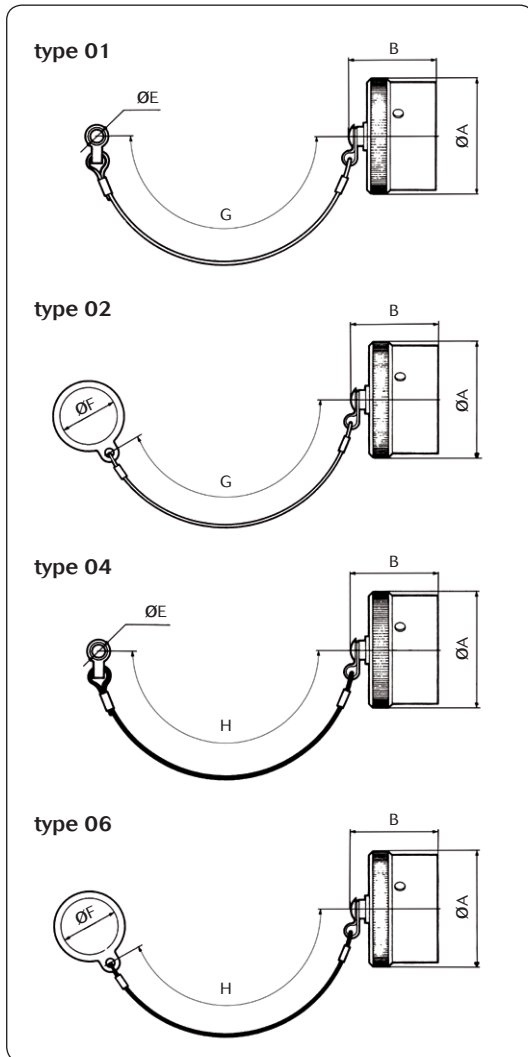

Metallic protective cap for plugs

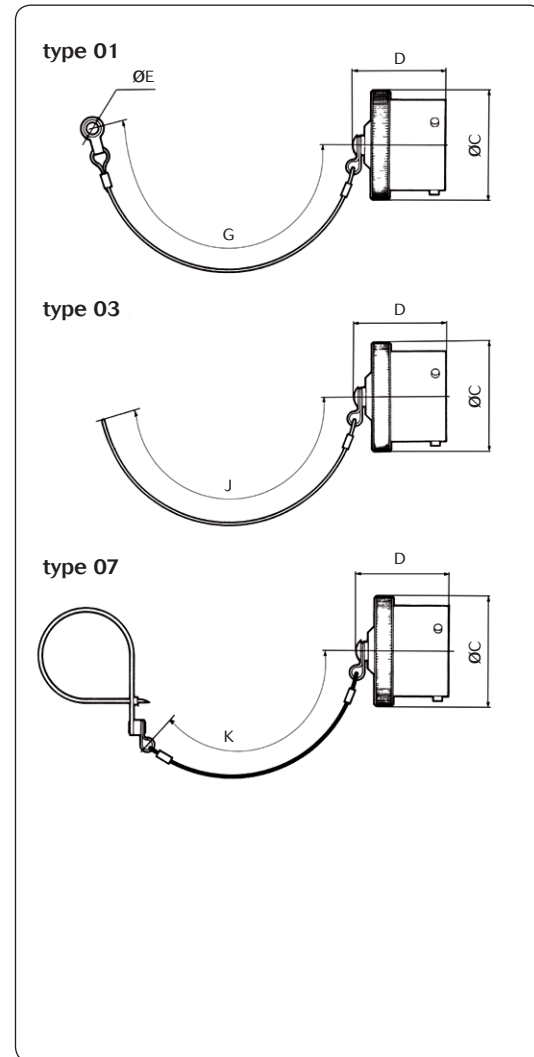

Shell size	ØA Max	B Max	ØC Max	D Max	ØE Min	ØF Min	G	H <sup>±5</sup>	J <sup>±5</sup>	K <sup>±5</sup>
09	21.80	28.00	20.80	29.50	3.20	17.80	76	105	200	160
11	24.90		23.80			21.30				
13	29.40		27.70			25.70				
15	32.50		30.20			89	102			
17	35.80		33.50							
19	38.60		36.50							
21	41.90		39.80							
23	44.90		42.90			102				
25	48.00		46.20							

Note: All dimensions are in millimeters (mm)

# 8LT Series

## MIL-DTL-38999 Series I

### Protective caps

#### Metallic protective caps - Ordering

Basic series	8LT	E	01	B	13
<b>Cap type</b>					
E: Cap for receptacle					
F: Cap for plug					
<b>Fixing type</b>					
<b>Cap for receptacle</b>			<b>Cap for plug</b>		
01: Plastic sleeved metal cord with eyelet			01: Plastic sleeved metal cord with eyelet		
02: Plastic sleeved metal cord with ring			03: Nylon cord without fastener		
04: Nylon cord with eyelet			07: Nylon cord with strap		
06: Nylon cord with ring					
10: Black nylon cord with eyelet					
<b>Plating</b>					
B: Olive green cadmium					
F: Nickel					
<b>Shell size:</b>					
09 - 11 - 13 - 15 - 17 - 19 - 21 - 23 - 25					

#### Plastic protective caps

Shell size	Part numbers for standard cap		Part numbers for antistatic cap	
	Caps for receptacle	Caps for plug	Caps for receptacle	Caps for plug
09	8500-5594	70609	MS90376-10RF	MS90376-14RF
11	MS90376-12R	MS90376-16Y	MS90376-12RF	MS90376-16RF
13	8500-5588A	8500-5600	8500-5588N	8500-5600N
15	8500-5589A	8500-5601	MS90376-18YF	8500-5601N
17	MS90376-20YF	8500-5602	MS90376-20YF	8500-5602N
19	8500-5601	8500-5592A	8500-5601N	8500-5592N
21	8500-5602	8500-5593A	8500-5602N	8500-5593N
23	MS90376-24R	MS90376-24R	MS90376-24RF	-
25	8500-5593A	J599ABC6009A00	8500-5593N	-

### Reducers

Reducer Size	Part number	For cable	For pin contacts	For socket contacts
#8 Power	8599-7645	#10	8599-7580	8599-7581
#4 Power	8400-2352A	10 mm <sup>2</sup>	8599-7534A	8599-7535A

# 8LT Series

## MIL-DTL-38999 Series I

### Boots

Boot Size	Part number	Admissible wire section mm <sup>2</sup>		For cable
#8 Power	8599-4542	5	6.5	8.48 à 10 mm <sup>2</sup>
	8599-4547	2.5	4	#10
#4 Power	8599-4594	6.35	7.5	#4 - #5
	8599-4593	4	5.8	#6 - #8

### Orientations

Polarization is determined by the master keyway position.  
The secondary keyway positions remain fixed.

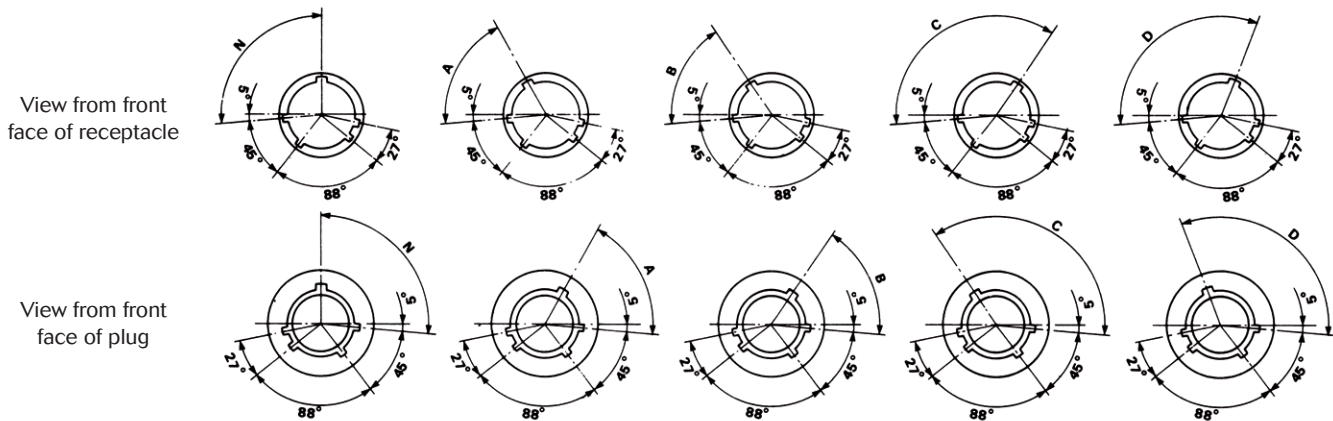

Shell size	Angles (degrees)				
	N	A	B	C	D
09	95	77	-	-	113
11	95	81	67	123	109
13	95	75	63	127	115
15	95	74	61	129	116
17	95	77	65	125	113
19	95	77	65	125	113
21	95	77	65	125	113
23	95	80	69	121	110
25	95	80	69	121	110

# 8LT Series

## MIL-DTL-38999 Series I

### Panel gasket

Shell size	Part numbers	
	Gasket for receptacle type 0, 2, 3 (to be ordered separately)	O ring for receptacle type 7 (shipped with connector)
09	8599-5541	AS3582-019
11	8599-5542	AS3582-022
13	8599-5543	AS3582-024
15	8599-5544	AS3582-026
17	8599-5545	AS3582-028
19	8599-5546	AS3582-128
21	8599-5547	AS3582-130
23	8599-5548	AS3582-132
25	8599-5549	AS3582-134

### Dummy receptacles

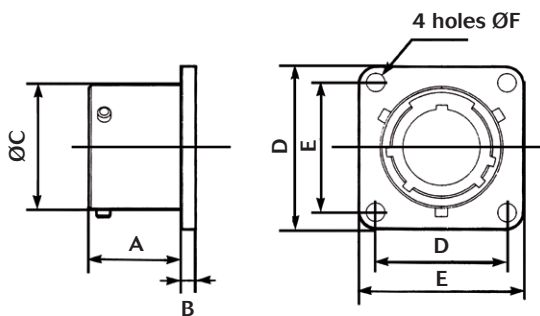

Shell size	Part numbers*	A Max	B Max	ØC Max	D Max	E	ØF
09	8LT0-09GUR	16.05	2.54	14.53	24.25	18.26	3.25
	8LT0-09FUR						
11	8LT0-11GUR	16.05	2.54	17.78	26.60	20.62	3.25
	8LT0-11FUR						
13	8LT0-13GUR	16.05	2.54	21.59	29.00	23.01	3.25
	8LT0-13FUR						
15	8LT0-15GUR	16.05	2.54	24.77	31.35	24.61	3.25
	8LT0-15FUR						
17	8LT0-17GUR	16.05	2.54	27.94	33.75	26.97	3.25
	8LT0-17FUR						
19	8LT0-19GUR	16.05	2.54	30.66	36.90	29.36	3.25
	8LT0-19FUR						
21	8LT0-21GUR	15.29	3.30	33.83	40.10	31.75	3.25
	8LT0-21FUR						
23	8LT0-23GUR	15.29	3.30	37.00	43.25	34.93	3.73
	8LT0-23FUR						
25	8LT0-25GUR	15.29	3.30	40.18	46.50	38.10	3.73
	8LT0-25FUR						

\* F or G = Plating.

Note: All dimensions are in millimeters (mm)

# 8LT Series

## MIL-DTL-38999 Series I

### Cross reference list :

#### Part Numbers Souriau and Specifications : NFC 93422 / MIL DTL 38999

#### Connectors

SOURIAU	NFC 93422 HE 308	MIL DTL 38999 Serie I	Designation
8LT0●●B●●P/SN 8LT0●●F●●P/SN	HE30800T●●●●P/SN7 M HE30800T●●●●P/SN6 M	MS27466T●●B●●P/S●* MS27466T●●F●●P/S●*	Square flange receptacle
8LT1●●B●●P/SN 8LT1●●F●●P/SN	- -	- -	Cable connecting receptacle
8LT2●●B●●P/SN 8LT2●●F●●P/SN	- -	MS27505E●●B●●P/S●* MS27505E●●F●●P/S●*	Square flange receptacle not accepting backshell
8LT3●●B●●P/SN 8LT3●●F●●P/SN	- -	MS27656T●●B●●P/S●* MS27656T●●F●●P/S●*	Square flange receptacle (rear mounting)
8LT5●●B●●P/SN 8LT5●●F●●P/SN	HE30806T●●●●P/SN7 M HE30806T●●●●P/SN6 M	MS27467T●●B●●P/S●* MS27467T●●F●●P/S●*	Plug with RFI shielding
8LT15●●B●●P/SN 8LT15●●F●●P/SN	- -	MS27467E●●B●●P/S●* MS27467E●●F●●P/S●*	Plug with RFI shielding not accepting backshell
8LT7●●B●●P/SN 8LT7●●F●●P/SN	HE30807T●●●●P/SN7 M HE30807T●●●●P/SN6 M	MS27468T●●B●●P/S●* MS27468T●●F●●P/S●*	Jam nut receptacle
8LT7S●●B●●P/SN (#22D) 8LT7S●●F●●P/SN (#22D)	HE30811T●●●●P/SN7 M HE30811T●●●●P/SN6 M	- -	Jam nut receptacle with PC Tail contacts
8LT7C●●B●●P/SN (#20, #16, #12) 8LT7C●●F●●P/SN (#20, #16, #12)	HE30811T●●●●P/SN7 M HE30811T●●●●P/SN6 M	- -	Jam nut receptacle with PC Tail contacts
8LT26●●B●●P/SN 8LT26●●F●●P/SN	HE30826T●●●●P/SN7 M -	- -	Floating plug for rack HE308
8LT27●●B●●P/SN 8LT27●●F●●P/SN	HE30827T●●●●P/SN7 M -	- -	Receptacle for rack HE308 with possibility to mount rear accessories
8LT27S●●B●●P/SN (#22D) 8LT27C●●B●●P/SN (#20, #16, #12)	HE30821T●●●●P/SN7 M HE30821T●●●●P/SN7 M	- -	Receptacle for rack HE308 with PC Tail contacts
8LT23●●B●●P/SN	-	-	Square flange receptacle

\* Standard P/S : . None = N position,  
. Use A,B,C,D for other orientations

#### Backshells

SOURIAU	NFC 93422 HE 308	MIL DTL 38999 Serie I	Designation
8LST●●●B01 8LST●●●F01	- -	M8504927●●W M8504927●●N	Backnut
8LST●●●B02 8LST●●●F02 8LST●●●G02	- HE308-11●●●26 HE308-11●●●27	- - -	Straight cable clamp
8LST●●●B03 8LST●●●F03 8LST●●●G03	- HE308-12●●●26 HE308-12●●●27	- - -	Elbow cable clamp
8LST●●●B071 8LST●●●F071	HE308-13●●●17 HE308-13●●●16	- -	Backshell for screen termination and heatshrink sleeving

# 8LT Series

## MIL-DTL-38999 Series I

### Caps

SOURIAU	NFC 93422 / HE 308	MIL-DTL-38999 Series I	Designation
8LTE04B●● 8LTE04F●●	HE308-B00●●7 HE308-B00●●6	- -	Cap for square flange receptacle
8LTE06B●● 8LTE06F●●	HE308-B07●●7 HE308-B07●●6	- -	Cap for jam nut receptacle
8LTF05B●● 8LTF05F●●	HE308-B16●●7 HE308-B16●●6	- -	Cap for plug
8LTF07B●● 8LTF07F●●	HE308-B06●●7 HE308-B06●●6	- -	Cap for plug
8LTE01B●● 8LTE01F●●	- -	MS27502B●●C MS27502F●●C	Cap for receptacle
8LTE02B●● 8LTE02F●●	- -	MS27502B●●N MS27502F●●N	Cap for receptacle
8LTF01B●● 8LTF01F●●	- -	MS27501B●●C MS27501F●●C	Cap for plug

### Contacts

See page 35

# 8LT Series

## MIL-DTL-38999 Series I

### Coordinates for straight PC tail terminations Viewed from front face of male insulator

Hole sizes: 1mm min. (#22 and #20 contacts) and 1.3mm min. (#16 contact) coordinates in mm.

#### 09 / A

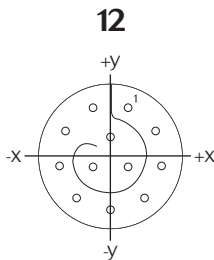

Ctc	X	Y
1	+0.92	+2.54
2	+2.34	+1.35
3	+2.66	-0.47
4	+1.74	-2.07
5	0.00	-2.70
6	-1.74	-2.07

Ctc	X	Y
7	-2.66	-0.47
8	-2.34	+1.35
9	-0.92	+2.54
10	0.00	+1.03
11	+0.89	-0.51
12	-0.89	-0.51

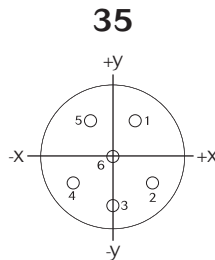

Ctc	X	Y
1	+1.14	+1.98
2	+1.98	-1.14
3	0.00	-2.29
4	+1.98	-1.14
5	+1.14	+1.98
6	0.00	0.00

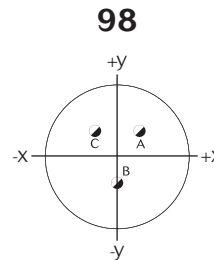

Ctc	X	Y
A	+1.65	+0.97
B	0.00	-1.90
C	-1.65	+0.97

#### 11 / B

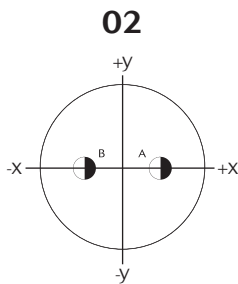

Ctc	X	Y
A	0.00	+2.41
B	0.00	-2.41

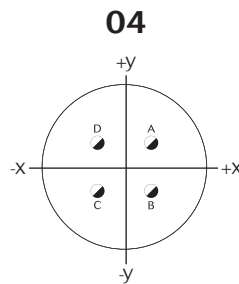

Ctc	X	Y
A	+1.65	+1.65
B	+1.65	-1.65
C	-1.65	-1.65
D	-1.65	+1.65

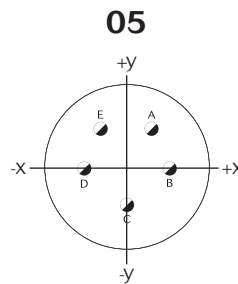

Ctc	X	Y
A	+1.65	+1.42
B	+2.86	-1.65
C	0.00	-3.30
D	-2.86	-1.65
E	-1.65	+1.42

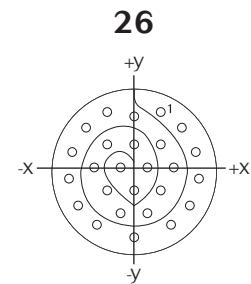

Ctc	X	Y
1	+1.69	+3.79
2	+3.09	+2.77
3	+3.95	+1.28
4	+4.13	-0.44
5	+3.58	-2.10
6	+2.40	-3.37
7	0.00	-4.13
8	-2.40	-3.37
9	-3.58	-2.10
10	-4.13	-0.44
11	-3.95	+1.28
12	-3.09	+2.77
13	-1.69	+3.79

Ctc	X	Y
14	0.00	+3.50
15	+1.70	+1.76
16	+2.55	+0.29
17	+1.70	-1.18
18	+0.85	-2.65
19	-0.85	-2.65
20	-1.70	-1.18
21	-2.55	+0.29
22	-1.70	+1.76
23	0.00	+1.76
24	+0.85	+0.29
25	0.00	-1.18
26	-0.85	+0.29

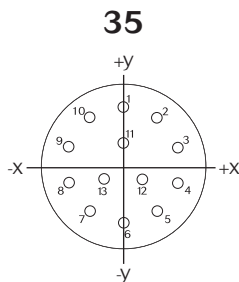

Ctc	X	Y
1	0.00	+3.71
2	+2.16	+3.00
3	+3.51	+1.14
4	+3.51	-1.14
5	+2.16	-3.00

Ctc	X	Y
6	0.00	-3.71
7	-2.16	-3.00
8	-3.51	-1.14
9	-3.51	+1.14

Ctc	X	Y
10	-2.16	+3.00
11	0	+1.42
12	+1.24	-0.89
13	-1.24	-0.89



# 8LT Series

## MIL-DTL-38999 Series I

11 / B

98

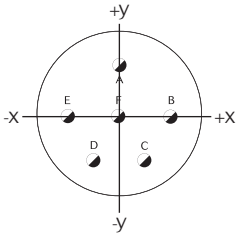

Ctc	X	y
A	0.00	+3.30
B	+3.30	0.00
C	+1.65	-2.87
D	-1.65	-2.87
E	-3.30	0.00
F	0.00	0.00

99

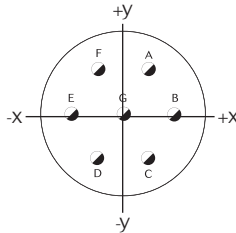

Ctc	X	y
A	+1.65	+2.85
B	+3.30	0.00
C	+1.65	-2.87
D	-1.65	-2.87
E	-3.30	0.00
F	-1.65	+2.87
G	0.00	0.00

13 / C

04

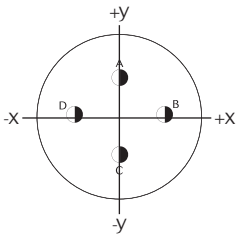

Ctc	X	y
A	0.00	+3.81
B	+3.71	+0.89
C	0.00	-2.11
D	-3.71	+0.89

08

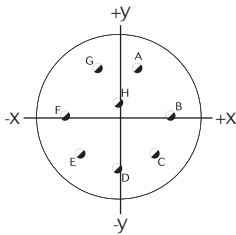

Ctc	X	y
A	+1.65	+3.99
B	+4.32	0.00
C	+3.05	-3.05
D	0.00	-4.32
E	-3.05	-3.05
F	-4.32	0.00
G	-1.65	+3.99
H	0.00	+1.12

35

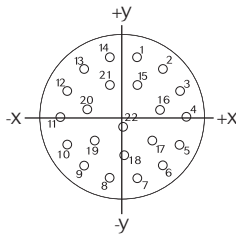

Ctc	X	y
1	+1.14	+5.00
2	+3.20	+4.01
3	+4.62	+2.24
4	+5.16	0.00
5	+4.62	-2.24
6	+3.20	-4.01
7	+1.14	-5.00
8	-1.14	-5.00
9	-3.20	-4.01
10	-4.62	-2.24
11	-5.16	0.00

Ctc	X	y
12	-4.62	+2.24
13	-3.20	+4.01
14	-1.14	+5.00
15	+1.14	+2.72
16	+2.97	+0.66
17	+2.36	-1.91
18	0.00	-3.05
19	-2.36	-1.91
20	-2.97	+0.66
21	-1.14	+2.72
22	0.00	-0.76

43

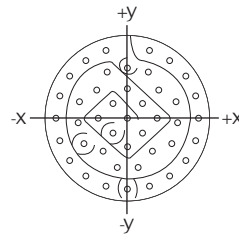

Ctc	X	y
1	+1.80	+5.54
2	-1.80	+5.54
3	+3.42	+4.71
4	+4.71	+3.42
5	+5.54	+1.80
6	+5.82	0.00
7	+5.54	-1.80
8	+4.71	-3.42
9	+3.42	-4.71
10	+1.80	-5.54
11	0.00	-5.82
12	-1.80	-5.54
13	-3.42	-4.71
14	-4.71	-3.42
15	-5.54	-1.80
16	-5.82	0.00
17	-5.54	+1.80
18	-4.71	+3.42
19	-3.42	+4.71
20	0.00	+4.12
21	+1.68	+3.76
22	+2.54	+2.28

Ctc	X	y
23	+3.92	+1.27
24	+4.10	-0.43
25	+3.57	-2.06
26	+1.99	-2.74
27	+0.86	-4.03
28	-0.86	-4.03
29	-1.99	-2.74
30	-3.57	-2.06
31	-4.10	-0.43
32	-3.92	+1.27
33	-2.54	+2.28
34	-1.68	+3.76
35	0.00	+2.42
36	+1.21	+1.21
37	+2.42	0.00
38	+1.21	-1.21
39	0.00	-2.42
40	-1.21	-1.21
41	-2.42	0.00
42	-1.21	+1.21
43	0.00	0.00

98

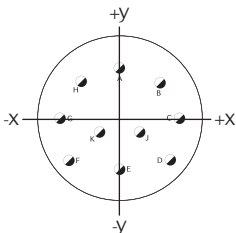

Ctc	X	y
A	0.00	+4.95
B	+3.18	+3.81
C	+4.90	+0.76
D	+4.17	-2.67
E	0.00	-3.43

Ctc	X	y
F	-4.17	-2.67
G	-4.90	+0.76
H	-3.18	+3.81
J	+1.65	-0.38
K	-1.65	-0.38

# 8LT Series

## MIL-DTL-38999 Series I

15 / D

05

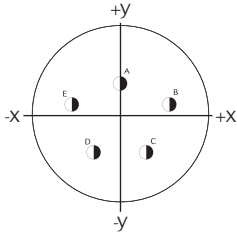

Ctc	X	y
A	0	+2.54
B	+4.42	+0.61
C	+2.39	+3.76
D	-2.39	-3.76
E	-4.42	+0.61

18

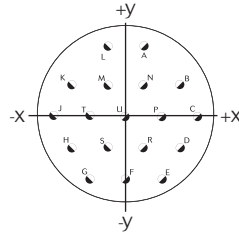

Ctc	X	y
A	+1.65	+6.40
B	+4.95	+2.87
C	+6.60	0.00
D	+4.95	-2.87
E	+3.30	-5.72
F	0.00	-5.72
G	-3.30	-5.72
H	-4.95	-2.87
J	-6.60	0.00
K	-4.95	+2.87
L	-1.65	+6.40
M	-1.65	+2.87
N	+1.65	+2.87
P	+3.30	0.00
R	+1.65	-2.87
S	-1.65	-2.87
T	-3.30	0.00
U	0.00	0.00

19

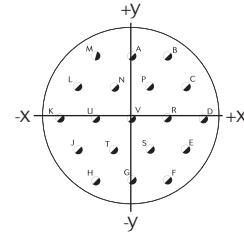

Ctc	X	y
A	0.00	+5.72
B	+3.30	+5.72
C	+4.95	+2.87
D	+6.60	0.00
E	+4.95	-2.87
F	+3.30	-5.72
G	0.00	-5.72
H	-3.30	-5.72
J	-4.95	-2.87
K	-6.60	0.00
L	-4.95	+2.87
M	-3.30	+5.72
N	-1.65	+2.87
P	+1.65	+2.87
R	+3.30	0.00
S	+1.65	-2.87
T	-1.65	-2.87
U	-3.30	0.00
V	0.00	0.00

97

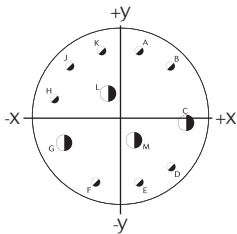

Ctc	X	y
A	+1.65	+5.94
B	+4.52	+4.52
C	+5.84	-0.58
D	+4.52	-4.52
E	+1.65	-5.94
F	-2.26	-5.97
G	-5.26	-2.41
H	-5.94	+1.65
J	-4.52	+4.52
K	-1.65	+5.94
L	-1.19	+2.06
M	+1.19	-2.06

35

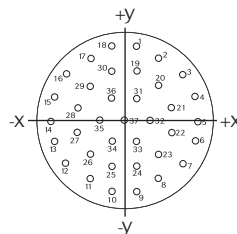

Ctc	X	y
1	+1.14	+6.65
2	+3.12	+5.51
3	+5.36	+4.06
4	+6.45	+2.03
5	+6.75	-0.25
6	+6.27	-2.49
7	+5.08	-4.45
8	+3.30	-5.89
9	+1.14	-6.65
10	-1.14	-6.65
11	-3.30	-5.89
12	-5.08	-4.45
13	-6.27	-2.49
14	-6.76	-0.25
15	-6.45	+2.03
16	-5.36	+4.06
17	-3.12	+5.51
18	-1.14	+6.65
19	+1.14	+4.37
20	+3.12	+3.02
21	+4.32	+1.02
22	+4.32	-1.27
23	+3.12	-3.23
24	+1.14	-4.37
25	-1.14	-4.37
26	-3.12	-3.23
27	-4.32	-1.27
28	-4.32	+1.02
29	-3.12	+3.02
30	-1.14	+4.37
31	+1.14	+1.88
32	+2.29	-0.10
33	+1.14	-2.08
34	-1.14	-2.08
35	-2.29	-0.10
36	-1.14	+1.88
37	0.00	-0.10

# 8LT Series

## MIL-DTL-38999 Series I

17 / E

06

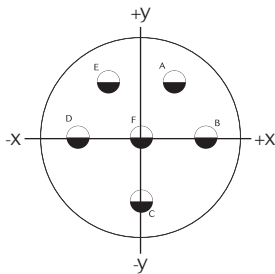

Ctc	X	y
A	+3.07	+5.31
B	+6.12	0.00
C	0.00	-6.12
D	-6.12	0.00
E	-3.07	+5.31
F	0.00	0.00

08

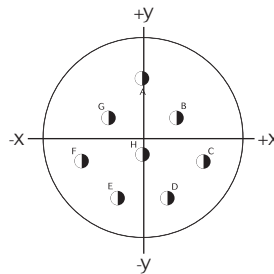

Ctc	X	y
A	0.00	+5.99
B	+3.25	+2.18
C	+5.84	-1.98
D	+2.39	-5.49
E	-2.39	-5.49
F	-5.84	-1.98
G	-3.25	+2.18
H	0.00	-1.32

26

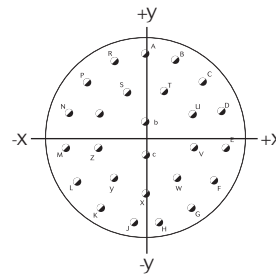

Ctc	X	y
A	0.00	+8.15
B	+3.33	+7.44
C	+6.07	+5.44
D	+7.75	+2.51
E	+8.10	-0.86
F	+7.06	-4.09
G	+4.80	-6.60
H	+1.70	-7.98

Ctc	X	y
J	-1.70	-7.98
K	-4.80	-6.60
L	-7.06	-4.09
M	-8.10	-0.86
N	-7.75	+2.51
P	-6.07	+5.44
R	-3.33	+7.44
S	-1.78	+4.50
T	+1.78	+4.50
U	+4.45	+2.39
V	+4.53	-0.91
W	+3.02	-3.84
X	0.00	-5.16
Y	-3.02	-3.84
Z	-4.53	-0.91
a	-4.45	+2.39
b	0.00	+1.65
c	0.00	-1.65

35

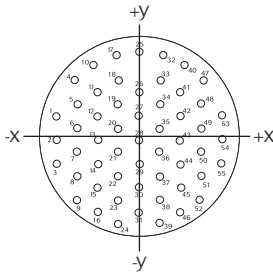

Ctc	X	y
1	-7.92	+2.18
2	-7.92	-0.10
3	-7.92	-2.39
4	-6.15	+5.61
5	-5.94	+3.33
6	-5.94	+1.04
7	-5.94	-1.24
8	-5.94	-3.53
9	-5.94	-5.82
10	-4.37	+7.09
11	-3.96	+4.47
12	-3.96	+2.18

Ctc	X	y
13	-3.96	-0.10
14	-3.96	-2.39
15	-3.96	-4.67
16	-3.96	-6.96
17	-2.26	+8.03
18	-1.98	+5.61
19	-1.98	+3.33
20	-1.98	+1.04
21	-1.98	-1.24
22	-1.98	-3.53
23	-1.98	-5.82
24	-1.98	-8.10

Ctc	X	y
25	0.00	+8.36
26	0.00	+4.47
27	0.00	+2.18
28	0.00	-0.10
29	0.00	-2.39
30	0.00	+4.67
31	0.00	-6.96
32	+2.26	+8.03
33	+1.98	+5.61
34	+1.98	+3.33
35	+1.98	+1.04
36	+1.98	-1.24
37	+1.98	-3.53
38	+1.98	-5.82
39	+1.98	-8.10
40	+4.37	+7.09

Ctc	X	y
41	+3.96	+4.47
42	+3.96	+2.18
43	+3.96	-0.10
44	+3.96	-2.39
45	+3.96	-4.67
46	+3.96	-6.96
47	+6.15	+5.61
48	+5.94	+3.33
49	+5.94	+1.04
50	+5.94	-1.24
51	+5.94	-3.53
52	+5.94	-5.82
53	+7.92	+2.18
54	+7.92	-0.10
55	+7.92	-2.39

99

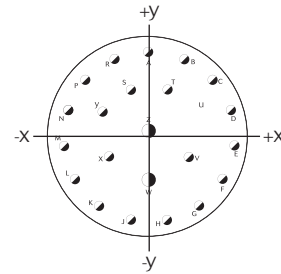

Ctc	X	y
A	0.00	+8.15
B	+3.33	+7.44
C	+6.07	+5.44
D	+7.75	+2.51
E	+8.10	-0.86
F	+7.06	-4.09
G	+4.80	-6.60
H	+1.70	-7.98
J	-1.70	-7.98
K	-4.80	-6.60
L	-7.06	-4.09
M	-8.10	-0.86

Ctc	X	y
N	-7.75	+2.51
P	-6.07	+5.44
R	-3.33	+7.44
S	-1.78	+4.50
T	+1.78	+4.50
U	+4.45	+2.39
V	+3.81	-1.91
W	0.00	-4.09
X	-3.81	-1.91
Y	-4.45	+2.39
Z	0.00	+0.64

# 8LT Series

## MIL-DTL-38999 Series I

19 / F

11

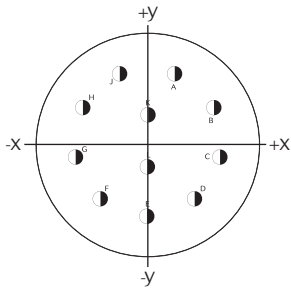

Ctc	X	y
A	+2.67	+6.60
B	+6.35	+3.35
C	+6.99	-1.35
D	+4.55	-5.46
E	0.00	-7.14
F	-4.55	-5.46
G	-6.99	-1.35
H	-6.35	+3.35
J	-2.67	+6.60
K	0.00	+2.67
L	0.00	-2.34

32

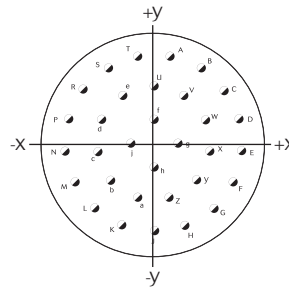

Ctc	X	y
A	+1.68	+8.97
B	+4.80	+7.75
C	+7.26	+5.51
D	+8.76	+2.49
E	+9.07	-0.84
F	+8.15	-4.06
G	+6.15	-6.73
H	+3.30	-8.51
J	0.00	-9.12
K	-3.30	-8.51
L	-6.15	-6.73
M	-8.15	-4.06
N	-9.07	-0.84
P	-8.76	+2.49
R	-7.26	+5.51
S	-4.80	+7.75

Ctc	X	y
T	-1.68	+8.97
U	0.00	+5.84
V	+3.15	+4.90
W	+5.31	+2.41
X	+5.79	-0.84
Y	+4.42	-3.84
Z	+1.65	-5.61
a	-1.65	-5.61
b	-4.42	-3.84
c	-5.79	-0.84
d	-5.31	+2.41
e	-3.15	+4.90
f	0.00	+2.44
g	+2.44	0.00
h	0.00	-2.44
j	-2.44	0.00

35

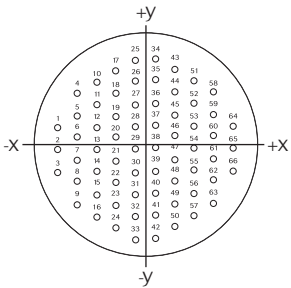

Ctc	X	y
1	-9.07	+2.29
2	-9.07	+0.08
3	-9.07	-2.29
4	-7.09	+5.72
5	-7.09	+3.43
6	-7.09	+1.14
7	-7.09	-1.14
8	-7.09	-3.43
9	-7.09	-5.72
10	-5.11	+6.86
11	-5.11	+4.57
12	-5.11	+2.29
13	-5.11	0.00
14	-5.11	-2.29

Ctc	X	y
15	-5.11	-4.57
16	-5.11	-6.86
17	-3.12	+8.00
18	+3.12	+5.72
19	-3.12	+3.43
20	-3.12	+1.14
21	-3.12	-1.14
22	-3.12	-3.43
23	-3.12	-5.72
24	-3.12	-8.00
25	-1.14	+9.14
26	-1.14	+6.86
27	-1.14	+4.57

Ctc	X	y
28	-1.14	+2.29
29	-1.14	0.00
30	-1.14	-2.29
31	-1.14	-4.57
32	-1.14	-6.86
33	-1.14	-9.14
34	+1.14	+9.14
35	+1.14	+6.86
36	+1.14	+4.57
37	+1.14	+2.29
38	+1.14	0.00
39	+1.14	-2.29
40	+1.14	-4.57

Ctc	X	y
41	+1.14	-6.86
42	+1.14	-9.14
43	+3.12	+8.00
44	+3.12	+5.72
45	+3.12	+3.43
46	+3.12	+1.14
47	+3.12	-1.14
48	+3.12	-3.43
49	+3.12	-5.72
50	+3.12	-8.00
51	+5.11	+6.86
52	+5.11	+4.57
53	+5.11	+2.29

Ctc	X	y
54	+5.11	0.00
55	+5.11	-2.29
56	+5.11	-4.57
57	+5.11	-6.86
58	+7.09	+5.72
59	+7.09	+3.43
60	+7.09	+1.14
61	+7.09	-1.14
62	+7.09	-3.43
63	+7.09	-5.72
64	+9.07	+2.29
65	+9.07	0.00
66	+9.07	-2.29

# 8LT Series

## MIL-DTL-38999 Series I

21 / G

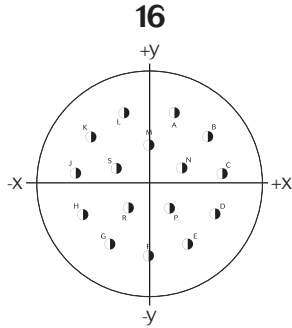

Ctc	X	y	Ctc	X	y
A	+3.00	+8.18	J	-8.66	+0.91
B	+6.88	+5.36	K	-6.88	+5.36
C	+8.66	+0.91	L	-3.00	+8.18
D	+7.82	-3.81	M	0.00	+4.45
E	+4.62	-7.37	N	+3.91	+1.57
F	0.00	-8.71	P	+2.39	-3.10
G	-4.62	-7.37	R	-2.39	-3.10
H	-7.82	-3.81	S	-3.91	+1.57

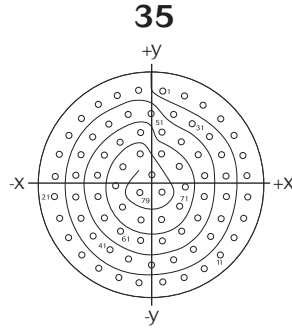

Ctc	X	y
1	+1.35	+10.82
2	+3.71	+10.26
3	+5.89	+9.19
4	+7.77	+7.67
5	+9.27	+5.77
6	+10.31	+3.58
7	+10.85	+1.22
8	+10.85	-1.22
9	+10.31	-3.58
10	+9.27	-5.77
11	+7.77	-7.67
12	+5.89	-9.19
13	+3.71	-10.26

Ctc	X	y
14	+1.35	-10.82
15	-1.35	-10.82
16	-3.71	-10.26
17	-5.89	-9.19
18	-7.77	-7.67
19	-9.27	-5.77
20	-10.31	-3.58
21	-10.85	-1.22
22	-10.85	+1.22
23	-10.31	+3.58
24	-9.27	+5.77
25	-7.77	+7.67
26	-5.89	+9.19
27	-3.71	+10.26
28	-1.35	+10.82
29	0.00	+8.20
30	+2.49	+8.18
31	+4.67	+7.11
32	+6.55	+5.59
33	+7.90	+3.58
34	+8.43	+1.22
35	+8.43	-1.22

Ctc	X	y
36	+7.90	-3.58
37	+6.55	-5.59
38	+4.67	-7.11
39	+2.49	-8.18
40	0.00	-8.81
41	-2.49	-8.18
42	-4.67	-7.11
43	-6.55	-5.59
44	-7.90	-3.58
45	-8.43	-1.22
46	-8.43	+1.22
47	-7.90	+3.58
48	-6.55	+5.59
49	-4.67	+7.11
50	-2.49	+8.18
51	-1.22	+6.12
52	+1.22	+6.12
53	+3.40	+5.05
54	+5.28	+3.53
55	+6.02	+1.22
56	+6.02	-1.22
57	+5.28	-3.53

Ctc	X	y
58	+3.40	-5.05
59	+1.22	-6.12
60	-1.22	-6.12
61	-3.40	-5.05
62	-5.28	-3.53
63	-6.02	-1.22
64	-6.02	+1.22
65	-5.28	+3.53
66	-3.40	+5.05
67	-1.22	+3.71
68	+1.22	+3.71
69	+3.18	+2.29
70	+3.94	0.00
71	+3.18	-2.29
72	+1.22	-3.71
73	-1.22	-3.71
74	-3.18	-2.29
75	-3.94	0.00
76	-3.18	+2.29
77	0.00	+1.35
78	+1.22	-0.74
79	-1.22	-0.74

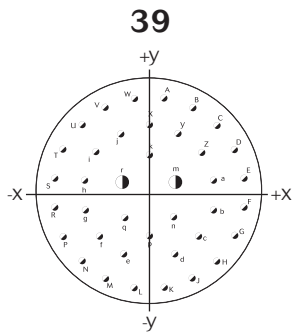

Ctc	X	y	Ctc	X	y	Ctc	X	y
A	+1.65	+10.44	P	-9.42	-4.80	d	+2.84	-6.73
B	+4.80	+9.42	R	-10.44	-1.65	e	-2.84	-6.73
C	+7.47	+7.47	S	-10.44	+1.65	f	-5.51	-4.80
D	+9.42	+4.80	T	-9.42	+4.80	g	-7.11	-1.88
E	+10.44	+1.65	U	-7.47	+7.47	h	-7.11	+1.45
F	+10.44	-1.65	V	-4.80	+9.42	i	-5.89	+4.55
G	+9.42	-4.80	W	-1.65	+10.44	j	-3.20	+6.50
H	+7.47	-7.47	X	0.00	+7.49	k	0.00	+4.17
J	+4.80	-9.42	Y	+3.20	+6.50	m	+2.90	+1.22
K	+1.65	-10.44	Z	+5.89	+4.55	n	+2.69	-2.72
L	-1.65	-10.44	a	+7.11	+1.45	p	0.00	-4.80
M	-4.80	-9.42	b	+7.11	-1.88	q	-2.69	-2.72
N	-7.47	-7.47	c	+5.51	-4.80	r	-2.90	+1.22

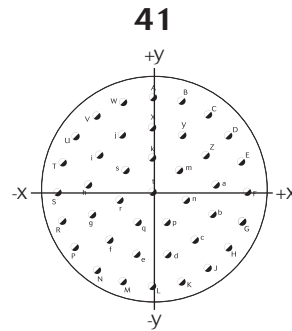

Ctc	X	y
A	0.00	+10.60
B	+3.28	+10.09
C	+6.23	+8.58
D	+8.58	+6.23
E	+10.09	+3.28
F	+10.60	0.00
G	+10.09	-3.28
H	+8.58	-6.23
J	+6.23	-8.58
K	+3.28	-10.09
L	0.00	-10.60

Ctc	X	y
M	-3.26	-10.09
N	-6.23	-8.58
P	-8.58	-6.23
R	-10.09	-3.28
S	-10.60	0.00
T	-10.09	+3.28
U	-8.58	+6.23
V	-6.23	+8.58
W	-3.28	+10.09
X	0.00	+7.20
Y	+3.35	+6.38

Ctc	X	y
Z	+5.92	+4.09
a	+7.15	+0.87
b	+6.73	-2.55
c	+4.78	-5.39
d	+1.73	-6.99
e	-1.73	-6.99
f	-4.78	-5.39
g	-6.73	-2.55
h	-7.15	+0.87
i	-5.92	+4.09
j	-3.35	+6.38
k	0.00	+3.81
m	+2.98	+2.38
n	+3.71	-0.85
p	+1.66	-3.43
q	-1.66	-3.43
r	-3.71	-0.85
s	-2.98	+2.38
t	0.00	0.00

# 8LT Series

## MIL-DTL-38999 Series I

### 23 / H

21

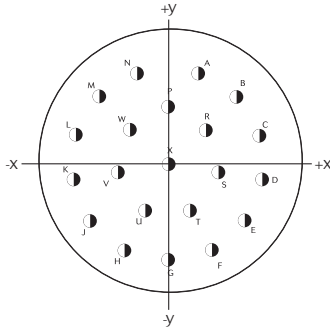

Ctc	X	y
A	+3.25	+9.78
B	+7.34	+7.24
C	+9.80	+3.12
D	+10.16	-1.65
E	+8.33	-6.07
F	+4.65	-9.19
G	0.00	-10.31
H	-4.65	-9.19
J	-8.33	-6.07
K	-10.16	-1.65
L	-9.80	+3.12
M	-7.34	+7.24
N	-3.25	+9.78
P	0.00	+6.22
R	+4.06	+3.71
S	+5.44	-0.89
T	+2.39	-4.93
U	-2.39	-4.93
V	-5.44	-0.89
W	-4.06	+3.71
X	0.00	0.00

53

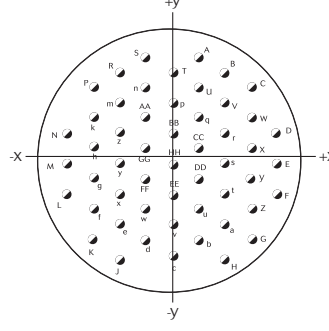

Ctc	X	y
N	-11.43	+3.30
P	-8.53	+8.26
R	-5.72	+9.91
S	-2.84	+11.56
T	0.00	+9.91
U	+2.84	+8.26
V	+5.72	+6.60
W	+8.53	+4.95
X	+8.53	+1.65
Y	+8.53	-1.65
Z	+8.53	-4.95
a	+5.72	-6.60
b	+2.84	-8.26
c	0.00	-9.91
d	-2.84	-8.26
e	-5.72	-6.60
f	-8.53	-4.95
g	-8.53	-1.65
h	-8.53	+1.65
k	-8.53	+4.95
m	-5.72	+6.60
n	-2.84	+8.26
p	0.00	+6.60
q	+2.84	+4.95
r	+5.72	+3.30
s	+5.72	0.00
t	+5.72	-3.30
u	+2.84	-4.95
v	0.00	-6.60
w	-2.84	-4.95
x	-5.72	-3.30
y	-5.72	0.00
z	-5.72	+3.30
AA	-2.84	+4.95
BB	0.00	+3.30
CC	+2.84	+1.65
DD	+2.84	-1.65
EE	0.00	-3.30
FF	-2.84	-1.65
GG	-2.84	+1.65
HH	0.00	0.00

Ctc	X	y
A	+2.84	+11.56
B	+5.72	+9.91
C	+8.53	+8.26
D	+11.43	+3.30
E	+11.43	0.00
F	+11.43	-3.30

Ctc	X	y
G	+8.53	-8.26
H	+5.72	-10.41
J	-5.72	-10.41
K	-8.53	-8.26
L	-11.43	-3.30
M	-11.43	0.00

### 25 / J

04

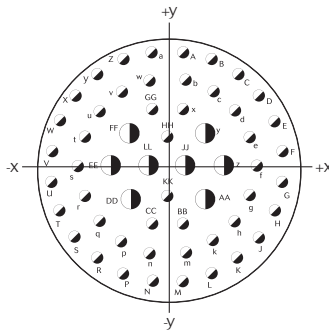

Ctc	X	y
A	+1.75	+13.49
B	+5.16	+12.57
C	+8.23	+10.80
D	+10.77	+8.28
E	+12.52	+5.21
F	+13.49	+1.75
G	+13.49	-1.75

Ctc	X	y
H	+12.52	-5.21
J	+10.77	-8.28
K	+8.23	-10.80
L	+5.16	-12.57
M	+1.75	-13.49
N	-1.75	-13.49
P	-5.16	-12.57

Ctc	X	y
R	-8.23	-10.80
S	-10.77	-8.28
T	-12.52	-5.21
U	-13.49	-1.75
V	-13.49	+1.75
W	-12.52	+5.21
X	-10.77	+8.28
Y	-8.23	+10.80
Z	-5.16	+12.57
a	-1.75	+13.49
b	+2.18	+10.08
c	+5.38	+8.78
d	+7.90	+6.38
e	+9.58	+3.35
f	+10.46	0.00
g	+9.58	-3.35
h	+7.90	-6.38
k	+5.38	-8.78
m	+2.18	-10.08
n	-2.18	-10.08
p	-5.38	-8.78

Ctc	X	y
q	-7.90	-6.38
r	-9.58	-3.35
s	-10.46	0.00
t	-9.58	+3.35
u	-7.90	+6.38
v	-5.38	+8.78
w	-2.18	+10.08
x	+1.75	+6.66
y	+4.37	+3.78
z	+6.55	0.00
AA	+4.37	-3.78
BB	+1.75	-6.66
CC	-1.75	-6.66
DD	-4.37	-3.78
EE	-6.55	0.00
FF	-4.37	-3.78
GG	-1.75	-6.66
HH	0.00	+3.35
JJ	+2.18	0.00
KK	0.00	-3.35
LL	-2.18	0.00

29

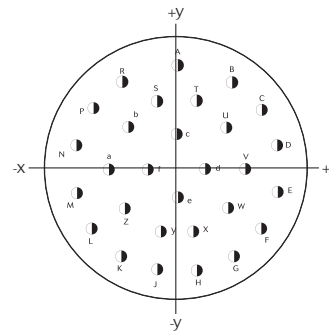

Ctc	X	y
A	0.00	+12.22
B	+6.55	+10.31
C	+10.03	+7.04
D	+11.91	+2.77
E	+11.91	-2.77
F	+10.03	-7.04
G	+6.68	-10.31
H	+2.31	-11.99

Ctc	X	y
J	-2.31	-11.99
K	-6.68	-10.31
L	-10.03	-7.04
M	-11.91	-2.77
N	-11.91	+2.77
P	-10.03	+7.04
R	-6.55	+10.31
S	-2.31	+8.15
T	+2.31	+8.15
U	+5.79	+4.93
V	+8.10	0.00
W	+6.10	-4.60
X	+2.31	-7.37
Y	-2.31	-7.37
Z	-6.10	-4.60
a	-8.10	0.00
b	-5.79	+4.93
c	0.00	+4.09
d	+3.40	0.00
e	0.00	-3.30
f	-3.40	0.00

# 8LT Series

## MIL-DTL-38999 Series I

25 / J

35

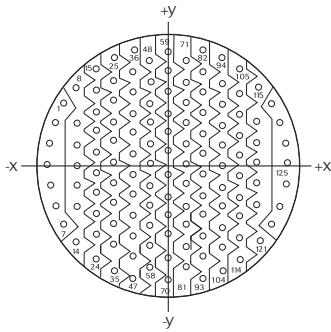

Ctc	X	y
1	-12.17	+7.09
2	-13.21	+4.83
3	-13.87	+2.41
4	-14.10	0.00
5	-13.87	-2.41
6	-13.21	-4.83
7	-12.17	-7.09
8	-10.77	+9.07
9	-10.54	+4.83
10	-10.54	+2.41
11	-10.54	0.00
12	-10.54	-2.41
13	-10.54	-4.83
14	-10.77	-9.07
15	-8.43	+11.28
16	-8.43	+8.43
17	-8.43	+6.02
18	-8.43	+3.61
19	-8.43	+1.19
20	-8.43	-1.19
21	-8.43	-3.61
22	-8.43	-6.02
23	-8.43	-8.43
24	-8.43	-10.85
25	-6.32	+12.60
26	-6.32	+9.65

Ctc	X	y
27	-6.32	+7.24
28	-6.32	+4.83
29	-6.32	+2.41
30	-6.32	0.00
31	-6.32	-2.41
32	-6.32	-4.83
33	-6.32	-7.24
34	-6.32	-9.65
35	-6.32	-12.07
36	-4.06	+13.49
37	-4.22	+10.85
38	-4.22	+8.43
39	-4.22	+6.02
40	-4.22	+3.61
41	-4.22	+1.19
42	-4.22	-1.19
43	-4.22	-3.61
44	-4.22	-6.02
45	-4.22	-8.43
46	-4.22	-10.85
47	-4.22	-13.26
48	-2.11	+12.07
49	-2.11	+9.65
50	-2.11	+7.24
51	-2.11	+4.83
52	-2.11	+2.41

Ctc	X	y
53	-2.11	0.00
54	-2.11	-2.41
55	-2.11	-4.83
56	-2.11	-7.24
57	-2.11	-9.65
58	-2.11	-12.07
59	0.00	+13.26
60	0.00	+10.85
61	0.00	+8.43
62	0.00	+6.02
63	0.00	+3.61
64	0.00	+1.19
65	0.00	-1.19
66	0.00	-3.61
67	0.00	-6.02
68	0.00	-8.43
69	0.00	-10.85
70	0.00	-14.10
71	+2.11	+12.07
72	+2.11	+9.65
73	+2.11	+7.34
74	+2.11	+4.83
75	+2.11	+2.41
76	+2.11	0.00
77	+2.11	-2.41
78	+2.11	-4.83

Ctc	X	y
79	+2.11	-7.24
80	+2.11	-9.65
81	+2.11	-12.07
82	+4.06	+13.49
83	+4.22	+10.85
84	+4.22	+8.43
85	+4.22	+6.02
86	+4.22	+3.61
87	+4.22	+1.19
88	+4.22	-1.19
89	+4.22	-3.61
90	+4.22	-6.02
91	+4.22	-8.43
92	+4.22	-10.85
93	+4.22	-13.26
94	+6.32	+12.60
95	+6.32	+9.65
96	+6.32	+7.24
97	+6.32	+4.83
98	+6.32	+2.41
99	+6.32	0.00
100	+6.32	-2.41
101	+6.32	-4.83
102	+6.32	-7.24
103	+6.32	-9.65

Ctc	X	y
104	+6.32	-12.07
105	+8.43	+11.28
106	+8.43	+8.43
107	+8.43	+6.02
108	+8.43	+3.61
109	+8.43	+1.19
110	+8.43	-1.19
111	+8.43	-3.61
112	+8.43	-6.02
113	+8.43	-8.43
114	+8.43	-10.85
115	+10.77	+9.07
116	+10.54	+4.83
117	+10.54	+2.41
118	+10.54	0.00
119	+10.54	-2.41
120	+10.54	-4.83
121	+10.77	-9.07
122	+12.17	+7.09
123	+13.21	+4.83
124	+13.87	+2.41
125	+14.10	0.00
126	+13.87	-2.41
127	+13.21	-4.83
128	+12.17	-7.09

43

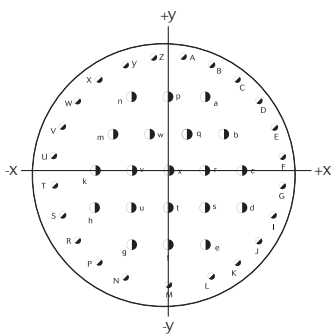

Ctc	X	y
A	+1.75	+13.49
B	+5.16	+12.57
C	+8.23	+10.80
D	+10.77	+8.28
E	+12.52	+5.21
F	+13.49	+1.75
G	+13.49	-1.75
H	+12.52	-5.21
J	+10.77	-8.28
K	+8.23	-10.80
L	+5.16	-12.57
M	0.00	-13.49
N	-5.16	-12.57
P	-8.23	-10.80
R	-10.77	-8.28
S	-12.52	-5.21
T	-13.49	-1.75
U	-13.49	+1.75
V	-12.52	+5.21
W	-10.77	+8.28
X	-8.23	+10.80
Y	-5.16	+12.57

Ctc	X	y
Z	-1.75	+13.4
a	+4.37	+8.74
b	+6.55	+4.37
c	+8.74	0.00
d	+8.74	-4.37
e	+4.37	-8.74
f	0.00	-8.74
g	-4.37	-8.74
h	-8.74	-4.37
k	-8.74	0.00
m	-6.55	+4.37
n	-4.37	+8.74
p	0.00	+8.74
q	+2.18	+4.37
r	+4.37	0.00
s	+4.37	-4.37
t	0.00	-4.37
u	-4.37	-4.37
v	-4.37	0.00
w	-2.18	+4.37
x	0.00	0.00

61

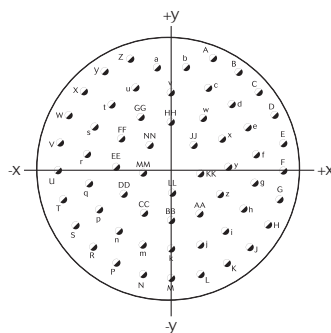

Ctc	X	y
V	-13.39	+2.57
W	-12.32	+5.84
X	-10.49	+8.71
Y	-7.98	-11.05
Z	-4.98	+12.10
a	-1.73	+11.53
b	+1.73	+11.53
c	+4.39	+9.22
d	+7.24	+7.19
e	+9.19	+4.45
f	+10.13	+1.17
g	+9.96	-2.24
h	+8.66	-5.41
i	+6.38	-7.98
j	+3.38	-9.63
k	0.00	-10.21
m	-3.38	-9.63
n	-6.38	-7.98
p	-8.66	-5.41
q	-9.96	-2.24
r	-10.13	+1.17
s	-9.19	+4.45

Ctc	X	y
t	-7.24	+7.19
u	-4.39	+9.22
v	0.00	+8.59
w	+3.73	+5.66
x	+6.02	+3.10
y	+6.78	-0.25
z	+5.79	-3.53
AA	+3.33	-5.92
BB	0.00	-6.78
CC	-3.33	-5.92
DD	-5.79	-3.53
EE	-6.78	-0.25
FF	-6.02	+3.10
GG	-3.73	+5.66
HH	0.00	+5.08
JJ	+2.67	+2.39
KK	+3.43	-1.04
LL	0.00	-3.35
MM	-3.43	-1.04
NN	-2.67	+2.39
PP	0.00	0.00

Ctc	X	y
A	+4.98	+12.70
B	+7.98	+11.05
C	+10.49	+8.71
D	+12.32	+5.84
E	+13.39	+2.57
F	+13.61	-0.76
G	+12.98	-4.17
H	+11.53	-7.29
J	+9.35	-9.93

Ctc	X	y
K	+6.58	-11.94
L	+3.40	-13.18
M	0.00	-13.64
N	-3.40	-13.18
P	-6.58	-11.94
R	-9.35	-9.93
S	-11.53	-7.29
T	-12.98	-4.17
U	-13.61	-0.76

8  
BIT  
Series.





8LT Series

# Range Extension

■ micro38999 .....	62
■ RoHS solution .....	62
■ High density .....	63
■ PCB contact without shoulder .....	63



# 8LT Series

## MIL-DTL-38999 Series I

### Product range extension

## micr 38999

**A complete miniature range: threaded (8DA), break away (8BA) & bayonet (8LTA). Space saving with scoop proof connector for harsh applications.**

**A compact solution:**

- . Diameter up to 45% smaller than size 9 (D38999).
- . Up to 50% shorter.
- . Integrated backshell: Cost and space saving.

**A high density solution:**

- . With #26 contacts (according to 39029).
- . 5 layouts (size 3, 5 and 7 with #22 & #26).

**Excellent features:**

- . Designed for D38999 requirements.
- . IP67 sealing when mated.
- . Stainless steel shell (1500 matings) & aluminum shell (500 matings).

**RoHS and Cadmium free:**

- . Available in zinc nickel (RoHS) plating, as well as nickel and olive drab cadmium.



## RoHS Solution

**The RoHS alternative to cadmium !  
SOURIAU Zinc Nickel: the best in terms of price and performance for aerospace & defense equipment.**

**SOURIAU Black Zinc Nickel:**

- . A unique alternative plating process to cadmium.

**RoHS compliant:**

- . A unique SOURIAU plating process compliant with RoHS regulations for cadmium and Cr6+.

**The first QPL qualified:**

- . SOURIAU Zn Ni is the first product which has been qualified by US Defense standards organization (DLA Land and Maritime).

**High corrosion resistance:**

- . 500 hours salt spray.

**Available in mass production:**

- . Available for 38999 Series I, II and III aluminum range.



# 8LT Series

## MIL-DTL-38999 Series I

### Product range extension

#### High Density

**SOURIAU offers a robust & reliable High Density solution derived from 38999 Series I, Series III & VG96912.**

**3 shell sizes available:**

- . Provides flexibility according to your application.

**A reliable & robust solution:**

- . Same well proven design as standard 38999 & VG96912.

**Significant space saving:**

- . Twice the number of contacts compared to size 13-35 with 22 contacts.
- . Two shell sizes smaller than a partially populated size 17-35 with 55 cavities.



See «High Density Connectors» product news on [www.souriau.com](http://www.souriau.com)

#### PCB Contact without Shoulder

**Pin & socket PCB contacts without shoulder #22D & #20 as per MIL-DTL-38999 Series I, II & III.**  
**Contacts without shoulder allows a more flexible mounting on variable PCB thicknesses or depths.**

**Ruggedized contacts:**

- . Material: copper alloy
- . Finish: gold per MIL-G-45204 type I class 1 over nickel plate
- . Sleeve: stainless steel

**Flexible mounting:**

- . Various PCB thicknesses.
- . Multiple PCB positioning.



See «PCB contacts without shoulder» product news on [www.souriau.com](http://www.souriau.com)

# Reliable People, Reliable Solutions



Your local contact



Our contribution to environmental protection:  
This catalog is printed on PEFC certified paper  
Advancement of sustainable wood cultivation. [www.pefc.org](http://www.pefc.org)

[www.esterline-connection-technologies.com](http://www.esterline-connection-technologies.com)  
[technical-emear-ect@esterline.com](mailto:technical-emear-ect@esterline.com) (Europe - Asia - Africa)  
[technical-americas-ect@esterline.com](mailto:technical-americas-ect@esterline.com) (North America)



## SOURIAU

## X-ON Electronics

Largest Supplier of Electrical and Electronic Components

*Click to view similar products for [Circular MIL Spec Connector](#) category:*

*Click to view products by [Sunbank](#) manufacturer:*

Other Similar products are found below :

[89075GULPR](#) [0025-264-3014](#) [58-570121-04S](#) [58-584653-12P](#) [0134-213-1007](#) [0134-213-1208](#) [0134-213-2209](#) [0025-258-000](#) [60-042022-02P](#) [60-042022-19P](#) [60-042022-23P](#) [60-042217-10P](#) [60-042217-11P](#) [012-0467-000](#) [602GB06EG24-61SN](#) [0134-201-1207](#) [0134-207-2009](#) [0134-213-1006](#) [6104-207-2302](#) [6104-208-1902](#) [6131-202-19149P](#) [6131-204-21149P](#) [6131-207-13149P](#) [6131-208-13149P](#) [6131-209-17149P](#) [6131-210-11149P](#) [6131-211-19149P](#) [6131-216-19149P](#) [6131-220-25149P](#) [6131-259-11149P](#) [6131-259-21149P](#) [6131-259-23149P](#) [6131-263-19149P](#) [6131-265-17149P](#) [6131-265-19149P](#) [6134-203-21149](#) [CS3100A18-1P-472](#) [CS3100A-36-77S](#) [CS3101A36-79S-SR](#) [CS3102A-10SL-53P](#) [CS3102A10SL-64S](#) [CS3102A-18-1P116](#) [CS3102A-20-15S](#) [CS3102A-22-70S](#) [CS3102A-24-79S](#) [CS3102A24-AJS](#) [CS3102A-32-17P](#) [CS3102A32-25S](#) [CS3102A-36-78S](#) [CS3106A10SL3S004](#)