

SC24M1\* / SC24M1\*REV

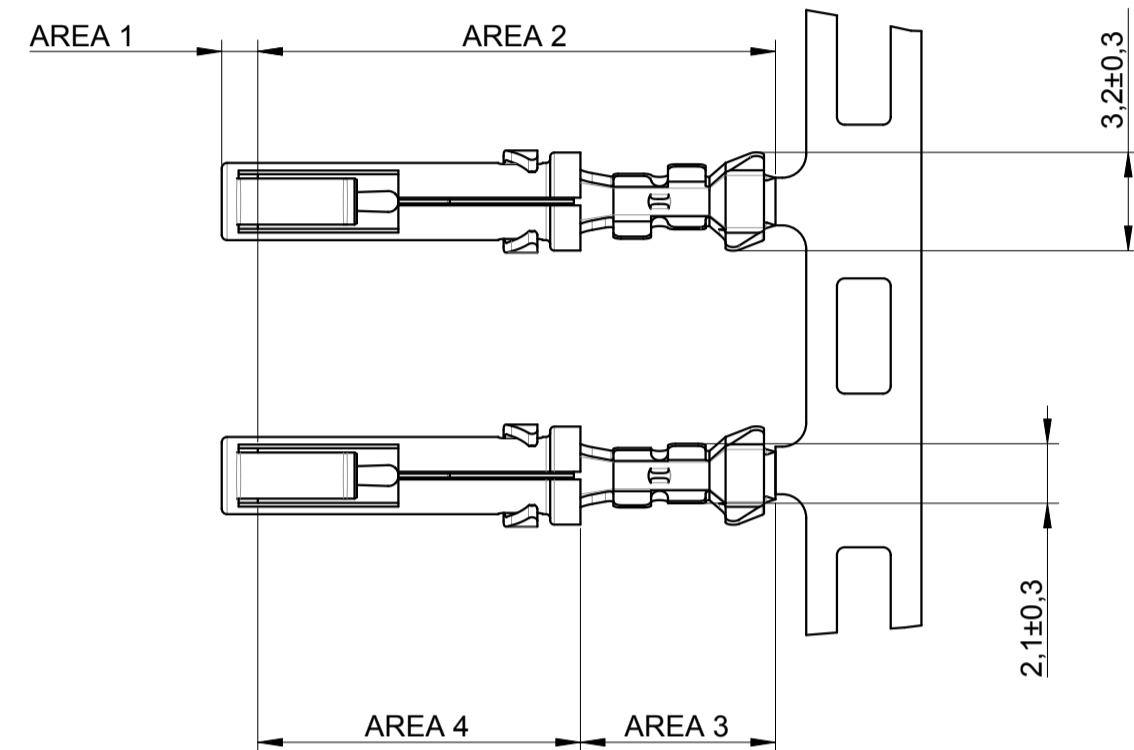

SC20M1\* / SC20M1\*REV

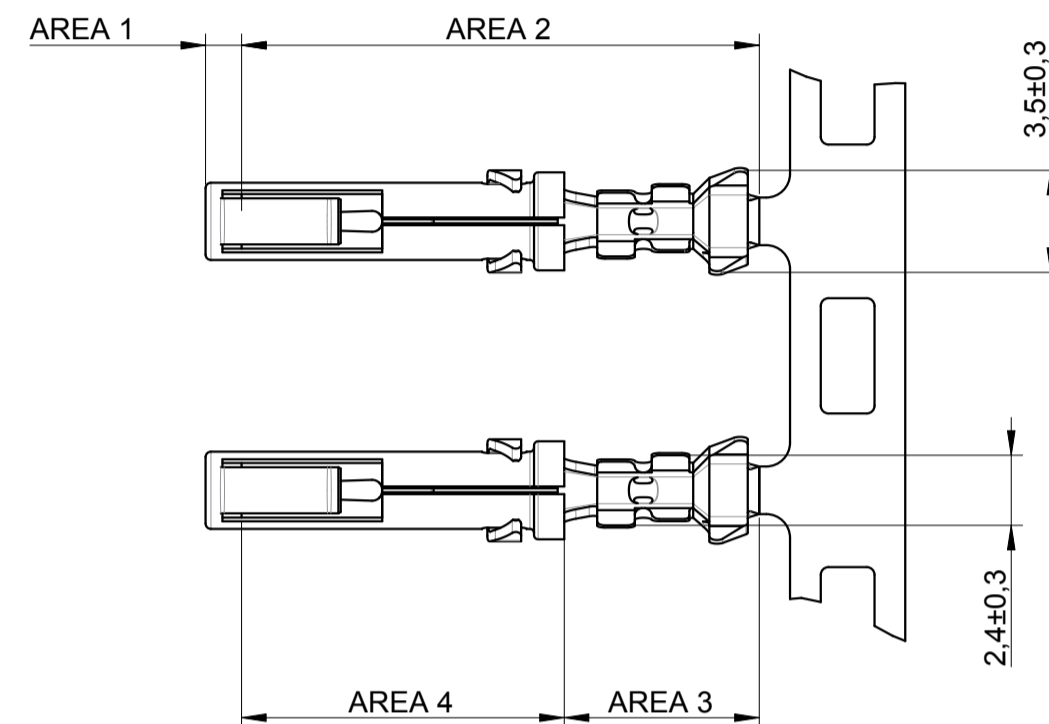

SC16M11\* / SC16M11\*REV

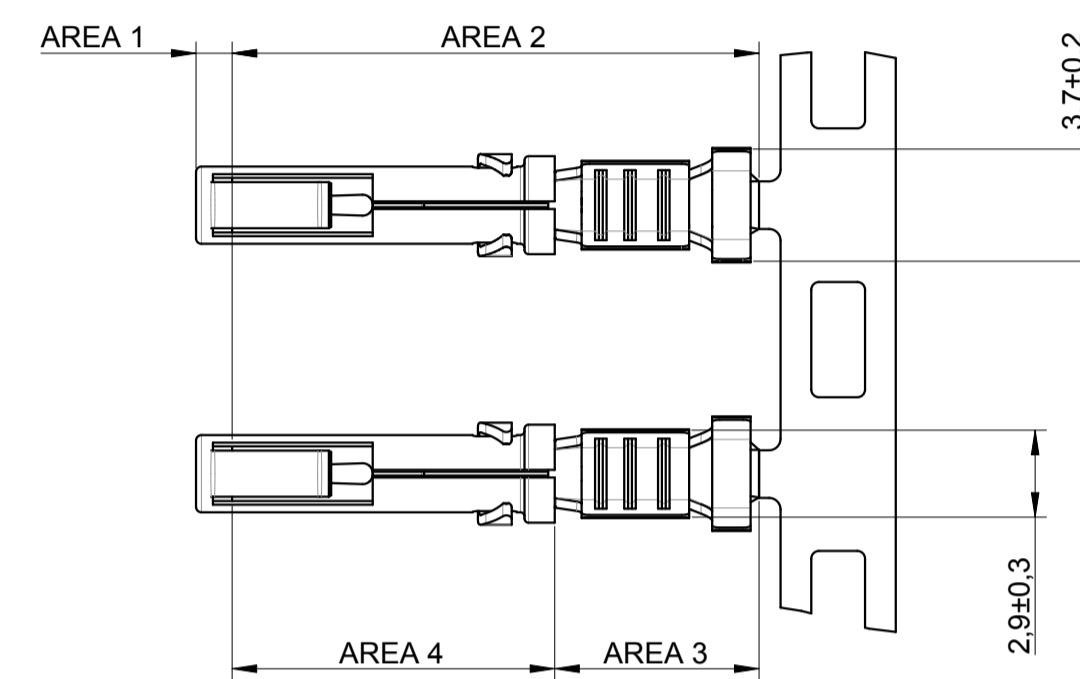

SC16M1\* / SC16M1\*REV

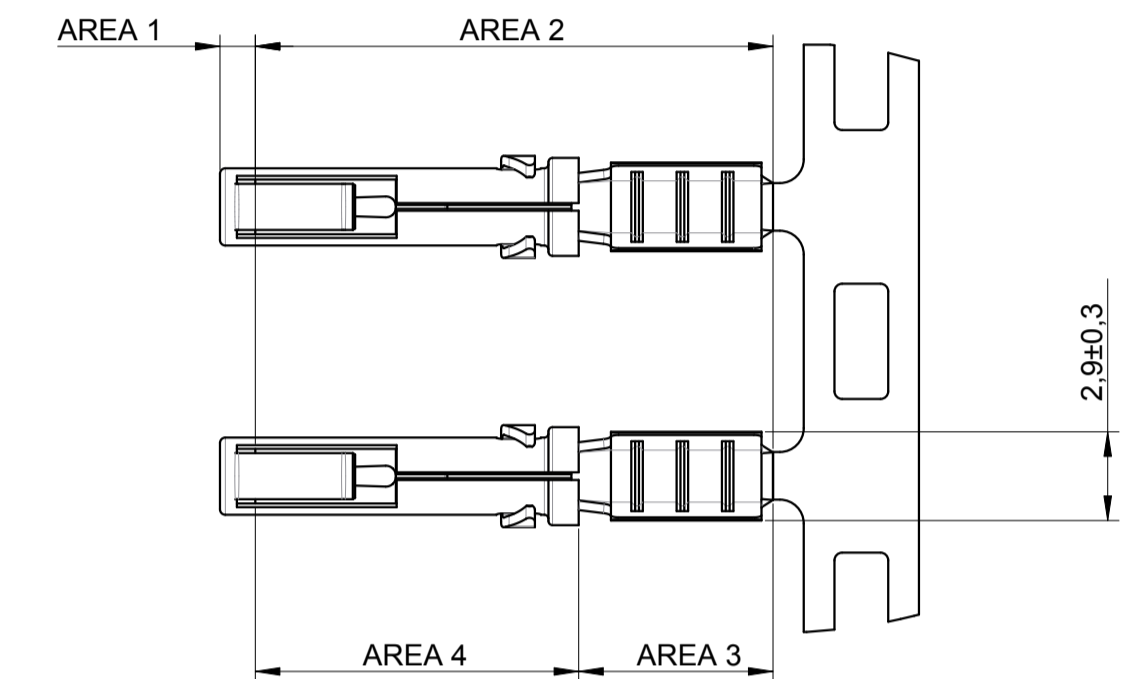

SC14ML1\*

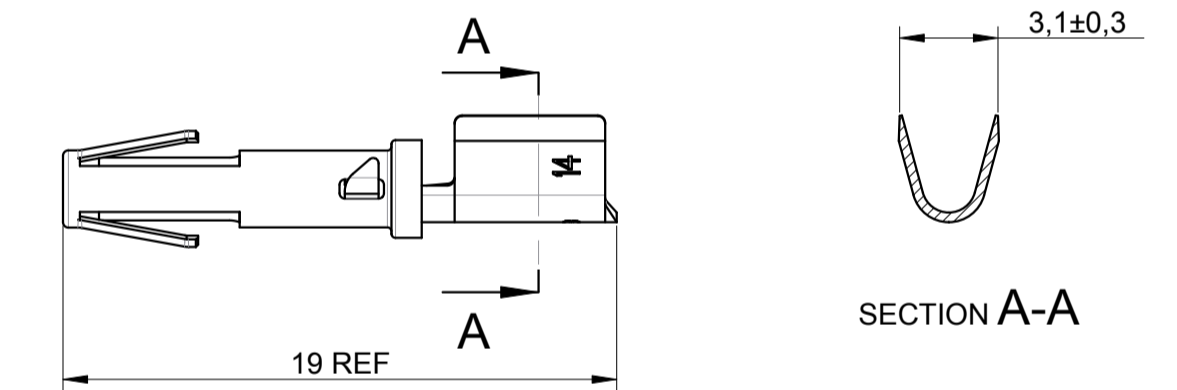

SC14M1\* / SC14M1\*REV

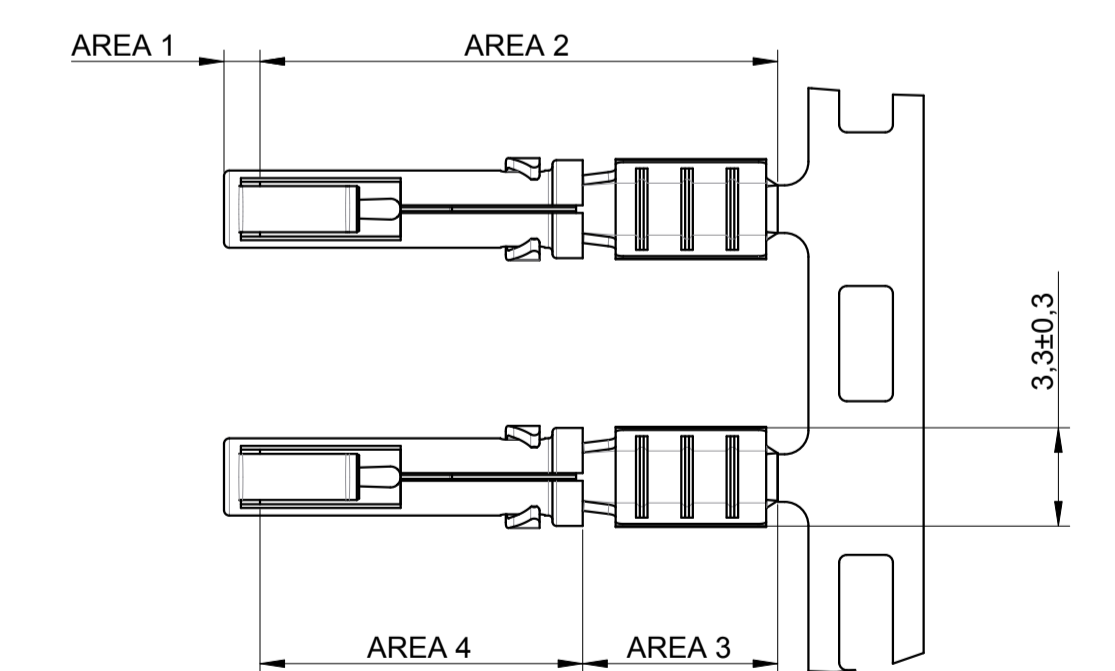

FEMALE CONTACT CAT. N°	Packaging	WIRE SIZE		WIRE INSUL. DIAM. IN MM.	WIRE STRIP LENGTH IN MM.	HAND CRIMP TOOLING		EXTRACTION TOOL
		AWG	MM²			DIE SET	HANDTOOL FOR LOOSE PIECE	
SC24ML1*	Loose contacts in platic bag	26/24	0.12/0.25	0.90/1.60	4.0	S16SCM20	SHANDLES	RX2025GE1
SC24M1* / SC24M1*REV	Strip contacts on reel							
SC20ML1*	Loose contacts in platic bag	22/20	0.32/0.50	1.20/2.10	4.0	S16SCM20	SHANDLES	
SC20M1* / SC20M1*REV	Strip contacts on reel							
SC16ML11*	Loose contacts in platic bag	18/16	0.82/1.50	3.0 Max	4.65	S16SCML11	SHANDLES	
SC16M11* / SC16M11*REV	Strip contacts on reel							
SC16ML1*	Loose contacts in platic bag	18/16	0.82/1.50	3.2 Max	6.35	S16SCML1	SHANDLES	
SC16M1* / SC16M1*REV	Strip contacts on reel							
SC14ML1*	Loose contacts in platic bag	14	2.10/2.50	3.2 Max	6.35	S16SCML1	SHANDLES	
SC14M1* / SC14M1*REV	Strip contacts on reel							

**\* PLATING**

- S6 = 0.75µ GOLD MIN. OVER Ni GOLD FLASH OVER Ni	(AREA 1) (AREA 2)	For standard winding	See View
- D70 = 0.13µ GOLD MIN. OVER Ni GOLD FLASH OVER Ni	(AREA 1) (AREA 2)		
- TK6 = 0.5-2.5µ Sn PRE-PLATED	(AREA 1+2)		
- S18 = 0.75µ GOLD MIN OVER Ni 1.3µ MINI Sn OVER Ni 1.3µ MINI Ni	(AREA 1) (AREA 3) (AREA 4)	For standard winding only	See View
- S31 = GOLD FLASH OVER Ni 1.3µ MINI Sn OVER Ni 1.3µ MINI Ni	(AREA 1) (AREA 3) (AREA 4)		
- D70REV = 0.13µ GOLD MIN. OVER Ni 1.3µ MINI Sn OVER Ni 1.3µ MINI Ni	(AREA 1) (AREA 3) (AREA 4)	For reverse winding only	

**CONSTRUCTION :**

CONTACT BODY : HIGH CONDUCTIVITY COPPER ALLOY.  
OUTER SPRING : STAINLESS STEEL.  
PACKING CONTACTS ON STANDARD STRIP : 3000 PCS. PER REEL, E.G. SC16M11\*  
PACKING CONTACTS ON REVERSE STRIP : 3000 PCS. PER REEL, E.G. SC16M11\*REV  
FOR WINDING DIRECTION ON REEL (STANDARD OR REVERSE) : SEE BS.C.200178.004  
PACKING LOOSE PIECE CONTACTS : 100 PCS PER STD. PACKING E.G. SC16ML11\*

**CONNECTOR ACCOMMODATION**

THESE CONTACTS CAN BE USED IN ANY CONTACT POSITION IN ANY CONNECTOR IN THE TRIM TRIO INTERCONNECTION SYSTEM : MSM - MSG - MB RECTANGULAR CONN. , SMS QIKMATE CONN. , UTO - UTS - UTL - UTG AND UTP - MBG CIRCULAR CONN.

**PERFORMANCE CHARACTERISTICS**

CURRENT RATING : 13 A CONTACT RETENTION IN BODY : 65 N MIN.  
CONTACT RESISTANCE : <= 6m Ohm INDIVIDUAL INSERTION FORCE : 3.5 N MAX.  
OPERATING VOLTAGE : 750 V RMS INDIVIDUAL WITHDRAWAL FORCE : 0.55 N MIN.

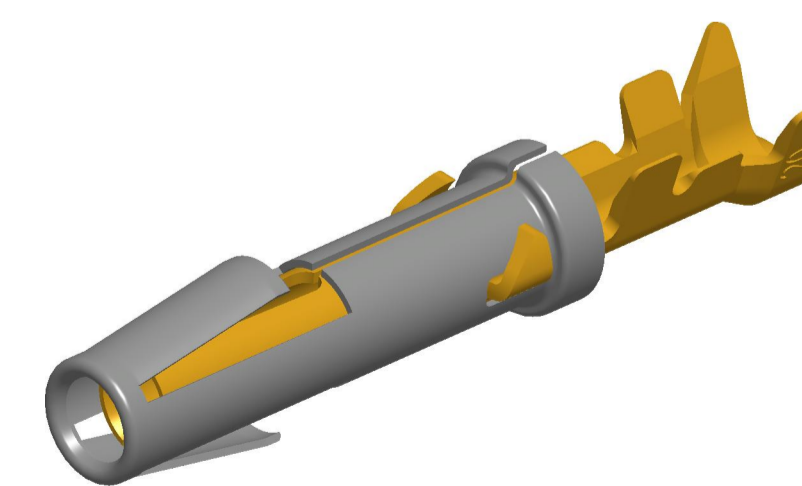

ECHELLE 7/1

SOURIAU shall not be liable for any non-conformity or damage due to a use of the Products which does not comply with the Specifications issued by either of the Parties or by a third party (professional recommendation, technical notice.)

B	05/08/2019	Update of the dimensions for the "U" shape		
ISS	DATE	Update drawing		MOD N°
Designed by:	COURTOIS L.	Date:	03/04/2019	ROUILLARD Ch
CUSTOMER DRAWING				
TITLE				
FEMALE FORMED TWO PIECE CONTACT				
SC-M--				
Scale	4/1	Dimensions in mm	NPRDS / PROJECT	
		General linear	TRIM TRIO	
		Tolerances:		
		±		
SOURIAU		www.esterline-connection-technologies.com		This document is the property of SOURIAU
FORMAT		SOURIAU DRG N°		It must not be reproduced or communicated without permission
A1		BS-C-200178-002		SHEET
				1 / 1

## X-ON Electronics

Largest Supplier of Electrical and Electronic Components

*Click to view similar products for [Crimpers / Crimping Tools](#) category:*

*Click to view products by [Sunbank](#) manufacturer:*

Other Similar products are found below :

[010-0096](#) [M225201-06](#) [M225202-37](#) [6-1579015-5](#) [CT150-6-RH07](#) [622-6441LF](#) [M322](#) [6-304052-1](#) [63456-0054](#) [63484-3701](#) [63800-8355](#)  
[63819-1875](#) [63819-2875](#) [63819-4475](#) [63823-3475](#) [63827-5375](#) [64001-0975](#) [64001-4175](#) [64005-0175](#) [662903-2](#) [690602-6](#) [7-1579001-9](#) [7-](#)  
[23471-1](#) [762637-1](#) [808714-1](#) [811242-5](#) [999-50-020083](#) [1-21002-3](#) [1-21002-7](#) [12085270](#) [1-21002-6](#) [1-21113-6](#) [1-22548-4](#) [125442-1](#)  
[DCE.91.073.BVC](#) [DCE.91.090.3MVM](#) [DCE.91.130.5MVU](#) [DCE.91.202.BVCM](#) [1338300-1](#) [1-354003-0](#) [1338301-1](#) [DF62/RE-MD](#) [142321](#)  
[1456088-1](#) [1490794-1](#) [1-45804-6](#) [1490357-2](#) [1490357-3](#) [AX100749](#) [1-59619-7](#)